



flow PACK 0

600 V / 15 A

Features

- 2 clip housing in 12 mm and 17 mm height
- Trench Fieldstop IGBT<sup>3</sup> technology
- Compact and low inductance design
- Built-in NTC

Target Applications

- Motor Drives
- Power Generation
- UPS

Types

- V23990-P862-F49-PM
- V23990-P862-F48-PM

flow 0 housing

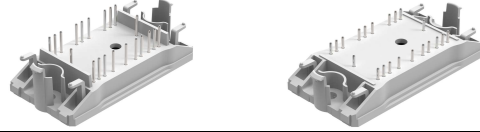

Schematic

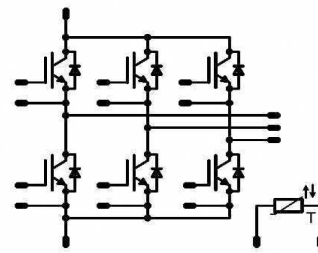

### Maximum Ratings

$T_j = 25\text{ °C}$ , unless otherwise specified

Parameter	Symbol	Condition	Value	Unit
<b>Inverter Transistor</b>				
Collector-emitter voltage	$V_{CE}$		600	V
DC collector current	$I_C$		15	A
Repetitive peak collector current	$I_{CRM}$	$t_p$ limited by $T_{jmax}$	45	A
Power dissipation	$P_{tot}$	$T_j = T_{jmax}$ $T_s = 80\text{ °C}$	46	W
Gate-emitter peak voltage	$V_{GE}$		±20	V
Short circuit ratings*	$t_{SC}$ $V_{CC}$	$T_j \leq 150\text{ °C}$ $V_{GE} = 15\text{ V}$	6 360	µs V
Maximum Junction Temperature	$T_{jmax}$		175	°C

\* It is recommended to not exceed 1000 short circuit situations in the lifetime of the module and to allow at least 1s between short circuits

**Inverter Diode**

Peak Repetitive Reverse Voltage	$V_{RRM}$		600	V
DC forward current	$I_F$		15	A
Repetitive peak forward current	$I_{FRM}$	$t_p$ limited by $T_{jmax}$	30	A
Power dissipation	$P_{tot}$	$T_j = T_{jmax}$ $T_s = 80\text{ °C}$	37	W
Maximum Junction Temperature	$T_{jmax}$		175	°C

**Thermal properties**

Storage temperature	$T_{stg}$		-40.....+125	°C
Operation junction temperature	$T_{op}$		-40.....+ $T_{jmax}$ -25	°C

**Maximum Ratings** $T_i = 25\text{ °C}$ , unless otherwise specified

Parameter	Symbol	Condition	Value	Unit
<b>Insulation properties</b>				
Insulation voltage	$V_{isol}$	DC Test Voltage* $t_p = 2\text{ s}$	6000	V
		AC Voltage $t_p = 1\text{ min}$	2500	V
Creepage distance			min.12,7	mm
Clearance		12mm height	9,22	mm
		17mm height	min.12,7	mm
Comparative Tracking Index	CTI		>200	

\*100% tested in production

### Characteristic Values

Parameter	Symbol	Conditions					Value			Unit
		$V_{GS}$ [V]	$V_{GE}$ [V]	$V_{CE}$ [V]	$I_C$ [A]	$T_j$ [°C]	Min	Typ	Max	
<b>Inverter Transistor</b>										
Gate emitter threshold voltage	$V_{GE(th)}$	$V_{CE} = V_{GE}$			0,00021	25	5	5,8	6,5	V
Collector-emitter saturation voltage	$V_{CESat}$		15			25 150		1,59 1,85	2,1	V
Collector-emitter cut-off current incl. Diode	$I_{CES}$		0	600		25			110	µA
Gate-emitter leakage current	$I_{GES}$		20	0		25			350	nA
Integrated Gate resistor	$R_{gint}$							none		Ω
Turn-on delay time	$t_{d(on)}$	$R_{gon} = 32 \Omega$ $R_{goff} = 32 \Omega$	±15	300	15	25		106		ns
Rise time	$t_r$					150		105		
Turn-off delay time	$t_{d(off)}$					25		134		
Fall time	$t_f$					150		155		
Turn-on energy loss	$E_{on}$					25		0,28		
Turn-off energy loss	$E_{off}$					150		0,38		
Input capacitance	$C_{ies}$	$f = 1 \text{ MHz}$	0	25	25			860		pF
Output capacitance	$C_{oss}$							55		
Reverse transfer capacitance	$C_{rss}$							24		
Gate charge	$Q_G$		15	480	15	25		87		nC
Thermal resistance chip to heatsink	$R_{th(j-s)}$	$\lambda_{paste} = 0,8 \text{ W/mK}$ (P12)						2,08		K/W
<b>Inverter Diode</b>										
Diode forward voltage	$V_F$				15	25 150		1,60 1,51	2,3	V
Peak reverse recovery current	$I_{RRM}$	$R_{gon} = 32 \Omega$	±15	300	15	25		11,3		A
Reverse recovery time	$t_{rr}$					150		16,1		
Reverse recovered charge	$Q_{rr}$					25		180		
Peak rate of fall of recovery current	$(di_{rr}/dt)_{max}$					150		272		
Reverse recovered energy	$E_{rec}$					25		0,71		
						150		1,45		
Thermal resistance chip to heatsink	$R_{th(j-s)}$	$\lambda_{paste} = 0,8 \text{ W/mK}$ (P12)						0,31		mWs
								2,54		K/W
<b>Thermistor</b>										
Rated resistance	$R$					25		22		kΩ
Deviation of $R_{100}$	$\Delta_{R/R}$	$R_{100} = 1486 \Omega$				100	-5		+5	%
Power dissipation	$P$					25		210		mW
Power dissipation constant						25		4,4		mW/K
B-value	$B_{(25/50)}$	Tol. -13,1%				25		3940		K
B-value	$B_{(25/100)}$	Tol. +11,6%				25		4000		K
Vincotech NTC Reference									A	



# Output Inverter

**figure 1** IGBT

**Typical output characteristics**

$I_C = f(V_{CE})$

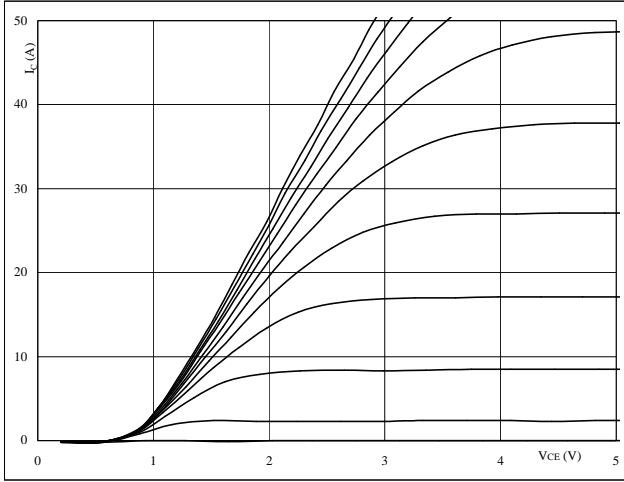

$t_p = 250 \mu s$   
 $T_j = 25 \text{ }^\circ C$   
 $V_{GE}$  from 7 V to 17 V in steps of 1 V

**figure 2** IGBT

**Typical output characteristics**

$I_C = f(V_{CE})$

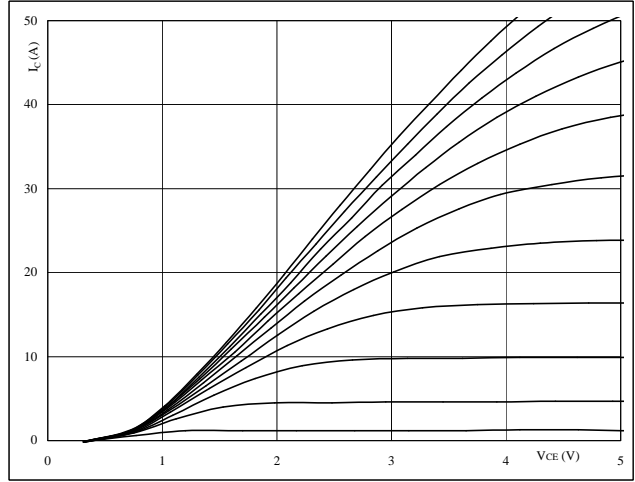

$t_p = 250 \mu s$   
 $T_j = 150 \text{ }^\circ C$   
 $V_{GE}$  from 7 V to 17 V in steps of 1 V

**figure 3** IGBT

**Typical transfer characteristics**

$I_C = f(V_{GE})$

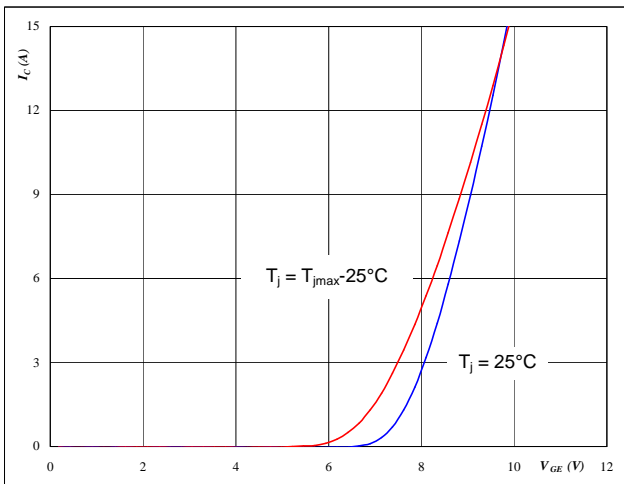

$t_p = 250 \mu s$   
 $V_{CE} = 10 V$

**figure 4** FWD

**Typical diode forward current as a function of forward voltage**

$I_F = f(V_F)$

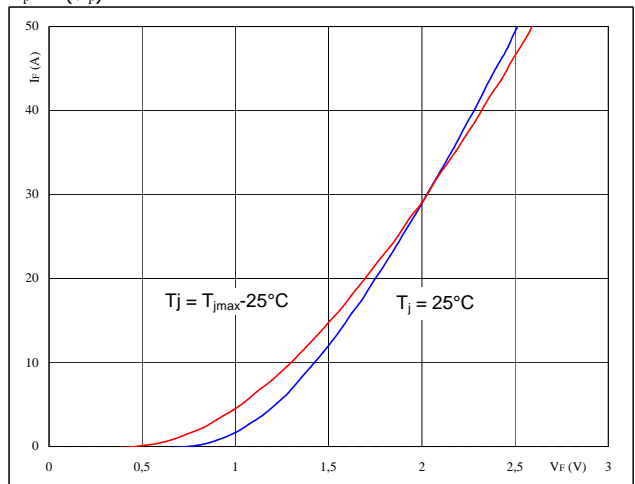

$t_p = 250 \mu s$



### Output Inverter

**figure 5** IGBT

**Typical switching energy losses as a function of collector current**

$E = f(I_C)$

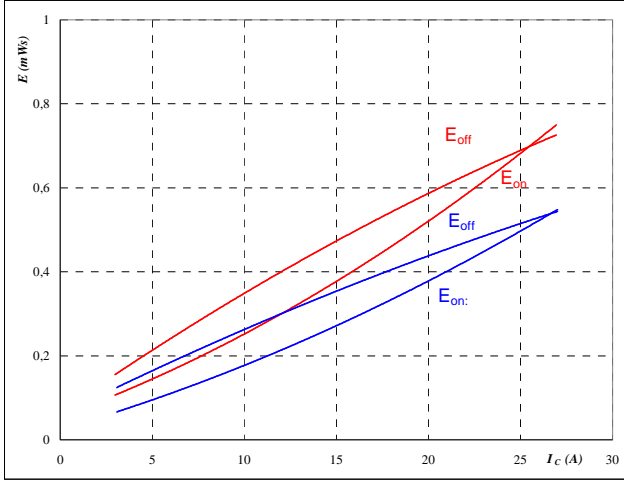

inductive load  
 $T_j = 25/150 \text{ } ^\circ\text{C}$   
 $V_{CE} = 300 \text{ V}$   
 $V_{GE} = \pm 15 \text{ V}$   
 $R_{gon} = 32 \text{ } \Omega$   
 $R_{goff} = 32 \text{ } \Omega$

**figure 6** IGBT

**Typical switching energy losses as a function of gate resistor**

$E = f(R_G)$

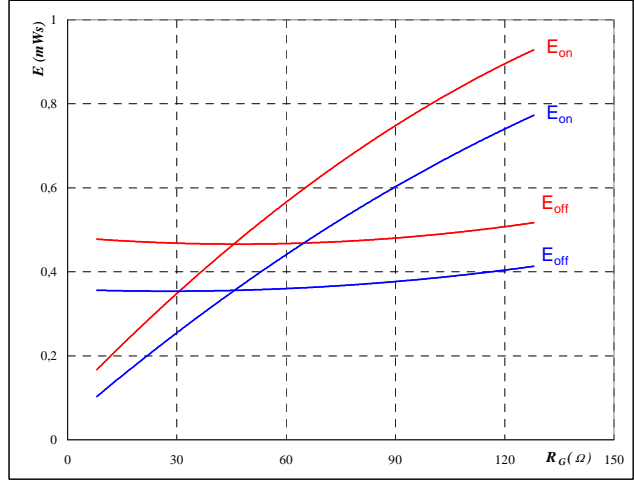

inductive load  
 $T_j = 25/150 \text{ } ^\circ\text{C}$   
 $V_{CE} = 300 \text{ V}$   
 $V_{GE} = \pm 15 \text{ V}$   
 $I_C = 15 \text{ A}$

**figure 7** IGBT

**Typical reverse recovery energy loss as a function of collector current**

$E_{rec} = f(I_C)$

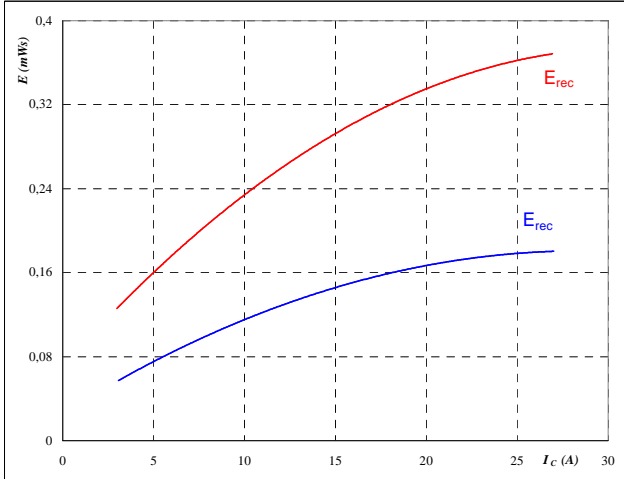

inductive load  
 $T_j = 25/150 \text{ } ^\circ\text{C}$   
 $V_{CE} = 300 \text{ V}$   
 $V_{GE} = \pm 15 \text{ V}$   
 $R_{gon} = 32 \text{ } \Omega$

**figure 8** IGBT

**Typical reverse recovery energy loss as a function of gate resistor**

$E_{rec} = f(R_G)$

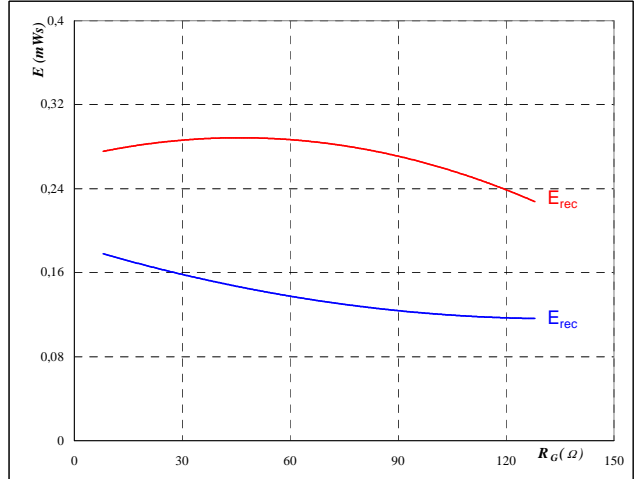

inductive load  
 $T_j = 25/150 \text{ } ^\circ\text{C}$   
 $V_{CE} = 300 \text{ V}$   
 $V_{GE} = \pm 15 \text{ V}$   
 $I_C = 15 \text{ A}$



## Output Inverter

**figure 9** IGBT

Typical switching times as a function of collector current

$$t = f(I_C)$$

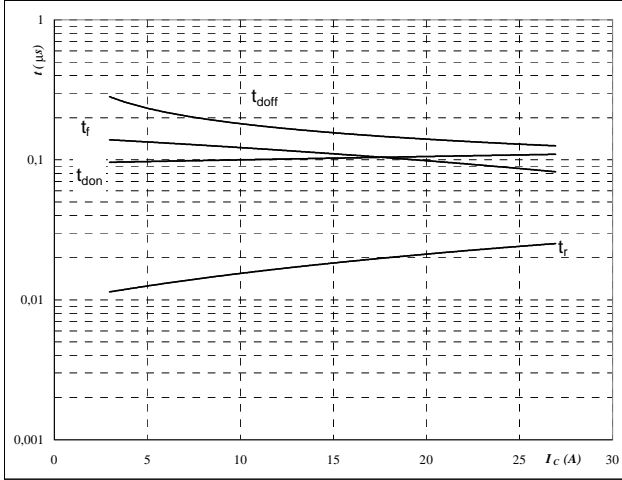

inductive load  
 $T_j = 150$  °C  
 $V_{CE} = 300$  V  
 $V_{GE} = \pm 15$  V  
 $R_{gon} = 32$  Ω  
 $R_{goff} = 32$  Ω

**figure 10** IGBT

Typical switching times as a function of gate resistor

$$t = f(R_G)$$

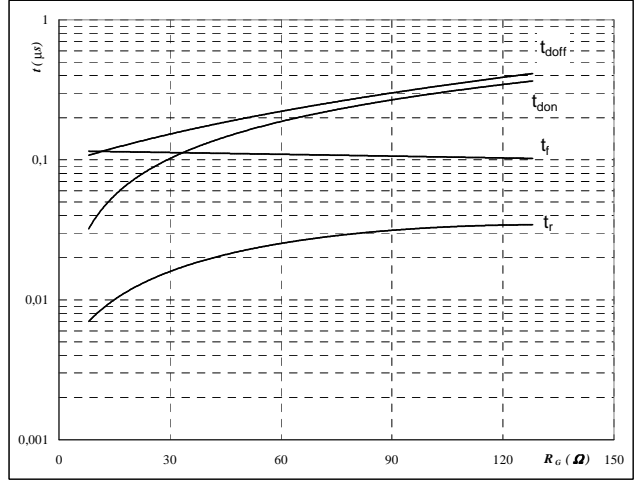

inductive load  
 $T_j = 150$  °C  
 $V_{CE} = 300$  V  
 $V_{GE} = \pm 15$  V  
 $I_C = 15$  A

**figure 11** FWD

Typical reverse recovery time as a function of collector current

$$t_{rr} = f(I_C)$$

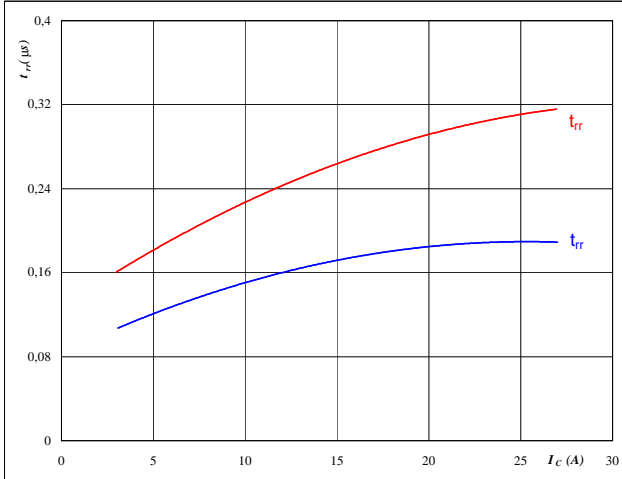

$T_j = 25/150$  °C  
 $V_{CE} = 300$  V  
 $V_{GE} = \pm 15$  V  
 $R_{gon} = 32$  Ω

**figure 12** FWD

Typical reverse recovery time as a function of IGBT turn on gate resistor

$$t_{rr} = f(R_{gon})$$

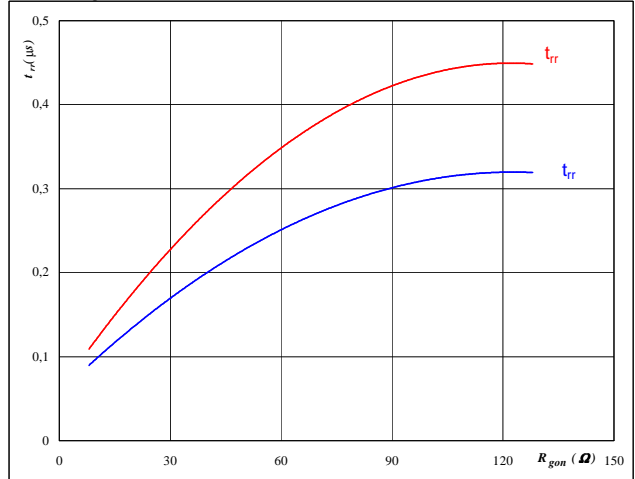

$T_j = 25/150$  °C  
 $V_R = 300$  V  
 $I_F = 15$  A  
 $V_{GE} = \pm 15$  V



### Output Inverter

**figure 13** FWD

Typical reverse recovery charge as a function of collector current

$Q_{rr} = f(I_C)$

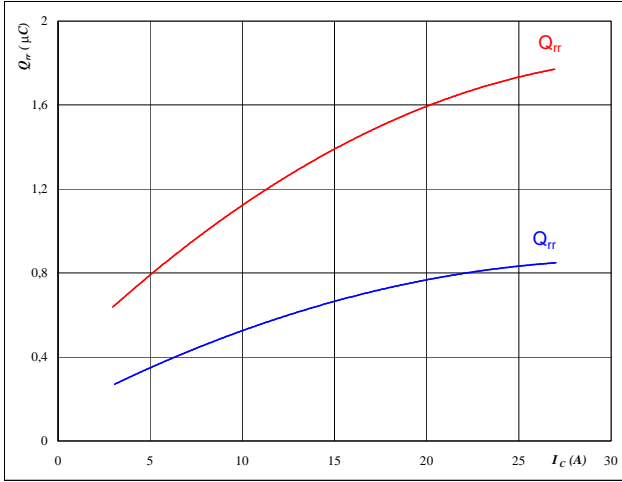

$T_j = 25/150 \text{ } ^\circ\text{C}$   
 $V_{CE} = 300 \text{ V}$   
 $V_{GE} = \pm 15 \text{ V}$   
 $R_{gon} = 32 \text{ } \Omega$

**figure 14** FWD

Typical reverse recovery charge as a function of IGBT turn on gate resistor

$Q_{rr} = f(R_{gon})$

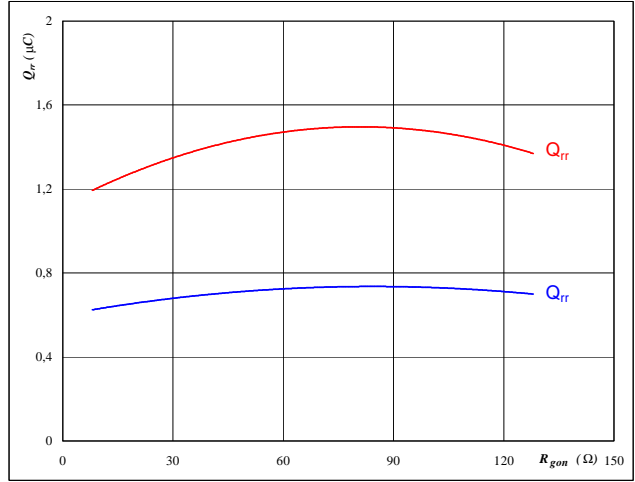

$T_j = 25/150 \text{ } ^\circ\text{C}$   
 $V_R = 300 \text{ V}$   
 $I_F = 15 \text{ A}$   
 $V_{GE} = \pm 15 \text{ V}$

**figure 15** FWD

Typical reverse recovery current as a function of collector current

$I_{RRM} = f(I_C)$

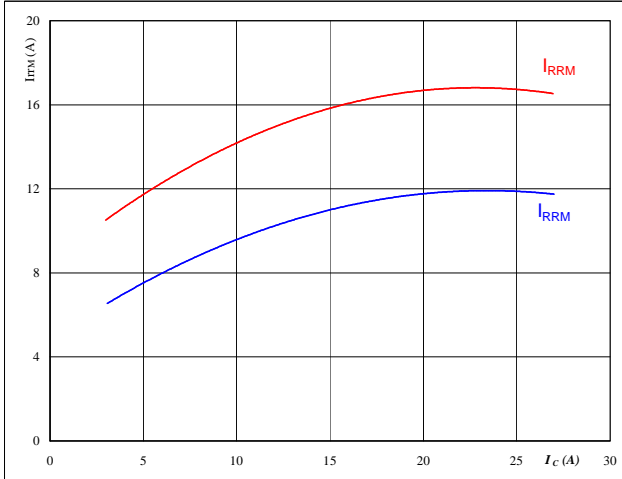

$T_j = 25/150 \text{ } ^\circ\text{C}$   
 $V_{CE} = 300 \text{ V}$   
 $V_{GE} = \pm 15 \text{ V}$   
 $R_{gon} = 32 \text{ } \Omega$

**figure 16** FWD

Typical reverse recovery current as a function of IGBT turn on gate resistor

$I_{RRM} = f(R_{gon})$

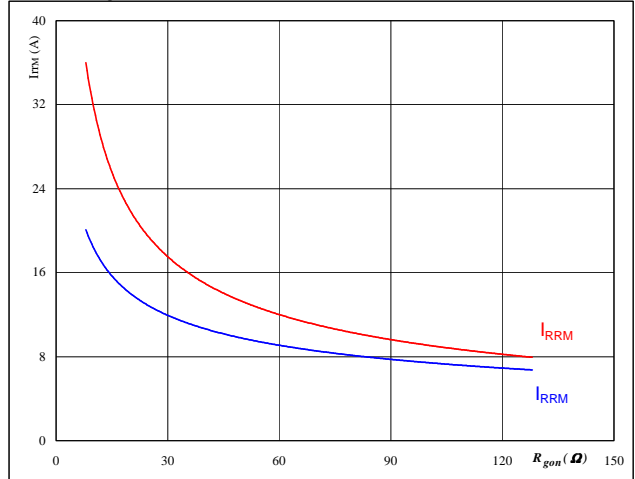

$T_j = 25/150 \text{ } ^\circ\text{C}$   
 $V_R = 300 \text{ V}$   
 $I_F = 15 \text{ A}$   
 $V_{GE} = \pm 15 \text{ V}$



# Output Inverter

**figure 17** FWD

**Typical rate of fall of forward and reverse recovery current as a function of collector current**

$$dI_0/dt, dI_{rec}/dt = f(I_C)$$

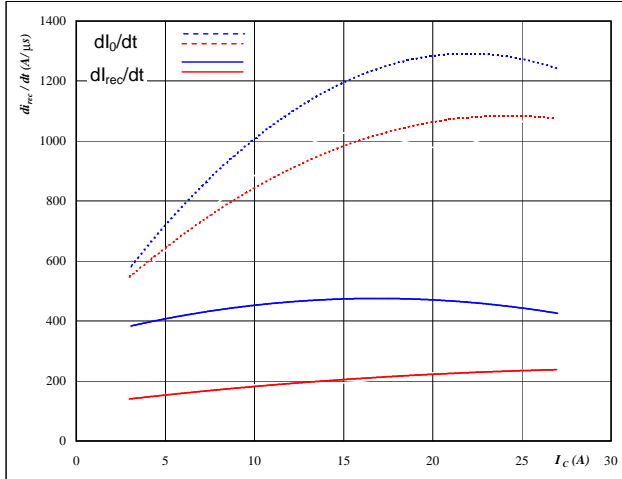

$T_j = 25/150 \text{ } ^\circ\text{C}$   
 $V_{CE} = 300 \text{ V}$   
 $V_{GE} = \pm 15 \text{ V}$   
 $R_{gon} = 32 \text{ } \Omega$

**figure 18** FWD

**Typical rate of fall of forward and reverse recovery current as a function of IGBT turn on gate resistor**

$$dI_0/dt, dI_{rec}/dt = f(R_{gon})$$

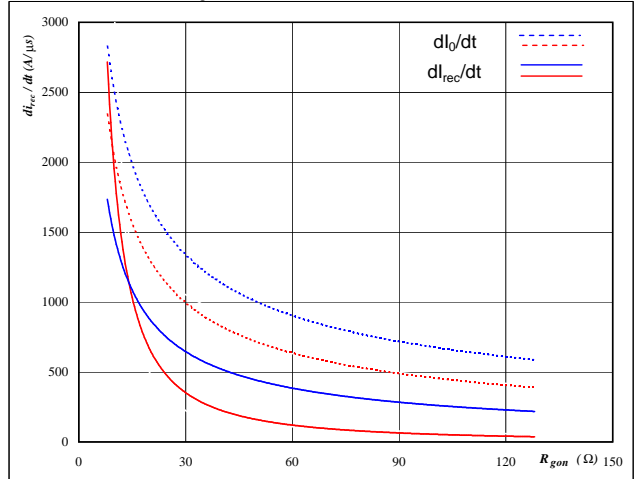

$T_j = 25/150 \text{ } ^\circ\text{C}$   
 $V_R = 300 \text{ V}$   
 $I_F = 15 \text{ A}$   
 $V_{GE} = \pm 15 \text{ V}$

**figure 19** IGBT

**IGBT transient thermal impedance as a function of pulse width**

$$Z_{th(j-s)} = f(t_p)$$

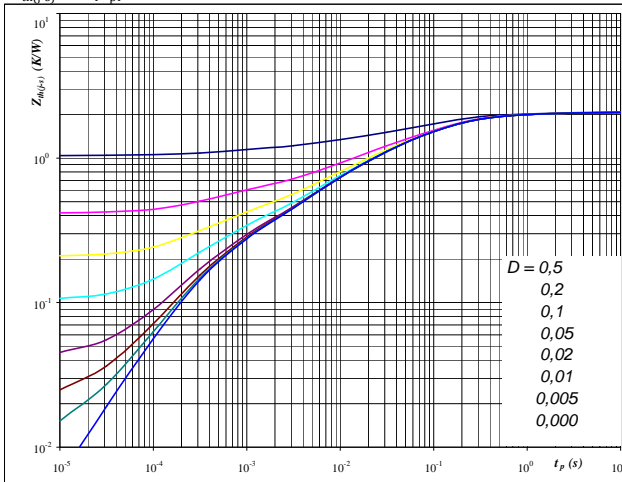

$D = t_p / T$   
 $R_{th(j-s)} = 2,08 \text{ K/W}$

IGBT thermal model values

R (K/W)	Tau (s)
3,85E-02	6,40E+00
1,88E-01	7,52E-01
8,37E-01	1,14E-01
5,51E-01	1,98E-02
2,73E-01	3,64E-03
1,88E-01	3,62E-04

**figure 20** FWD

**FWD transient thermal impedance as a function of pulse width**

$$Z_{th(j-s)} = f(t_p)$$

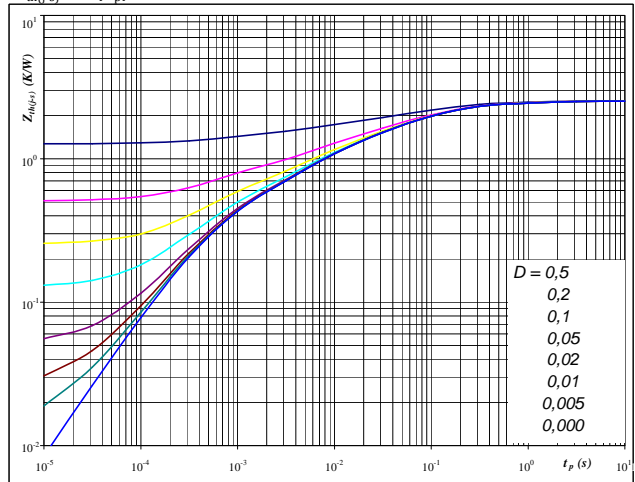

$D = t_p / T$   
 $R_{th(j-s)} = 2,54 \text{ K/W}$

FWD thermal model values

R (K/W)	Tau (s)
4,24E-02	7,07E+00
1,97E-01	7,40E-01
8,47E-01	1,09E-01
6,60E-01	2,11E-02
4,75E-01	3,82E-03
3,18E-01	4,62E-04





### Output Inverter

**figure 21** IGBT

Safe operating area as a function of collector-emitter voltage

$I_C = f(V_{CE})$

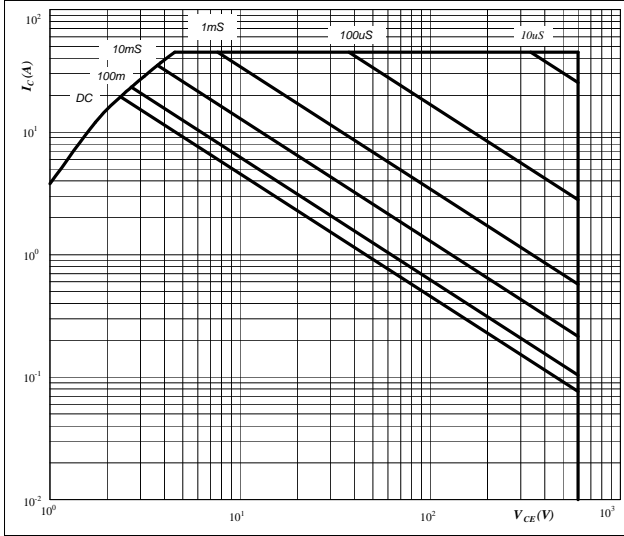

$D =$  single pulse  
 $T_h =$  80 °C  
 $V_{GE} =$  ±15 V  
 $T_j =$   $T_{jmax}$

**figure 22** IGBT

Gate voltage vs Gate charge

$V_{GE} = f(Q_g)$

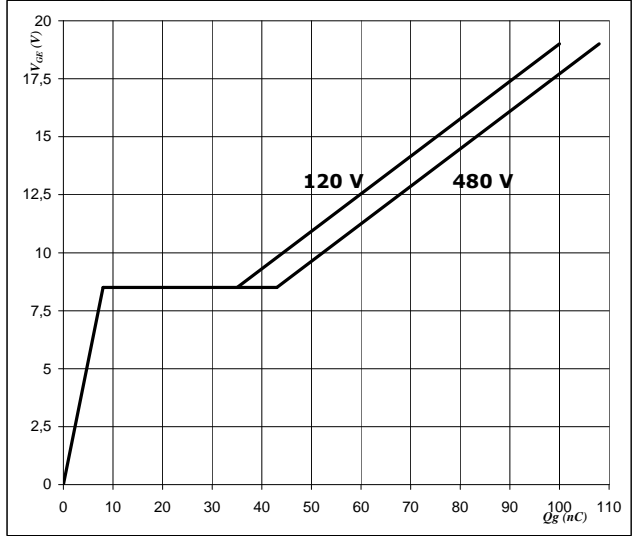

$I_C =$  15 A

### Thermistor

**figure 1** Thermistor

Typical NTC characteristic as a function of temperature

$R_T = f(T)$

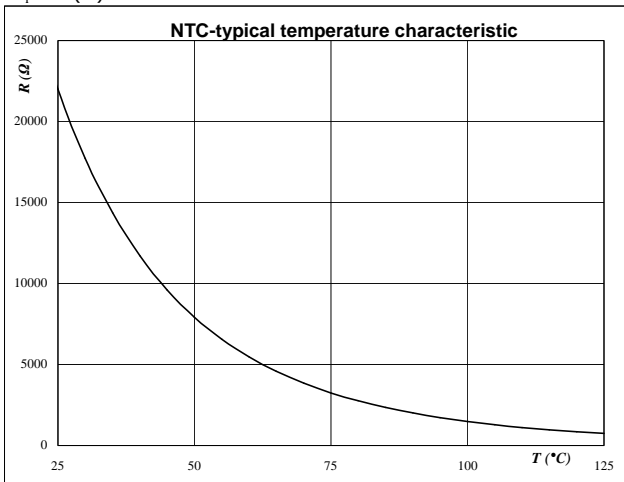



## Switching Definitions Output Inverter

### General conditions

$T_j$	=	150 °C
$R_{gon}$	=	32 $\Omega$
$R_{goff}$	=	32 $\Omega$

**Figure 1** IGBT

**Turn-off Switching Waveforms & definition of  $t_{doff}$   $t_{Eoff}$**   
( $t_{Eoff}$  = integrating time for  $E_{off}$ )

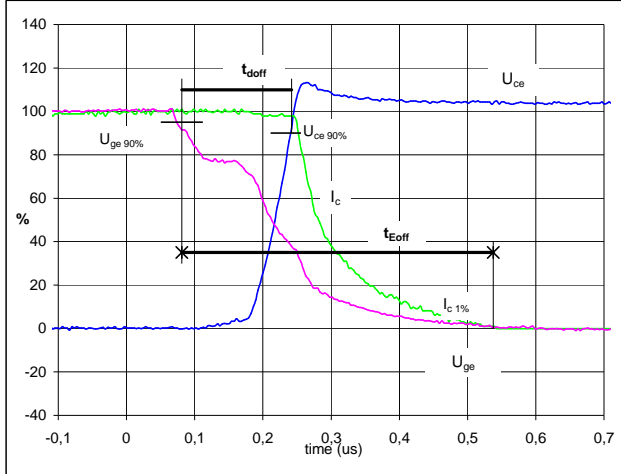

$V_{GE} (0\%) =$	-15	V
$V_{GE} (100\%) =$	15	V
$V_C (100\%) =$	300	V
$I_C (100\%) =$	15	A
$t_{doff} =$	0,16	$\mu$ s
$t_{Eoff} =$	0,46	$\mu$ s

**Figure 2** IGBT

**Turn-on Switching Waveforms & definition of  $t_{don}$   $t_{Eon}$**   
( $t_{Eon}$  = integrating time for  $E_{on}$ )

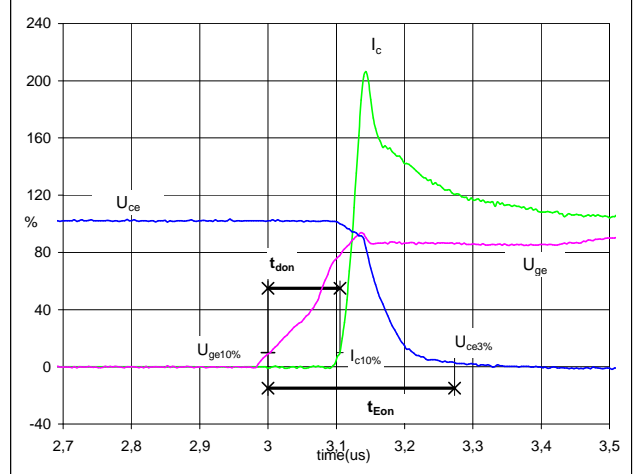

$V_{GE} (0\%) =$	-15	V
$V_{GE} (100\%) =$	15	V
$V_C (100\%) =$	300	V
$I_C (100\%) =$	15	A
$t_{don} =$	0,11	$\mu$ s
$t_{Eon} =$	0,27	$\mu$ s

**Figure 3** IGBT

**Turn-off Switching Waveforms & definition of  $t_f$**

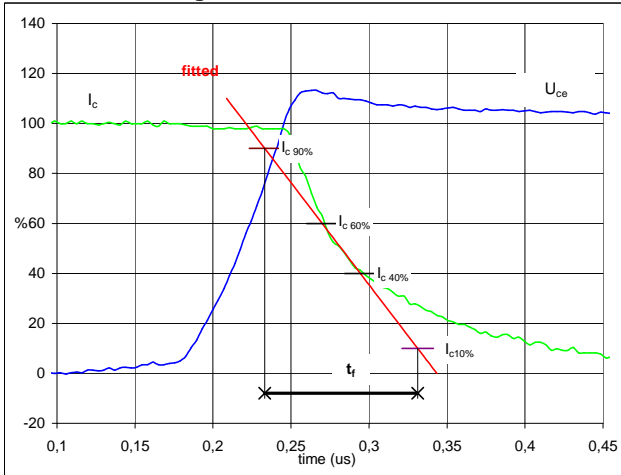

$V_C (100\%) =$	300	V
$I_C (100\%) =$	15	A
$t_f =$	0,11	$\mu$ s

**Figure 4** IGBT

**Turn-on Switching Waveforms & definition of  $t_r$**

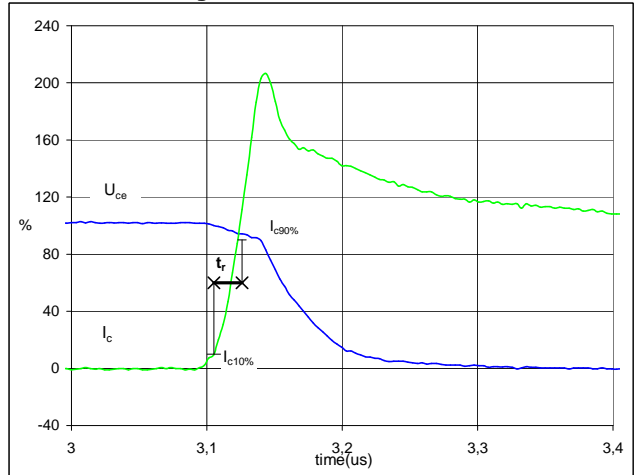

$V_C (100\%) =$	300	V
$I_C (100\%) =$	15	A
$t_r =$	0,02	$\mu$ s



## Switching Definitions Output Inverter

**Figure 5** IGBT  
**Turn-off Switching Waveforms & definition of  $t_{Eoff}$**

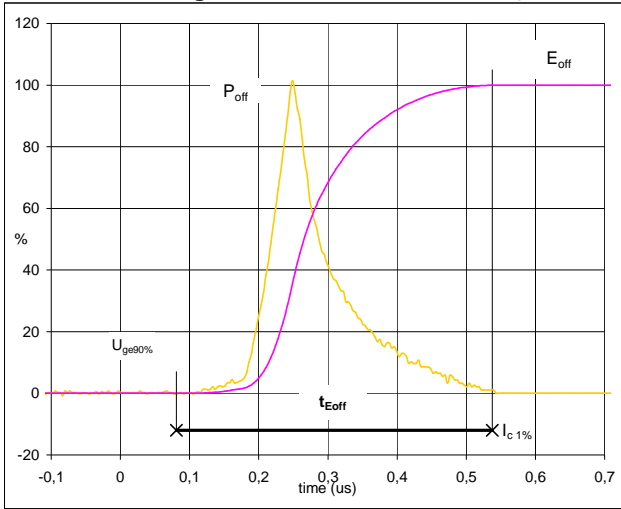

$P_{off} (100\%) = 4,50 \text{ kW}$   
 $E_{off} (100\%) = 0,46 \text{ mJ}$   
 $t_{Eoff} = 0,46 \text{ }\mu\text{s}$

**Figure 6** IGBT  
**Turn-on Switching Waveforms & definition of  $t_{Eon}$**

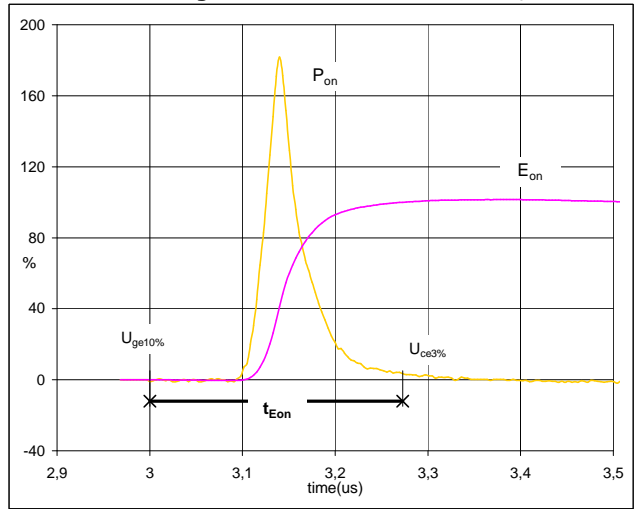

$P_{on} (100\%) = 4,50 \text{ kW}$   
 $E_{on} (100\%) = 0,38 \text{ mJ}$   
 $t_{Eon} = 0,27 \text{ }\mu\text{s}$

**Figure 7** FWD  
**Turn-off Switching Waveforms & definition of  $t_{rr}$**

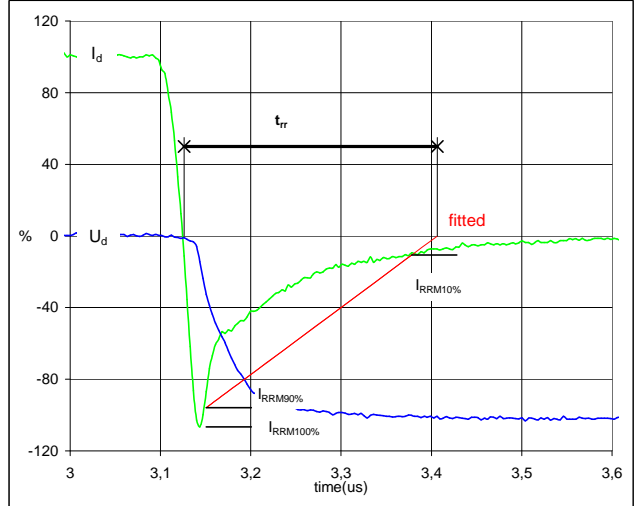

$V_d (100\%) = 300 \text{ V}$   
 $I_d (100\%) = 15 \text{ A}$   
 $I_{RRM} (100\%) = -16 \text{ A}$   
 $t_{rr} = 0,27 \text{ }\mu\text{s}$



## Switching Definitions Output Inverter

**Figure 8** FWD

Turn-on Switching Waveforms & definition of  $t_{Qrr}$   
 ( $t_{Qrr}$  = integrating time for  $Q_{rr}$ )

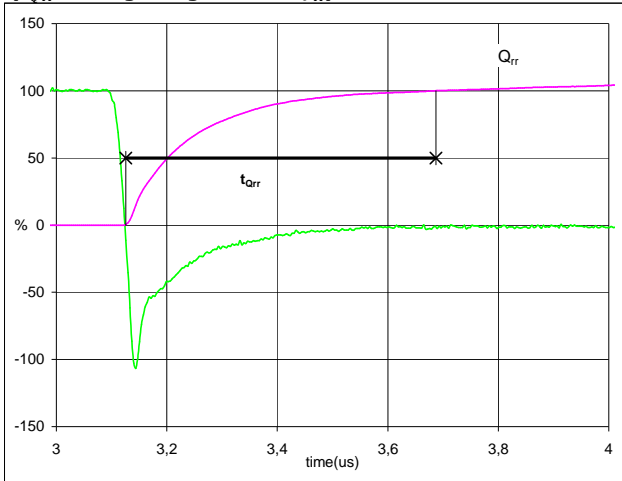

$I_d$ (100%) =	15	A
$Q_{rr}$ (100%) =	1,45	$\mu C$
$t_{Qrr}$ =	0,56	$\mu s$

**Figure 9** FWD

Turn-on Switching Waveforms & definition of  $t_{Erec}$   
 ( $t_{Erec}$  = integrating time for  $E_{rec}$ )

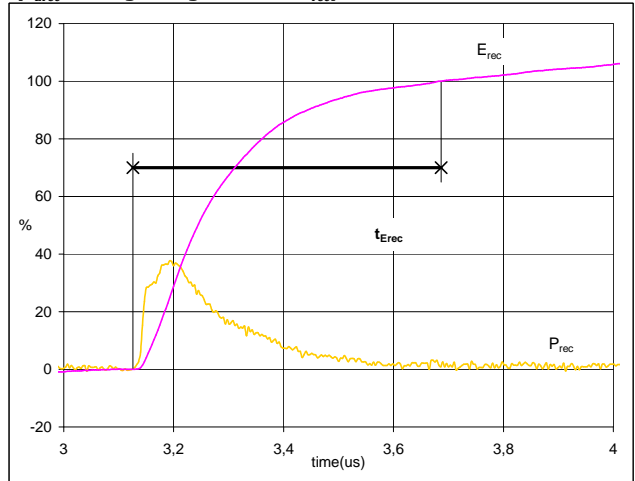

$P_{rec}$ (100%) =	4,50	kW
$E_{rec}$ (100%) =	0,31	mJ
$t_{Erec}$ =	0,56	$\mu s$



Ordering Code & Marking							
Version				Ordering Code			
without thermal paste 12 mm housing				V23990-P862-F48-PM			
without thermal paste 17 mm housing				V23990-P862-F48-PM			
	Text	VIN	Date code	Name&Ver	UL	Lot	Serial
		VIN	WWYY	NNNNVVV	UL	LLLLL	SSSS
	Datamatrix	Type&Ver	Lot number	Serial	Date code		
		TTTTTTVV	LLLLL	SSSS	WWYY		

Pin table [mm]				Outline	
Pin	X	Y	Function		
1	33,3	0	-Vcc		17 mm housing
2	30,7	0	S6		
3	27,9	0	G6		
4	23,85	0	S5		
5	21,05	0	G5		
6	15,95	0	NTC2		
7	9,6	0	NTC1		12 mm housing
8	5,4	0	G4		
9	2,6	0	S4		
10	0	0	-Vcc		
11	0	11,15	+Vcc		
12	0	22,3	U		
13	2,6	22,3	U		
14	5,5	22,3	G1		
15	13,1	22,3	G2		
16	15,9	22,3	V		
17	19,4	22,3	V		
18	27,7	22,3	G3		
19	30,7	22,3	W		
20	33,3	22,3	W		
21	33,3	11,15	+Vcc		

Tolerance of pinpositions: ±0.5mm at the end of pins  
Dimension of coordinate axis is only offset without tolerance

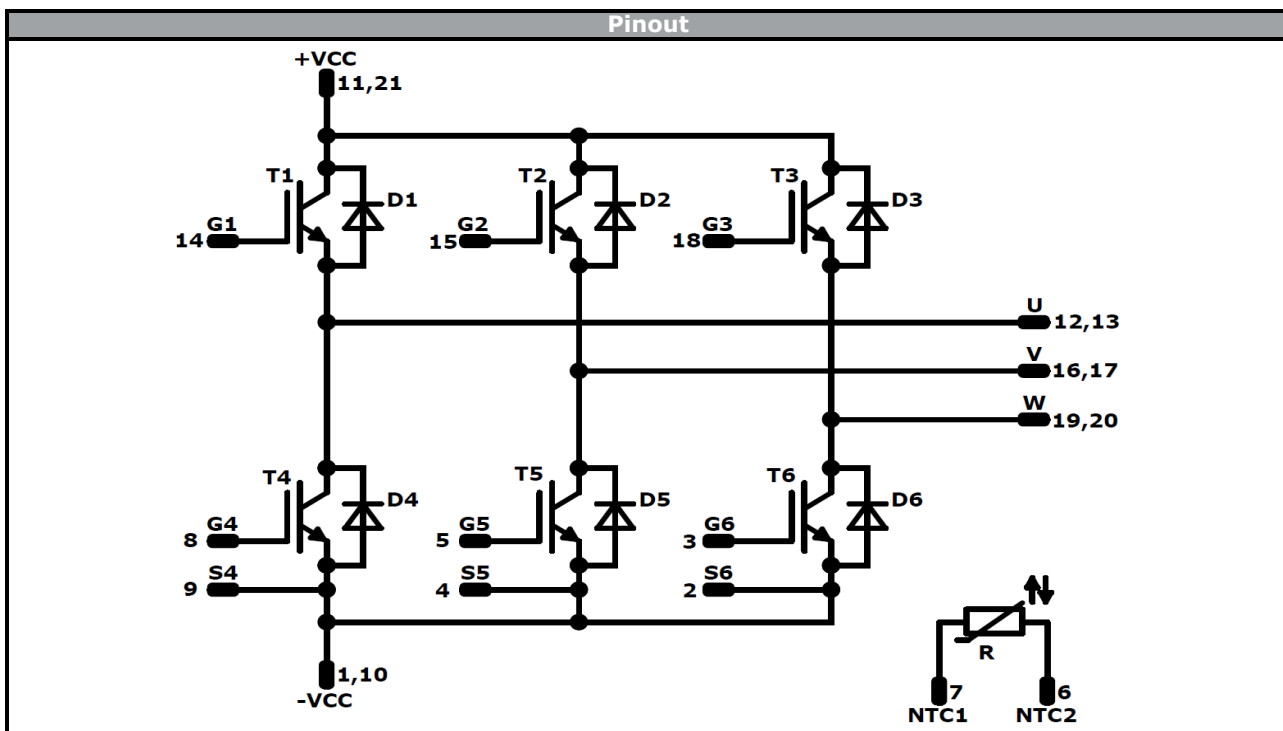

Identification					
ID	Component	Voltage	Current	Function	Comment
T1, T2, T3, T4, T5, T6	IGBT	600 V	15 A	Inverter Transistor	
D1, D2, D3, D4, D5, D6	FWD	600 V	15 A	Inverter Diode	
R	NTC			Thermistor	



Packaging instruction			
Standard packaging quantity (SPQ)	<b>135</b>	>SPQ Standard	<SPQ Sample

Handling instruction
Handling instructions for <i>flow</i> 0 packages see vincotech.com website.

Package data
Package data for <i>flow</i> 0 packages see vincotech.com website.

UL recognition and file number
This device is certified according to UL 1557 standard, UL file number E192116. For more information see vincotech.com website. 

Document No.:	Date:	Modification:	Pages
V23990-P862-F4x-D4-14	28 Jan. 2018		

**DISCLAIMER**

The information, specifications, procedures, methods and recommendations herein (together "information") are presented by Vincotech to reader in good faith, are believed to be accurate and reliable, but may well be incomplete and/or not applicable to all conditions or situations that may exist or occur. Vincotech reserves the right to make any changes without further notice to any products to improve reliability, function or design. No representation, guarantee or warranty is made to reader as to the accuracy, reliability or completeness of said information or that the application or use of any of the same will avoid hazards, accidents, losses, damages or injury of any kind to persons or property or that the same will not infringe third parties rights or give desired results. It is reader's sole responsibility to test and determine the suitability of the information and the product for reader's intended use.

**LIFE SUPPORT POLICY**

Vincotech products are not authorised for use as critical components in life support devices or systems without the express written approval of Vincotech.

As used herein:

1. Life support devices or systems are devices or systems which, (a) are intended for surgical implant into the body, or (b) support or sustain life, or (c) whose failure to perform when properly used in accordance with instructions for use provided in labelling can be reasonably expected to result in significant injury to the user.
2. A critical component is any component of a life support device or system whose failure to perform can be reasonably expected to cause the failure of the life support device or system, or to affect its safety or effectiveness.