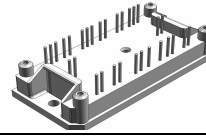

*flow*PACK 1 3rd gen

1200 V / 35 A

Features

- Compact *flow*1 housing
- Trench Fieldstop IGBT4 Technology
- Compact and Low Inductance Design
- Built-in NTC

flow1 housing

Target Applications

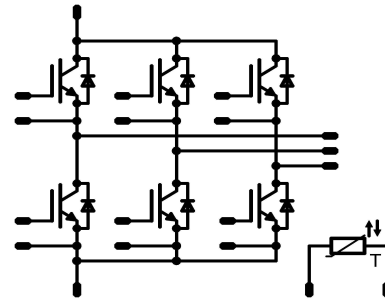
- Motor Drive
- Power Generation
- UPS

Schematic

Types

- V23990-P828-F10-PM

Maximum Ratings

 $T_j=25^\circ\text{C}$, unless otherwise specified

Parameter	Symbol	Condition	Value	Unit
Inverter Transistor				
Collector-emitter break down voltage	V_{CE}		1200	V
DC collector current	I_C	$T_j=T_{j,max}$ $T_h=80^\circ\text{C}$ $T_c=80^\circ\text{C}$	33	A
Repetitive peak collector current	$I_{C,pulse}$	t_p limited by $T_{j,max}$ $T_h=80^\circ\text{C}$ $T_c=80^\circ\text{C}$	105	A
Power dissipation	P_{tot}	$T_j=T_{j,max}$ $T_h=80^\circ\text{C}$ $T_c=80^\circ\text{C}$	81	W
Gate-emitter peak voltage	V_{GE}		± 20	V
Short circuit ratings	t_{SC} V_{CC}	$T_j \leq 150^\circ\text{C}$ $V_{GE}=15\text{V}$	10 800	μs V
Maximum Junction Temperature	$T_{j,max}$		175	$^\circ\text{C}$
Inverter Diode				
Peak Repetitive Reverse Voltage	V_{RRM}	$T_j=25^\circ\text{C}$	1200	V
DC forward current	I_F	$T_j=T_{j,max}$ $T_h=80^\circ\text{C}$ $T_c=80^\circ\text{C}$	35	A
Repetitive peak forward current	I_{FRM}	t_p limited by $T_{j,max}$ $T_h=80^\circ\text{C}$ $T_c=80^\circ\text{C}$	70	A
Power dissipation	P_{tot}	$T_j=T_{j,max}$ $T_h=80^\circ\text{C}$ $T_c=80^\circ\text{C}$	63	W
Maximum Junction Temperature	$T_{j,max}$		175	$^\circ\text{C}$
Thermal Properties				
Storage temperature	T_{stg}		-40...+125	$^\circ\text{C}$
Operation temperature under switching condition	T_{op}		-40...+150	$^\circ\text{C}$

Maximum Ratings

T_j=25°C, unless otherwise specified

Parameter	Symbol	Condition	Value	Unit
-----------	--------	-----------	-------	------

Insulation Properties

Insulation voltage	V _{is}	t=1min	4000	V _{DC}
Creepage distance			min 12,7	mm
Clearance			min 12,7	mm

Characteristic Values

Parameter	Symbol	Conditions					Value			Unit
		$V_{GE}[V]$ or $V_{GS}[V]$	$V_r[V]$ or $V_{CE}[V]$ or $V_{DS}[V]$	$I_c[A]$ or $I_F[A]$ or $I_D[A]$	T_j	Min	Typ	Max		
Inverter Transistor										
Gate emitter threshold voltage	$V_{GE(th)}$	VCE=VGE			0,0012	T _J =25°C T _J =150°C	5	5,8	6,5	V
Collector-emitter saturation voltage	$V_{CE(sat)}$		15		35	T _J =25°C T _J =150°C	1,3	1,92 2,39	2,3	V
Collector-emitter cut-off current incl. Diode	I_{CES}		0	1200		T _J =25°C T _J =150°C			0,015	mA
Gate-emitter leakage current	I_{GES}		20	0		T _J =25°C T _J =150°C			200	nA
Integrated Gate resistor	R_{gint}							none		Ω
Turn-on delay time	$t_{d(on)}$	R _{goff} =16 Ω R _{gon} =16 Ω	±15	600	35	T _J =25°C		91		ns
Rise time	t_r					T _J =150°C		94		
Turn-off delay time	$t_{d(off)}$					T _J =25°C		19		
Fall time	t_f					T _J =150°C		23		
Turn-on energy loss per pulse	E_{on}					T _J =25°C		204		
Turn-off energy loss per pulse	E_{off}					T _J =150°C		264		
Input capacitance	C_{iss}									
Output capacitance	C_{oss}	f=1MHz	0	25		T _J =25°C		155		
Reverse transfer capacitance	C_{iss}					T _J =25°C		115		
Gate charge	Q_{Gate}	V _{CC} =960V	±15		35	T _J =25°C		180		nC
Thermal resistance chip to heatsink	R_{thJH}	Thermal grease thickness≤50um λ = 1 W/mK						1,18		K/W
Inverter Diode										
Diode forward voltage	V_F				35	T _J =25°C T _J =150°C	1,35	1,80 1,77	2,35	V
Peak reverse recovery current	I_{RRM}	R _{gon} =16 Ω	±15	600	35	T _J =25°C		48		A
Reverse recovery time	t_{rr}					T _J =150°C		53		
Reverse recovered charge	Q_{rr}					T _J =25°C		251		
Peak rate of fall of recovery current	$di(rec)max/dt$					T _J =150°C		353		
Reverse recovered energy	E_{rec}					T _J =25°C		3,56		
						T _J =150°C		6,93		
Thermal resistance chip to heatsink	R_{thJH}	Thermal grease thickness≤50um λ = 1 W/mK						1,38 2,83		K/W
Thermistor										
Rated resistance	R					T _J =25°C		4,7		kΩ
Deviation of R100	ΔR/R	R100=401 Ω				T _J =100°C	-12,4		12,4	%
Power dissipation	P					T _J =25°C		210		mW
Power dissipation constant						T _J =25°C		3,5		mW/K
B-value	B(25/50)					T _J =25°C		3590		K
B-value	B(25/100)					T _J =25°C		3650		K
Vincotech NTC Reference									D	

Output Inverter

Figure 1 Output inverter IGBT

Typical output characteristics

$$I_C = f(V_{CE})$$

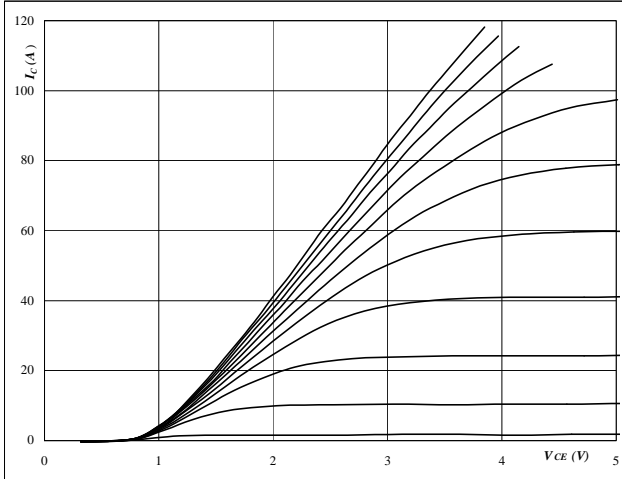
At

$$t_p = 250 \mu s$$

$$T_J = 25 \text{ } ^\circ C$$

 V_{GE} from 7 V to 17 V in steps of 1 V

Figure 2 Output inverter IGBT

Typical output characteristics

$$I_C = f(V_{CE})$$

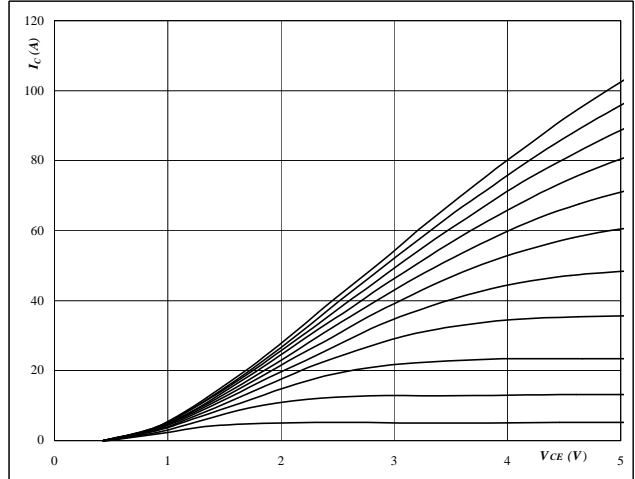
At

$$t_p = 250 \mu s$$

$$T_J = 150 \text{ } ^\circ C$$

 V_{GE} from 7 V to 17 V in steps of 1 V

Figure 3 Output inverter IGBT

Typical transfer characteristics

$$I_C = f(V_{GE})$$

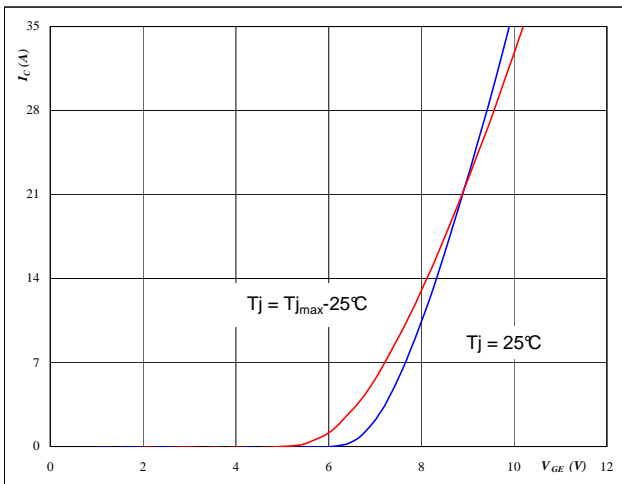
At

$$t_p = 250 \mu s$$

$$V_{CE} = 10 \text{ V}$$

Figure 4 Output inverter FWD

Typical diode forward current as a function of forward voltage

$$I_F = f(V_F)$$

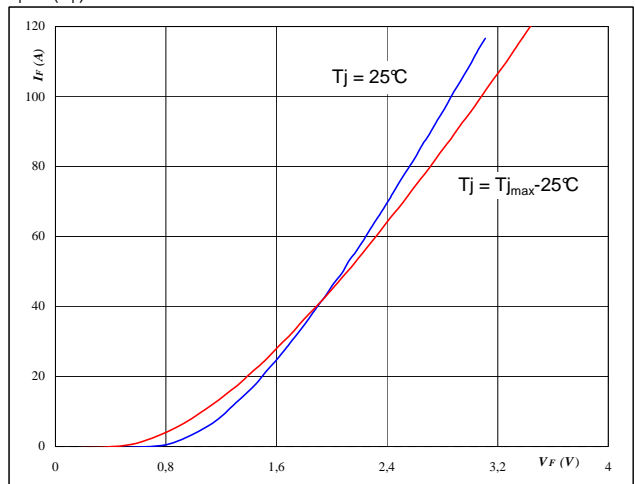
At

$$t_p = 250 \mu s$$

Output Inverter

Figure 5 Output inverter IGBT

Typical switching energy losses
 as a function of collector current

$$E = f(I_c)$$

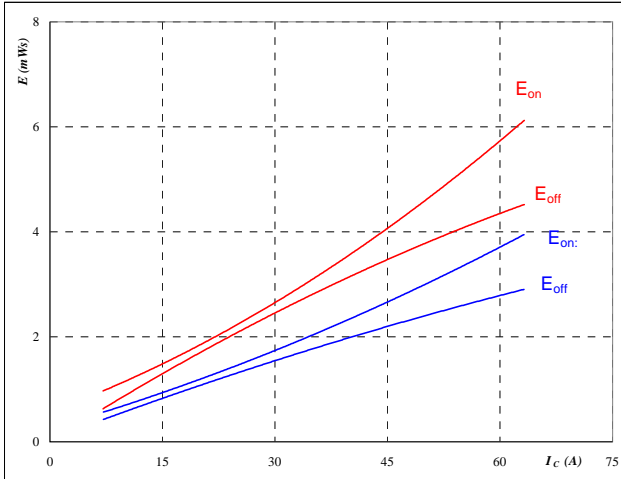

With an inductive load at

$T_j =$	25/150	°C
$V_{CE} =$	600	V
$V_{GE} =$	±15	V
$R_{gon} =$	16	Ω
$R_{goff} =$	16	Ω

Figure 6 Output inverter IGBT

Typical switching energy losses
 as a function of gate resistor

$$E = f(R_G)$$

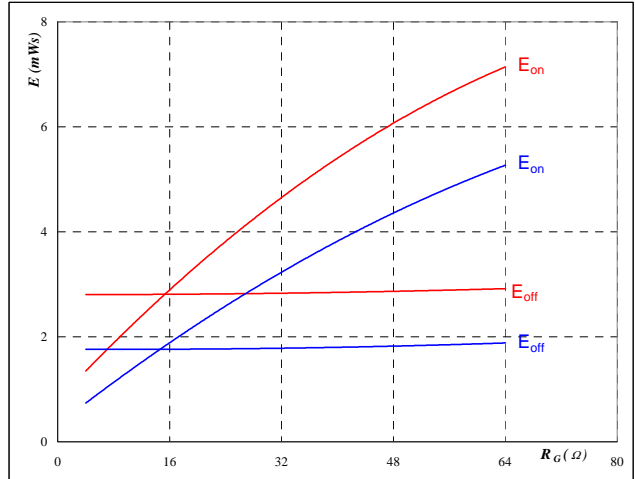

With an inductive load at

$T_j =$	25/150	°C
$V_{CE} =$	600	V
$V_{GE} =$	±15	V
$I_c =$	35	A

Figure 7 Output inverter IGBT

Typical reverse recovery energy loss
 as a function of collector current

$$E_{rec} = f(I_c)$$

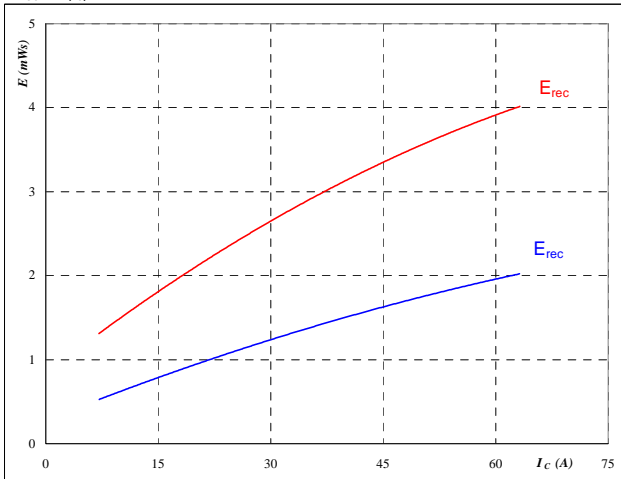

With an inductive load at

$T_j =$	25/150	°C
$V_{CE} =$	600	V
$V_{GE} =$	±15	V
$R_{gon} =$	16	Ω

Figure 8 Output inverter IGBT

Typical reverse recovery energy loss
 as a function of gate resistor

$$E_{rec} = f(R_G)$$

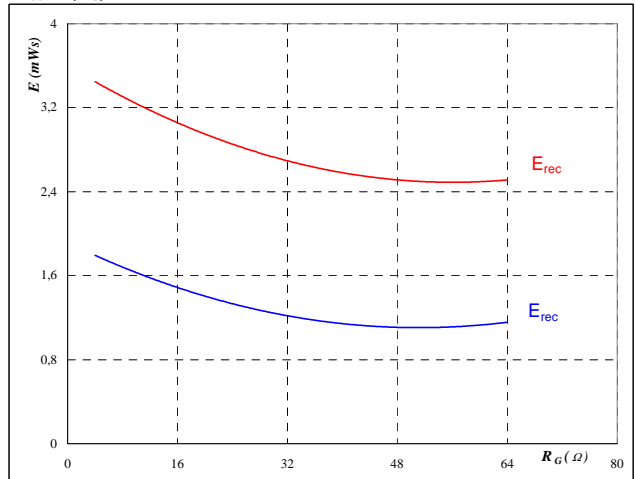

With an inductive load at

$T_j =$	25/150	°C
$V_{CE} =$	600	V
$V_{GE} =$	±15	V
$I_c =$	35	A

Output Inverter

Figure 9 Output inverter IGBT

Typical switching times as a function of collector current

$$t = f(I_C)$$

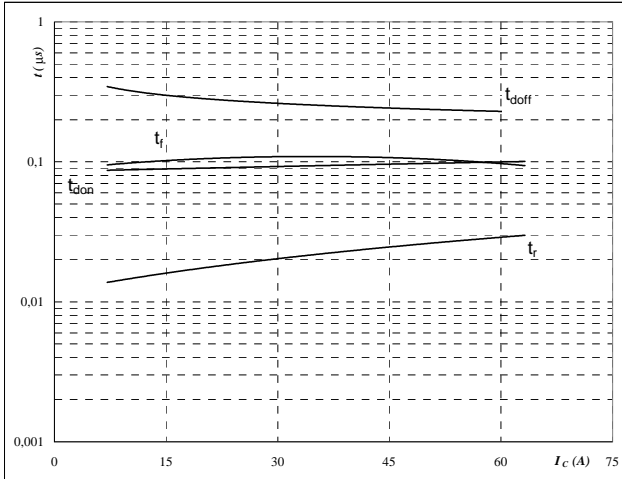

With an inductive load at

$T_J =$	150	$^{\circ}C$
$V_{CE} =$	600	V
$V_{GE} =$	± 15	V
$R_{gon} =$	16	Ω
$R_{goff} =$	16	Ω

Figure 10 Output inverter IGBT

Typical switching times as a function of gate resistor

$$t = f(R_G)$$

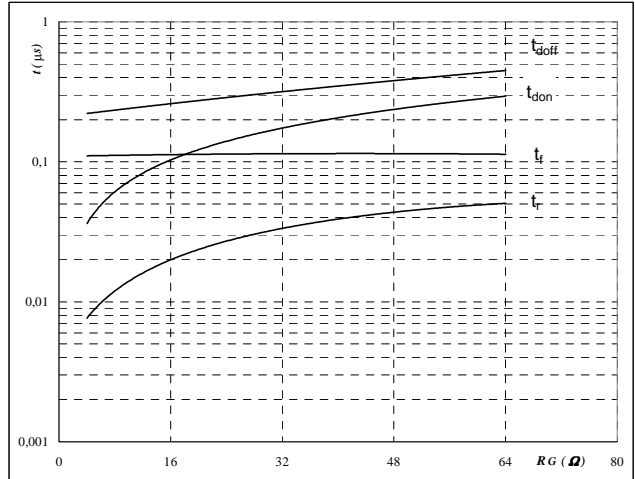

With an inductive load at

$T_J =$	150	$^{\circ}C$
$V_{CE} =$	600	V
$V_{GE} =$	± 15	V
$I_C =$	35	A

Figure 11 Output inverter FWD

Typical reverse recovery time as a function of collector current

$$t_{rr} = f(I_C)$$

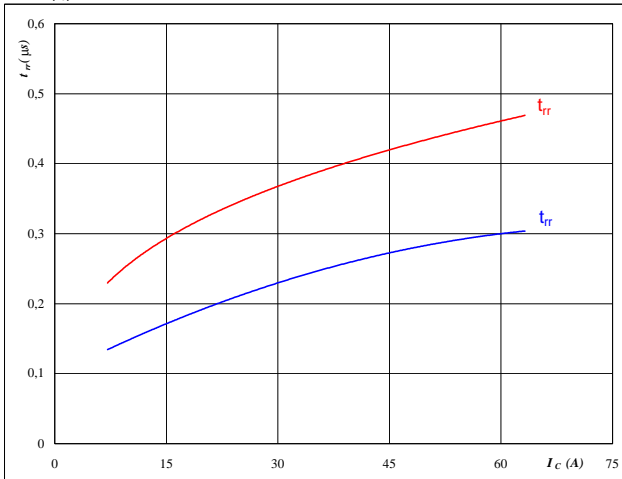

At

$T_J =$	25/150	$^{\circ}C$
$V_{CE} =$	600	V
$V_{GE} =$	± 15	V
$R_{gon} =$	16	Ω

Figure 12 Output inverter FWD

Typical reverse recovery time as a function of IGBT turn on gate resistor

$$t_{rr} = f(R_{gon})$$

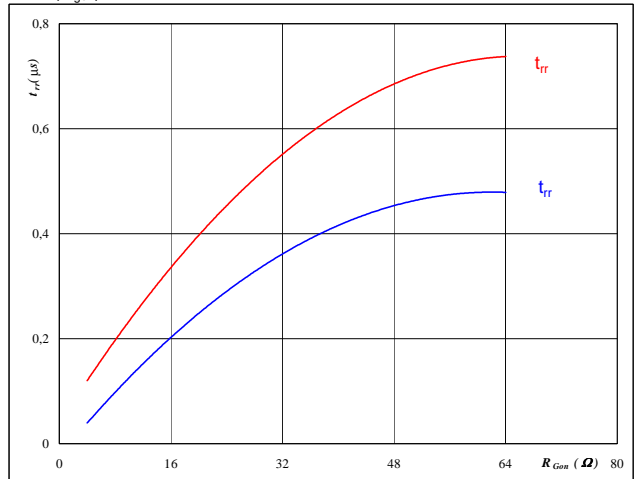

At

$T_J =$	25/150	$^{\circ}C$
$V_R =$	600	V
$I_F =$	35	A
$V_{GE} =$	± 15	V

Output Inverter

Figure 13 Output inverter FWD

Typical reverse recovery charge as a function of collector current

$$Q_{rr} = f(I_c)$$

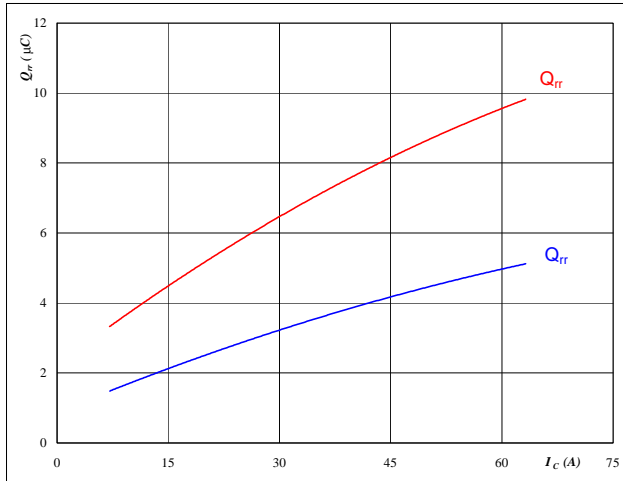

At
 $T_j = 25/150$ °C
 $V_{CE} = 600$ V
 $V_{GE} = \pm 15$ V
 $R_{gon} = 16$ Ω

Figure 14 Output inverter FWD

Typical reverse recovery charge as a function of IGBT turn on gate resistor

$$Q_{rr} = f(R_{gon})$$

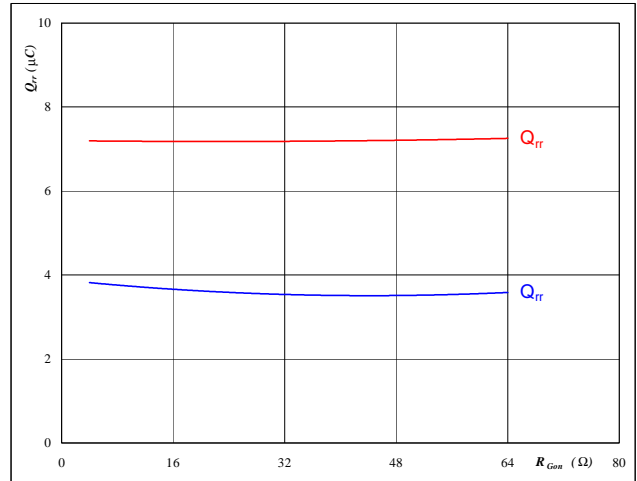

At
 $T_j = 25/150$ °C
 $V_R = 600$ V
 $I_F = 35$ A
 $V_{GE} = \pm 15$ V

Figure 15 Output inverter FWD

Typical reverse recovery current as a function of collector current

$$I_{RRM} = f(I_c)$$

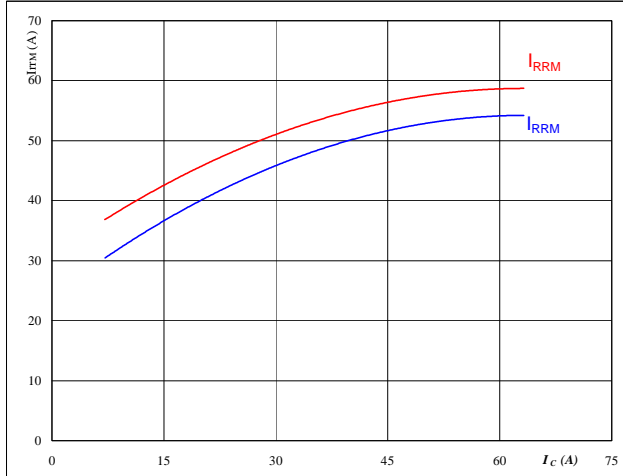

At
 $T_j = 25/150$ °C
 $V_{CE} = 600$ V
 $V_{GE} = \pm 15$ V
 $R_{gon} = 16$ Ω

Figure 16 Output inverter FWD

Typical reverse recovery current as a function of IGBT turn on gate resistor

$$I_{RRM} = f(R_{gon})$$

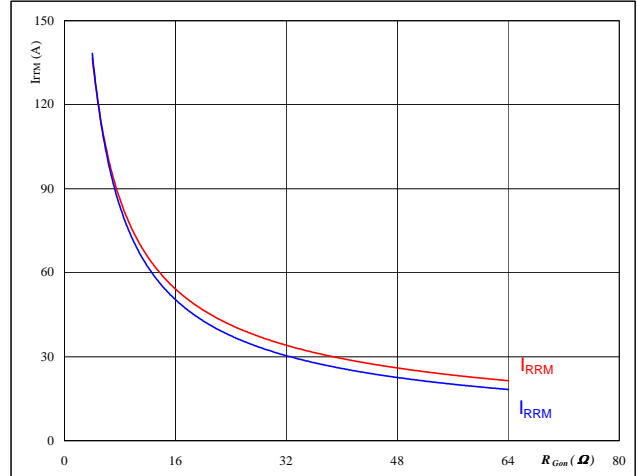

At
 $T_j = 25/150$ °C
 $V_R = 600$ V
 $I_F = 35$ A
 $V_{GE} = \pm 15$ V

Output Inverter

Figure 17 Output inverter FWD

Typical rate of fall of forward and reverse recovery current as a function of collector current

$$di_o/dt, di_{rec}/dt = f(I_c)$$

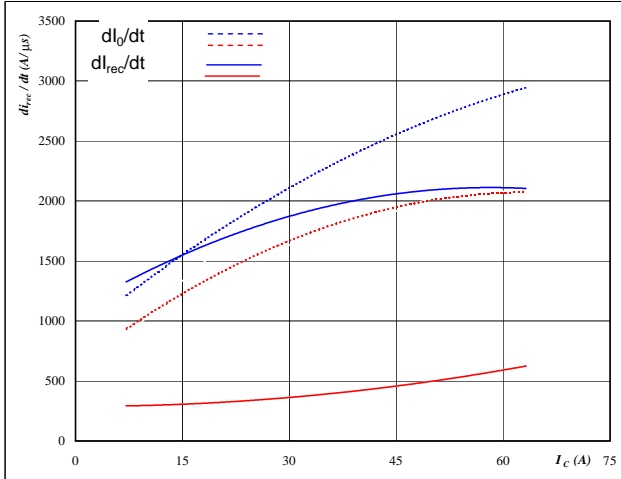

At
 $T_j = 25/150$ °C
 $V_{CE} = 600$ V
 $V_{GE} = \pm 15$ V
 $R_{gon} = 16$ Ω

Figure 18 Output inverter FWD

Typical rate of fall of forward and reverse recovery current as a function of IGBT turn on gate resistor

$$di_o/dt, di_{rec}/dt = f(R_{gon})$$

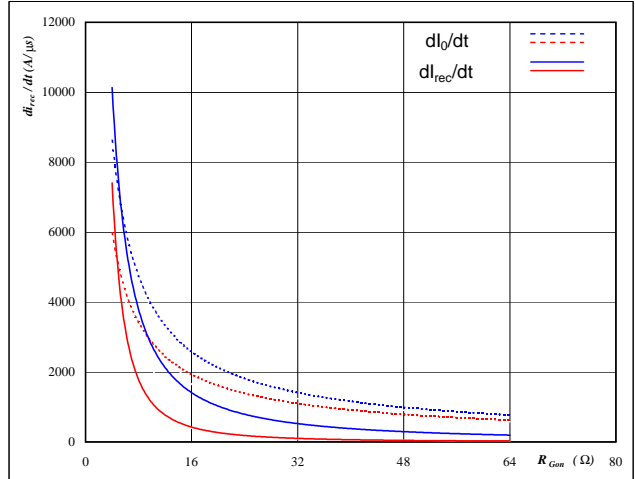

At
 $T_j = 25/150$ °C
 $V_R = 600$ V
 $I_F = 35$ A
 $V_{GE} = \pm 15$ V

Figure 19 Output inverter IGBT

IGBT transient thermal impedance as a function of pulse width

$$Z_{thJH} = f(tp)$$

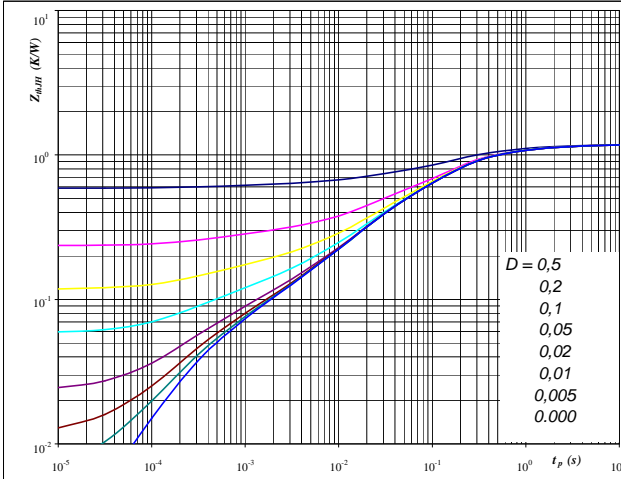

At
 $D = tp / T$
 $R_{thJH} = 1,18$ K/W

IGBT thermal model values

R (K/W)	Tau (s)
0,07	3,9E+00
0,25	5,9E-01
0,56	1,3E-01
0,21	1,8E-02
0,05	2,0E-03
0,04	3,1E-04

Figure 20 Output inverter FWD

FWD transient thermal impedance as a function of pulse width

$$Z_{thJH} = f(tp)$$

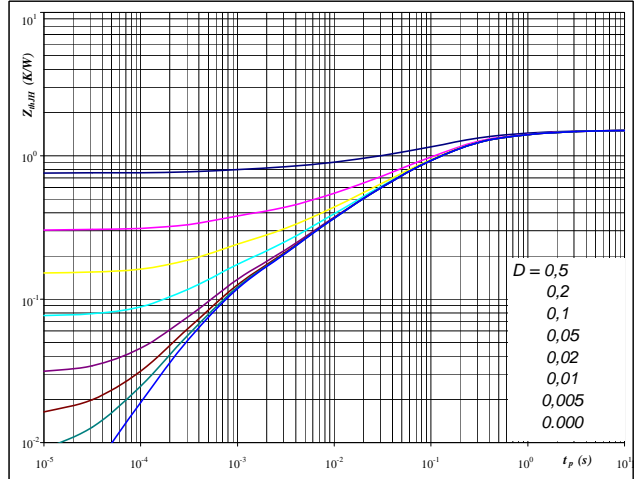

At
 $D = tp / T$
 $R_{thJH} = 1,52$ K/W

FWD thermal model values

R (K/W)	Tau (s)
0,05	9,6E+00
0,19	1,0E+00
0,67	1,6E-01
0,34	3,4E-02
0,18	6,6E-03
0,10	6,1E-04

Output Inverter

Figure 21 Output inverter IGBT

Power dissipation as a function of heatsink temperature

$$P_{tot} = f(T_h)$$



At
 $T_j = 175$ °C

Figure 22 Output inverter IGBT

Collector current as a function of heatsink temperature

$$I_C = f(T_h)$$

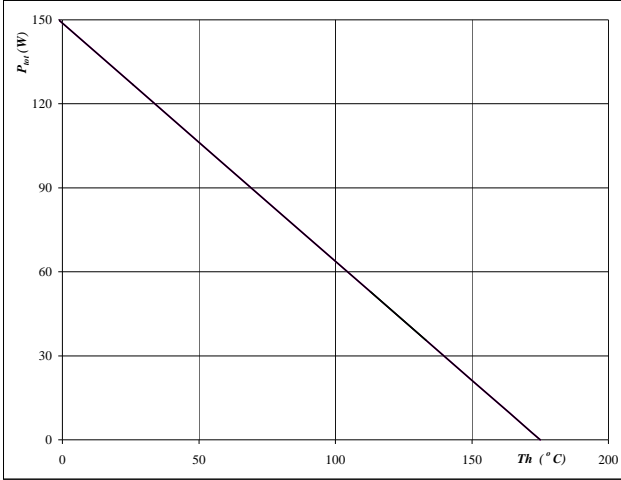

At
 $T_j = 175$ °C
 $V_{GE} = 15$ V

Figure 23 Output inverter FWD

Power dissipation as a function of heatsink temperature

$$P_{tot} = f(T_h)$$

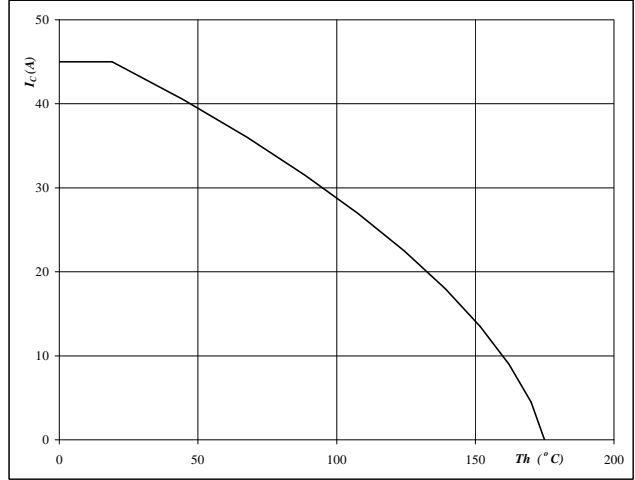

At
 $T_j = 175$ °C

Figure 24 Output inverter FWD

Forward current as a function of heatsink temperature

$$I_F = f(T_h)$$

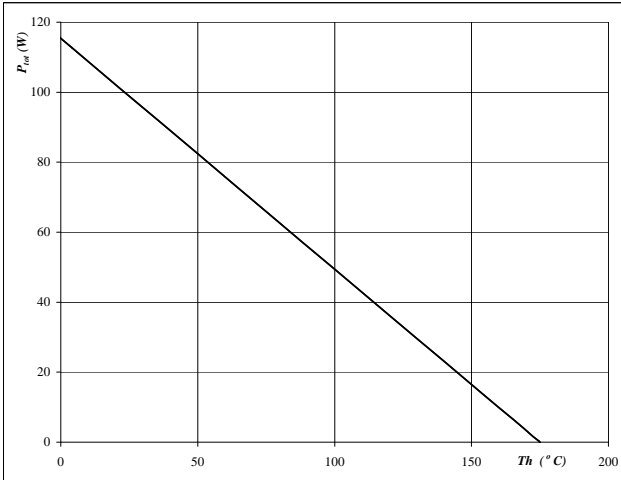
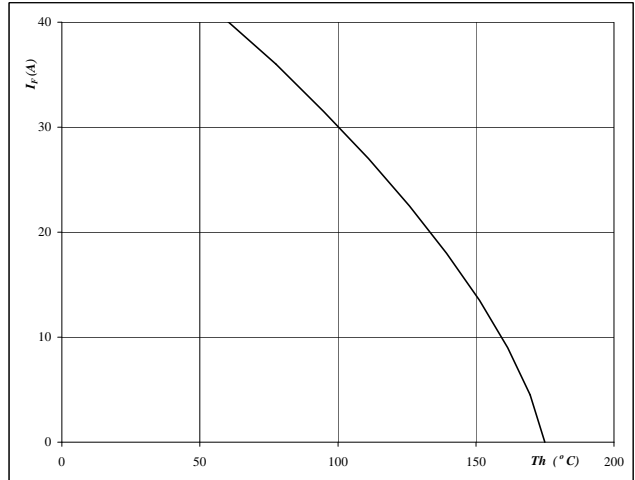

At
 $T_j = 175$ °C

Output Inverter

Figure 25 Output inverter IGBT

Safe operating area as a function of collector-emitter voltage

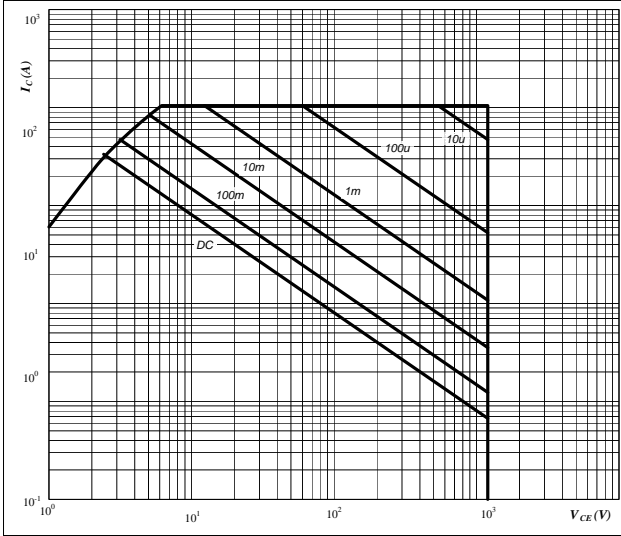
$$I_C = f(V_{CE})$$



At
 D = single pulse
 Th = 80 °C
 V_{GE} = ±15 V
 T_j = T_{jmax} °C

Figure 26 Output inverter IGBT

Gate voltage vs Gate charge

$$V_{GE} = f(Q_g)$$

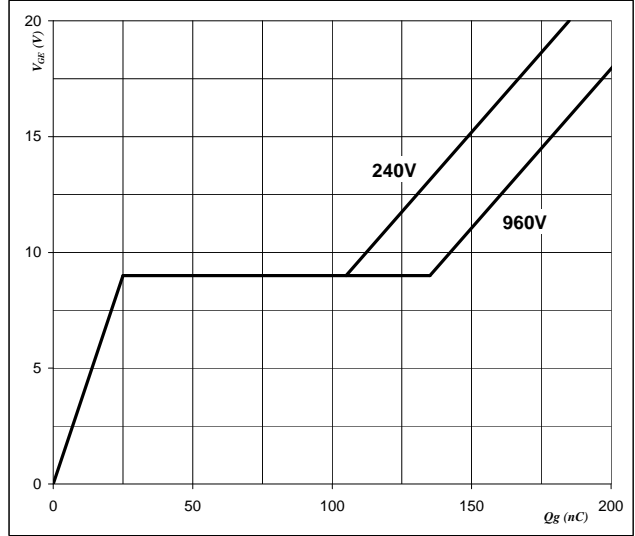

At
 I_C = 35 A

Thermistor

Figure 1 Thermistor

Typical NTC characteristic
as a function of temperature

$$R_T = f(T)$$

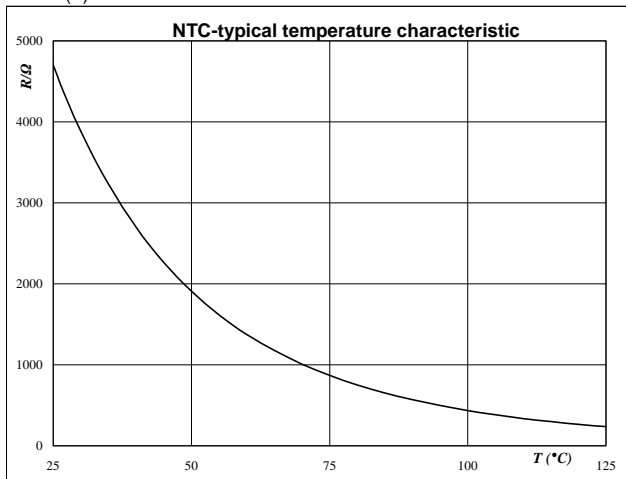

Switching Definitions Output Inverter

General conditions	
T_j	= 150 °C
R_{gon}	= 16 Ω
R_{goff}	= 16 Ω

Figure 1 Output inverter IGBT

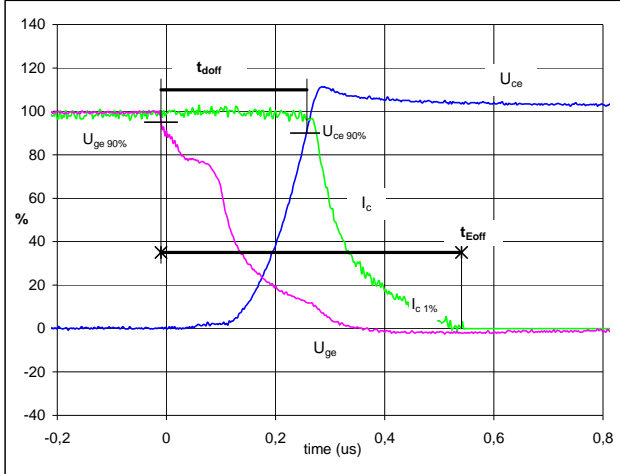
Turn-off Switching Waveforms & definition of t_{doff} , t_{Eoff}
 (t_{Eoff} = integrating time for E_{off})

$V_{GE}(0\%) =$	-15	V
$V_{GE}(100\%) =$	15	V
$V_C(100\%) =$	600	V
$I_C(100\%) =$	35	A
$t_{doff} =$	0,26	μs
$t_{Eoff} =$	0,55	μs

Figure 2 Output inverter IGBT

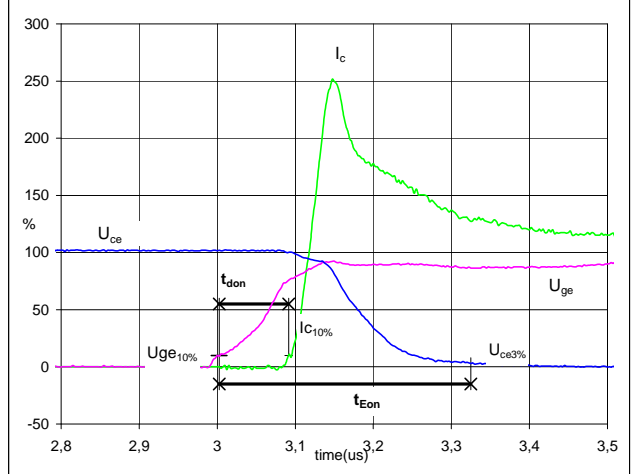
Turn-on Switching Waveforms & definition of t_{don} , t_{Eon}
 (t_{Eon} = integrating time for E_{on})

$V_{GE}(0\%) =$	-15	V
$V_{GE}(100\%) =$	15	V
$V_C(100\%) =$	600	V
$I_C(100\%) =$	35	A
$t_{don} =$	0,09	μs
$t_{Eon} =$	0,32	μs

Figure 3 Output inverter IGBT

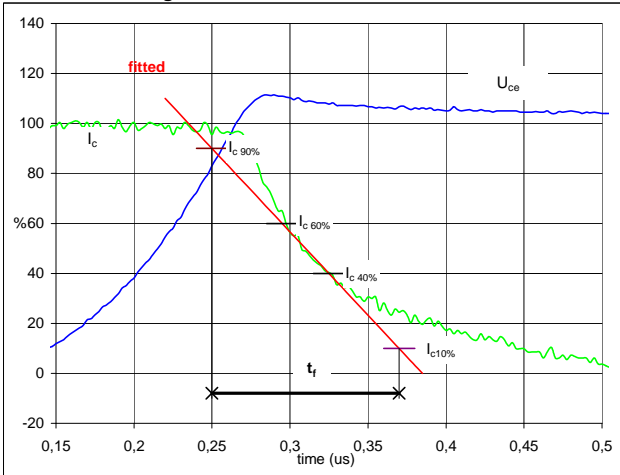
Turn-off Switching Waveforms & definition of t_f

$V_C(100\%) =$	600	V
$I_C(100\%) =$	35	A
$t_f =$	0,11	μs

Figure 4 Output inverter IGBT

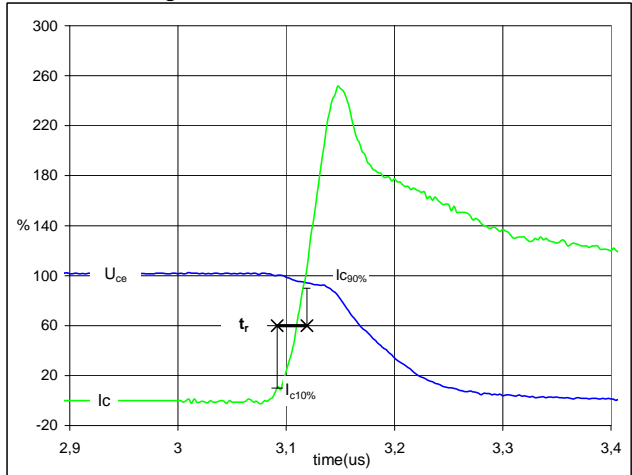
Turn-on Switching Waveforms & definition of t_r

$V_C(100\%) =$	600	V
$I_C(100\%) =$	35	A
$t_r =$	0,02	μs

Switching Definitions Output Inverter

Figure 5 Output inverter IGBT

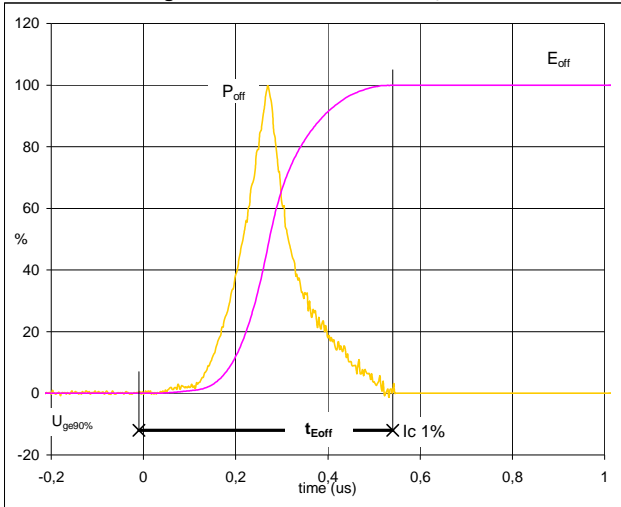
Turn-off Switching Waveforms & definition of t_{Eoff}

$P_{off} (100\%) = 20,98 \text{ kW}$
 $E_{off} (100\%) = 2,81 \text{ mJ}$
 $t_{Eoff} = 0,55 \text{ } \mu\text{s}$

Figure 6 Output inverter IGBT

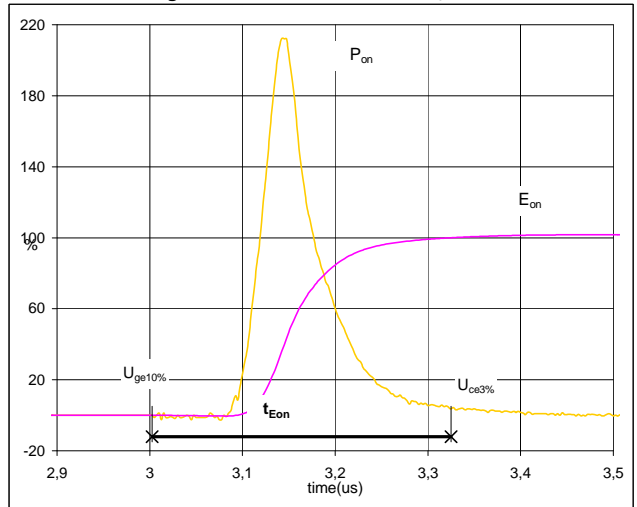
Turn-on Switching Waveforms & definition of t_{Eon}

$P_{on} (100\%) = 20,98 \text{ kW}$
 $E_{on} (100\%) = 3,09 \text{ mJ}$
 $t_{Eon} = 0,32 \text{ } \mu\text{s}$

Figure 7 Output inverter FWD

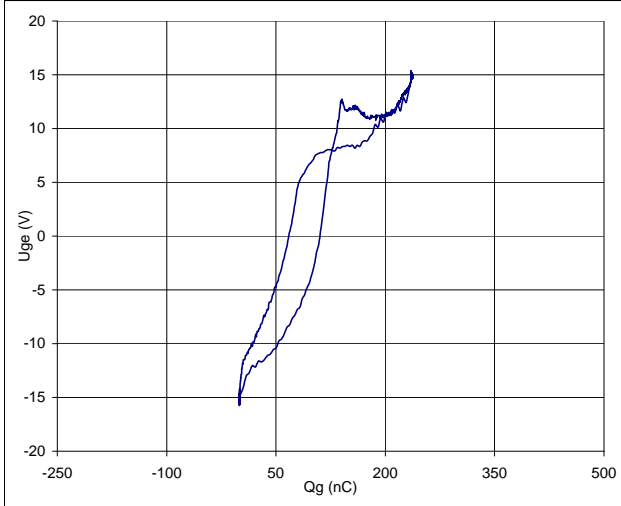
Gate voltage vs Gate charge (measured)

$V_{GEoff} = -15 \text{ V}$
 $V_{GEon} = 15 \text{ V}$
 $V_C (100\%) = 600 \text{ V}$
 $I_C (100\%) = 35 \text{ A}$
 $Q_g = 236,86 \text{ nC}$

Figure 8 Output inverter IGBT

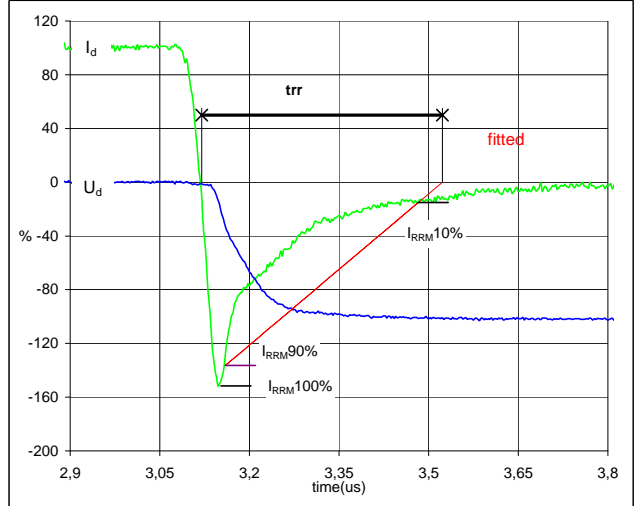
Turn-off Switching Waveforms & definition of t_{rr}

$V_d (100\%) = 600 \text{ V}$
 $I_d (100\%) = 35 \text{ A}$
 $I_{RRM} (100\%) = -53 \text{ A}$
 $t_{rr} = 0,35 \text{ } \mu\text{s}$

Switching Definitions Output Inverter

Figure 9 Output inverter FWD

Turn-on Switching Waveforms & definition of t_{Qrr}
 (t_{Qrr} = integrating time for Q_{rr})

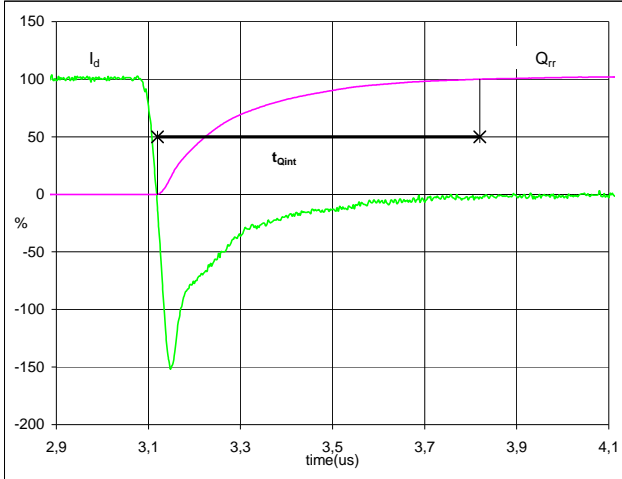

I_d (100%) =	35	A
Q_{rr} (100%) =	6,93	μC
t_{Qint} =	0,70	μs

Figure 10 Output inverter FWD

Turn-on Switching Waveforms & definition of t_{Erec}
 (t_{Erec} = integrating time for E_{rec})

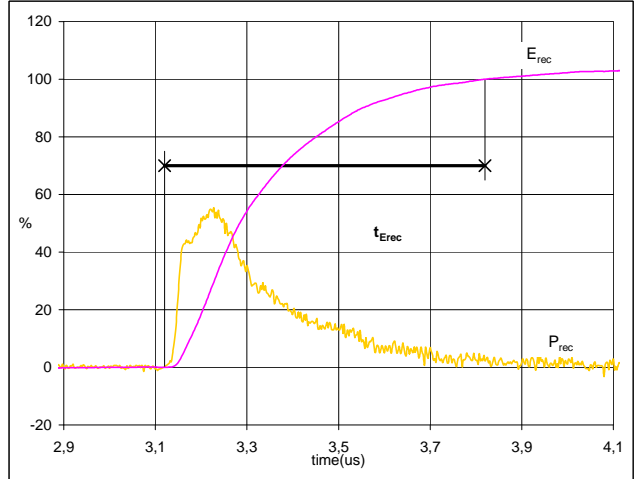

P_{rec} (100%) =	20,98	kW
E_{rec} (100%) =	2,83	mJ
t_{Erec} =	0,70	μs

Ordering Code and Marking - Outline - Pinout
Ordering Code & Marking

Version	Ordering Code	in DataMatrix as	in packaging barcode as
without thermal paste 17mm housing	V23990-P828-F10-PM	P828-F10	P828-F10

Outline

Pin table		
Pin	X	Y
1	52,6	0
2	49,9	0
3	42,65	0
4	39,65	0
5	35,15	2,8
6	28,4	0
7	24	2,8
8	21	0
9	12,2	0
10	9,2	0
11	2,7	0
12	0	0
13	0	14,65
14	2,7	14,65
15	0	28,6
16	2,7	28,6
17	5,4	28,6
18	9,6	28,6
19	12,6	28,6
20	19,6	28,6
21	22,3	28,6
22	25	28,6
23	29,7	28,6
24	32,7	28,6
25	39,7	28,6
26	42,7	28,6
27	42,2	28,6
28	49,9	28,6
29	52,6	28,6
30	52,6	14,56
31	49,9	14,56

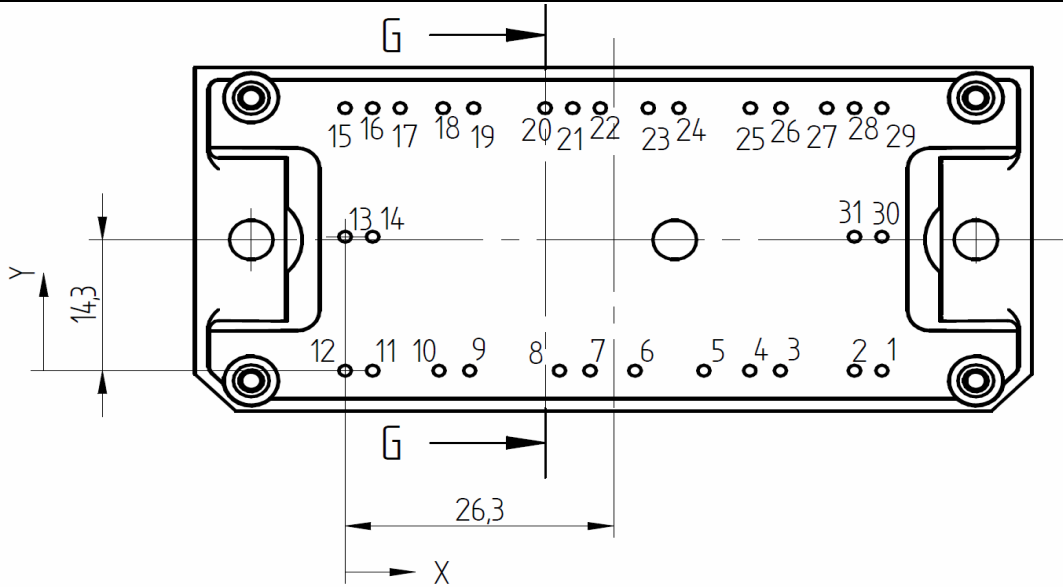
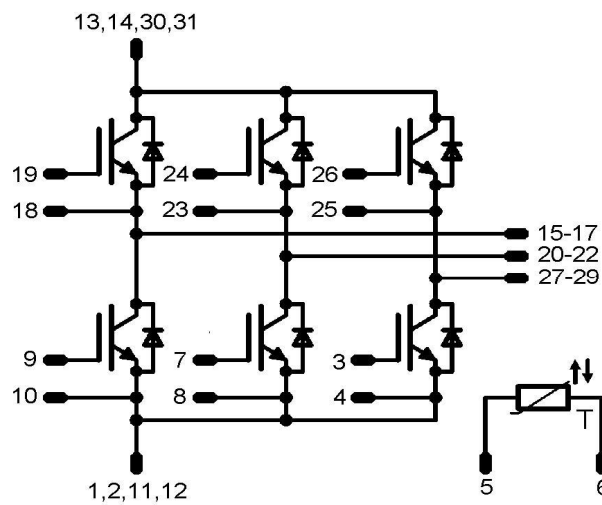
Pinout

DISCLAIMER

The information given in this datasheet describes the type of component and does not represent assured characteristics. For tested values please contact Vincotech. Vincotech reserves the right to make changes without further notice to any products herein to improve reliability, function or design. Vincotech does not assume any liability arising out of the application or use of any product or circuit described herein; neither does it convey any license under its patent rights, nor the rights of others.

LIFE SUPPORT POLICY

Vincotech products are not authorised for use as critical components in life support devices or systems without the express written approval of Vincotech.

As used herein:

1. Life support devices or systems are devices or systems which, (a) are intended for surgical implant into the body, or (b) support or sustain life, or (c) whose failure to perform when properly used in accordance with instructions for use provided in labelling can be reasonably expected to result in significant injury to the user.
2. A critical component is any component of a life support device or system whose failure to perform can be reasonably expected to cause the failure of the life support device or system, or to affect its safety or effectiveness.