

flowPACK 1 3rd gen

600V/100A

Features

- Compact flow1 housing
- Trench Fieldstop IGBT3 Technology
- Compact and Low Inductance Design
- AlN substrate for improved performance
- Built-in NTC

Target Applications

- Motor Drive
- Power Generation
- UPS

Types

- V23990-P825-F

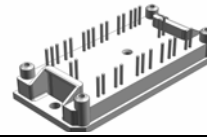
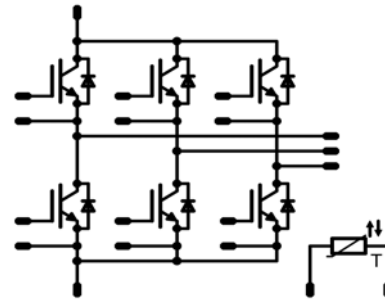
flow1 housing

Schematic

Maximum Ratings

 $T_j=25^\circ\text{C}$, unless otherwise specified

| Parameter | Symbol | Condition | Value | Unit |
|--------------------------------------|----------------------|--|----------|--------------------|
| Inverter Transistor | | | | |
| Collector-emitter break down voltage | V_{CE} | | 600 | V |
| DC collector current | I_C | $T_j=T_{jmax}$ $T_h=80^\circ\text{C}$ $T_c=80^\circ\text{C}$ | 100 | A |
| Repetitive peak collector current | I_{Cpulse} | t_p limited by T_{jmax} | 300 | A |
| Power dissipation per IGBT | P_{tot} | $T_j=T_{jmax}$ $T_h=80^\circ\text{C}$ $T_c=80^\circ\text{C}$ | 190 | W |
| Gate-emitter peak voltage | V_{GE} | | ± 20 | V |
| Short circuit ratings | t_{SC} V_{CC} | $T_j \leq 150^\circ\text{C}$ $V_{GE}=15\text{V}$ | 6 360 | μs V |
| Maximum Junction Temperature | T_{jmax} | | 175 | $^\circ\text{C}$ |
| Inverter Diode | | | | |
| Peak Repetitive Reverse Voltage | V_{RRM} | $T_j=25^\circ\text{C}$ | 600 | V |
| DC forward current | I_F | $T_j=T_{jmax}$ $T_h=80^\circ\text{C}$ $T_c=80^\circ\text{C}$ | 94 | A |
| Repetitive peak forward current | I_{FRM} | t_p limited by T_{jmax} | 300 | A |
| Power dissipation per Diode | P_{tot} | $T_j=T_{jmax}$ $T_h=80^\circ\text{C}$ $T_c=80^\circ\text{C}$ | 139 | W |
| Maximum Junction Temperature | T_{jmax} | | 175 | $^\circ\text{C}$ |

Maximum Ratings

T_j=25°C, unless otherwise specified

| Parameter | Symbol | Condition | Value | Unit |
|-----------|--------|-----------|-------|------|
|-----------|--------|-----------|-------|------|

Thermal Properties

| | | | | |
|---|------------------|--|------------|----|
| Storage temperature | T _{stg} | | -40...+125 | °C |
| Operation temperature under switching condition | T _{op} | | -40...+150 | °C |

Insulation Properties

| | | | | |
|--------------------|-----------------|------------------|----------|----|
| Insulation voltage | V _{is} | t=2 s DC voltage | 4000 | V |
| Creepage distance | | | min 12,7 | mm |
| Clearance | | | min 12,7 | mm |

Characteristic Values

| Parameter | Symbol | Conditions | | | | | Value | | | Unit |
|---|-----------------|---|--|----------------------------------|--------|---|-------|--------------|------|------|
| | | $V_{GE}[V]$ or $V_{GS}[V]$ | $V_r[V]$ or $V_{CE}[V]$ or $V_{DS}[V]$ | $I_c[A]$ or $I_F[A]$ or $I_D[A]$ | T_j | Min | Typ | Max | | |
| Inverter Transistor | | | | | | | | | | |
| Gate emitter threshold voltage | $V_{GE(th)}$ | VCE=VGE | | | 0,0016 | T _J =25°C T _J =150°C | 5 | 5,8 | 6,5 | V |
| Collector-emitter saturation voltage | $V_{CE(sat)}$ | | 15 | | 100 | T _J =25°C T _J =150°C | 1,1 | 1,54 1,76 | 2,25 | V |
| Collector-emitter cut-off current incl. Diode | I_{CES} | | 0 | 600 | | T _J =25°C T _J =150°C | | | 0,66 | mA |
| Gate-emitter leakage current | I_{GES} | | 20 | 0 | | T _J =25°C T _J =150°C | | | 650 | nA |
| Integrated Gate resistor | R_{gnt} | | | | | | | 2 | | Ω |
| Turn-on delay time | $t_{d(on)}$ | R _{goff} =4 Ω R _{gon} =4 Ω | ±15 | 300 | 100 | T _J =25°C | | 151 | | ns |
| Rise time | t_r | | | | | T _J =150°C | | 157 | | |
| Turn-off delay time | $t_{d(off)}$ | | | | | T _J =25°C | | 19 | | |
| Fall time | t_f | | | | | T _J =150°C | | 25 | | |
| Turn-on energy loss per pulse | E_{on} | | | | | T _J =25°C | | 205 | | |
| Turn-off energy loss per pulse | E_{off} | | | | | T _J =150°C | | 232 | | |
| Input capacitance | C_{iss} | | | | | T _J =25°C | | 6160 | | pF |
| Output capacitance | C_{oss} | f=1MHz | 0 | 25 | | T _J =25°C | | 384 | | |
| Reverse transfer capacitance | C_{iss} | | | | | T _J =25°C | | 183 | | |
| Gate charge | Q_{Gate} | V _{CC} =480V | ±15 | | 100 | T _J =25°C | | 625 | | nC |
| Thermal resistance chip to heatsink per chip | R_{thJH} | Thermal foil thickness=76um Kunze foil KU-ALF5 | | | | | | 0,50 | | K/W |
| Inverter Diode | | | | | | | | | | |
| Diode forward voltage | V_F | | | | 100 | T _J =25°C T _J =150°C | 1,2 | 1,65 1,53 | 2,4 | V |
| Peak reverse recovery current | I_{RRM} | R _{goff} =4 Ω | ±15 | 300 | 100 | T _J =25°C | | 97 | | A |
| Reverse recovery time | t_{rr} | | | | | T _J =150°C | | 117 | | |
| Reverse recovered charge | Q_{rr} | | | | | T _J =25°C | | 140 | | |
| Peak rate of fall of recovery current | $di(rec)max/dt$ | | | | | T _J =150°C | | 292 | | |
| Reverse recovered energy | E_{rec} | | | | | T _J =25°C | | 4,87 | | |
| | | | | | | T _J =150°C | | 10,01 | | |
| Thermal resistance chip to heatsink per chip | R_{thJH} | Thermal foil thickness=76um Kunze foil KU-ALF5 | | | | | | 0,68 | | K/W |
| Thermistor | | | | | | | | | | |
| Rated resistance | R_{25} | Tol. ±5% | | | | T _J =25°C | 4,2 | 4,7 | 5,8 | kΩ |
| Deviation of R100 | $D_{R/R}$ | R100=435Ω | | | | T _C =100°C | | 2,6 | | %/K |
| Power dissipation given Epcos-Typ | P | | | | | T _J =25°C | | 210 | | mW |
| B-value | $B_{(25/100)}$ | Tol. ±3% | | | | T _J =25°C | | 3530 | | K |

Output Inverter

Figure 1 Output inverter IGBT

Typical output characteristics

$I_C = f(V_{CE})$

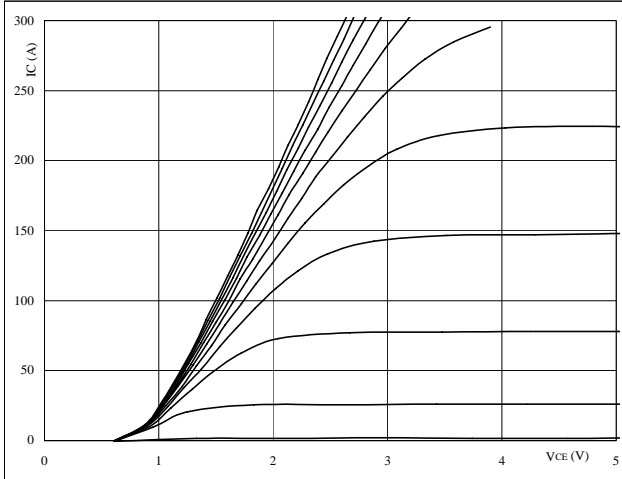
At

$t_p = 250 \mu s$

$T_j = 25 \text{ } ^\circ C$

 V_{GE} from 7 V to 17 V in steps of 1 V

Figure 2 Output inverter IGBT

Typical output characteristics

$I_C = f(V_{CE})$

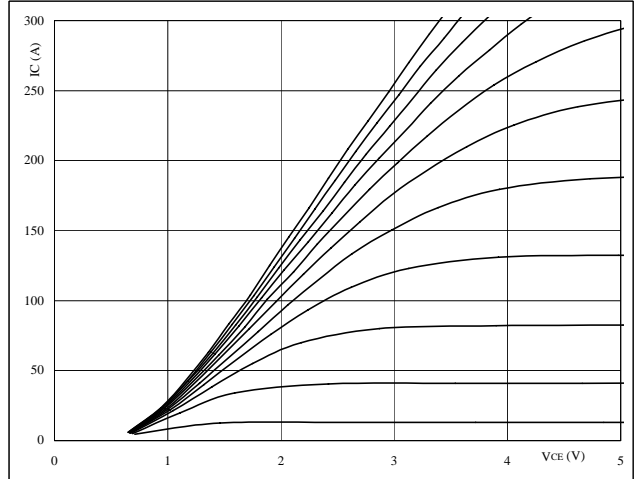
At

$t_p = 250 \mu s$

$T_j = 150 \text{ } ^\circ C$

 V_{GE} from 7 V to 17 V in steps of 1 V

Figure 3 Output inverter IGBT

Typical transfer characteristics

$I_C = f(V_{GE})$

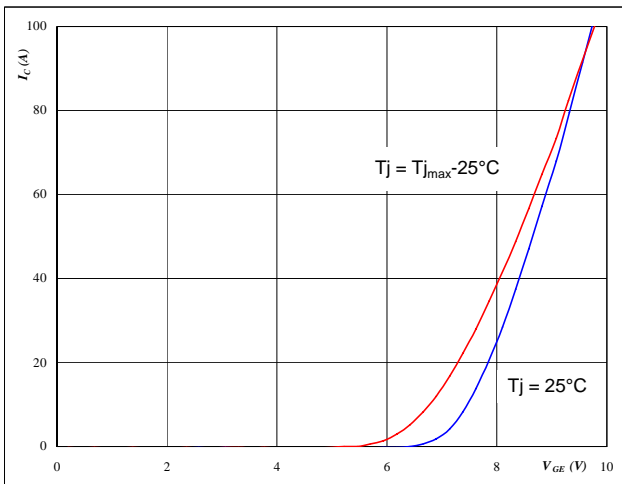
At

$t_p = 250 \mu s$

$V_{CE} = 10 V$

Figure 4 Output inverter FRED

Typical diode forward current as a function of forward voltage

$I_F = f(V_F)$

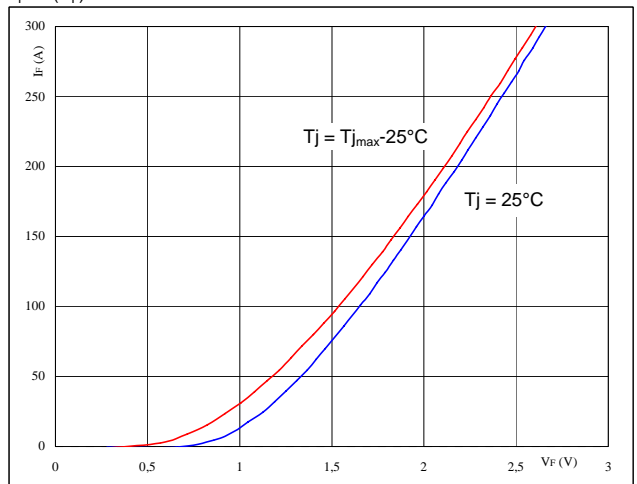

At

$t_p = 250 \mu s$

Output Inverter

Figure 5 Output inverter IGBT

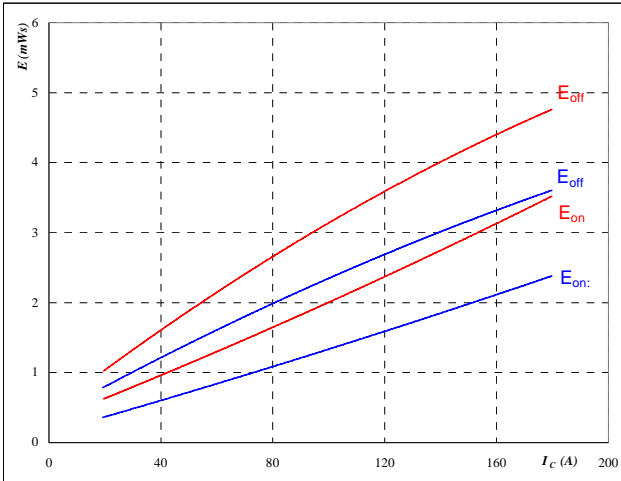
Typical switching energy losses
 as a function of collector current
 $E = f(I_c)$



With an inductive load at
 $T_j = 25/150 \text{ } ^\circ\text{C}$
 $V_{CE} = 300 \text{ V}$
 $V_{GE} = \pm 15 \text{ V}$
 $R_{gon} = 4 \text{ } \Omega$
 $R_{goff} = 4 \text{ } \Omega$

Figure 6 Output inverter IGBT

Typical switching energy losses
 as a function of gate resistor
 $E = f(R_G)$

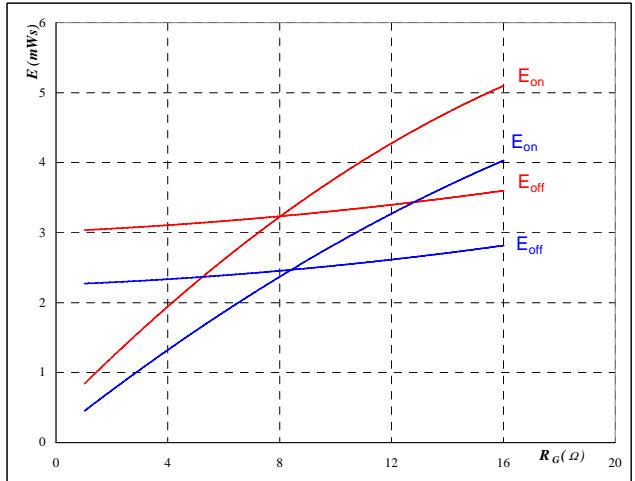

With an inductive load at
 $T_j = 25/150 \text{ } ^\circ\text{C}$
 $V_{CE} = 300 \text{ V}$
 $V_{GE} = \pm 15 \text{ V}$
 $I_c = 100 \text{ A}$

Figure 7 Output inverter IGBT

Typical reverse recovery energy loss
 as a function of collector current
 $E_{rec} = f(I_c)$

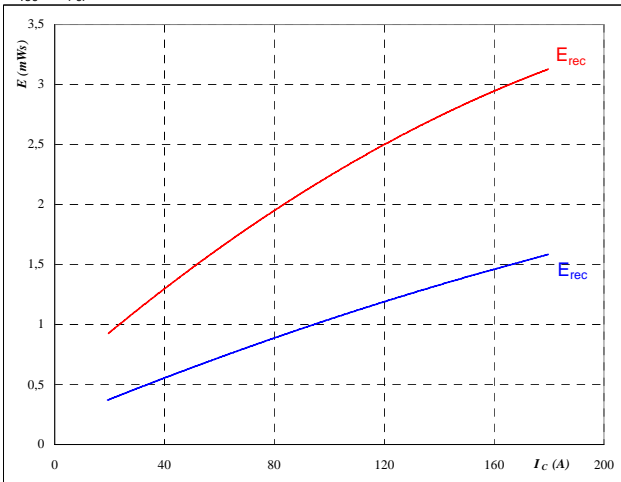

With an inductive load at
 $T_j = 25/150 \text{ } ^\circ\text{C}$
 $V_{CE} = 300 \text{ V}$
 $V_{GE} = \pm 15 \text{ V}$
 $R_{gon} = 4 \text{ } \Omega$

Figure 8 Output inverter IGBT

Typical reverse recovery energy loss
 as a function of gate resistor
 $E_{rec} = f(R_G)$

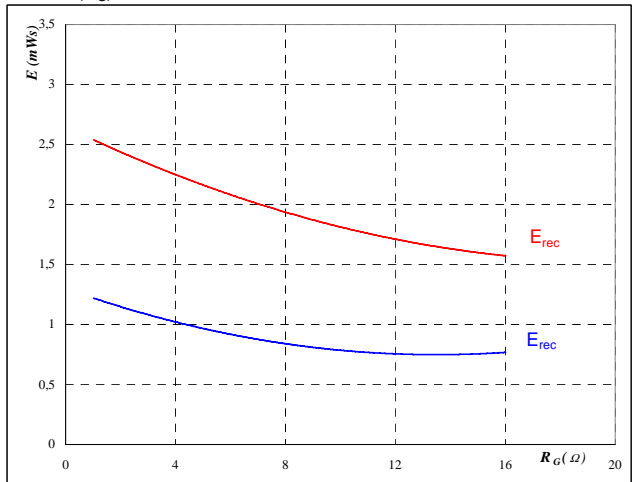

With an inductive load at
 $T_j = 25/150 \text{ } ^\circ\text{C}$
 $V_{CE} = 300 \text{ V}$
 $V_{GE} = \pm 15 \text{ V}$
 $I_c = 100 \text{ A}$

Output Inverter
Figure 9 Output inverter IGBT

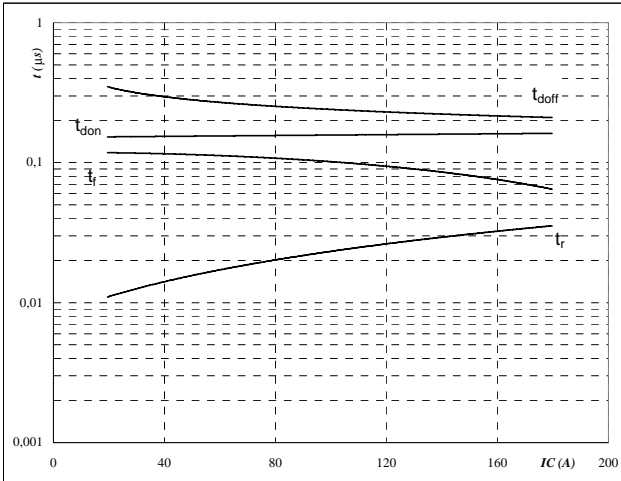
Typical switching times as a function of collector current
 $t = f(I_C)$

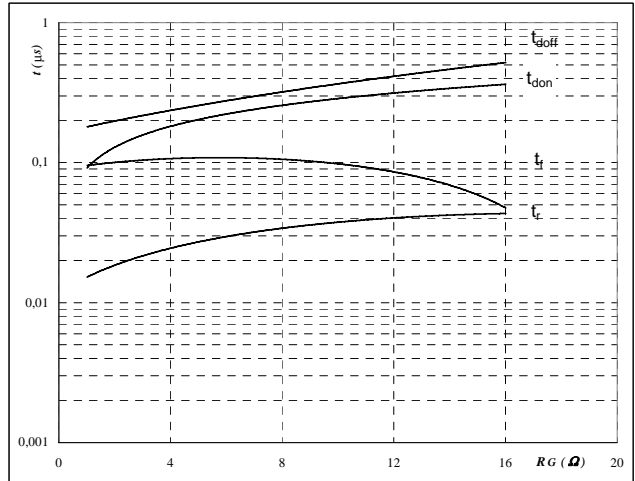
 With an inductive load at
 $T_j = 150 \text{ } ^\circ\text{C}$
 $V_{CE} = 300 \text{ V}$
 $V_{GE} = \pm 15 \text{ V}$
 $R_{gon} = 4 \text{ } \Omega$
 $R_{goff} = 4 \text{ } \Omega$
Figure 10 Output inverter IGBT

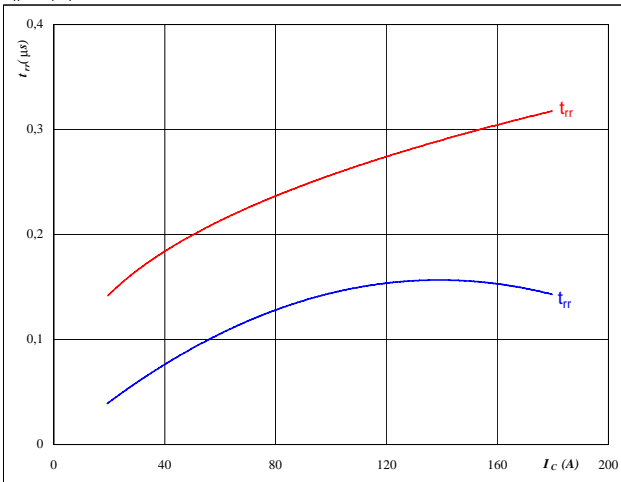
Typical switching times as a function of gate resistor
 $t = f(R_G)$

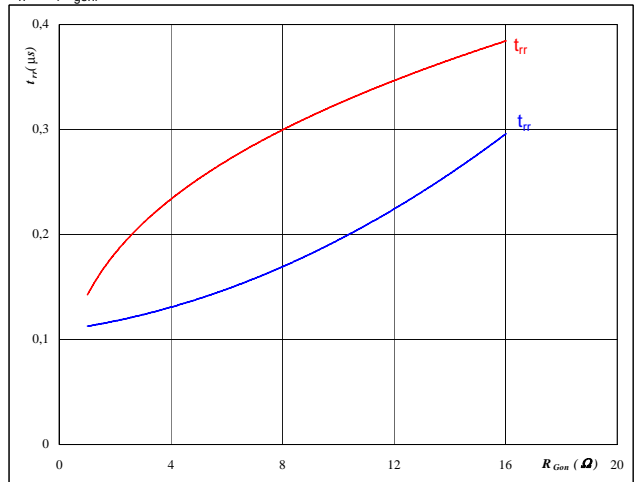
 With an inductive load at
 $T_j = 150 \text{ } ^\circ\text{C}$
 $V_{CE} = 300 \text{ V}$
 $V_{GE} = \pm 15 \text{ V}$
 $I_C = 100 \text{ A}$
Figure 11 Output inverter FRED

Typical reverse recovery time as a function of collector current
 $t_{rr} = f(I_C)$

At
 $T_j = 25/150 \text{ } ^\circ\text{C}$
 $V_{CE} = 300 \text{ V}$
 $V_{GE} = \pm 15 \text{ V}$
 $R_{gon} = 4 \text{ } \Omega$
Figure 12 Output inverter FRED

Typical reverse recovery time as a function of IGBT turn on gate resistor
 $t_{rr} = f(R_{gon})$

At
 $T_j = 25/150 \text{ } ^\circ\text{C}$
 $V_R = 300 \text{ V}$
 $I_F = 100 \text{ A}$
 $V_{GE} = \pm 15 \text{ V}$

Output Inverter

Figure 13 Output inverter FRED

Typical reverse recovery charge as a function of collector current

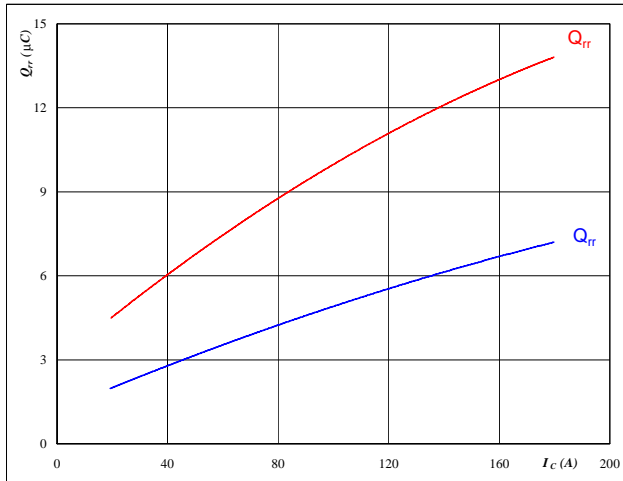
$$Q_{rr} = f(I_c)$$



At

| | | |
|-------------|--------|----|
| $T_j =$ | 25/150 | °C |
| $V_{CE} =$ | 300 | V |
| $V_{GE} =$ | ±15 | V |
| $R_{gon} =$ | 4 | Ω |

Figure 14 Output inverter FRED

Typical reverse recovery charge as a function of IGBT turn on gate resistor

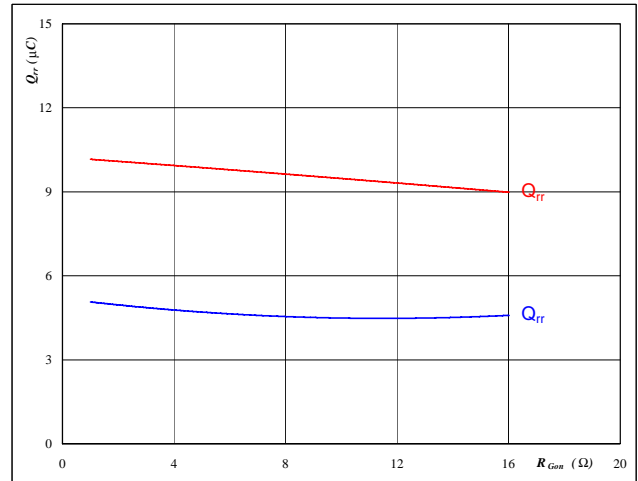
$$Q_{rr} = f(R_{gon})$$



At

| | | |
|------------|--------|----|
| $T_j =$ | 25/150 | °C |
| $V_R =$ | 300 | V |
| $I_F =$ | 100 | A |
| $V_{GE} =$ | ±15 | V |

Figure 15 Output inverter FRED

Typical reverse recovery current as a function of collector current

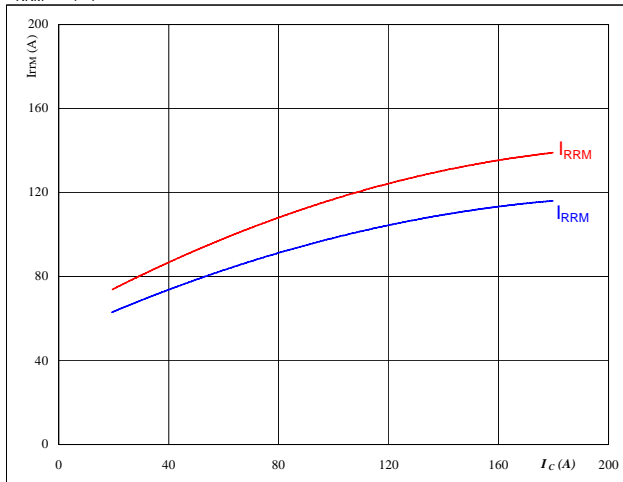
$$I_{RRM} = f(I_c)$$



At

| | | |
|-------------|--------|----|
| $T_j =$ | 25/150 | °C |
| $V_{CE} =$ | 300 | V |
| $V_{GE} =$ | ±15 | V |
| $R_{gon} =$ | 4 | Ω |

Figure 16 Output inverter FRED

Typical reverse recovery current as a function of IGBT turn on gate resistor

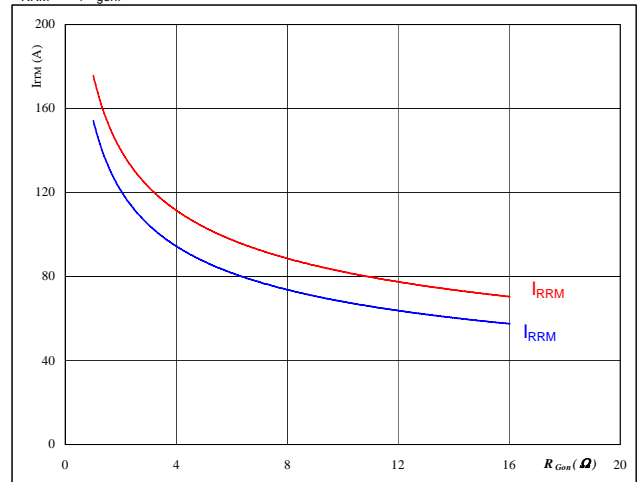
$$I_{RRM} = f(R_{gon})$$

At

| | | |
|------------|--------|----|
| $T_j =$ | 25/150 | °C |
| $V_R =$ | 300 | V |
| $I_F =$ | 100 | A |
| $V_{GE} =$ | ±15 | V |

Output Inverter

Figure 17 Output inverter FRED

Typical rate of fall of forward and reverse recovery current as a function of collector current

$$dI_0/dt, dI_{rec}/dt = f(I_C)$$

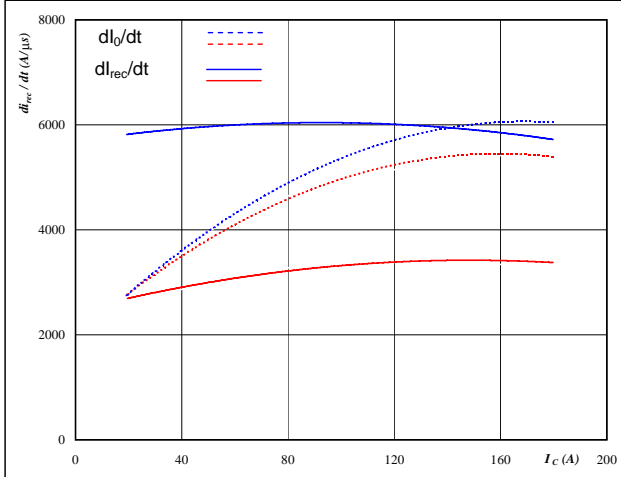

At
 $T_j = 25/150$ °C
 $V_{CE} = 300$ V
 $V_{GE} = \pm 15$ V
 $R_{gon} = 4$ Ω

Figure 18 Output inverter FRED

Typical rate of fall of forward and reverse recovery current as a function of IGBT turn on gate resistor

$$dI_0/dt, dI_{rec}/dt = f(R_{gon})$$

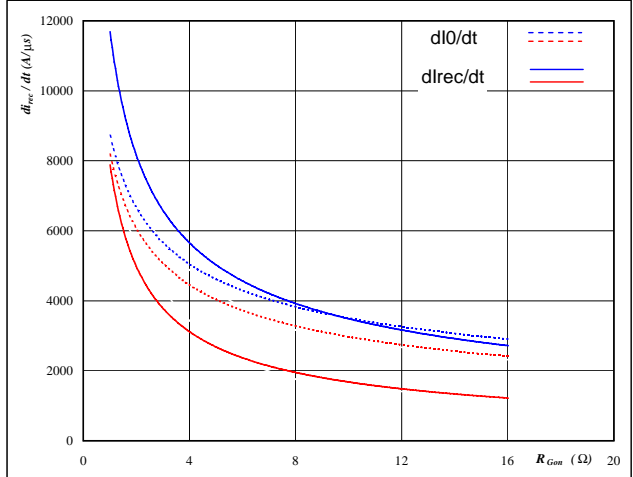

At
 $T_j = 25/150$ °C
 $V_R = 300$ V
 $I_F = 100$ A
 $V_{GE} = \pm 15$ V

Figure 19 Output inverter IGBT

IGBT transient thermal impedance as a function of pulse width

$$Z_{thJH} = f(tp)$$

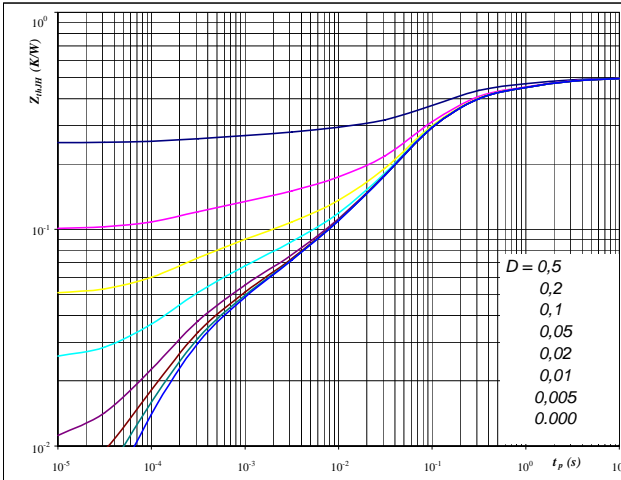

At
 $D = tp / T$
 $R_{thJH} = 0,50$ K/W

IGBT thermal model values

| R (C/W) | Tau (s) |
|---------|---------|
| 0,02 | 1,0E+01 |
| 0,08 | 1,3E+00 |
| 0,17 | 1,6E-01 |
| 0,16 | 5,7E-02 |
| 0,03 | 5,3E-03 |
| 0,02 | 7,6E-04 |
| 0,02 | 1,6E-04 |

Figure 20 Output inverter FRED

FRED transient thermal impedance as a function of pulse width

$$Z_{thJH} = f(tp)$$

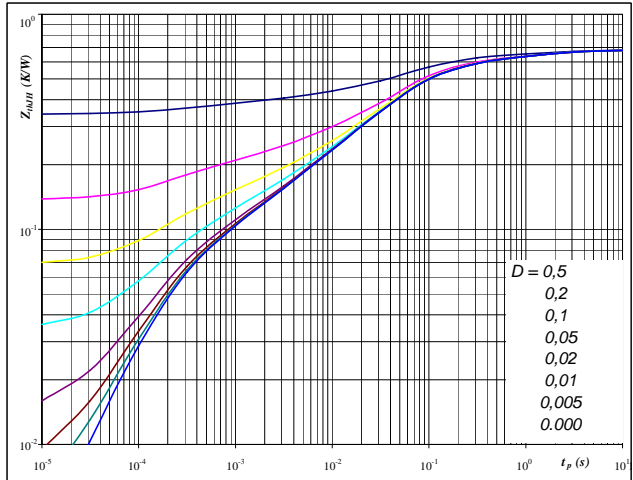

At
 $D = tp / T$
 $R_{thJH} = 0,68$ K/W

FRED thermal model values

| R (C/W) | Tau (s) |
|---------|---------|
| 0,02 | 1,0E+01 |
| 0,08 | 1,3E+00 |
| 0,13 | 1,6E-01 |
| 0,27 | 4,3E-02 |
| 0,08 | 6,0E-03 |
| 0,05 | 9,5E-04 |
| 0,05 | 1,9E-04 |

Output Inverter

Figure 21 Output inverter IGBT

Power dissipation as a function of heatsink temperature

$$P_{tot} = f(T_h)$$

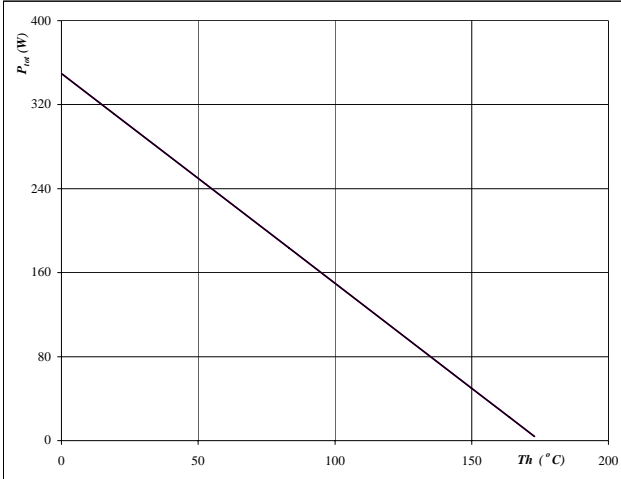
At
 $T_j = 175 \text{ } ^\circ\text{C}$
Figure 22 Output inverter IGBT

Collector current as a function of heatsink temperature

$$I_C = f(T_h)$$

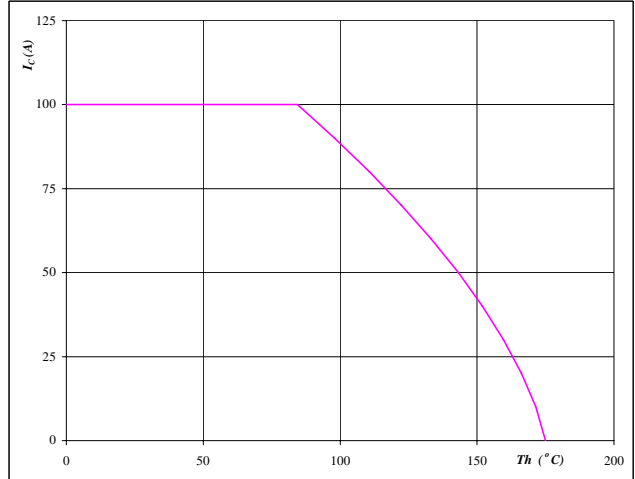
At
 $T_j = 175 \text{ } ^\circ\text{C}$
 $V_{GE} = 15 \text{ V}$
Figure 23 Output inverter FRED

Power dissipation as a function of heatsink temperature

$$P_{tot} = f(T_h)$$

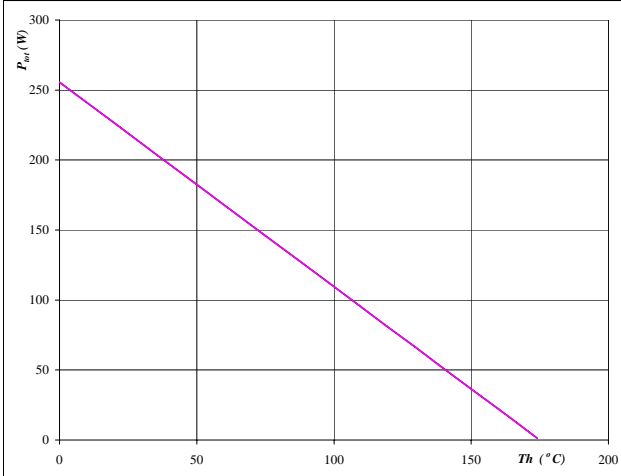
At
 $T_j = 175 \text{ } ^\circ\text{C}$
Figure 24 Output inverter FRED

Forward current as a function of heatsink temperature

$$I_F = f(T_h)$$

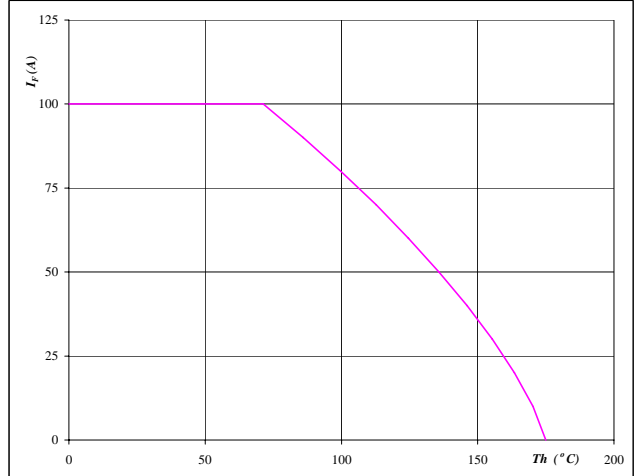

At
 $T_j = 175 \text{ } ^\circ\text{C}$

Output Inverter

Figure 25 Output inverter IGBT

Safe operating area as a function of collector-emitter voltage

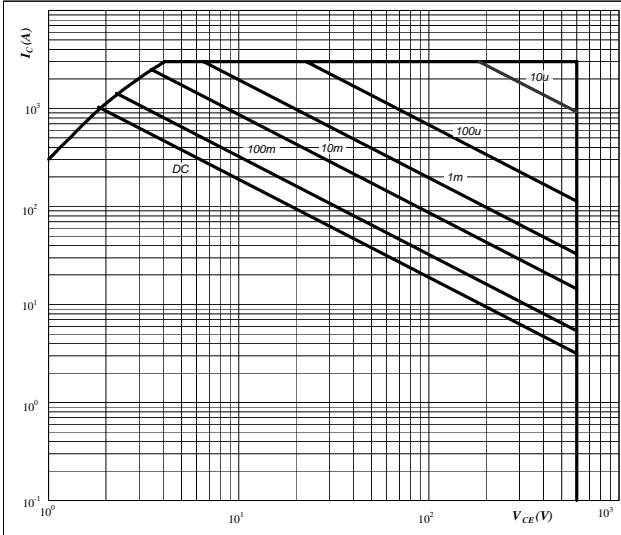
$$I_C = f(V_{CE})$$



At
 D = single pulse
 Th = 80 °C
 V_{GE} = ±15 V
 T_j = T_{jmax} °C

Figure 26 Output inverter IGBT

Gate voltage vs Gate charge

$$V_{GE} = f(Q_g)$$

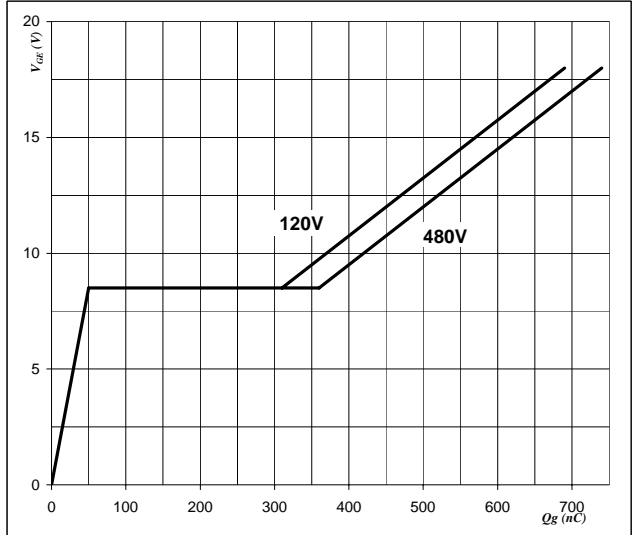

At
 I_C = 100 A

Thermistor

Figure 1 Thermistor

**Typical NTC characteristic
as a function of temperature**

$R_T = f(T)$

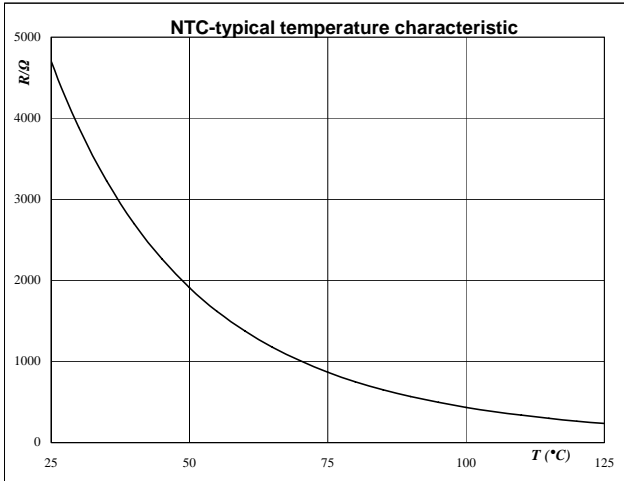

Switching Definitions Output Inverter

| General conditions | |
|--------------------|----------|
| T_j | = 150 °C |
| R_{gon} | = 4 Ω |
| R_{goff} | = 4 Ω |

Figure 1 Output inverter IGBT

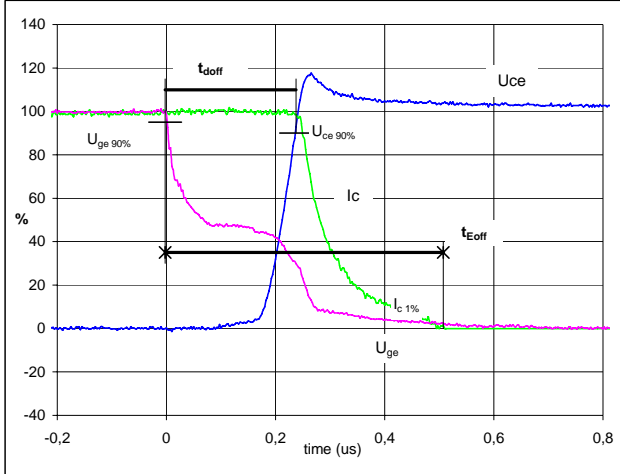
Turn-off Switching Waveforms & definition of t_{doff} , t_{Eoff}
 (t_{Eoff} = integrating time for E_{off})

| | | |
|-------------------|------|----|
| V_{GE} (0%) = | -15 | V |
| V_{GE} (100%) = | 15 | V |
| V_C (100%) = | 300 | V |
| I_C (100%) = | 99 | A |
| t_{doff} = | 0,23 | μs |
| t_{Eoff} = | 0,51 | μs |

Figure 2 Output inverter IGBT

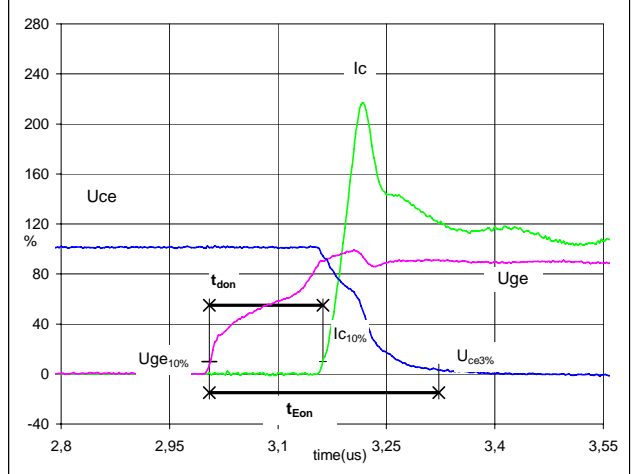
Turn-on Switching Waveforms & definition of t_{don} , t_{Eon}
 (t_{Eon} = integrating time for E_{on})

| | | |
|-------------------|------|----|
| V_{GE} (0%) = | -15 | V |
| V_{GE} (100%) = | 15 | V |
| V_C (100%) = | 300 | V |
| I_C (100%) = | 99 | A |
| t_{don} = | 0,16 | μs |
| t_{Eon} = | 0,32 | μs |

Figure 3 Output inverter IGBT

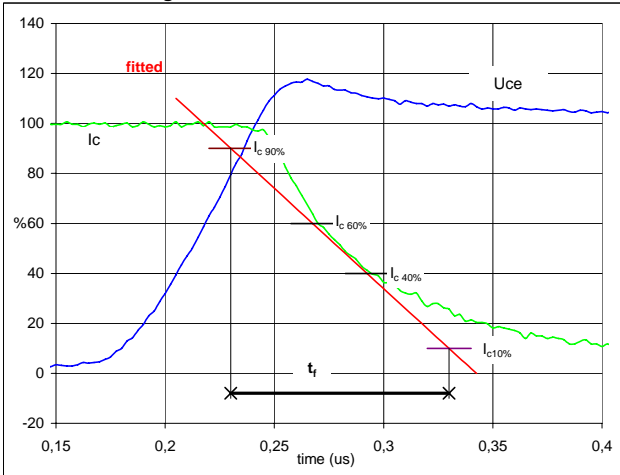
Turn-off Switching Waveforms & definition of t_f

| | | |
|----------------|------|----|
| V_C (100%) = | 300 | V |
| I_C (100%) = | 99 | A |
| t_f = | 0,10 | μs |

Figure 4 Output inverter IGBT

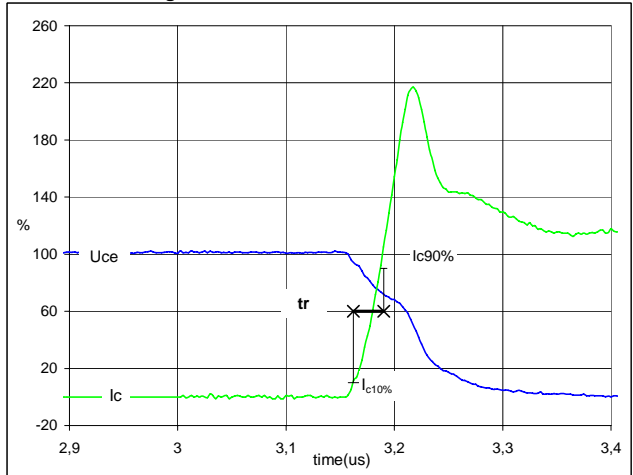
Turn-on Switching Waveforms & definition of t_r

| | | |
|----------------|------|----|
| V_C (100%) = | 300 | V |
| I_C (100%) = | 99 | A |
| t_r = | 0,03 | μs |

Switching Definitions Output Inverter

Figure 5 Output inverter IGBT

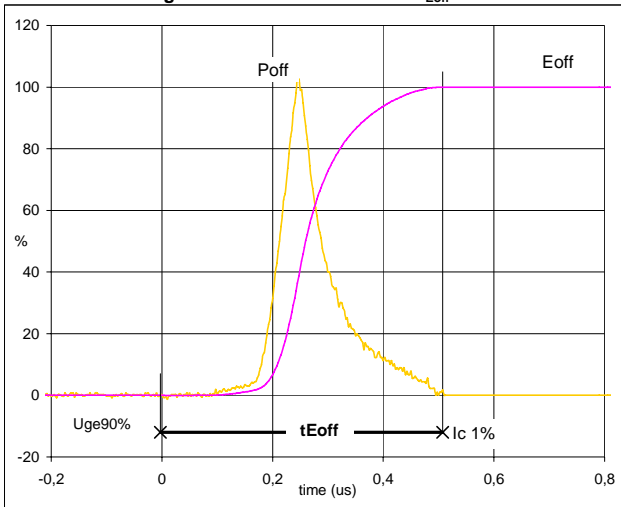
Turn-off Switching Waveforms & definition of t_{Eoff}

$P_{off}(100\%) = 29,79$ kW
 $E_{off}(100\%) = 3,11$ mJ
 $t_{Eoff} = 0,51$ μ s

Figure 6 Output inverter IGBT

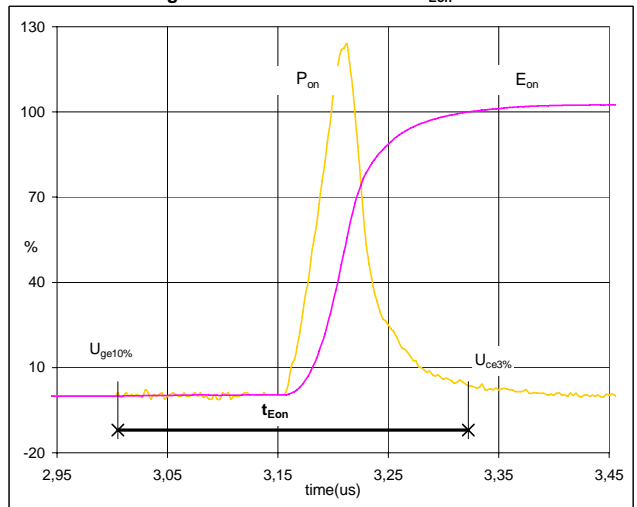
Turn-on Switching Waveforms & definition of t_{Eon}

$P_{on}(100\%) = 29,79$ kW
 $E_{on}(100\%) = 2,00$ mJ
 $t_{Eon} = 0,32$ μ s

Figure 7 Output inverter FRED

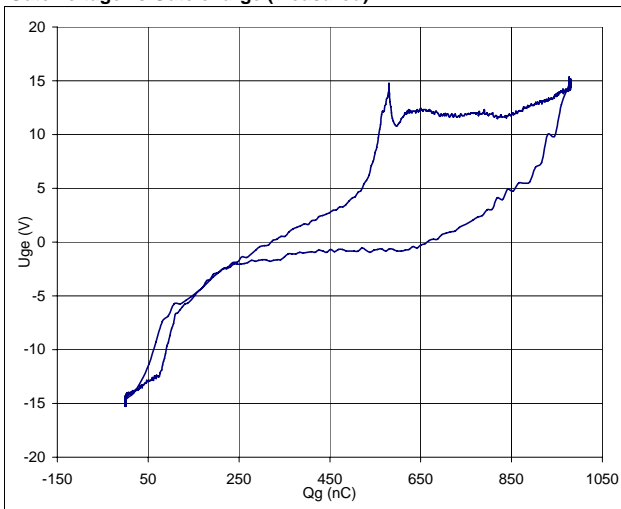
Gate voltage vs Gate charge (measured)

$V_{GEoff} = -15$ V
 $V_{GEon} = 15$ V
 $V_C(100\%) = 300$ V
 $I_C(100\%) = 99$ A
 $Q_g = 979,79$ nC

Figure 8 Output inverter IGBT

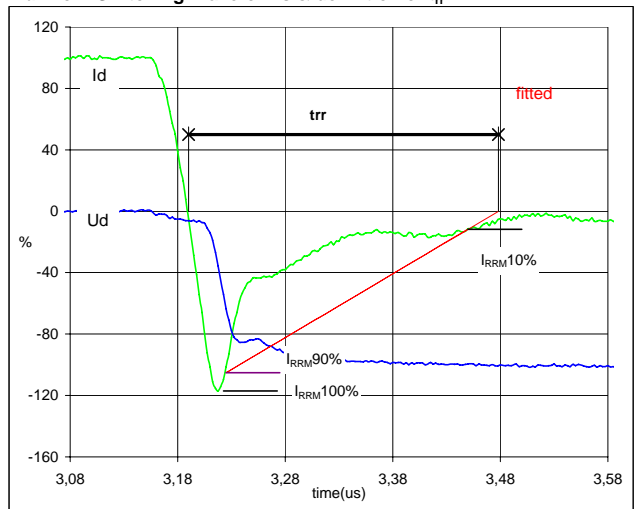
Turn-off Switching Waveforms & definition of t_{tr}

$V_d(100\%) = 300$ V
 $I_d(100\%) = 99$ A
 $I_{RRM}(100\%) = -117$ A
 $t_{tr} = 0,29$ μ s

Switching Definitions Output Inverter

Figure 9 Output inverter FRED

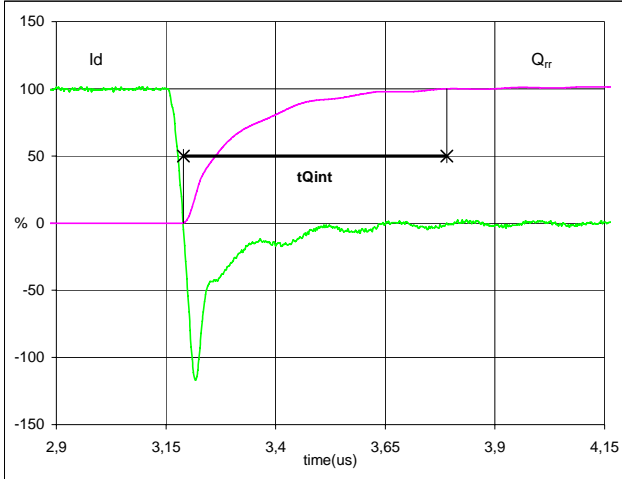
Turn-on Switching Waveforms & definition of t_{Qrr}
 (t_{Qrr} = integrating time for Q_{rr})

| | | |
|-------------------|-------|---------------|
| I_d (100%) = | 99 | A |
| Q_{rr} (100%) = | 10,01 | μC |
| t_{Qint} = | 0,60 | μs |

Figure 10 Output inverter FRED

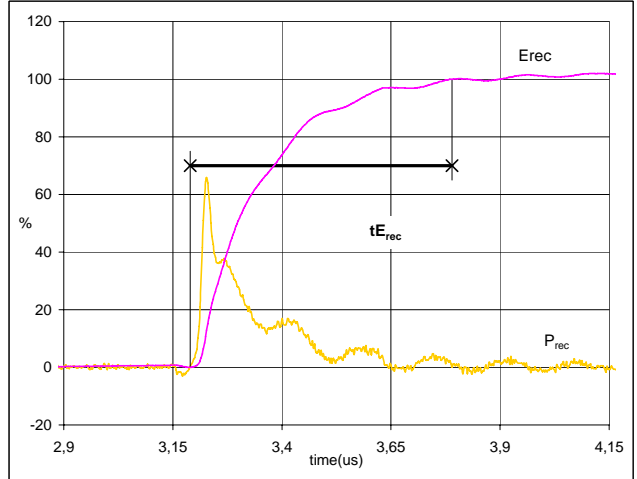
Turn-on Switching Waveforms & definition of t_{Erec}
 (t_{Erec} = integrating time for E_{rec})

| | | |
|--------------------|-------|---------------|
| P_{rec} (100%) = | 29,79 | kW |
| E_{rec} (100%) = | 2,25 | mJ |
| t_{Erec} = | 0,60 | μs |

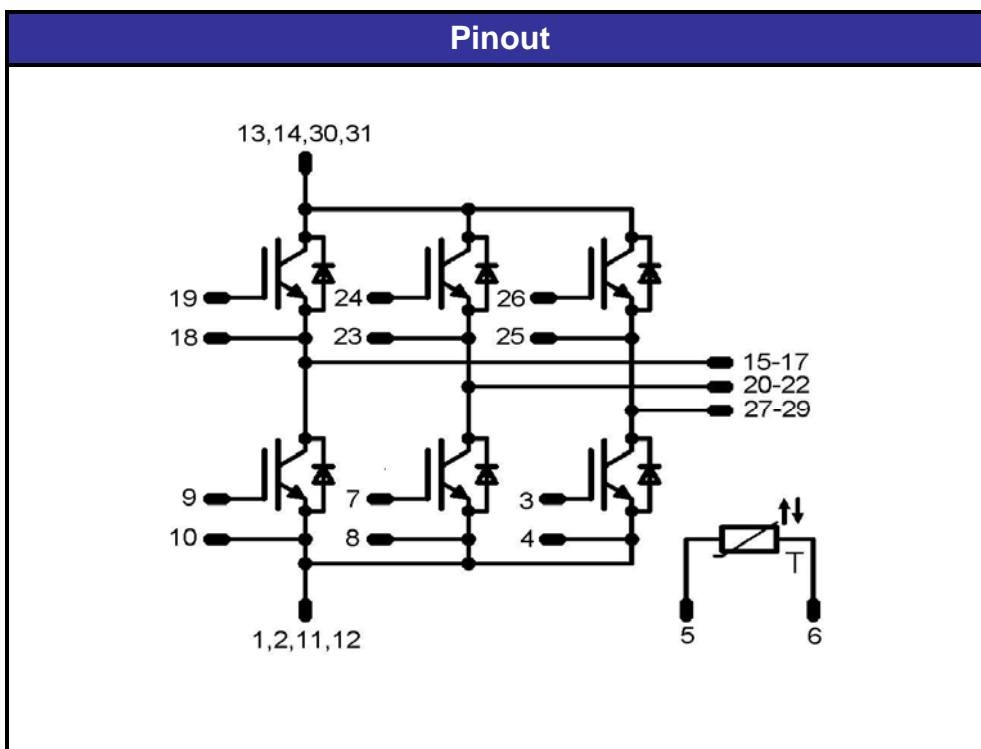
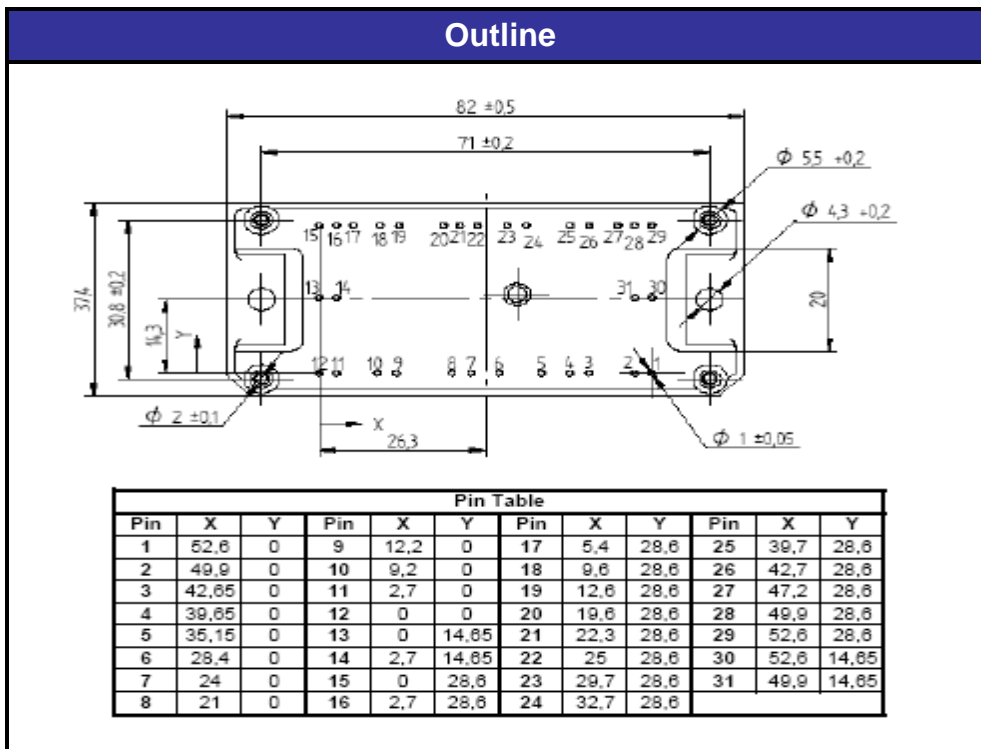
Package Outline and Pinout

PRODUCT STATUS DEFINITIONS

| Datasheet Status | Product Status | Definition |
|------------------|------------------------|--|
| Target | Formative or In Design | This datasheet contains the design specifications for product development. Specifications may change in any manner without notice. The data contained is exclusively intended for technically trained staff. |
| Preliminary | First Production | This datasheet contains preliminary data, and supplementary data may be published at a later date. Vincotech reserves the right to make changes at any time without notice in order to improve design. The data contained is exclusively intended for technically trained staff. |
| Final | Full Production | This datasheet contains final specifications. Vincotech reserves the right to make changes at any time without notice in order to improve design. The data contained is exclusively intended for technically trained staff. |

DISCLAIMER

The information given in this datasheet describes the type of component and does not represent assured characteristics. For tested values please contact Vincotech. Vincotech reserves the right to make changes without further notice to any products herein to improve reliability, function or design. Vincotech does not assume any liability arising out of the application or use of any product or circuit described herein; neither does it convey any license under its patent rights, nor the rights of others.

LIFE SUPPORT POLICY

Vincotech products are not authorised for use as critical components in life support devices or systems without the express written approval of Vincotech.

As used herein:

1. Life support devices or systems are devices or systems which, (a) are intended for surgical implant into the body, or (b) support or sustain life, or (c) whose failure to perform when properly used in accordance with instructions for use provided in labelling can be reasonably expected to result in significant injury to the user.
2. A critical component is any component of a life support device or system whose failure to perform can be reasonably expected to cause the failure of the life support device or system, or to affect its safety or effectiveness.