

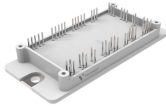
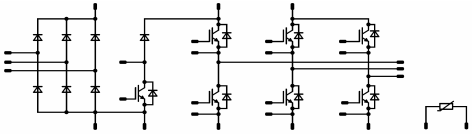

<i>flow PIM 2</i>	<b>600 V / 100 A</b>
<div style="background-color: #eee; padding: 2px; margin-bottom: 5px;"><b>Features</b></div> <ul style="list-style-type: none"> <li>Three-phase rectifier, BRC, Inverter, NTC</li> <li>Very Compact housing, easy to route</li> <li>IGBT3/ EmCon3 technology for low saturation losses and improved EMC behavior</li> </ul>	<div style="background-color: #eee; padding: 2px; margin-bottom: 5px;"><b>flow 2 17mm housing</b></div> <div style="display: flex; justify-content: space-around;"> <div style="text-align: center;">  Press fit pins         </div> <div style="text-align: center;">  Solder pins         </div> </div>
<div style="background-color: #eee; padding: 2px; margin-bottom: 5px;"><b>Target Applications</b></div> <ul style="list-style-type: none"> <li>Motor Drives</li> <li>Power Generation</li> </ul>	<div style="background-color: #eee; padding: 2px; margin-bottom: 5px;"><b>Schematic</b></div> 
<div style="background-color: #eee; padding: 2px; margin-bottom: 5px;"><b>Types</b></div> <ul style="list-style-type: none"> <li>V23990-P765-A-PM</li> <li>V23990-P765-AY-PM</li> </ul>	

## Maximum Ratings

$T_j = 25\text{ °C}$ , unless otherwise specified

Parameter	Symbol	Condition	Value	Unit
<b>Input Rectifier Diode</b>				
Repetitive peak reverse voltage	$V_{RRM}$		1600	V
Forward current	$I_{FAV}$		100	A
Surge (non-repetitive) forward current	$I_{FSM}$	$t_p = 10\text{ ms}$	1000	A
I2t-value	$I^2t$		5000	A <sup>2</sup> s
Power dissipation	$P_{tot}$	$T_j = T_{jmax}$ $T_s = 80\text{ °C}$	130	W
Maximum Junction Temperature	$T_{jmax}$		150	°C
<b>Inverter Switch</b>				
Collector-emitter breakdown voltage	$V_{CE}$		600	V
DC collector current	$I_C$		100	A
Repetitive peak collector current	$I_{CRM}$	$t_p$ limited by $T_{jmax}$	200	A
Power dissipation	$P_{tot}$	$T_j = T_{jmax}$ $T_s = 80\text{ °C}$	216	W
Gate-emitter peak voltage	$V_{GE}$		±20	V
Short circuit ratings	$t_{SC}$	$T_j \leq 150\text{ °C}$	6	µs
	$V_{CC}$	$V_{GE} = 15\text{ V}$	360	V
Maximum Junction Temperature	$T_{jmax}$		175	°C



## Maximum Ratings

 $T_j = 25\text{ °C}$ , unless otherwise specified

Parameter	Symbol	Condition	Value	Unit
-----------	--------	-----------	-------	------

### Inverter Diode

Peak Repetitive Reverse Voltage	$V_{RRM}$		600	V
DC forward current	$I_F$	$T_j = T_{jmax}$ $T_s = 80\text{ °C}$	80	A
Repetitive peak forward current	$I_{FRM}$	$t_p$ limited by $T_{jmax}$	200	A
Power dissipation	$P_{tot}$	$T_j = T_{jmax}$ $T_s = 80\text{ °C}$	131	W
Maximum Junction Temperature	$T_{jmax}$		175	°C

### Brake Switch

Collector-emitter breakdown voltage	$V_{CE}$		600	V
DC collector current	$I_C$		75	A
Repetitive peak collector current	$I_{CRM}$	$t_p$ limited by $T_{jmax}$	225	A
Power dissipation	$P_{tot}$	$T_j = T_{jmax}$ $T_s = 80\text{ °C}$	141	W
Gate-emitter peak voltage	$V_{GE}$		±20	V
Short circuit ratings	$t_{SC}$ $V_{CC}$	$T_j \leq 150\text{ °C}$ $V_{GE} = 15\text{ V}$	6 360	µs V
Maximum Junction Temperature	$T_{jmax}$		175	°C

### Brake Inverse Diode

Peak Repetitive Reverse Voltage	$V_{RRM}$		600	V
DC forward current	$I_F$		20	A
Repetitive peak forward current	$I_{FRM}$	$t_p$ limited by $T_{jmax}$	40	A
Brake Inverse Diode	$P_{tot}$	$T_j = T_{jmax}$ $T_s = 80\text{ °C}$	55	W
Maximum Junction Temperature	$T_{jmax}$		175	°C

### Brake Diode

Peak Repetitive Reverse Voltage	$V_{RRM}$		600	V
DC forward current	$I_F$		30	A
Repetitive peak forward current	$I_{FRM}$	$t_p$ limited by $T_{jmax}$	90	A
Power dissipation	$P_{tot}$	$T_j = T_{jmax}$ $T_s = 80\text{ °C}$	67	W
Maximum Junction Temperature	$T_{jmax}$		175	°C

### Thermal properties

Storage temperature	$T_{stg}$		-40...+125	°C
Operation temperature under switching condition	$T_{op}$		-40...+ $T_{jmax}$ -25	°C

### Isolation Properties

Isolation voltage	$V_{isol}$	DC Test Voltage* $t_p = 2\text{ s}$	4000	V
		AC Voltage $t_p = 1\text{ min}$	2500	V
Creepage distance			min 12,7	mm
Clearance		with Press-fit pins / with Solder pins	11,58 / 11,82	mm
Comparative Tracking Index	CTI		>200	

\* 100 % tested in production



### Characteristic Values

Parameter	Symbol	Conditions					Value			Unit	
		$V_{GE}$ [V]	$V_{GS}$ [V]	$V_r$ [V]	$V_{CE}$ [V]	$V_{DS}$ [V]	$I_C$ [A]	$I_F$ [A]	$I_D$ [A]		$T_j$ [°C]

#### Input Rectifier Diode

Forward voltage	$V_F$					100	25 125		1,2 1,16	1,9	V
Threshold voltage (for power loss calc. only)	$V_{to}$						25 125		0,91 0,77		V
Slope resistance (for power loss calc. only)	$r_t$						25 125		0,003 0,004		$\Omega$
Reverse current	$I_r$			1500			25 125			0,05 1,1	mA
Thermal resistance junction to heatsink	$R_{th(j-s)}$	$\lambda_{paste} = 3,4$ W/mK (PSX)							0,52		K/W

#### Inverter Switch

Gate emitter threshold voltage	$V_{GE(th)}$	$V_{CE} = V_{GE}$				0,0016	25	5	5,8	6,5	V
Collector-emitter saturation voltage	$V_{CESat}$		15			100	25 150		1,48 1,73	2,2	V
Collector-emitter cut-off current incl. Diode	$I_{CES}$		0	600			25			0,25	mA
Gate-emitter leakage current	$I_{GES}$		20	0			25			700	nA
Integrated Gate resistor	$R_{gint}$								none		$\Omega$
Turn-on delay time	$t_{d(on)}$	$R_{goff} = 4 \Omega$ $R_{gon} = 4 \Omega$	$\pm 15$	300	100		25		137		ns
Rise time	$t_r$						150		138		
Turn-off delay time	$t_{d(off)}$						25		16		
Fall time	$t_f$						150		19		
Turn-on energy loss	$E_{on}$						25		188		
Turn-off energy loss	$E_{off}$						150		217		
Input capacitance	$C_{ies}$						25		84		
Output capacitance	$C_{oss}$	150		104		6280					
Reverse transfer capacitance	$C_{rss}$	$f = 1$ MHz	0	25		25			400		pF
Gate charge	$Q_G$		$\pm 15$	480	100	25			620		nC
Thermal resistance junction to heatsink	$R_{th(j-s)}$	$\lambda_{paste} = 3,4$ W/mK (PSX)							0,44		K/W

#### Inverter Diode

Diode forward voltage	$V_F$					100	25 150		1,62 1,63	2,3	V
Peak reverse recovery current	$I_{RRM}$	$R_{goff} = 4 \Omega$	$\pm 15$	300	100		25		128		A
Reverse recovery time	$t_{rr}$						150		152		
Reverse recovered charge	$Q_{rr}$						25		106		
Peak rate of fall of recovery current	$(di_{rr}/dt)_{max}$						150		127		
Reverse recovered energy	$E_{rec}$						25		4,64		
							150		9,2		
							25		9459		
		150		5303							
Thermal resistance junction to heatsink	$R_{th(j-s)}$	$\lambda_{paste} = 3,4$ W/mK (PSX)							1,13 2,25		mWs
									0,73		K/W



### Characteristic Values

Parameter	Symbol	Conditions					Value			Unit					
		$V_{GE}$ [V]	$V_{GS}$ [V]	$V_{r}$ [V]	$V_{CE}$ [V]	$V_{DS}$ [V]	$I_C$ [A]	$I_F$ [A]	$I_D$ [A]		$T_j$ [°C]	Min	Typ	Max	
<b>Brake Switch</b>															
Gate emitter threshold voltage	$V_{GE(th)}$	$V_{CE} = V_{CE}$				0,0012	25			5	5,8	6,5	V		
Collector-emitter saturation voltage	$V_{CEsat}$		15			75	25 150				1,45 1,69	2,1	V		
Collector-emitter cut-off incl diode	$I_{CES}$		0	600			25					0,66	mA		
Gate-emitter leakage current	$I_{GES}$		20	0			25					700	nA		
Integrated Gate resistor	$R_{gint}$										none		$\Omega$		
Turn-on delay time	$t_{d(on)}$						25 150				111 113		ns		
Rise time	$t_r$						25 150				12 15				
Turn-off delay time	$t_{d(off)}$	$R_{gon} = 4 \Omega$	$\pm 15$	300	75		25 150				173 202				
Fall time	$t_f$	$R_{goff} = 4 \Omega$				25 150			53 74						
Turn-on energy loss	$E_{on}$					25 150			0,3 0,46						mWs
Turn-off energy loss	$E_{off}$					25 150			1,52 2,14						
Input capacitance	$C_{ies}$										4620		pF		
Output capacitance	$C_{oss}$	$f = 1 \text{ MHz}$	0	25		25					288				
Reverse transfer capacitance	$C_{rss}$										137				
Gate charge	$Q_G$		$\pm 15$	480	75	25					470		nC		
Thermal resistance junction to heatsink	$R_{th(j-s)}$	$\lambda_{paste} = 3,4 \text{ W/mK (PSX)}$									0,69		K/W		
<b>Brake Inverse Diode</b>															
Diode forward voltage	$V_F$					10	25 150			1,2	1,78 1,76	2,1	V		
Thermal resistance junction to heatsink	$R_{th(j-s)}$	$\lambda_{paste} = 3,4 \text{ W/mK (PSX)}$									1,74		K/W		
<b>Brake Diode</b>															
Diode forward voltage	$V_F$					30	25 150				1,62 1,58	2,1	V		
Reverse leakage current	$I_r$			300			25					140	$\mu\text{A}$		
Peak reverse recovery current	$I_{RRM}$						25 150				82 84		A		
Reverse recovery time	$t_{rr}$						25 150				22,7 116		ns		
Reverse recovered charge	$Q_{rr}$	$R_{gon} = 4 \Omega$	$\pm 15$	300	75		25 150				2,14 3,82		$\mu\text{C}$		
Peak rate of fall of recovery current	$(di_{rt}/dt)_{max}$					25 150			10578 6820						A/ $\mu\text{s}$
Reverse recovery energy	$E_{rec}$					25 150			0,52 0,97						mWs
Thermal resistance junction to heatsink	$R_{th(j-s)}$	$\lambda_{paste} = 3,4 \text{ W/mK (PSX)}$									1,42		K/W		
<b>Thermistor</b>															
Rated resistance	$R_{25}$						25			20,9	22	23,1	k $\Omega$		
Deviation of $R_{100}$	$D_{R/R}$	$R_{100} = 1486,1 \Omega$					100				2,9		%		
Power dissipation	$P$						25				210		mW		
Power dissipation constant							25				2		mW/K		



# Output Inverter

**figure 1.** IGBT

**Typical output characteristics**

$I_C = f(V_{CE})$

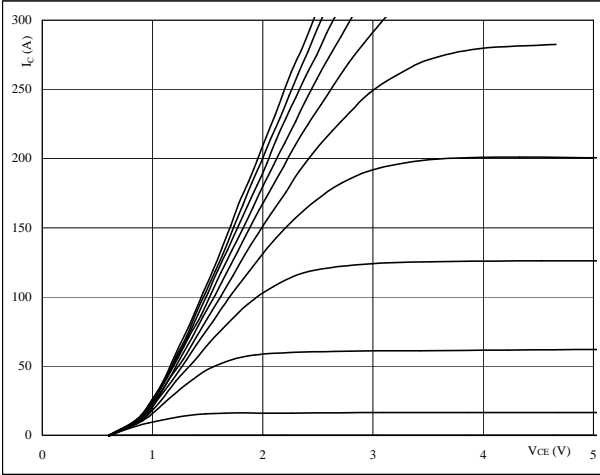

**At**

$t_p = 250 \mu s$   
 $T_j = 25 \text{ }^\circ C$   
VGE from 7 V to 17 V in steps of 1 V

**figure 2.** IGBT

**Typical output characteristics**

$I_C = f(V_{CE})$

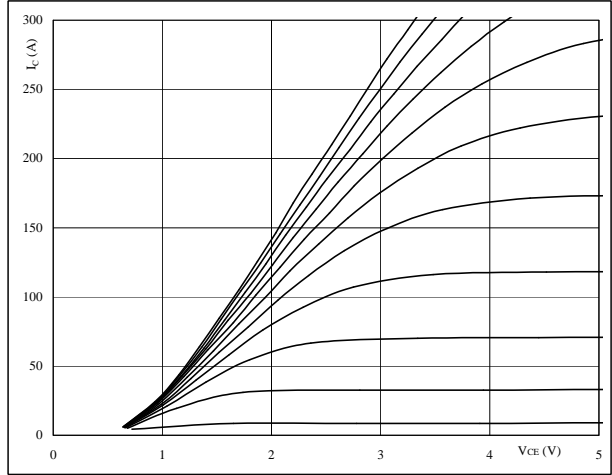

**At**

$t_p = 250 \mu s$   
 $T_j = 150 \text{ }^\circ C$   
VGE from 7 V to 17 V in steps of 1 V

**figure 3.** IGBT

**Typical transfer characteristics**

$I_C = f(V_{GE})$

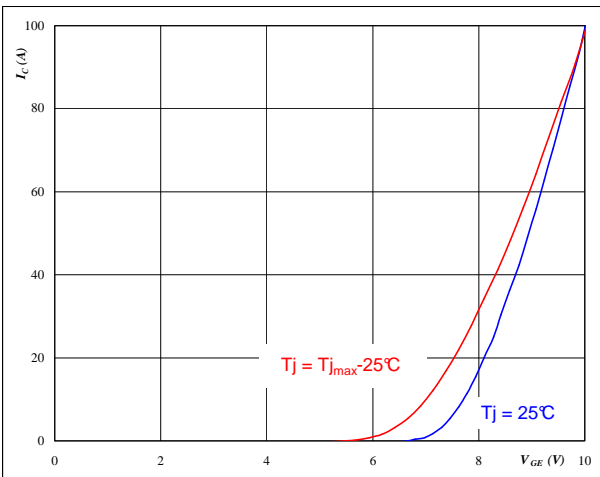

**At**

$t_p = 250 \mu s$   
 $V_{CE} = 10 V$

**figure 4.** FWD

**Typical diode forward current as a function of forward voltage**

$I_F = f(V_F)$

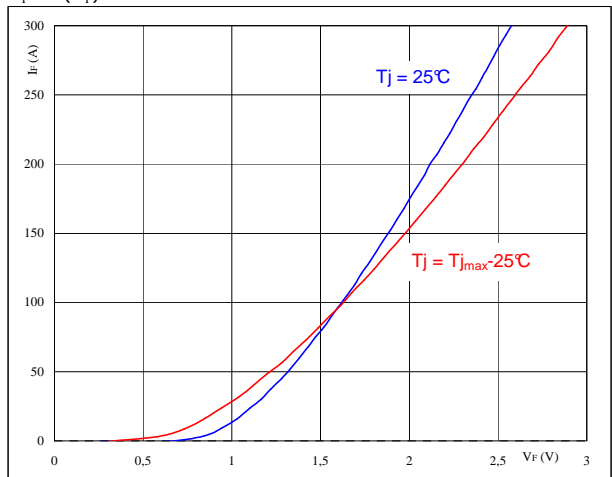

**At**

$t_p = 250 \mu s$



# Output Inverter

**figure 5.** IGBT

**Typical switching energy losses as a function of collector current**

$E = f(I_c)$

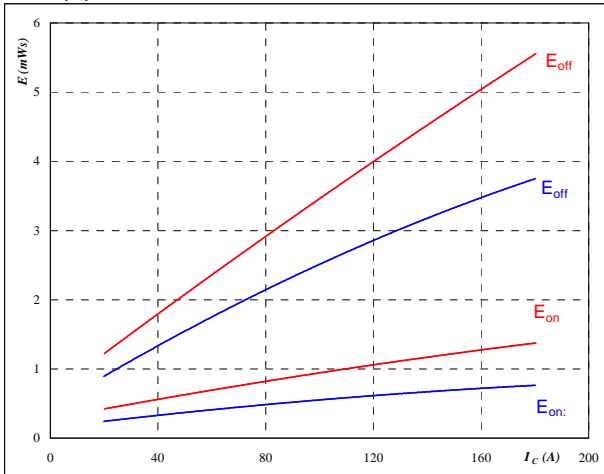

With an inductive load at

- $T_j = 25/150$  °C
- $V_{CE} = 300$  V
- $V_{GE} = \pm 15$  V
- $R_{gon} = 4$  Ω
- $R_{goff} = 4$  Ω

**figure 6.** IGBT

**Typical switching energy losses as a function of gate resistor**

$E = f(R_G)$

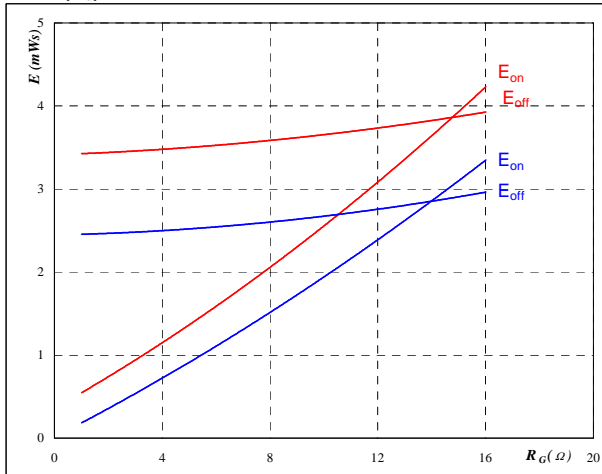

With an inductive load at

- $T_j = 25/150$  °C
- $V_{CE} = 300$  V
- $V_{GE} = \pm 15$  V
- $I_c = 100$  A

**figure 7.** IGBT

**Typical reverse recovery energy loss as a function of collector current**

$E_{rec} = f(I_c)$

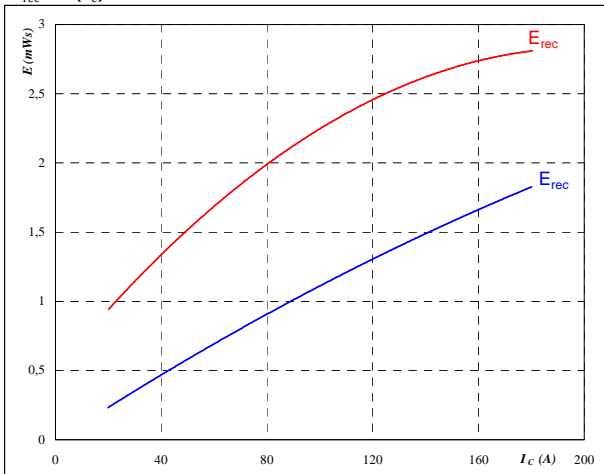

With an inductive load at

- $T_j = 25/150$  °C
- $V_{CE} = 300$  V
- $V_{GE} = \pm 15$  V
- $R_{gon} = 4$  Ω

**figure 8.** IGBT

**Typical reverse recovery energy loss as a function of gate resistor**

$E_{rec} = f(R_G)$

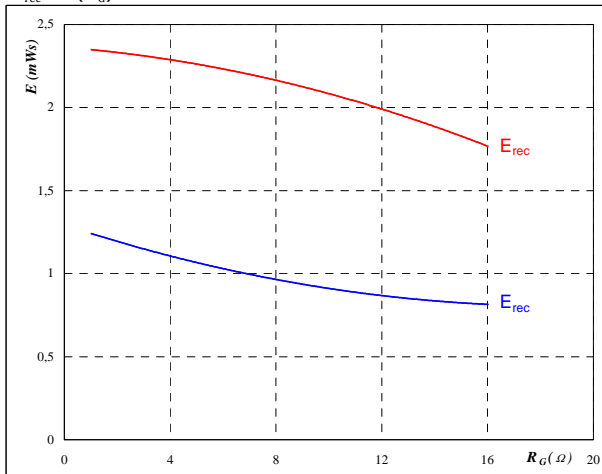

With an inductive load at

- $T_j = 25/150$  °C
- $V_{CE} = 300$  V
- $V_{GE} = \pm 15$  V
- $I_c = 100$  A



# Output Inverter

**figure 9. IGBT**

Typical switching times as a function of collector current

$t = f(I_C)$

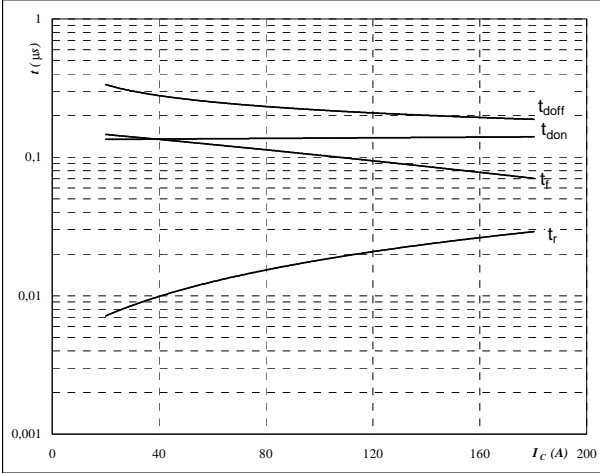

With an inductive load at

- $T_j = 150$  °C
- $V_{CE} = 300$  V
- $V_{GE} = \pm 15$  V
- $R_{gon} = 4$  Ω
- $R_{goff} = 4$  Ω

**figure 10. IGBT**

Typical switching times as a function of gate resistor

$t = f(R_G)$

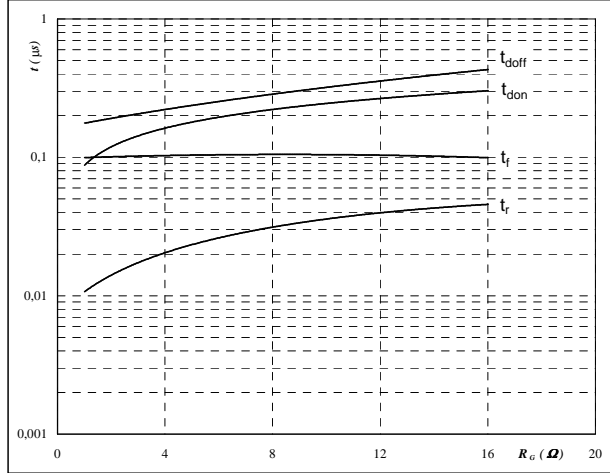

With an inductive load at

- $T_j = 150$  °C
- $V_{CE} = 300$  V
- $V_{GE} = \pm 15$  V
- $I_C = 100$  A

**figure 11. FWD**

Typical reverse recovery time as a function of collector current

$t_{rr} = f(I_C)$

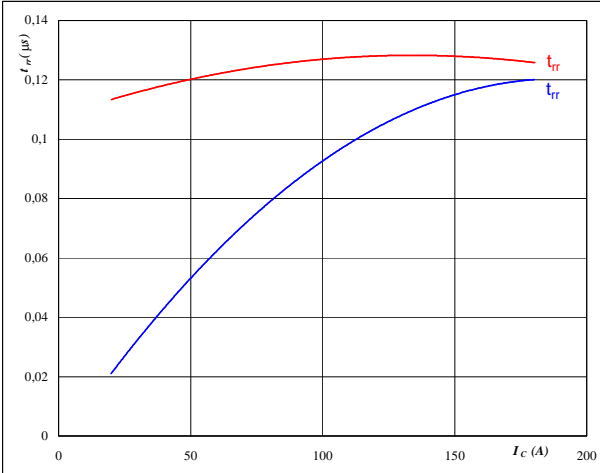

At

- $T_j = 25/150$  °C
- $V_{CE} = 300$  V
- $V_{GE} = \pm 15$  V
- $R_{gon} = 4$  Ω

**figure 12. FWD**

Typical reverse recovery time as a function of IGBT turn on gate resistor

$t_{rr} = f(R_{gon})$

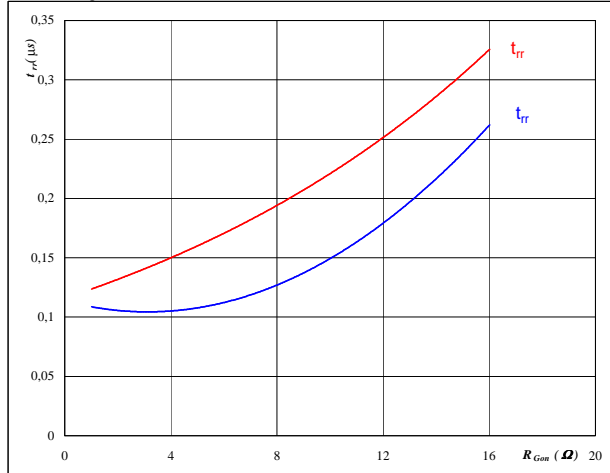

At

- $T_j = 25/150$  °C
- $V_R = 300$  V
- $I_F = 100$  A
- $V_{GE} = \pm 15$  V



# Output Inverter

figure 13. FWD

Typical reverse recovery charge as a function of collector current

$$Q_{rr} = f(I_c)$$

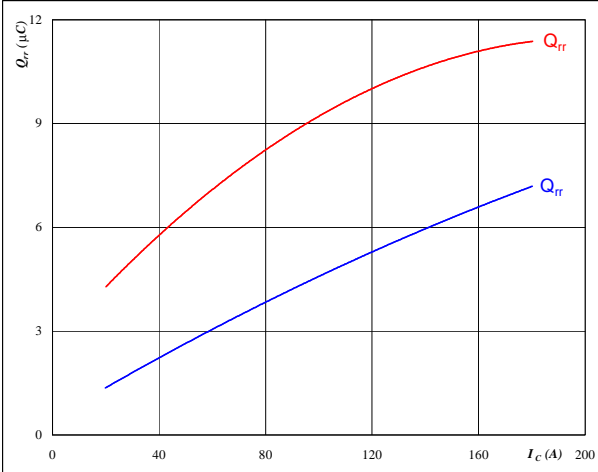

**At**  
 $T_j = 25/150$  °C  
 $V_{CE} = 300$  V  
 $V_{GE} = \pm 15$  V  
 $R_{gon} = 4$  Ω

figure 14. FWD

Typical reverse recovery charge as a function of IGBT turn on gate resistor

$$Q_{rr} = f(R_{gon})$$

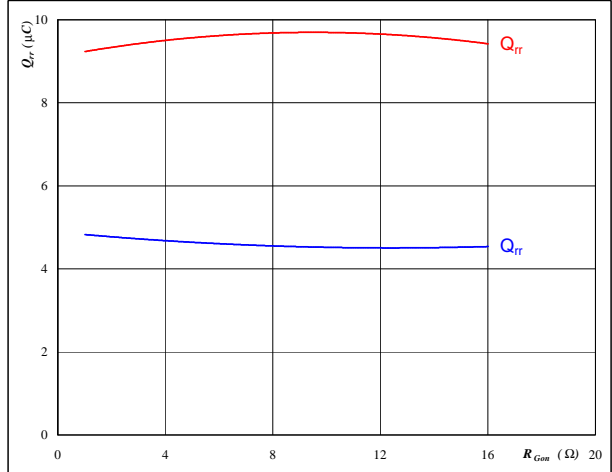

**At**  
 $T_j = 25/150$  °C  
 $V_R = 300$  V  
 $I_F = 100$  A  
 $V_{GE} = \pm 15$  V

figure 15. FWD

Typical reverse recovery current as a function of collector current

$$I_{RRM} = f(I_c)$$

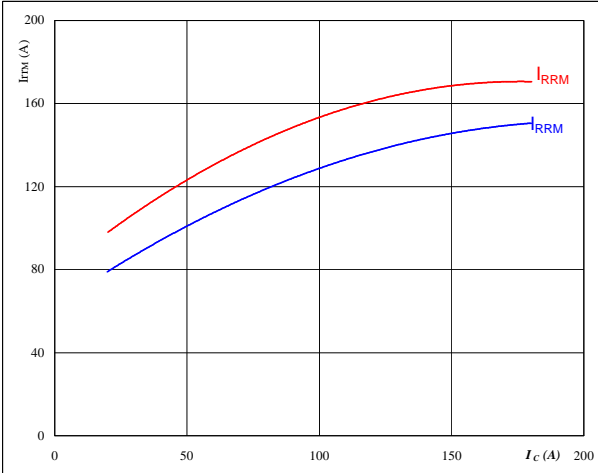

**At**  
 $T_j = 25/150$  °C  
 $V_{CE} = 300$  V  
 $V_{GE} = \pm 15$  V  
 $R_{gon} = 4$  Ω

figure 16. FWD

Typical reverse recovery current as a function of IGBT turn on gate resistor

$$I_{RRM} = f(R_{gon})$$

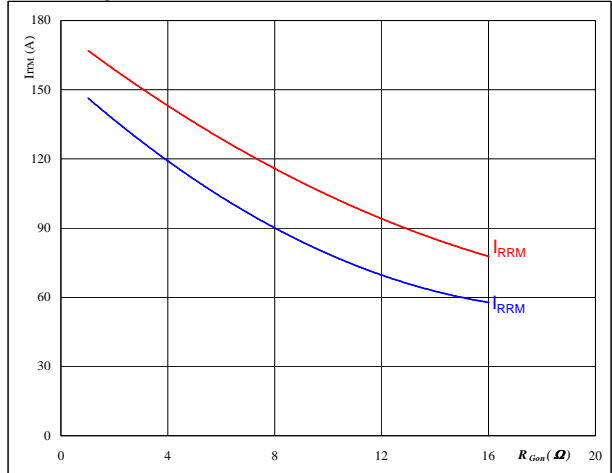

**At**  
 $T_j = 25/150$  °C  
 $V_R = 300$  V  
 $I_F = 100$  A  
 $V_{GE} = \pm 15$  V





# Output Inverter

**figure 17.** FWD

Typical rate of fall of forward and reverse recovery current as a function of collector current

$$dI_0/dt, dI_{rec}/dt = f(I_c)$$

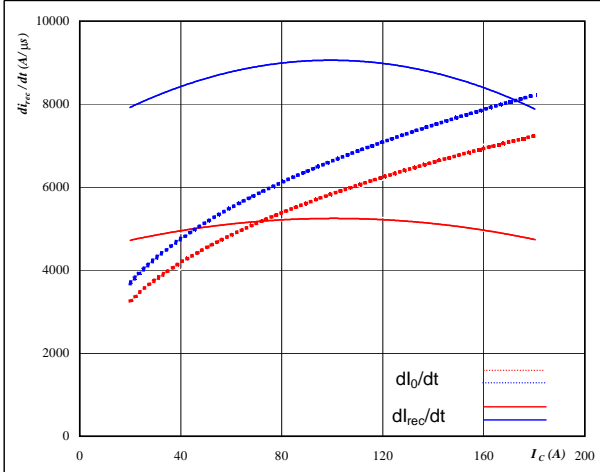

**At**  
 $T_j = 25/150$  °C  
 $V_{CE} = 300$  V  
 $V_{GE} = \pm 15$  V  
 $R_{gon} = 4$  Ω

**figure 18.** FWD

Typical rate of fall of forward and reverse recovery current as a function of IGBT turn on gate resistor

$$dI_0/dt, dI_{rec}/dt = f(R_{gon})$$

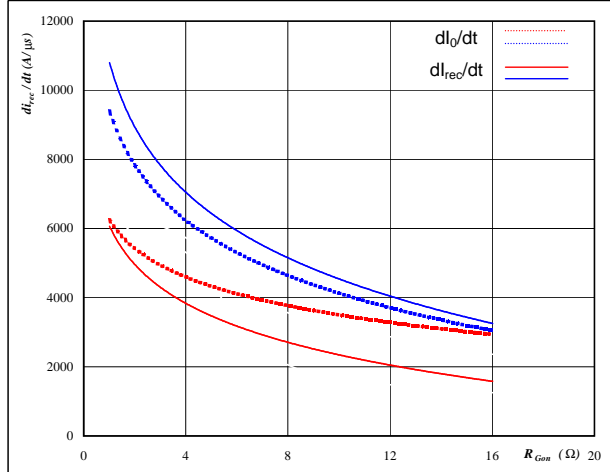

**At**  
 $T_j = 25/150$  °C  
 $V_R = 300$  V  
 $I_F = 100$  A  
 $V_{GE} = \pm 15$  V

**figure 19.** IGBT

IGBT transient thermal impedance as a function of pulse width

$$Z_{th(j-s)} = f(t_p)$$

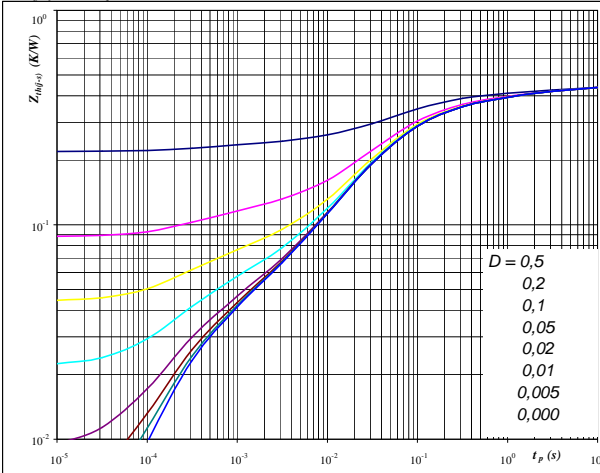

**At**  
 $D = t_p / T$   
 $R_{th(j-s)} = 0,44$  K/W  
 Single device heated  
 IGBT thermal model values

R (K/W)	Tau (s)
5,33E-02	3,13E+00
6,35E-02	4,55E-01
1,49E-01	8,61E-02
1,20E-01	2,32E-02
2,69E-02	2,62E-03
2,67E-02	2,83E-04

**figure 20.** FWD

FWD transient thermal impedance as a function of pulse width

$$Z_{th(j-s)} = f(t_p)$$

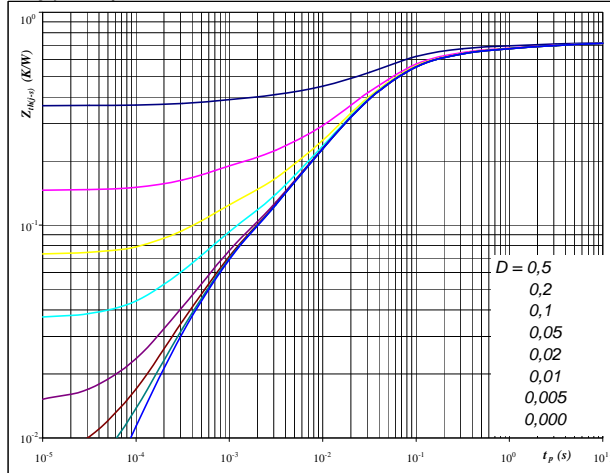

**At**  
 $D = t_p / T$   
 $R_{th(j-s)} = 0,73$  K/W  
 Single device heated  
 FWD thermal model values

R (K/W)	Tau (s)
4,08E-02	9,16E+00
5,69E-02	8,67E-01
1,69E-01	1,19E-01
3,37E-01	2,86E-02
7,44E-02	4,99E-03
5,00E-02	5,33E-04



# Output Inverter

**figure 21.** IGBT

**Power dissipation as a function of heatsink temperature**

$$P_{tot} = f(T_s)$$

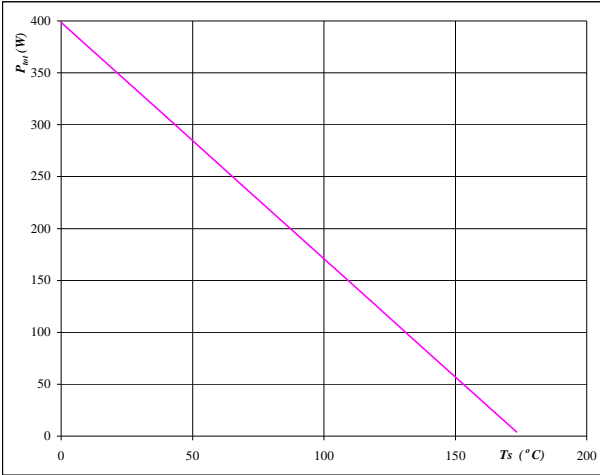

**At**  
T<sub>j</sub> = 175 °C

**figure 22.** IGBT

**Collector current as a function of heatsink temperature**

$$I_C = f(T_s)$$

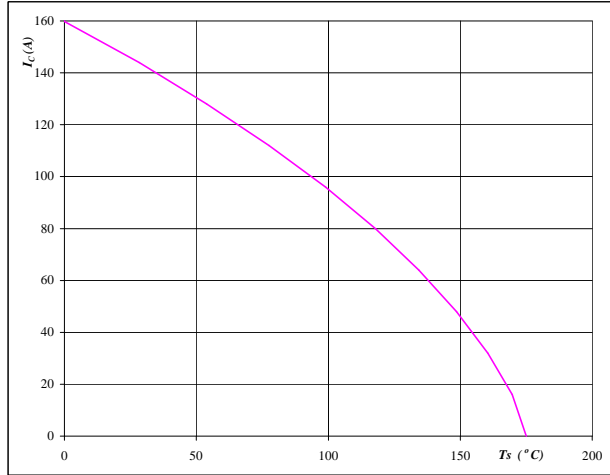

**At**  
T<sub>j</sub> = 175 °C  
V<sub>GE</sub> = 15 V

**figure 23.** FWD

**Power dissipation as a function of heatsink temperature**

$$P_{tot} = f(T_s)$$

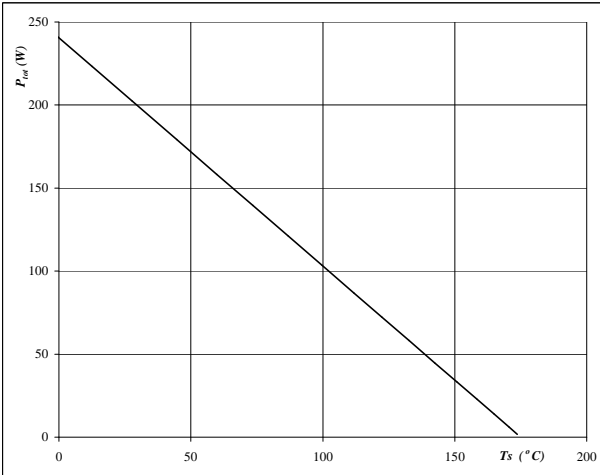

**At**  
T<sub>j</sub> = 175 °C

**figure 24.** FWD

**Forward current as a function of heatsink temperature**

$$I_F = f(T_s)$$

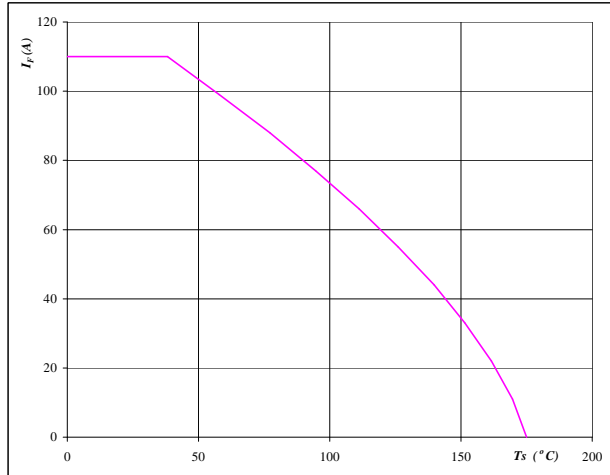

**At**  
T<sub>j</sub> = 175 °C



# Output Inverter

**figure 25.** IGBT

**Safe operating area as a function of collector-emitter voltage**

$I_C = f(V_{CE})$

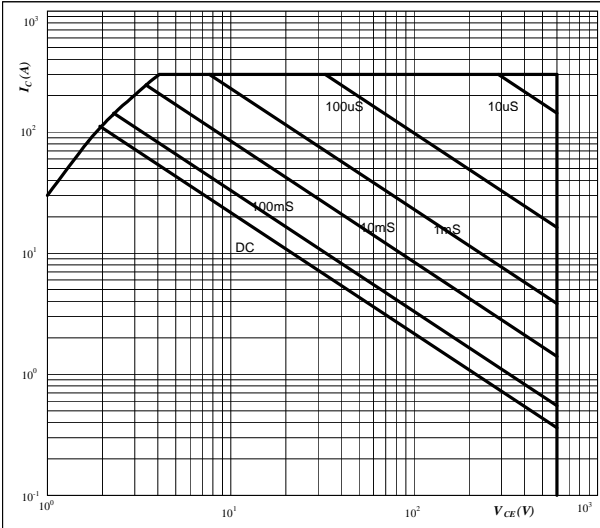

**At**  
 $D =$  single pulse  
 $T_s = 80$  °C  
 $V_{GE} = \pm 15$  V  
 $T_j = T_{jmax}$

**figure 26.** IGBT

**Gate voltage vs Gate charge**

$V_{GE} = f(Q_g)$

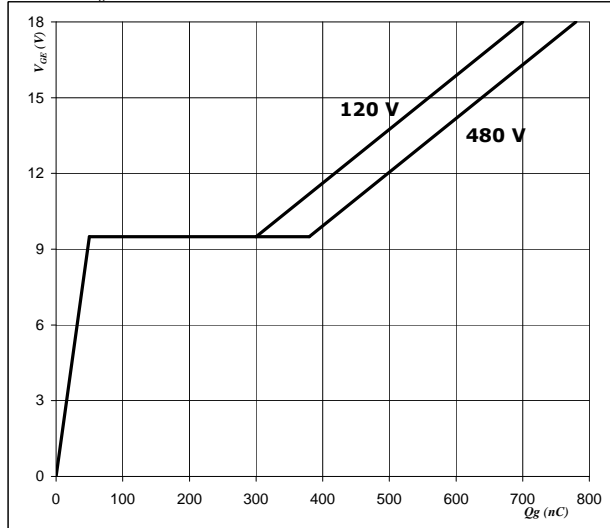

**At**  
 $I_C = 100$  A



# Brake

**figure 1. IGBT**

**Typical output characteristics**

$I_C = f(V_{CE})$

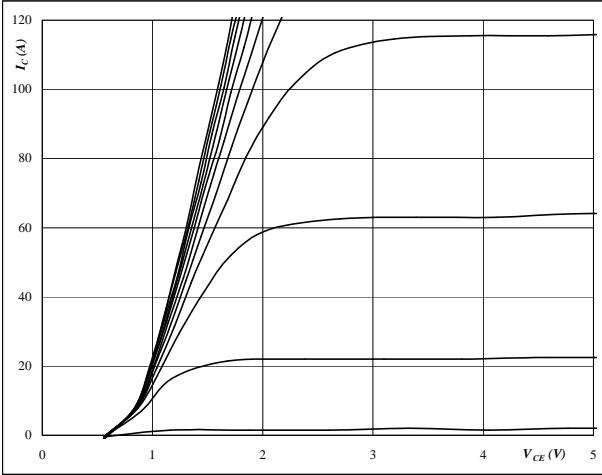

**At**

$t_p = 250 \mu s$   
 $T_j = 25 \text{ } ^\circ C$   
VGE from 7 V to 17 V in steps of 1 V

**figure 2. IGBT**

**Typical output characteristics**

$I_C = f(V_{CE})$

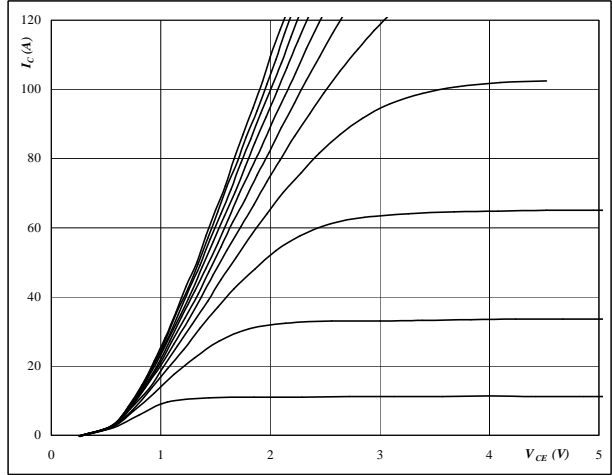

**At**

$t_p = 250 \mu s$   
 $T_j = 150 \text{ } ^\circ C$   
VGE from 7 V to 17 V in steps of 1 V

**figure 3. IGBT**

**Typical transfer characteristics**

$I_C = f(V_{GE})$

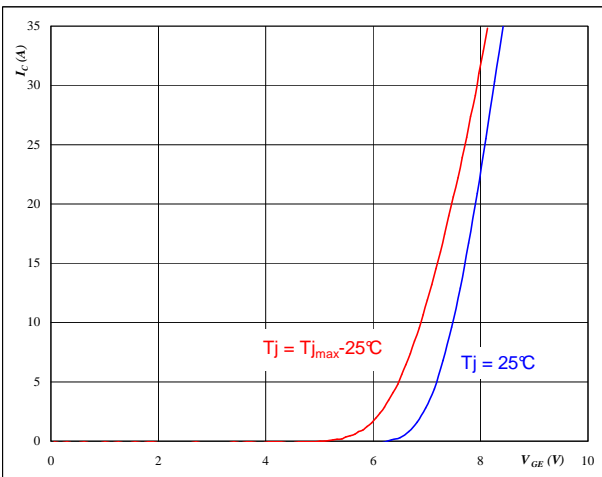

**At**

$t_p = 250 \mu s$   
 $V_{CE} = 10 V$

**figure 4. FWD**

**Typical diode forward current as a function of forward voltage**

$I_F = f(V_F)$

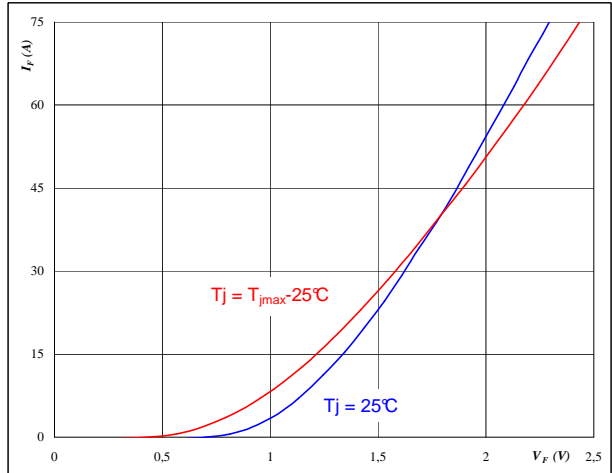

**At**

$t_p = 250 \mu s$



# Brake

**figure 5.** IGBT

**Typical switching energy losses as a function of collector current**

$E = f(I_C)$

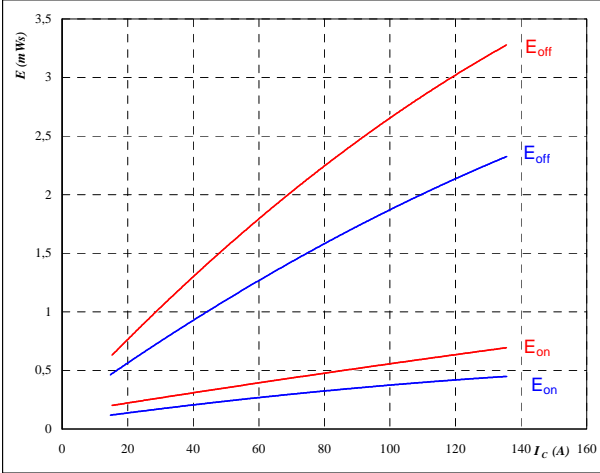

With an inductive load at

- $T_j = 25/150$  °C
- $V_{CE} = 300$  V
- $V_{GE} = \pm 15$  V
- $R_{gon} = 4$  Ω
- $R_{goff} = 4$  Ω

**figure 6.** IGBT

**Typical switching energy losses as a function of gate resistor**

$E = f(R_G)$

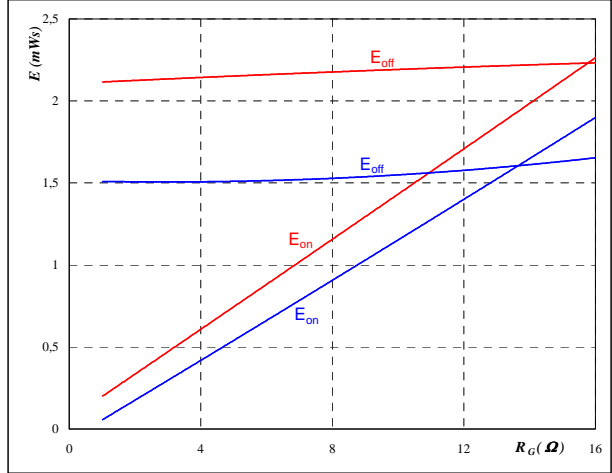

With an inductive load at

- $T_j = 25/150$  °C
- $V_{CE} = 300$  V
- $V_{GE} = \pm 15$  V
- $I_C = 75$  A

**figure 7.** IGBT

**Typical reverse recovery energy loss as a function of collector current**

$E_{rec} = f(I_C)$

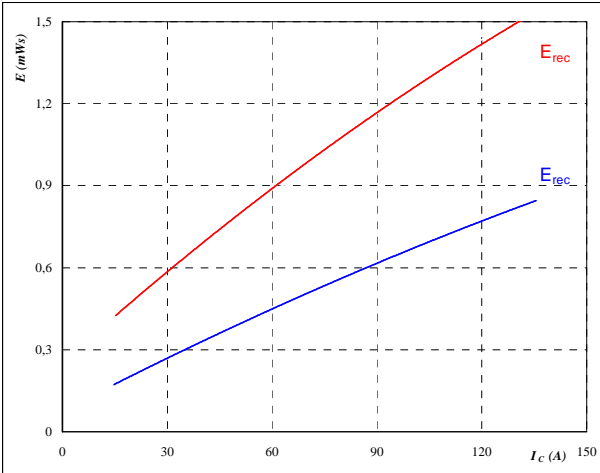

With an inductive load at

- $T_j = 25/150$  °C
- $V_{CE} = 300$  V
- $V_{GE} = \pm 15$  V
- $R_{gon} = 4$  Ω

**figure 8.** IGBT

**Typical reverse recovery energy loss as a function of gate resistor**

$E_{rec} = f(R_G)$

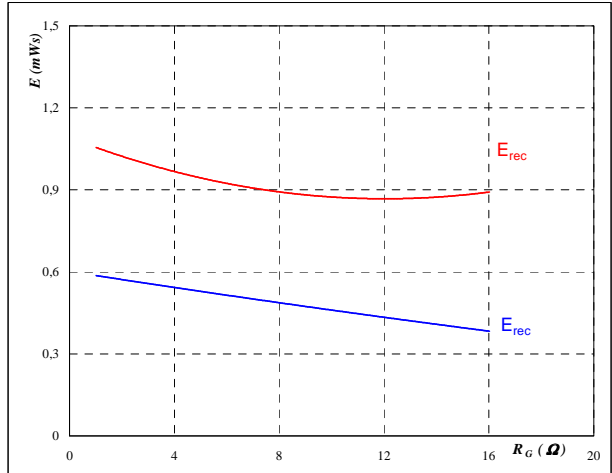

With an inductive load at

- $T_j = 25/150$  °C
- $V_{CE} = 300$  V
- $V_{GE} = \pm 15$  V
- $I_C = 75$  A



# Brake

**figure 9. IGBT**  
Typical switching times as a function of collector current

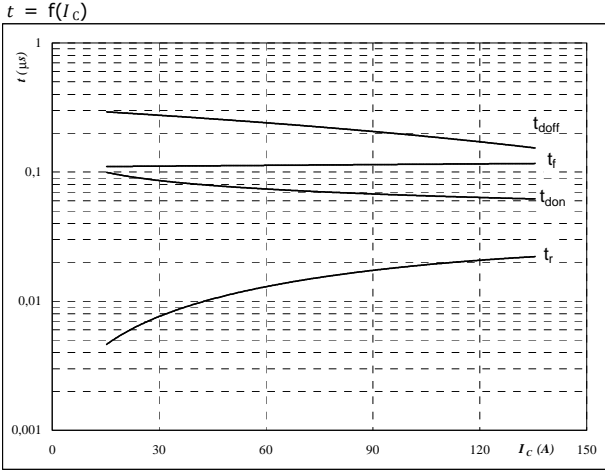

With an inductive load at  
 $T_j = 150 \text{ } ^\circ\text{C}$   
 $V_{CE} = 300 \text{ V}$   
 $V_{GE} = \pm 15 \text{ V}$   
 $R_{gon} = 4 \text{ } \Omega$   
 $R_{goff} = 4 \text{ } \Omega$

**figure 10. IGBT**  
Typical switching times as a function of gate resistor

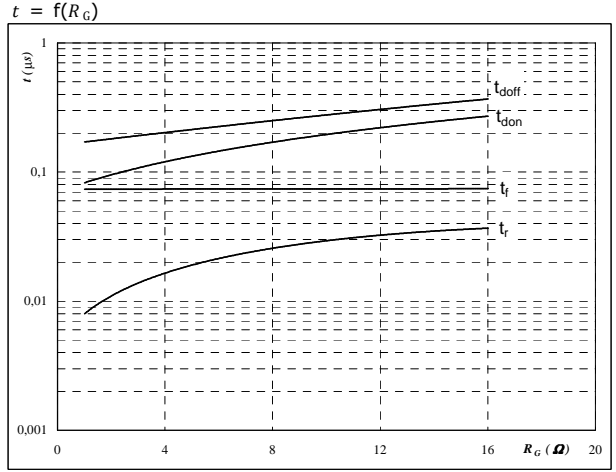

With an inductive load at  
 $T_j = 150 \text{ } ^\circ\text{C}$   
 $V_{CE} = 300 \text{ V}$   
 $V_{GE} = \pm 15 \text{ V}$   
 $I_C = 75 \text{ A}$

**figure 11. IGBT**  
IGBT transient thermal impedance as a function of pulse width

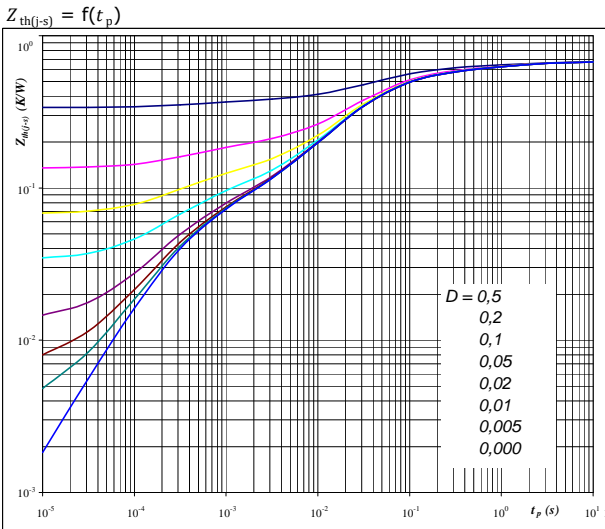

**At**  
 $D = t_p / T$   
 $R_{th(i-s)} = 0,67 \text{ K/W}$

**figure 12. IGBT**  
FWD transient thermal impedance as a function of pulse width

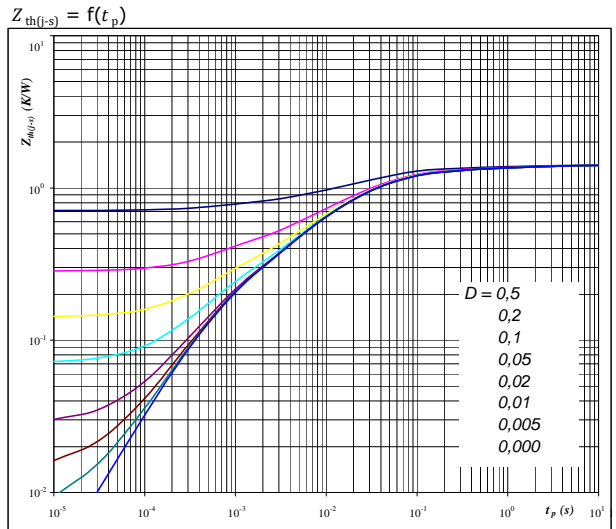

**At**  
 $D = t_p / T$   
 $R_{th(f-s)} = 1,42 \text{ K/W}$



# Brake

**figure 13.** IGBT

**Power dissipation as a function of heatsink temperature**

$$P_{tot} = f(T_s)$$

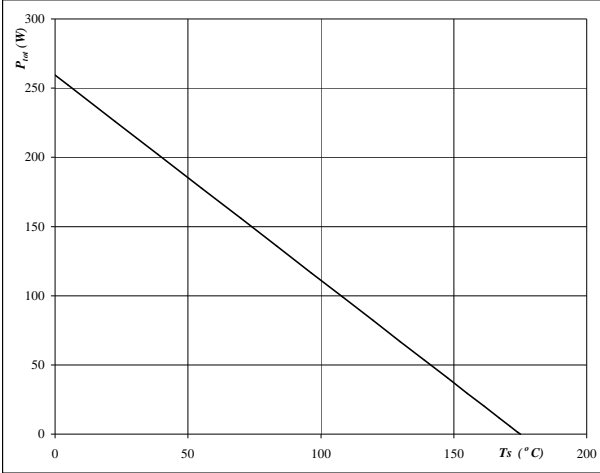

**At**  
T<sub>j</sub> = 175 °C

**figure 14.** IGBT

**Collector current as a function of heatsink temperature**

$$I_C = f(T_s)$$

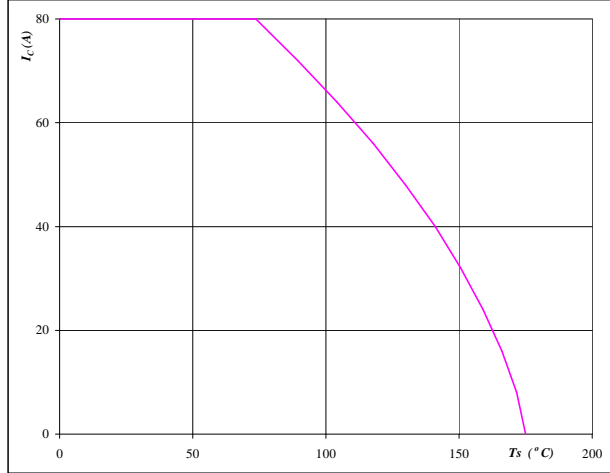

**At**  
T<sub>j</sub> = 175 °C  
V<sub>GE</sub> = 15 V

**figure 15.** FWD

**Power dissipation as a function of heatsink temperature**

$$P_{tot} = f(T_s)$$

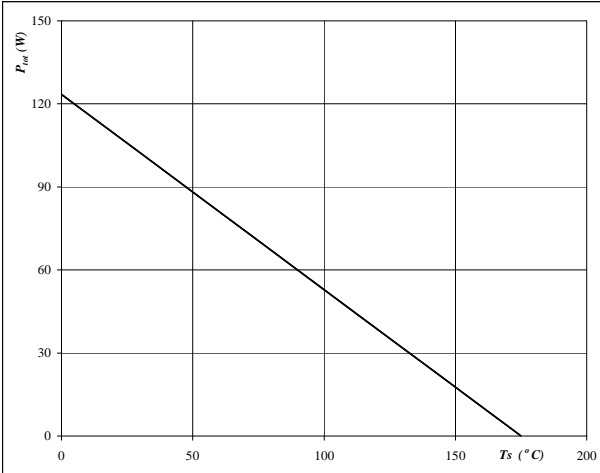

**At**  
T<sub>j</sub> = 175 °C

**figure 16.** FWD

**Forward current as a function of heatsink temperature**

$$I_F = f(T_s)$$

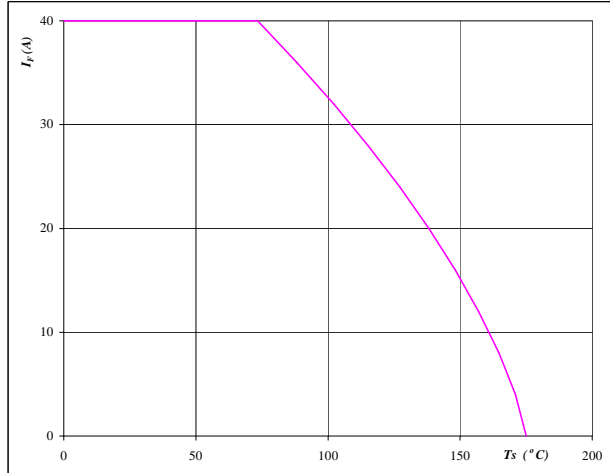

**At**  
T<sub>j</sub> = 175 °C



# Brake Inverse Diode

**figure 1. Brake inverse diode**

Typical diode forward current as a function of forward voltage

$$I_F = f(V_F)$$

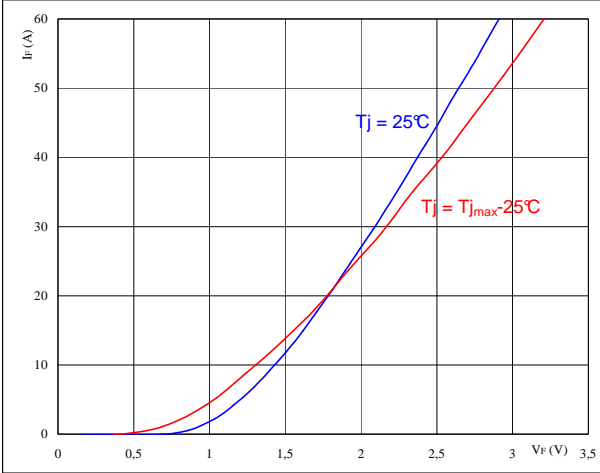

At

$$t_p = 250 \mu s$$

**figure 2. Brake inverse diode**

Diode transient thermal impedance as a function of pulse width

$$Z_{th(j-s)} = f(t_p)$$

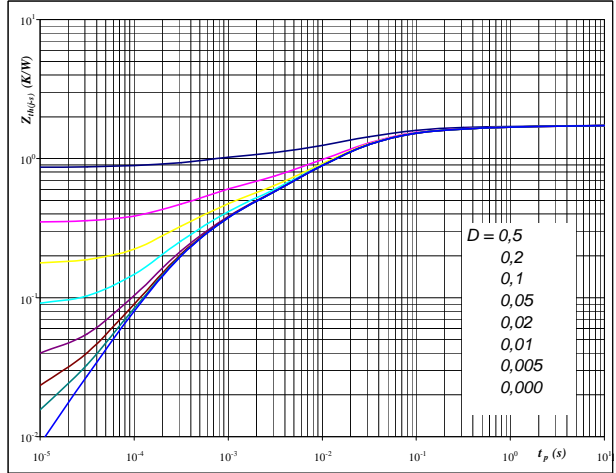

At

$$D = t_p / T$$

$$R_{th(j-s)} = 1,74 \text{ K/W}$$

**figure 3. Brake inverse diode**

Power dissipation as a function of heatsink temperature

$$P_{tot} = f(T_s)$$

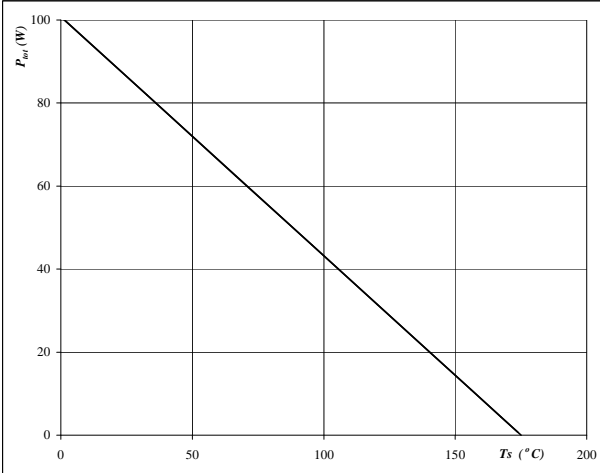

At

$$T_j = 175 \text{ } ^\circ\text{C}$$

**figure 4. Brake inverse diode**

Forward current as a function of heatsink temperature

$$I_F = f(T_s)$$

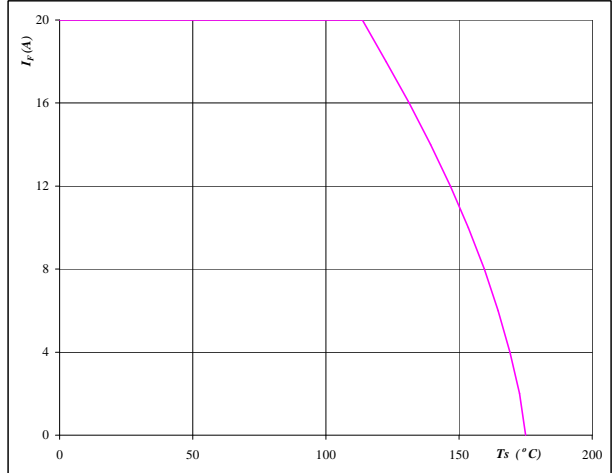

At

$$T_j = 175 \text{ } ^\circ\text{C}$$





# Input Rectifier Bridge

**figure 1. Rectifier Diode**

Typical diode forward current as a function of forward voltage

$I_F = f(V_F)$

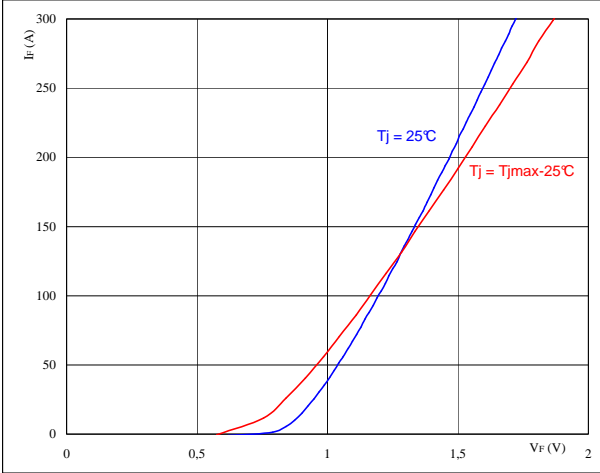

**At**  
 $t_p = 250 \mu s$

**figure 2. Rectifier Diode**

Diode transient thermal impedance as a function of pulse width

$Z_{th(j-s)} = f(t_p)$

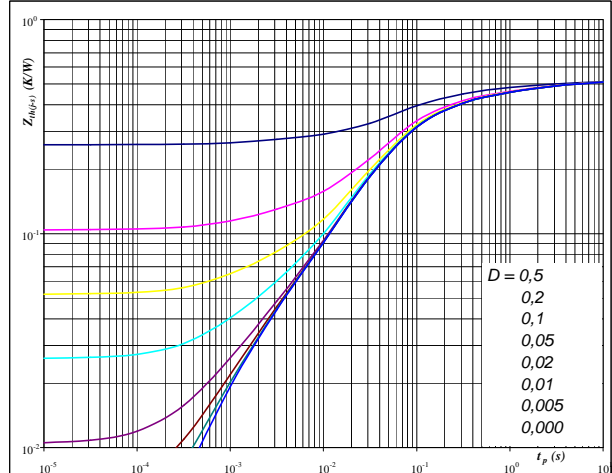

**At**  
 $D = t_p / T$   
 $R_{th(j-s)} = 0,52 \text{ K/W}$

**figure 3. Rectifier Diode**

Power dissipation as a function of heatsink temperature

$P_{tot} = f(T_s)$

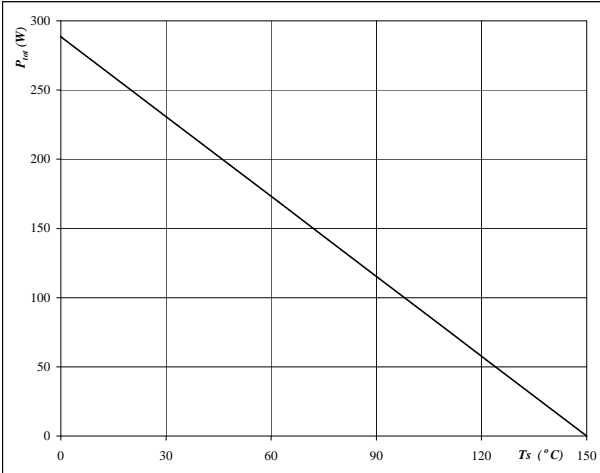

**At**  
 $T_j = 150 \text{ °C}$

**figure 4. Rectifier Diode**

Forward current as a function of heatsink temperature

$I_F = f(T_s)$

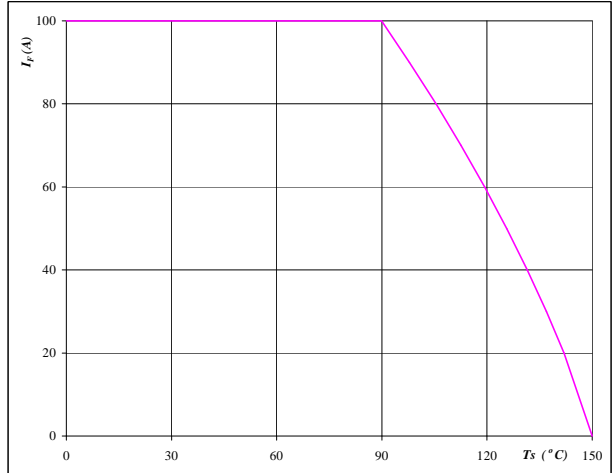

**At**  
 $T_j = 150 \text{ °C}$



# Thermistor

**figure 1. Thermistor**

**Typical NTC characteristic  
as a function of temperature**

$$R_T = f(T)$$

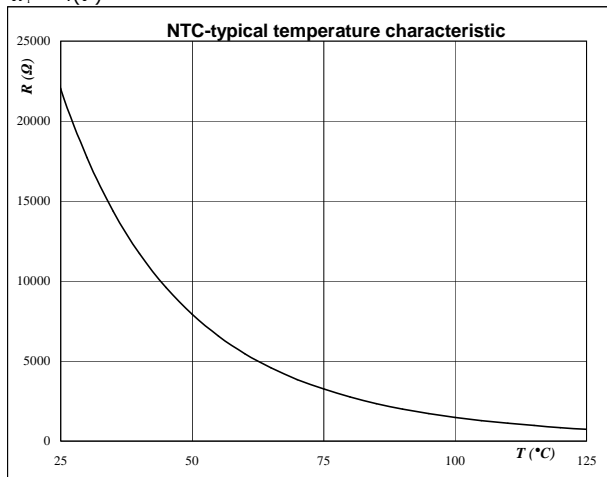



# Switching Definitions Output Inverter

**General conditions**

$T_j$	=	150 °C
$R_{gon}$	=	4 Ω
$R_{goff}$	=	4 Ω

**figure 1. IGBT**

**Turn-off Switching Waveforms & definition of  $t_{doff}$ ,  $t_{Eoff}$**   
( $t_{Eoff}$  = integrating time for  $E_{off}$ )

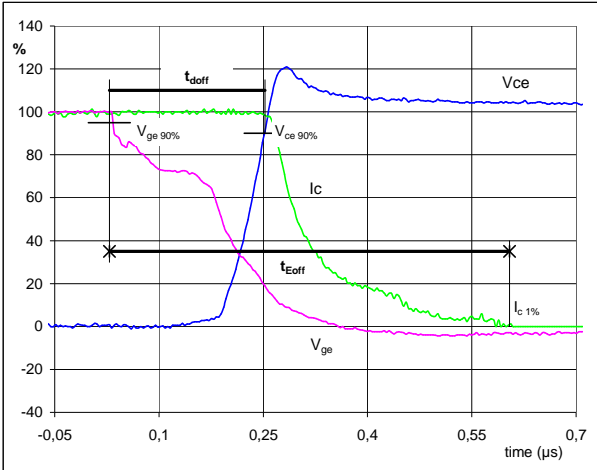

$V_{GE}$ (0%) =	-15	V
$V_{GE}$ (100%) =	15	V
$V_C$ (100%) =	300	V
$I_C$ (100%) =	100	A
$t_{doff}$ =	0,22	μs
$t_{Eoff}$ =	0,58	μs

**figure 2. IGBT**

**Turn-on Switching Waveforms & definition of  $t_{don}$ ,  $t_{Eon}$**   
( $t_{Eon}$  = integrating time for  $E_{on}$ )

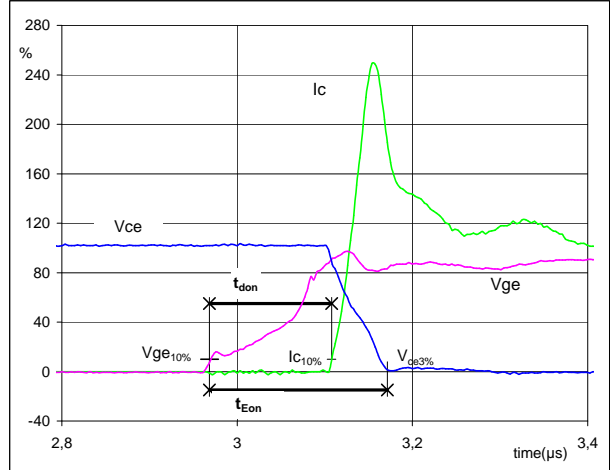

$V_{GE}$ (0%) =	-15	V
$V_{GE}$ (100%) =	15	V
$V_C$ (100%) =	300	V
$I_C$ (100%) =	100	A
$t_{don}$ =	0,14	μs
$t_{Eon}$ =	0,20	μs

**figure 3. IGBT**

**Turn-off Switching Waveforms & definition of  $t_f$**

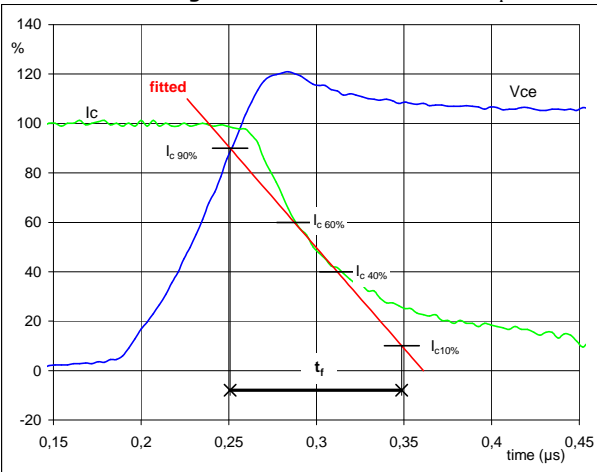

$V_C$ (100%) =	300	V
$I_C$ (100%) =	100	A
$t_f$ =	0,10	μs

**figure 4. IGBT**

**Turn-on Switching Waveforms & definition of  $t_r$**

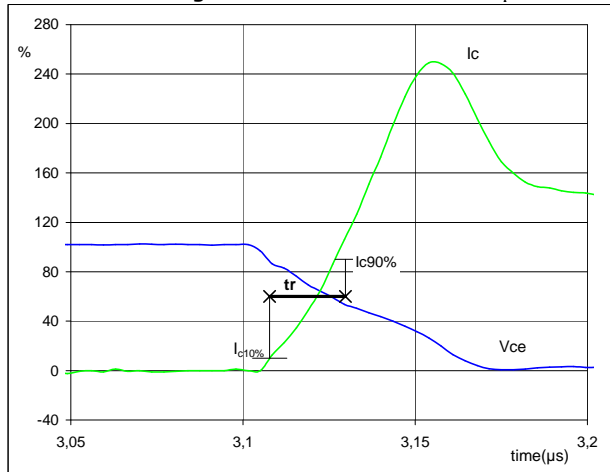

$V_C$ (100%) =	300	V
$I_C$ (100%) =	100	A
$t_r$ =	0,02	μs



# Switching Definitions Output Inverter

**figure 5. IGBT**  
**Turn-off Switching Waveforms & definition of  $t_{Eoff}$**

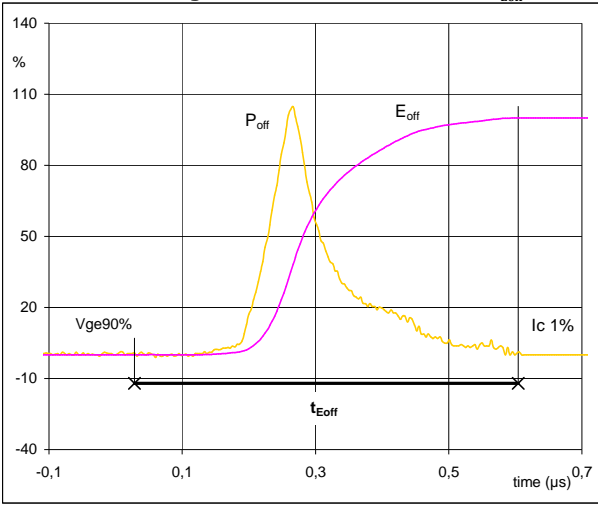

$P_{off} (100\%) = 30,01 \text{ kW}$   
 $E_{off} (100\%) = 3,48 \text{ mJ}$   
 $t_{Eoff} = 0,58 \text{ µs}$

**figure 6. IGBT**  
**Turn-on Switching Waveforms & definition of  $t_{Eon}$**

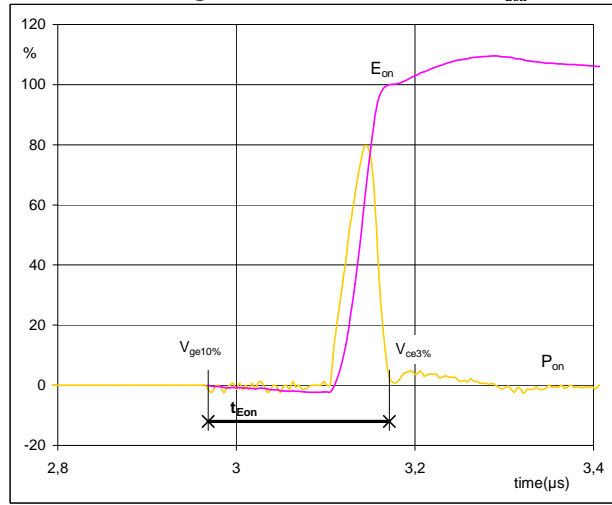

$P_{on} (100\%) = 30,01 \text{ kW}$   
 $E_{on} (100\%) = 0,93 \text{ mJ}$   
 $t_{Eon} = 0,20 \text{ µs}$

**figure 7. FWD**  
**Turn-off Switching Waveforms & definition of  $t_{tr}$**

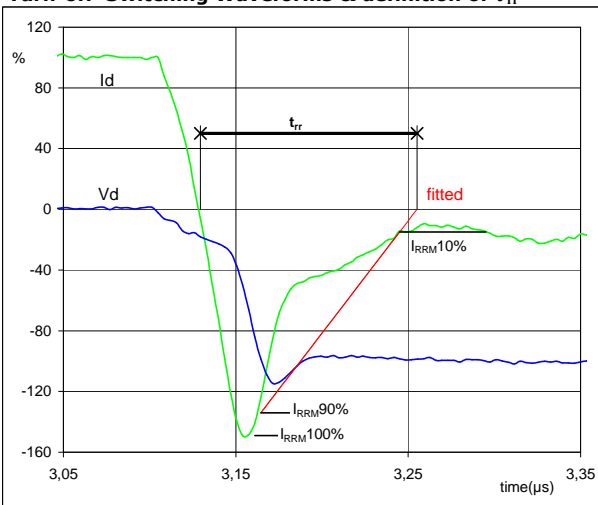

$V_d (100\%) = 300 \text{ V}$   
 $I_d (100\%) = 100 \text{ A}$   
 $I_{RRM} (100\%) = -152 \text{ A}$   
 $t_{tr} = 0,13 \text{ µs}$



## Switching Definitions Output Inverter

**figure 8. FWD**

**Turn-on Switching Waveforms & definition of  $t_{Qrr}$**   
 ( $t_{Qrr}$  = integrating time for  $Q_{rr}$ )

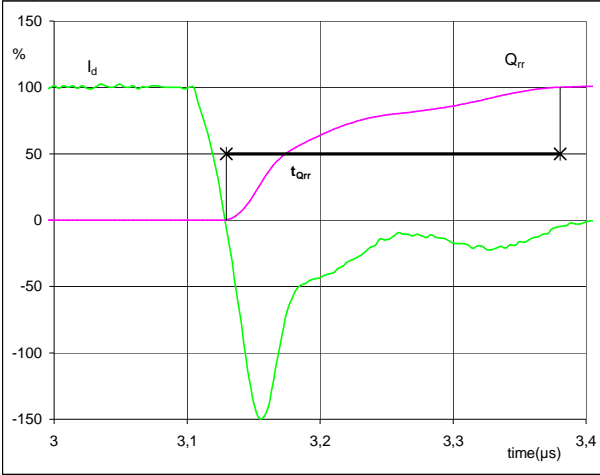

$I_d$ (100%) =	100	A
$Q_{rr}$ (100%) =	9,20	$\mu\text{C}$
$t_{Qint}$ =	0,25	$\mu\text{s}$

**figure 9. FWD**

**Turn-on Switching Waveforms & definition of  $t_{Erec}$**   
 ( $t_{Erec}$  = integrating time for  $E_{rec}$ )

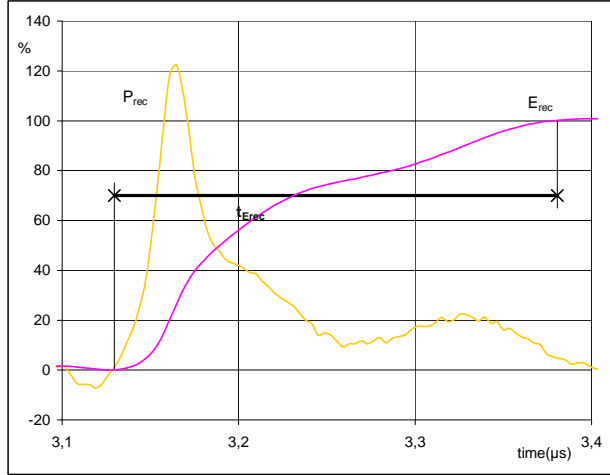

$P_{rec}$ (100%) =	30,01	kW
$E_{rec}$ (100%) =	2,25	mJ
$t_{Erec}$ =	0,25	$\mu\text{s}$



## Ordering Code and Marking - Outline - Pinout

Ordering Code & Marking				
Version	Ordering Code	in DataMatrix as	in packaging barcode as	
without thermal paste with solder pins	V23990-P765-A-PM	P765-A	P765-A	
with thermal paste with solder pins	V23990-P765-A-/3-PM	P765-A-/3/	P765-A-/3/	
without thermal paste with Press-fit pins	V23990-P765-AY-PM	P765-AY	P765-AY	
with thermal paste with Press-fit pins	V23990-P765-AY-/3-PM	P765-AY-/3/	P765-AY-/3/	

	Name		Date code	UL & Vinco	Lot	Serial
	Text	NN-NNNNNNNNNNNN-TTTTTTVV	WWYY	UL Vinco	LLLL	SSSS
Datamatrix	Type&Ver	Lot number	Serial	Date code		
	TTTTTTTVV	LLLL	SSSS	WWYY		

Pin table [mm]								Pin table [mm]								Outline	
Pin	Func	X	Y	Pin	Func	X	Y	Pin	Func	X	Y	Pin	Func	X	Y		
1	DC-	71,2	0	29	U	0	37,2										
2	DC-	68,7	0	30	U	2,5	37,2										
3	DC-	66,2	0	31	U	5	37,2										
4	DC-	63,7	0	32	E	7,8	37,2										
5	DC+	55,95	0	33	G	10,6	37,2										
6	DC+	53,45	0	34	G	18,45	37,2										
7	DC+	55,95	2,8	35	E	21,25	37,2										
8	DC+	53,45	2,8	36	V	24,05	37,2										
9	DC+	48,4	0	37	V	26,55	37,2										
10	DC+	45,9	0	38	V	29,05	37,2										
11	E	38,9	0	39	W	36,1	37,2										
12	DC-	36,1	0	40	W	38,6	37,2										
13	G	38,9	2,8	41	W	41,1	37,2										
14	DC-	36,1	2,8	42	E	43,9	37,2										
15	DC-	31,3	0	43	G	46,7	37,2										
16	E	28,5	0	44	L1	53,7	37,2										
17	DC-	31,3	2,8	45	L1	56,2	37,2										
18	G	28,5	2,8	46	L1	58,7	37,2										
19	R2	19,3	0	47	L2	71,2	37,2										
20	R1	19,3	2,8	48	L2	71,2	34,7										
21	DC+	12,3	0	49	L2	71,2	32,2										
22	DC+	9,8	0	50	L3	71,2	25,2										
23	DC+	12,3	2,8	51	L3	71,2	22,7										
24	DC+	9,8	2,8	52	L3	71,2	20,2										
25	E	2,8	0	53	BrC	71,2	12,8										
26	DC-	0	0	54	BrC	68,7	12,8										
27	G	2,8	2,8	55	BrG	71,2	5,6										
28	DC-	0	2,8	56	BrE	71,2	2,8										

center of press-fit pinhead  
for connection parameter see the handling instruction

Tolerance of positions: ±0.5mm at the end of pins  
Dimension of coordinate axis is only arbel without tolerance

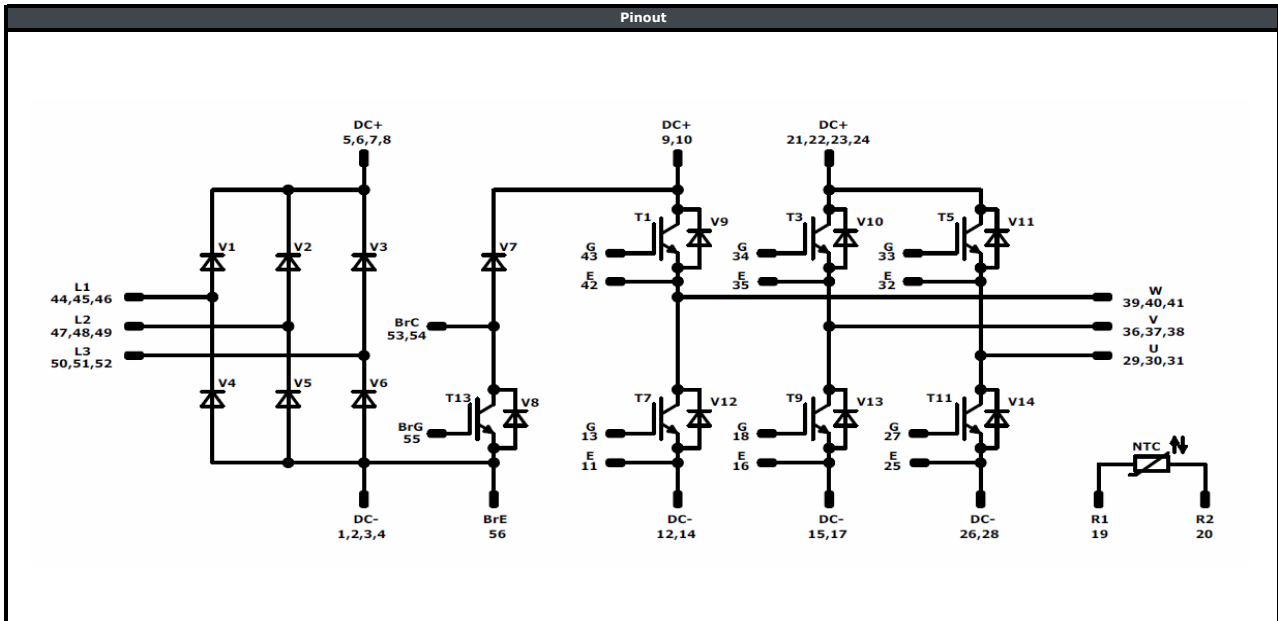

Identification					
ID	Component	Voltage	Current	Function	Comment
T1,T3,T5,T7,T9,T11	IGBT	600 V	100 A	Inverter Switch	
V9-V14	FWD	600 V	50 A	Inverter Diode	
V1-V6	Rectifier Diode	1600 V	75 A	Rectifier Diode	
T13	IGBT	600 V	75A	Brake Switch	
V7	FWD	600 V	30 A	Brake Diode	
V8	FWD	600 V	20 A	Brake Inverse Diode	
NTC	Thermistor			Thermistor	



Packaging instruction			
Standard packaging quantity (SPQ)	36	>SPQ Standard	<SPQ Sample

Handling instruction
Handling instructions for <i>flow 2</i> packages see vincotech.com website.

Package data
Package data for <i>flow 2</i> packages see vincotech.com website.

UL recognition and file number
This device is certified according to UL 1557 standard, UL file number E192116. For more information see vincotech.com website. 

Document No.:	Date:	Modification:	Pages
V23990-P765-Ax-D7-14	18 Dec. 2017	Updated Rth with phase change material	

**DISCLAIMER**

The information, specifications, procedures, methods and recommendations herein (together "information") are presented by Vincotech to reader in good faith, are believed to be accurate and reliable, but may well be incomplete and/or not applicable to all conditions or situations that may exist or occur. Vincotech reserves the right to make any changes without further notice to any products to improve reliability, function or design. No representation, guarantee or warranty is made to reader as to the accuracy, reliability or completeness of said information or that the application or use of any of the same will avoid hazards, accidents, losses, damages or injury of any kind to persons or property or that the same will not infringe third parties rights or give desired results. It is reader's sole responsibility to test and determine the suitability of the information and the product for reader's intended use.

**LIFE SUPPORT POLICY**

Vincotech products are not authorised for use as critical components in life support devices or systems without the express written approval of Vincotech.

As used herein:

1. Life support devices or systems are devices or systems which, (a) are intended for surgical implant into the body, or (b) support or sustain life, or (c) whose failure to perform when properly used in accordance with instructions for use provided in labelling can be reasonably expected to result in significant injury to the user.
2. A critical component is any component of a life support device or system whose failure to perform can be reasonably expected to cause the failure of the life support device or system, or to affect its safety or effectiveness.