

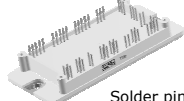



<i>flow PIM 2</i>	600 V / 75 A
<div style="background-color: #eee; padding: 2px; margin-bottom: 5px;">Features</div> <ul style="list-style-type: none"> Three-phase rectifier, BRC, Inverter, NTC Very Compact housing, easy to route IGBT3/ EmCon3 technology for low saturation losses and improved EMC behavior 	<div style="background-color: #eee; padding: 2px; margin-bottom: 5px;">flow 2 17mm housing</div> <div style="display: flex; justify-content: space-around;"> <div style="text-align: center;">  Solder pins </div> <div style="text-align: center;">  Press-fit pins </div> </div>
<div style="background-color: #eee; padding: 2px; margin-bottom: 5px;">Target Applications</div> <ul style="list-style-type: none"> Motor Drives Power Generation 	<div style="background-color: #eee; padding: 2px; margin-bottom: 5px;">Schematic</div> 
<div style="background-color: #eee; padding: 2px; margin-bottom: 5px;">Types</div> <ul style="list-style-type: none"> V23990-P764-A-PM V23990-P764-AY-PM 	

Maximum Ratings

$T_j = 25\text{ °C}$, unless otherwise specified

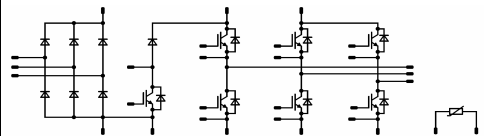
Parameter	Symbol	Condition	Value	Unit
Input Rectifier Diode				
Repetitive peak reverse voltage	V_{RRM}		1600	V
Forward current	I_{FAV}		75	A
Surge (non-repetitive) forward current	I_{FSM}	$t_p = 10\text{ ms}$	1000	A
I ² t-value	I^2t		5000	A ² s
Power dissipation	P_{tot}	$T_j = T_{jmax}$ $T_s = 80\text{ °C}$	123	W
Maximum Junction Temperature	T_{jmax}		150	°C
Inverter Switch				
Collector-emitter breakdown voltage	V_{CE}		600	V
DC collector current	I_C		75	A
Repetitive peak collector current	I_{CRM}	t_p limited by T_{jmax}	225	A
Power dissipation	P_{tot}	$T_j = T_{jmax}$ $T_s = 80\text{ °C}$	141	W
Gate-emitter peak voltage	V_{GE}		±20	V
Short circuit ratings	t_{SC} V_{CC}	$T_j \leq 150\text{ °C}$ $V_{GE} = 15\text{ V}$	6 360	μs V
Maximum Junction Temperature	T_{jmax}		175	°C



Maximum Ratings

 $T_j = 25\text{ °C}$, unless otherwise specified

Parameter	Symbol	Condition	Value	Unit
-----------	--------	-----------	-------	------

Inverter Diode

Peak Repetitive Reverse Voltage	V_{RRM}		600	V
DC forward current	I_F	$T_j = T_{jmax}$ $T_s = 80\text{ °C}$	61	A
Repetitive peak forward current	I_{FRM}	t_p limited by T_{jmax}	150	A
Power dissipation	P_{tot}	$T_j = T_{jmax}$ $T_s = 80\text{ °C}$	101	W
Maximum Junction Temperature	T_{jmax}		175	°C

Brake Switch

Collector-emitter breakdown voltage	V_{CE}		600	V
DC collector current	I_C		50	A
Repetitive peak collector current	I_{CRM}	t_p limited by T_{jmax}	150	A
Power dissipation	P_{tot}	$T_j = T_{jmax}$ $T_s = 80\text{ °C}$	103	W
Gate-emitter peak voltage	V_{GE}		±20	V
Short circuit ratings	t_{SC} V_{CC}	$T_j \leq 150\text{ °C}$ $V_{GE} = 15\text{ V}$	6 360	µs V
Maximum Junction Temperature	T_{jmax}		175	°C

Brake Inverse Diode

Peak Repetitive Reverse Voltage	V_{RRM}		600	V
DC forward current	I_F		20	A
Repetitive peak forward current	I_{FRM}	t_p limited by T_{jmax}	40	A
Brake Inverse Diode	P_{tot}	$T_j = T_{jmax}$ $T_s = 80\text{ °C}$	55	W
Maximum Junction Temperature	T_{jmax}		175	°C

Brake Diode

Peak Repetitive Reverse Voltage	V_{RRM}		600	V
DC forward current	I_F		20	A
Repetitive peak forward current	I_{FRM}	t_p limited by T_{jmax}	40	A
Power dissipation	P_{tot}	$T_j = T_{jmax}$ $T_s = 80\text{ °C}$	55	W
Maximum Junction Temperature	T_{jmax}		175	°C

Thermal properties

Storage temperature	T_{stg}		-40...+125	°C
Operation temperature under switching condition	T_{op}		-40...+ T_{jmax} -25	°C



Maximum Ratings

$T_i = 25\text{ °C}$, unless otherwise specified

Parameter	Symbol	Condition	Value	Unit
Isolation Properties				
Isolation voltage	V_{isol}	DC Test Voltage* $t_p = 2\text{ s}$	4000	V
		AC Voltage $t_p = 1\text{ min}$	2500	V
Creepage distance			min 12,7	mm
Clearance		with Press-fit pins / with Solder pins	11,58 / 11,82	mm
Comparative Tracking Index	CTI		>200	

* 100 % tested in production



Characteristic Values

Parameter	Symbol	Conditions					Value			Unit	
		V_{GE} [V]	V_{GS} [V]	V_r [V]	V_{CE} [V]	V_{DS} [V]	I_C [A]	I_F [A]	I_D [A]		T_j [°C]

Input Rectifier Diode

Forward voltage	V_F					100	25 125		1,19 1,16	1,9		V
Threshold voltage (for power loss calc. only)	V_{th}						25 125		0,9 0,79			V
Slope resistance (for power loss calc. only)	r_t						25 125		0,003 0,004			Ω
Reverse current	I_r				1500		25 125			0,05 1,1		mA
Thermal resistance junction to heatsink	$R_{th(j-s)}$	$\lambda_{paste} = 3,4$ W/mK (PSX)							0,45			K/W

Inverter Switch

Gate emitter threshold voltage	$V_{GE(th)}$	$V_{CE} = V_{GE}$				0,0012	25		5	5,8	6,5	V
Collector-emitter saturation voltage	V_{CESat}		15			75	25 150			1,44 1,64	2,1	V
Collector-emitter cut-off current incl. Diode	I_{CES}		0	600			25				0,25	mA
Gate-emitter leakage current	I_{GES}		20	0			25				700	nA
Integrated Gate resistor	R_{gint}									none		Ω
Turn-on delay time	$t_{d(on)}$	$R_{goff} = 4$ Ω $R_{gon} = 4$ Ω	±15	300	75		25			103		ns
Rise time	t_r						150			100		
Turn-off delay time	$t_{d(off)}$						25			12		
Fall time	t_f						150			15		
Turn-on energy loss	E_{on}						25			0,4		mWs
Turn-off energy loss	E_{off}						150			0,69		
Input capacitance	C_{ies}									4620		pF
Output capacitance	C_{oss}	$f = 1$ MHz	0	25		25				288		
Reverse transfer capacitance	C_{rss}									137		
Gate charge	Q_G		±15	480	75	25				470		nC
Thermal resistance junction to heatsink	$R_{th(j-s)}$	$\lambda_{paste} = 3,4$ W/mK (PSX)								0,67		K/W

Inverter Diode

Diode forward voltage	V_F					75	25 150			1,64 1,62	2,2	V
Peak reverse recovery current	I_{RRM}	$R_{goff} = 4$ Ω	±15	300	75		25			91		A
Reverse recovery time	t_{rr}						150			126		
Reverse recovered charge	Q_{rr}						25			107	ns	
Peak rate of fall of recovery current	$(di_{rr}/dt)_{max}$						150			134		
Reverse recovered energy	E_{rec}						25			3,1		μC
							150			6,53		
							25			6092		A/μs
							150			5621		
Thermal resistance junction to heatsink	$R_{th(jH)}$	$\lambda_{paste} = 3,4$ W/mK (PSX)								0,91 1,6		mWs
										0,94		K/W



Characteristic Values

Parameter	Symbol	Conditions					Value			Unit
		V_{GE} [V] V_{GS} [V]	V_{CE} [V] V_{DS} [V]	I_C [A] I_F [A]	T_j [°C]	Min	Typ	Max		
Brake Switch										
Gate emitter threshold voltage	$V_{GE(th)}$	$V_{CE} = V_{CE}$			0,0008	25	5	5,8	6,5	V
Collector-emitter saturation voltage	V_{CEsat}		15		50	25 150		1,58 1,82	2,1	V
Collector-emitter cut-off incl diode	I_{CES}		0	600		25			0,5	mA
Gate-emitter leakage current	I_{GES}		20	0		25			700	nA
Integrated Gate resistor	R_{gint}							none		Ω
Turn-on delay time	$t_{d(on)}$					25 150		100 102		ns
Rise time	t_r					25 150		14 18,6		
Turn-off delay time	$t_{d(off)}$	$R_{gon} = 8 \Omega$ $R_{goff} = 8 \Omega$	± 15	300	50	25 150		158 185		
Fall time	t_f					25 150		108 125		
Turn-on energy loss	E_{on}					25 150		0,43 0,63		mWs
Turn-off energy loss	E_{off}					25 150		1,42 1,97		
Input capacitance	C_{ies}							3140		pF
Output capacitance	C_{oss}	$f = 1 \text{ MHz}$	0	25		25		200		
Reverse transfer capacitance	C_{rss}							90		
Gate charge	Q_G		± 15	480	50	25		310		nC
Thermal resistance junction to heatsink	$R_{th(j-s)}$	$\lambda_{poste} = 3,4 \text{ W/mK (PSX)}$						0,92		K/W
Brake Inverse Diode										
Diode forward voltage	V_F				10	25 150	1,2	1,78 1,77	2,1	V
Thermal resistance junction to heatsink	$R_{th(j-s)}$	$\lambda_{poste} = 3,4 \text{ W/mK (PSX)}$						1,74		K/W
Brake Diode										
Diode forward voltage	V_F				20	25 150		1,65 1,56	2,1	V
Reverse leakage current	I_r			300		25			140	μA
Peak reverse recovery current	I_{RRM}					25 150		40 47		A
Reverse recovery time	t_{rr}					25 150		22 141		ns
Reverse recovered charge	Q_{rr}	$R_{gon} = 8 \Omega$	± 15	300	50	25 150		1 2,37		μC
Peak rate of fall of recovery current	$(di_{rr}/dt)_{max}$					25 150		6000 3416		A/ μs
Reverse recovery energy	E_{rec}					25 150		0,35 0,58		mWs
Thermal resistance junction to heatsink	$R_{th(j-s)}$	$\lambda_{poste} = 3,4 \text{ W/mK (PSX)}$						1,74		K/W
Thermistor										
Rated resistance	R_{25}					25	20,9	22	23,1	k Ω
Deviation of R_{100}	$D_{R/R}$	$R_{100} = 1486 \Omega$				100		2,9		%
Power dissipation	P					25		210		mW
Power dissipation constant	$B_{(25/100)}$	Tol. $\pm 3\%$				25		2		K



Output Inverter

figure 1. IGBT

Typical output characteristics

$I_C = f(V_{CE})$

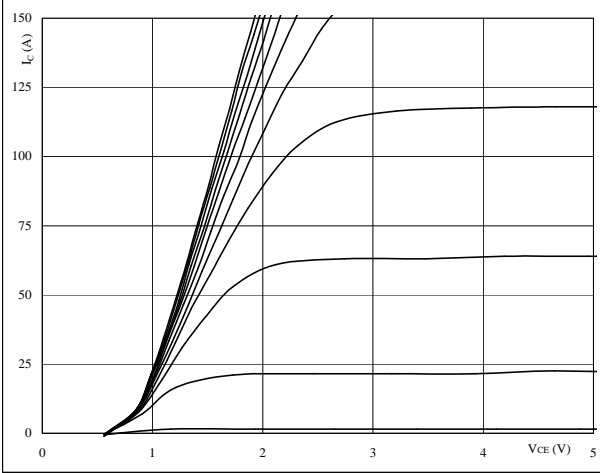

At

$t_p = 250 \mu s$
 $T_j = 25 \text{ }^\circ C$

VGE from 7 V to 17 V in steps of 1 V

figure 2. IGBT

Typical output characteristics

$I_C = f(V_{CE})$

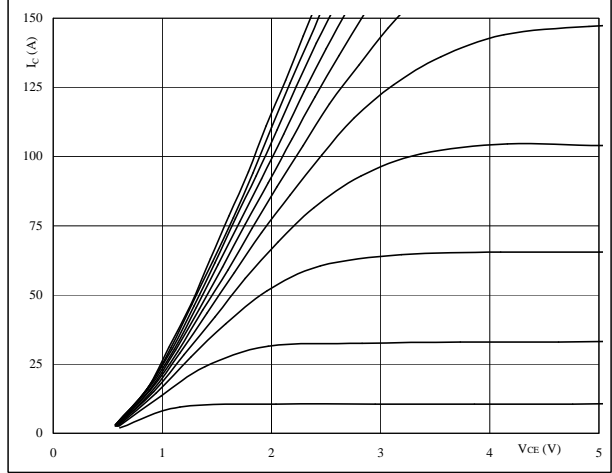

At

$t_p = 250 \mu s$
 $T_j = 150 \text{ }^\circ C$

VGE from 7 V to 17 V in steps of 1 V

figure 3. IGBT

Typical transfer characteristics

$I_C = f(V_{GE})$

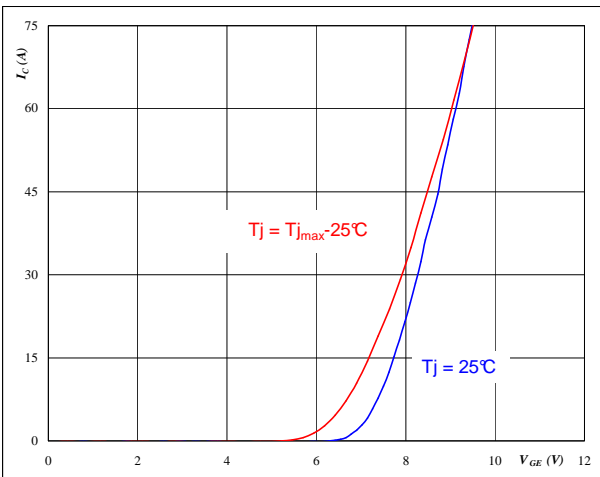

At

$t_p = 250 \mu s$
 $V_{CE} = 10 V$

figure 4. FWD

Typical diode forward current as a function of forward voltage

$I_F = f(V_F)$

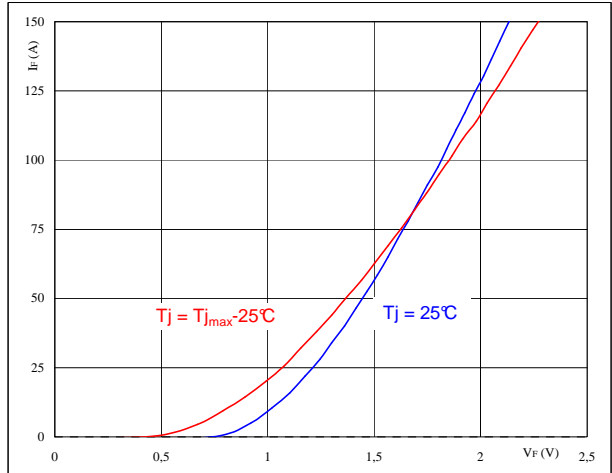

At

$t_p = 250 \mu s$



Output Inverter

figure 5. IGBT

Typical switching energy losses as a function of collector current

$$E = f(I_c)$$

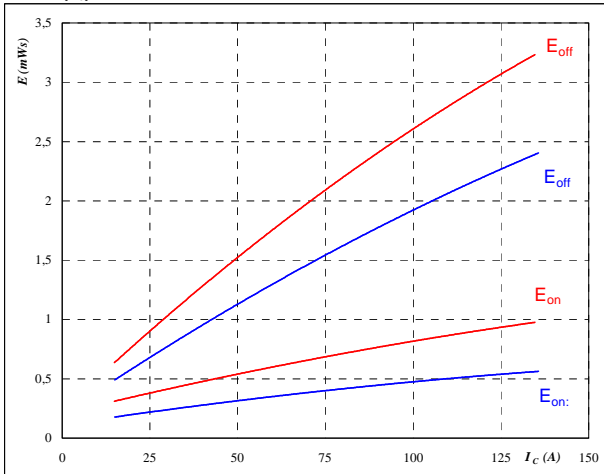

With an inductive load at

$T_j = 25/150$ °C
 $V_{CE} = 300$ V
 $V_{GE} = \pm 15$ V
 $R_{gon} = 4$ Ω
 $R_{goff} = 4$ Ω

figure 6. IGBT

Typical switching energy losses as a function of gate resistor

$$E = f(R_G)$$

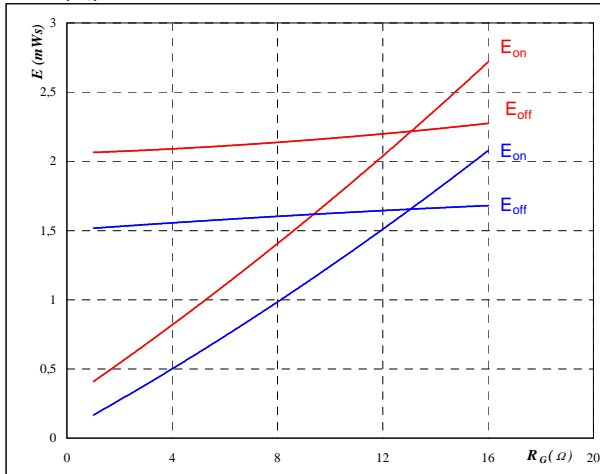

With an inductive load at

$T_j = 25/150$ °C
 $V_{CE} = 300$ V
 $V_{GE} = \pm 15$ V
 $I_c = 75$ A

figure 7. IGBT

Typical reverse recovery energy loss as a function of collector current

$$E_{rec} = f(I_c)$$

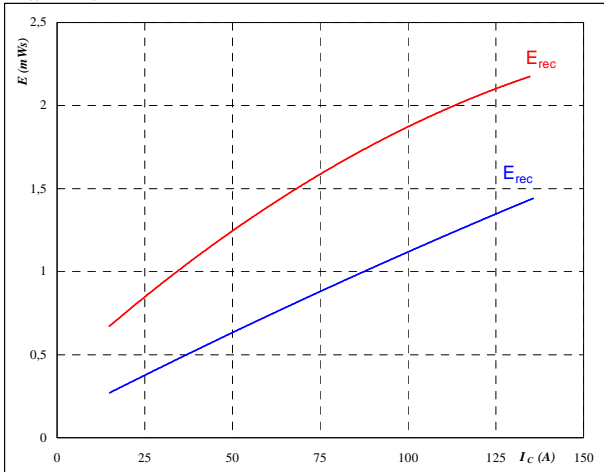

With an inductive load at

$T_j = 25/150$ °C
 $V_{CE} = 300$ V
 $V_{GE} = \pm 15$ V
 $R_{gon} = 4$ Ω

figure 8. IGBT

Typical reverse recovery energy loss as a function of gate resistor

$$E_{rec} = f(R_G)$$

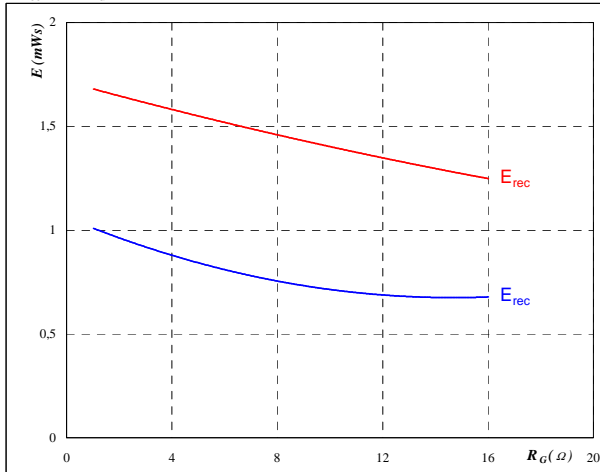

With an inductive load at

$T_j = 25/150$ °C
 $V_{CE} = 300$ V
 $V_{GE} = \pm 15$ V
 $I_c = 75$ A



Output Inverter

figure 9. IGBT

Typical switching times as a function of collector current

$$t = f(I_C)$$

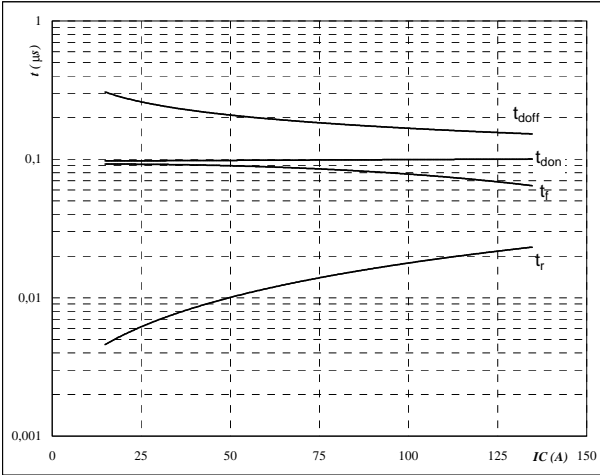

With an inductive load at

- $T_j = 150$ °C
- $V_{CE} = 300$ V
- $V_{GE} = \pm 15$ V
- $R_{gon} = 4$ Ω
- $R_{goff} = 4$ Ω

figure 10. IGBT

Typical switching times as a function of gate resistor

$$t = f(R_G)$$

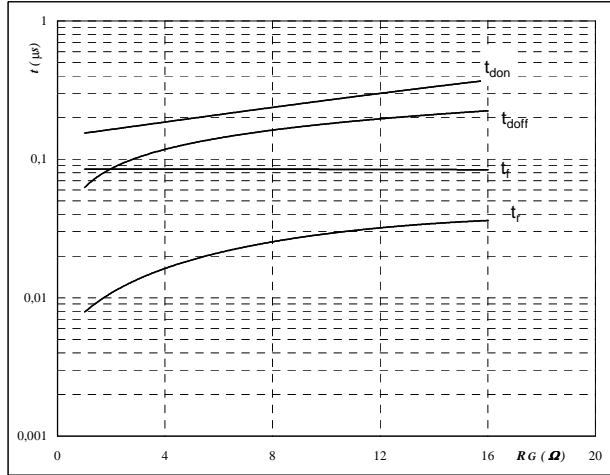

With an inductive load at

- $T_j = 150$ °C
- $V_{CE} = 300$ V
- $V_{GE} = \pm 15$ V
- $I_C = 75$ A

figure 11. FWD

Typical reverse recovery time as a function of collector current

$$t_{rr} = f(I_C)$$

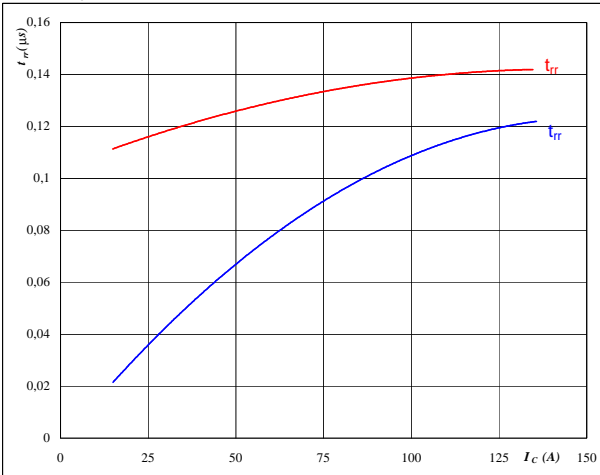

At

- $T_j = 25/150$ °C
- $V_{CE} = 300$ V
- $V_{GE} = \pm 15$ V
- $R_{gon} = 4$ Ω

figure 12. FWD

Typical reverse recovery time as a function of IGBT turn on gate resistor

$$t_{rr} = f(R_{gon})$$

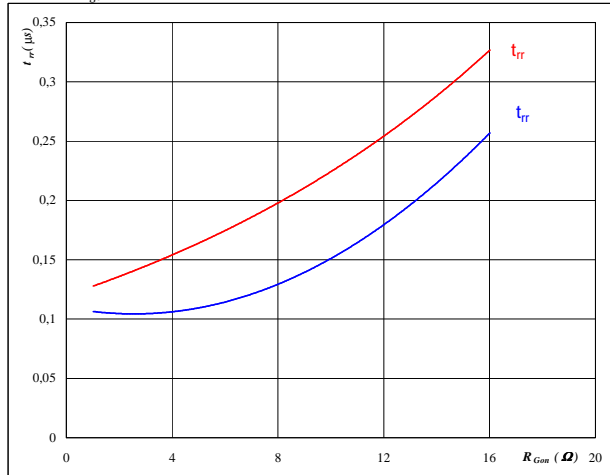

At

- $T_j = 25/150$ °C
- $V_R = 300$ V
- $I_F = 75$ A
- $V_{GE} = \pm 15$ V



Output Inverter

figure 13. FWD

Typical reverse recovery charge as a function of collector current

$$Q_{rr} = f(I_c)$$

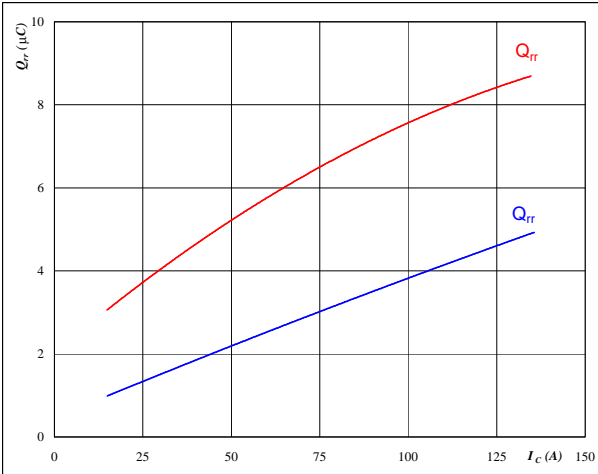

At

$$T_j = 25/150 \text{ } ^\circ\text{C}$$

$$V_{CE} = 300 \text{ V}$$

$$V_{GE} = \pm 15 \text{ V}$$

$$R_{gon} = 4 \text{ } \Omega$$

figure 14. FWD

Typical reverse recovery charge as a function of IGBT turn on gate resistor

$$Q_{rr} = f(R_{gon})$$

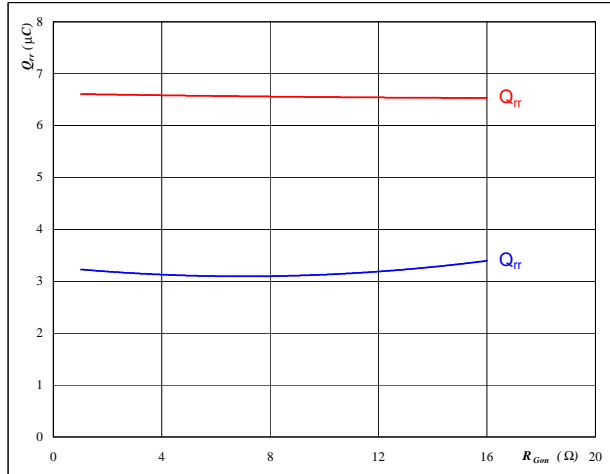

At

$$T_j = 25/150 \text{ } ^\circ\text{C}$$

$$V_R = 300 \text{ V}$$

$$I_F = 75 \text{ A}$$

$$V_{GE} = \pm 15 \text{ V}$$

figure 15. FWD

Typical reverse recovery current as a function of collector current

$$I_{RRM} = f(I_c)$$

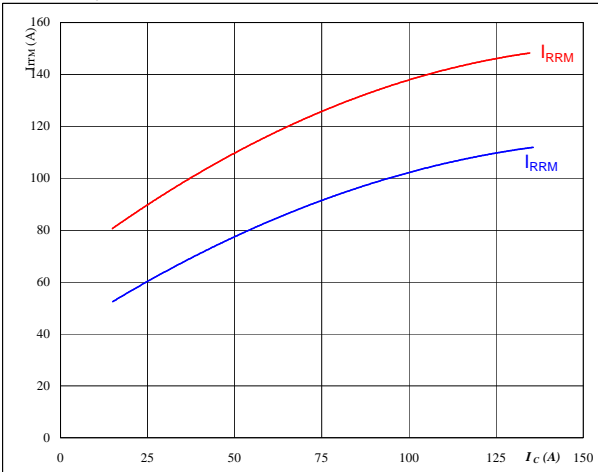

At

$$T_j = 25/150 \text{ } ^\circ\text{C}$$

$$V_{CE} = 300 \text{ V}$$

$$V_{GE} = \pm 15 \text{ V}$$

$$R_{gon} = 4 \text{ } \Omega$$

figure 16. FWD

Typical reverse recovery current as a function of IGBT turn on gate resistor

$$I_{RRM} = f(R_{gon})$$

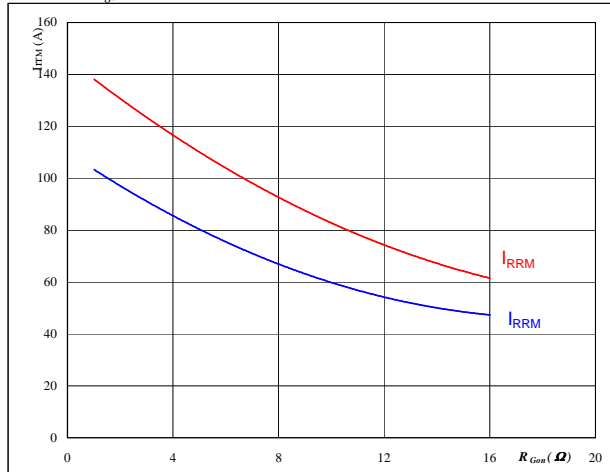

At

$$T_j = 25/150 \text{ } ^\circ\text{C}$$

$$V_R = 300 \text{ V}$$

$$I_F = 75 \text{ A}$$

$$V_{GE} = \pm 15 \text{ V}$$



Output Inverter

figure 17. FWD

Typical rate of fall of forward and reverse recovery current as a function of collector current

$$dI_0/dt, dI_{rec}/dt = f(I_c)$$

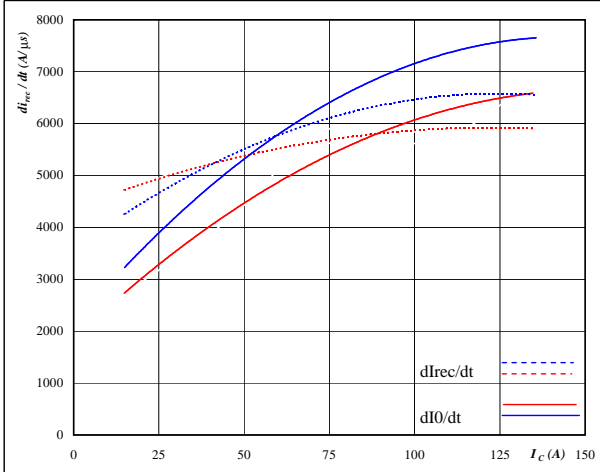

At
 $T_j = 25/150$ °C
 $V_{CE} = 300$ V
 $V_{GE} = \pm 15$ V
 $R_{gon} = 4$ Ω

figure 18. FWD

Typical rate of fall of forward and reverse recovery current as a function of IGBT turn on gate resistor

$$dI_0/dt, dI_{rec}/dt = f(R_{gon})$$

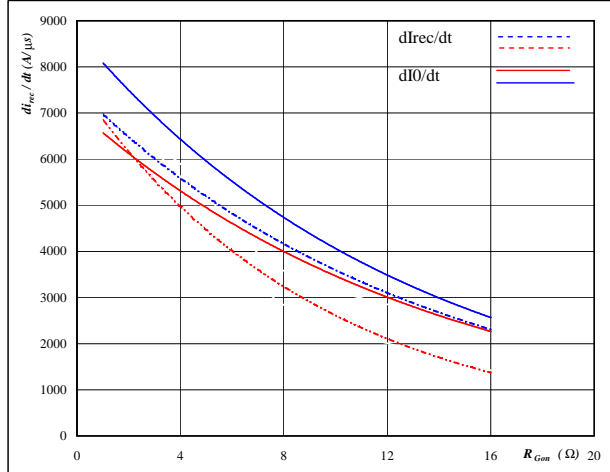

At
 $T_j = 25/150$ °C
 $V_R = 300$ V
 $I_F = 75$ A
 $V_{GE} = \pm 15$ V

figure 19. IGBT

IGBT transient thermal impedance as a function of pulse width

$$Z_{th(j-s)} = f(t_p)$$

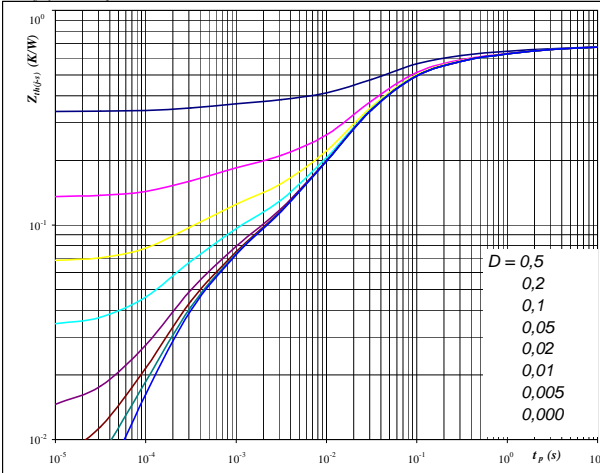

At
 $D = t_p / T$
 $R_{th(j-s)} = 0,67$ K/W
 Single device heated
 IGBT thermal model values

R (K/W)	Tau (s)
6,75E-02	2,23E+00
8,44E-02	3,55E-01
2,24E-01	6,67E-02
2,17E-01	2,09E-02
3,30E-02	2,25E-03
4,91E-02	3,14E-04

figure 20. FWD

FWD transient thermal impedance as a function of pulse width

$$Z_{th(j-s)} = f(t_p)$$

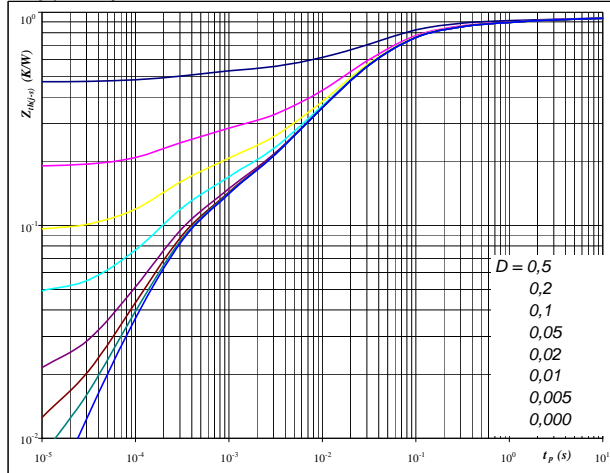

At
 $D = t_p / T$
 $R_{th(j-s)} = 0,94$ K/W
 Single device heated
 FWD thermal model values

R (K/W)	Tau (s)
4,04E-02	4,44E+00
6,04E-02	6,95E-01
2,05E-01	1,07E-01
4,29E-01	2,58E-02
1,08E-01	3,79E-03
9,95E-02	2,58E-04



Output Inverter

figure 21. IGBT

Power dissipation as a function of heatsink temperature

$$P_{tot} = f(T_s)$$

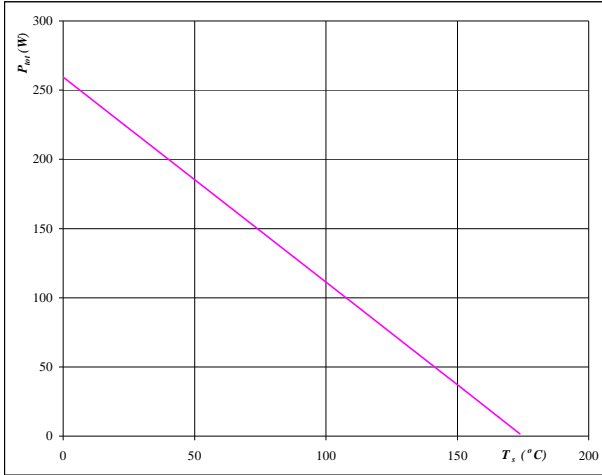

At
T_j = 175 °C

figure 22. IGBT

Collector current as a function of heatsink temperature

$$I_C = f(T_s)$$

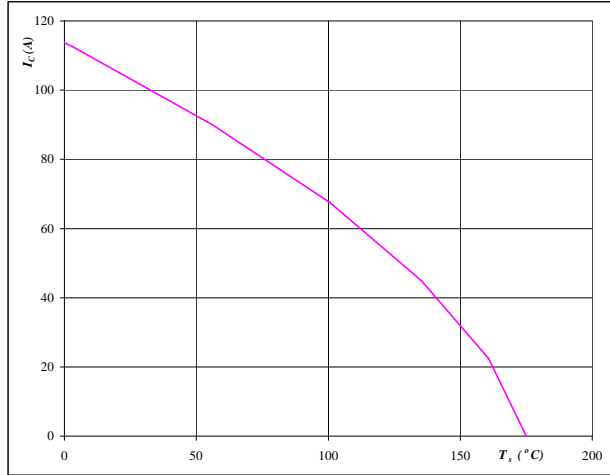

At
T_j = 175 °C
V_{GE} = 15 V

figure 23. FWD

Power dissipation as a function of heatsink temperature

$$P_{tot} = f(T_s)$$

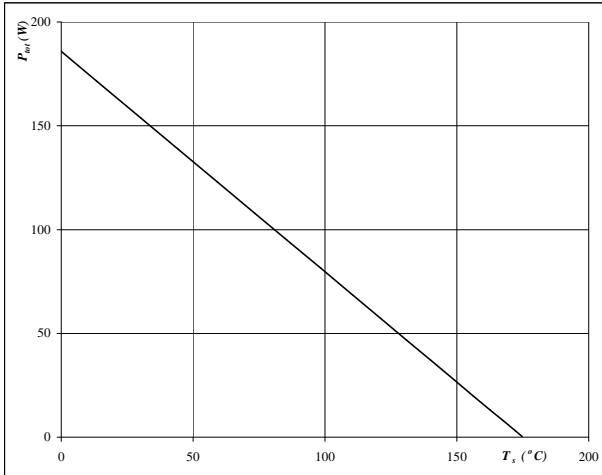

At
T_j = 175 °C

figure 24. FWD

Forward current as a function of heatsink temperature

$$I_F = f(T_s)$$

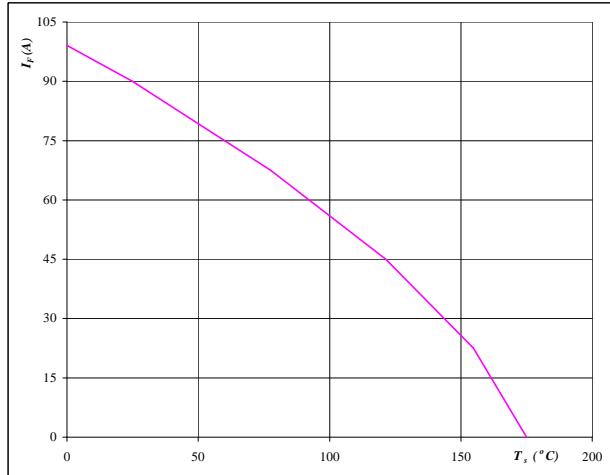

At
T_j = 175 °C



Output Inverter

figure 25. IGBT

Safe operating area as a function of collector-emitter voltage

$I_C = f(V_{CE})$

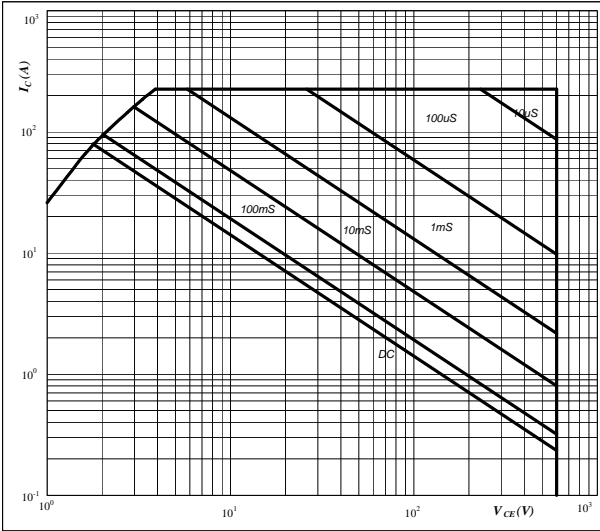

At
 $D =$ single pulse
 $T_s =$ 80 °C
 $V_{GE} =$ ±15 V
 $T_j = T_{jmax}$

figure 26. IGBT

Gate voltage vs Gate charge

$V_{GE} = f(Q_g)$

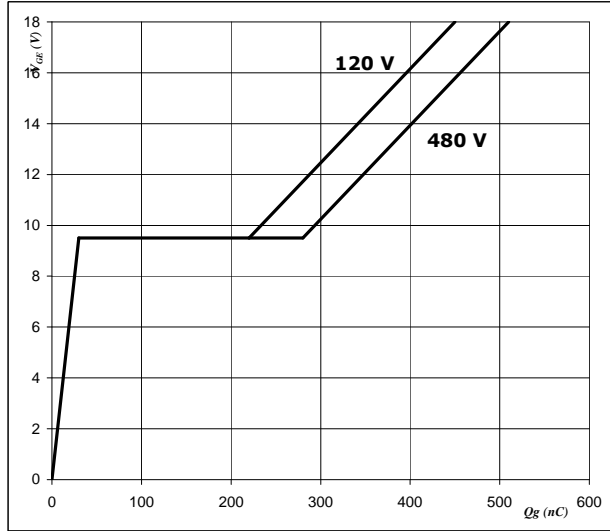

At
 $I_C =$ 75 A



Brake

figure 1. IGBT

Typical output characteristics

$I_C = f(V_{CE})$

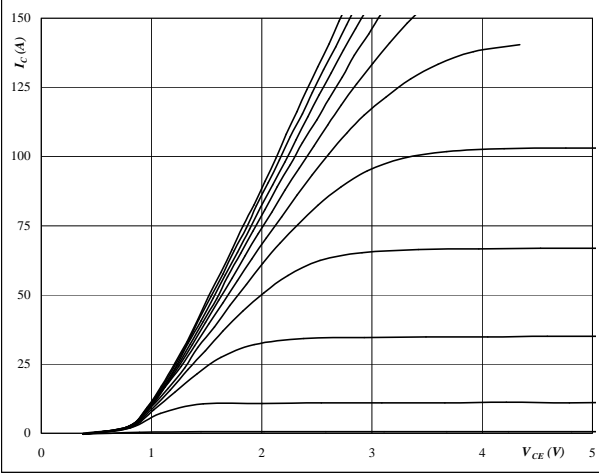

At

$t_p = 250 \mu s$
 $T_j = 25 \text{ } ^\circ C$
VGE from 7 V to 17 V in steps of 1 V

figure 2. IGBT

Typical output characteristics

$I_C = f(V_{CE})$

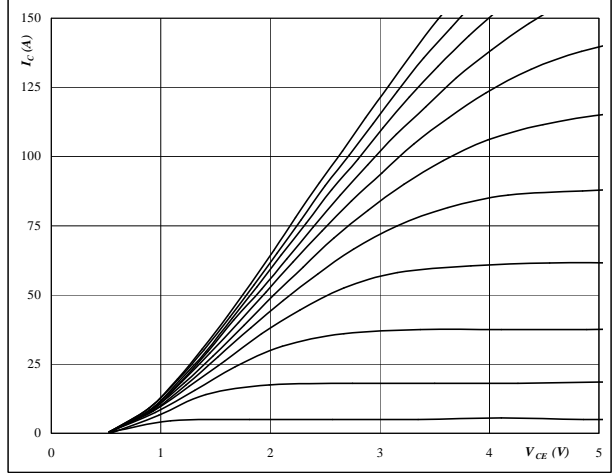

At

$t_p = 250 \mu s$
 $T_j = 150 \text{ } ^\circ C$
VGE from 7 V to 17 V in steps of 1 V

figure 3. IGBT

Typical transfer characteristics

$I_C = f(V_{GE})$

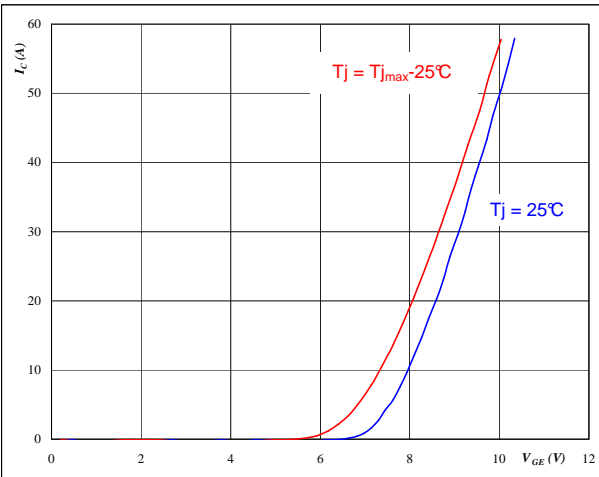

At

$t_p = 250 \mu s$
 $V_{CE} = 10 V$

figure 4. FWD

Typical diode forward current as a function of forward voltage

$I_F = f(V_F)$

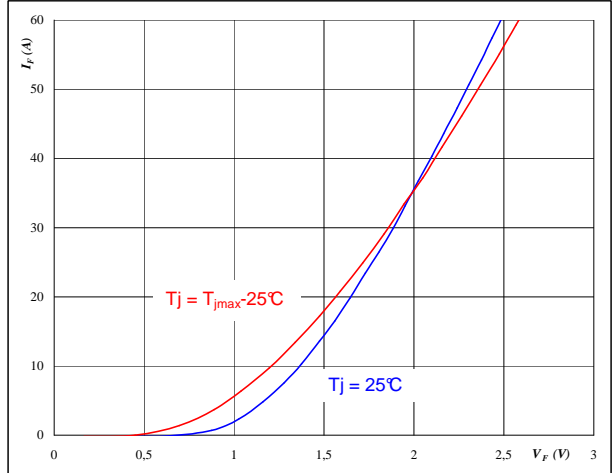

At

$t_p = 250 \mu s$



Brake

figure 5. IGBT

Typical switching energy losses
as a function of collector current

$E = f(I_C)$

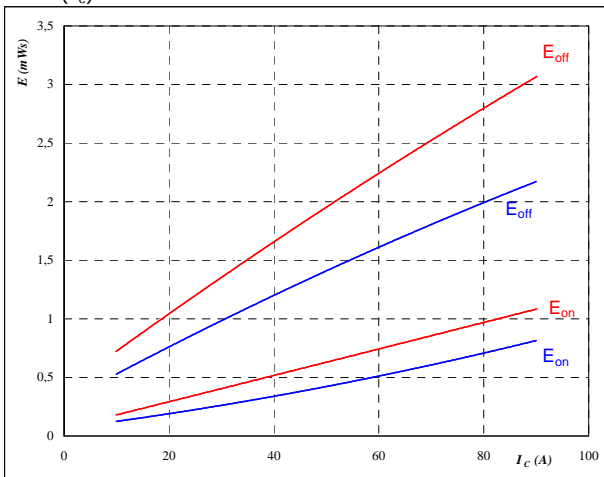

With an inductive load at

- $T_j = 25/150$ °C
- $V_{CE} = 300$ V
- $V_{GE} = \pm 15$ V
- $R_{gon} = 8$ Ω
- $R_{goff} = 8$ Ω

figure 6. IGBT

Typical switching energy losses
as a function of gate resistor

$E = f(R_G)$

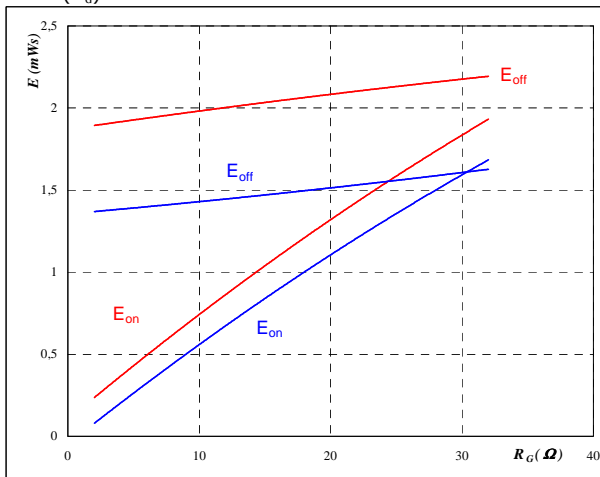

With an inductive load at

- $T_j = 25/150$ °C
- $V_{CE} = 300$ V
- $V_{GE} = \pm 15$ V
- $I_C = 50$ A

figure 7. IGBT

Typical reverse recovery energy loss
as a function of collector current

$E_{rec} = f(I_C)$

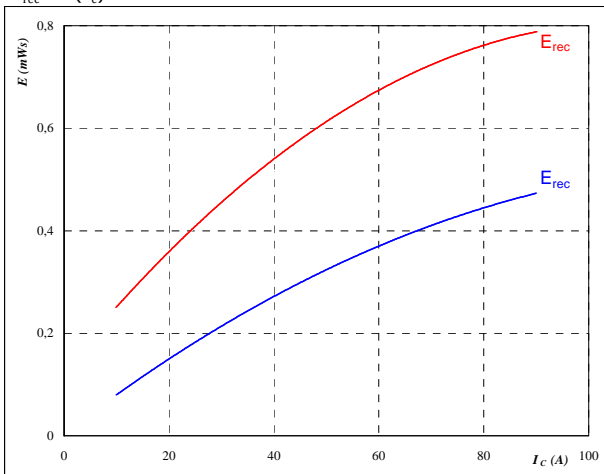

With an inductive load at

- $T_j = 25/150$ °C
- $V_{CE} = 300$ V
- $V_{GE} = \pm 15$ V
- $R_{gon} = 8$ Ω

figure 8. IGBT

Typical reverse recovery energy loss
as a function of gate resistor

$E_{rec} = f(R_G)$

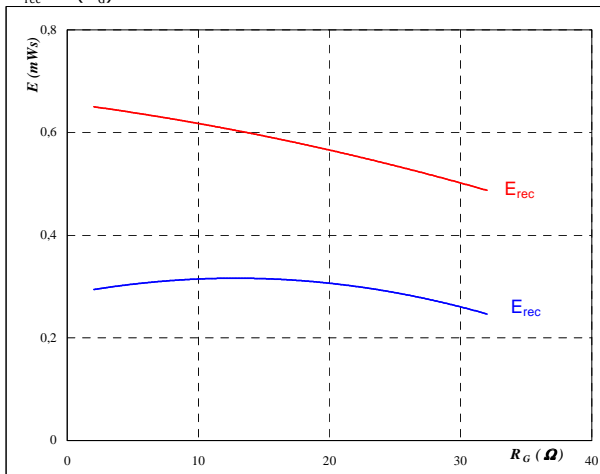

With an inductive load at

- $T_j = 25/150$ °C
- $V_{CE} = 300$ V
- $V_{GE} = \pm 15$ V
- $I_C = 50$ A



Brake

figure 9. IGBT

Typical switching times as a function of collector current

$t = f(I_C)$

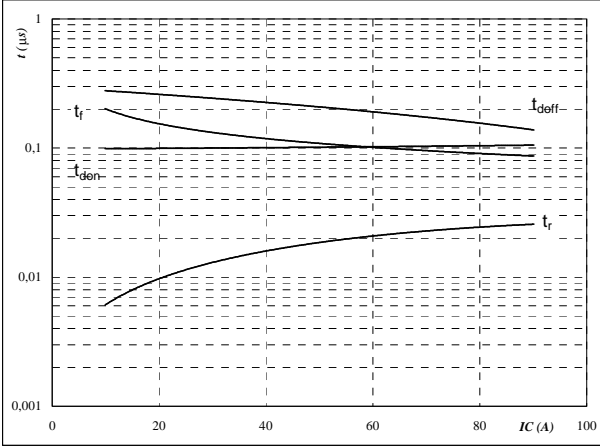

With an inductive load at
 $T_j = 150 \text{ } ^\circ\text{C}$
 $V_{CE} = 300 \text{ V}$
 $V_{GE} = \pm 15 \text{ V}$
 $R_{gon} = 8 \text{ } \Omega$
 $R_{goff} = 8 \text{ } \Omega$

figure 10. IGBT

Typical switching times as a function of gate resistor

$t = f(R_G)$

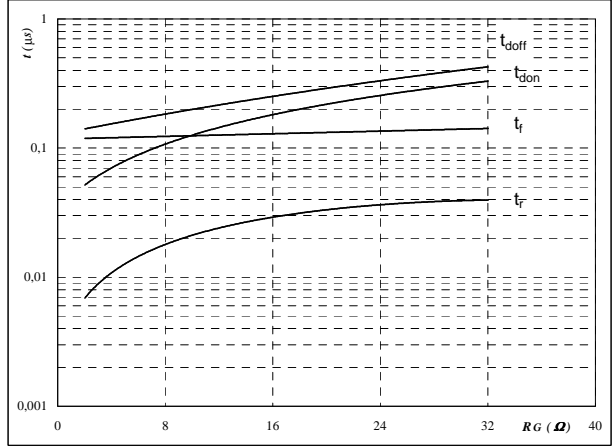

With an inductive load at
 $T_j = 150 \text{ } ^\circ\text{C}$
 $V_{CE} = 300 \text{ V}$
 $V_{GE} = \pm 15 \text{ V}$
 $I_C = 50 \text{ A}$

figure 11. IGBT

IGBT transient thermal impedance as a function of pulse width

$Z_{th(i-s)} = f(t_p)$

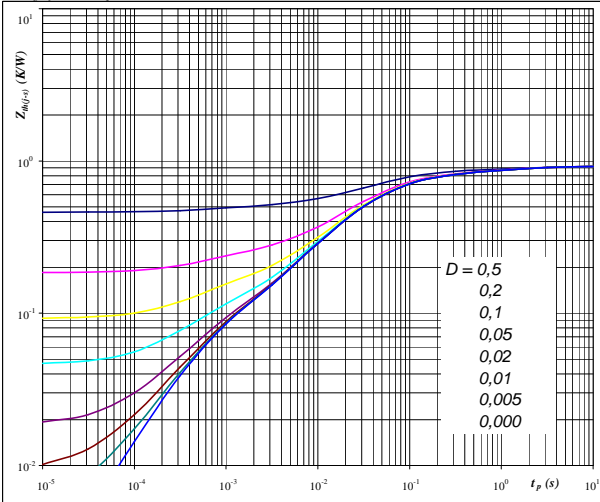

At
 $D = t_p / T$
 $R_{th(i-s)} = 0,92 \text{ K/W}$

figure 12. IGBT

FWD transient thermal impedance as a function of pulse width

$Z_{th(f-s)} = f(t_p)$

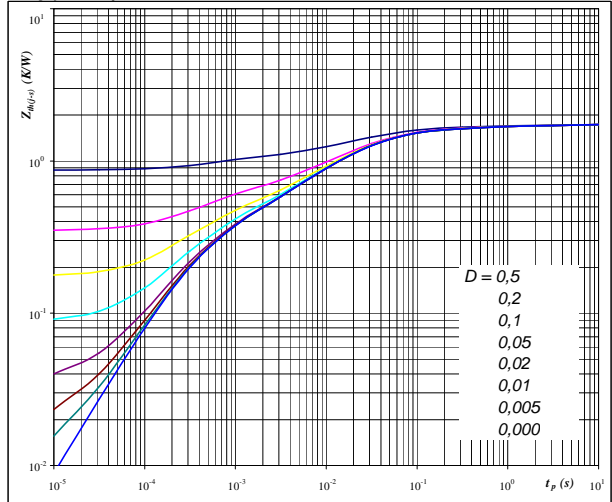

At
 $D = t_p / T$
 $R_{th(f-s)} = 1,74 \text{ K/W}$



Brake

figure 13. IGBT

Power dissipation as a function of heatsink temperature

$$P_{tot} = f(T_s)$$

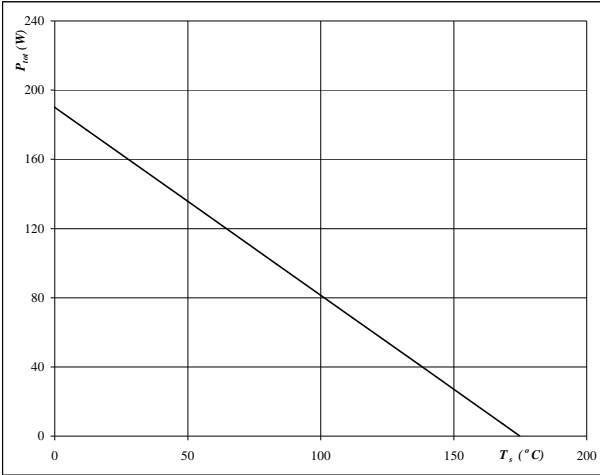

At
T_j = 175 °C

figure 14. IGBT

Collector current as a function of heatsink temperature

$$I_C = f(T_s)$$

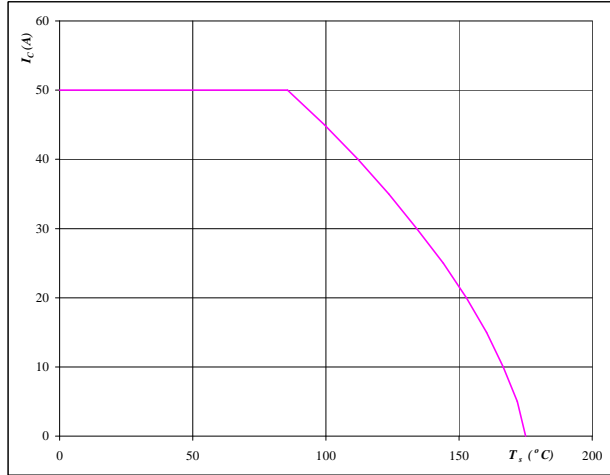

At
T_j = 175 °C
V_{GE} = 15 V

figure 15. FWD

Power dissipation as a function of heatsink temperature

$$P_{tot} = f(T_s)$$

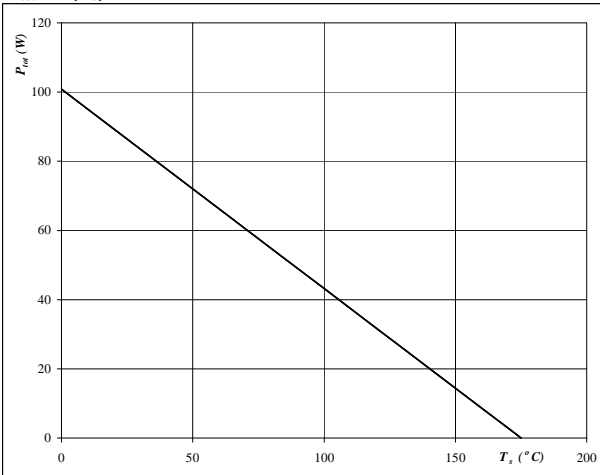

At
T_j = 175 °C

figure 16. FWD

Forward current as a function of heatsink temperature

$$I_F = f(T_s)$$

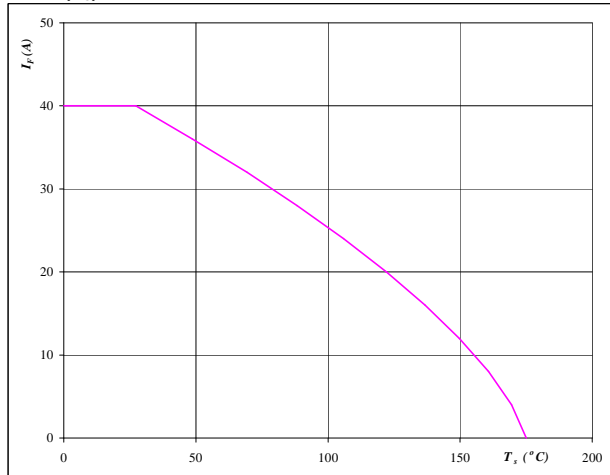

At
T_j = 175 °C



Brake Inverse Diode

figure 1. Brake inverse diode

Typical diode forward current as a function of forward voltage

$$I_F = f(V_F)$$

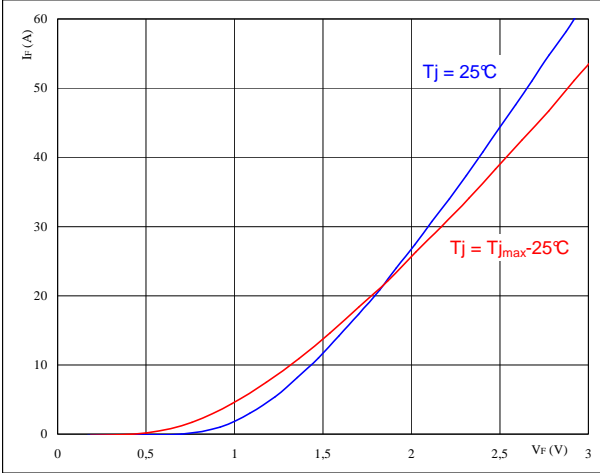

At
 $t_p = 250 \mu\text{s}$

figure 2. Brake inverse diode

Diode transient thermal impedance as a function of pulse width

$$Z_{th(j-s)} = f(t_p)$$

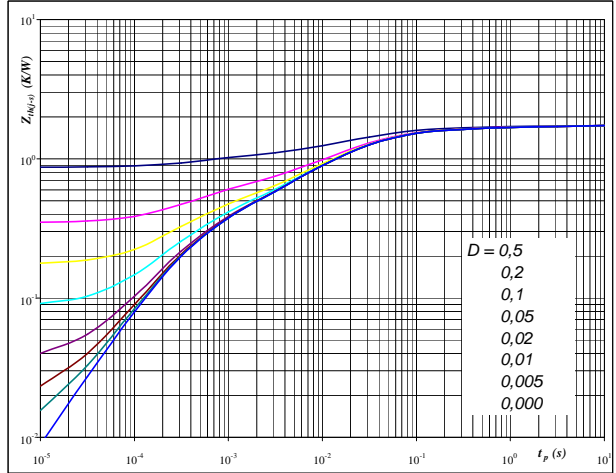

At
 $D = t_p / T$
 $R_{th(j-s)} = 1,74 \text{ K/W}$

figure 3. Brake inverse diode

Power dissipation as a function of heatsink temperature

$$P_{tot} = f(T_s)$$

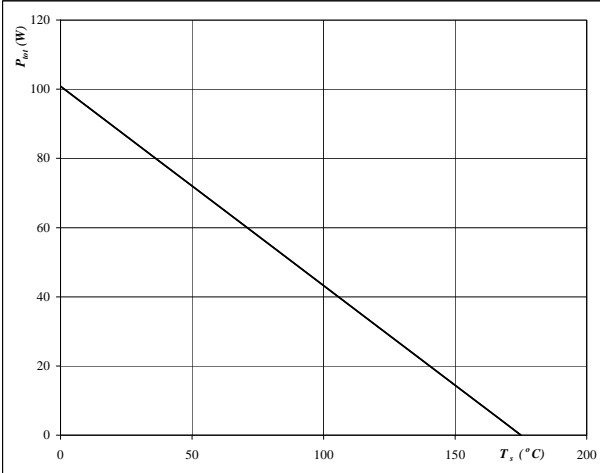

At
 $T_j = 175 \text{ }^\circ\text{C}$

figure 4. Brake inverse diode

Forward current as a function of heatsink temperature

$$I_F = f(T_s)$$

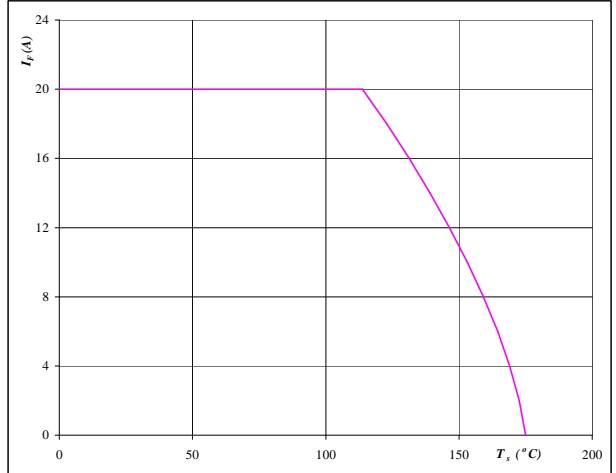

At
 $T_j = 175 \text{ }^\circ\text{C}$



Input Rectifier Bridge

figure 1. Rectifier Diode

Typical diode forward current as a function of forward voltage

$I_F = f(V_F)$

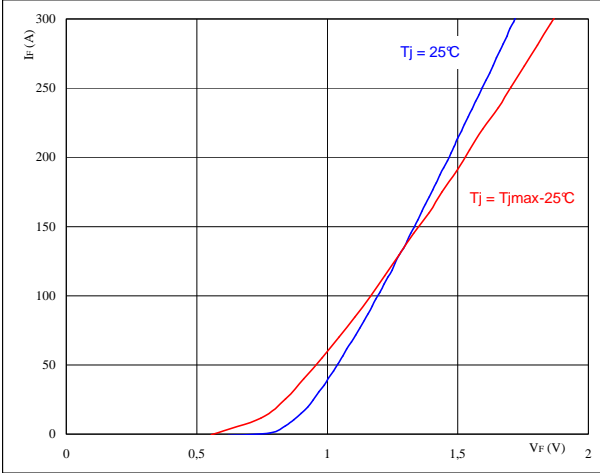

At
 $t_p = 250 \mu s$

figure 2. Rectifier Diode

Diode transient thermal impedance as a function of pulse width

$Z_{th(j-s)} = f(t_p)$

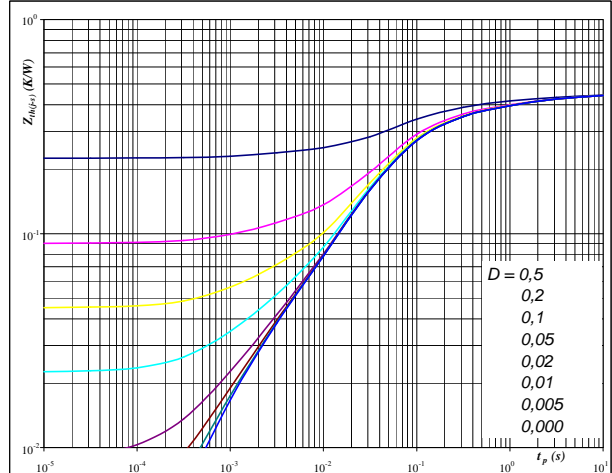

At
 $D = t_p / T$
 $R_{th(j-s)} = 0,45 \text{ K/W}$

figure 3. Rectifier Diode

Power dissipation as a function of heatsink temperature

$P_{tot} = f(T_s)$

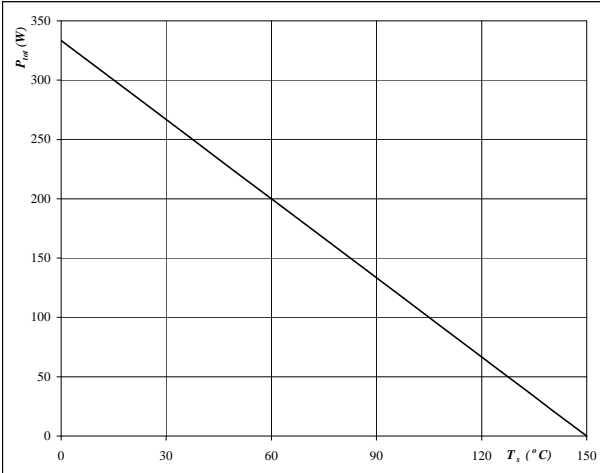

At
 $T_j = 150 \text{ °C}$

figure 4. Rectifier Diode

Forward current as a function of heatsink temperature

$I_F = f(T_s)$

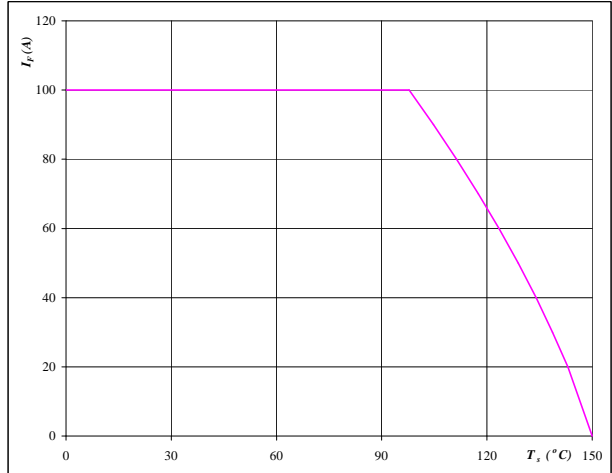

At
 $T_j = 150 \text{ °C}$



Thermistor

figure 1. Thermistor

**Typical NTC characteristic
as a function of temperature**

$$R_T = f(T)$$

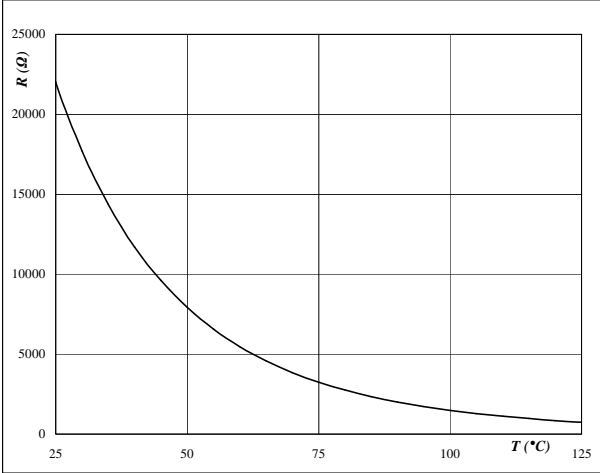



Switching Definitions Output Inverter

General conditions

T_j	=	150 °C
R_{gon}	=	4 Ω
R_{goff}	=	4 Ω

figure 1. IGBT

Turn-off Switching Waveforms & definition of t_{doff} , t_{Eoff}
(t_{Eoff} = integrating time for E_{off})

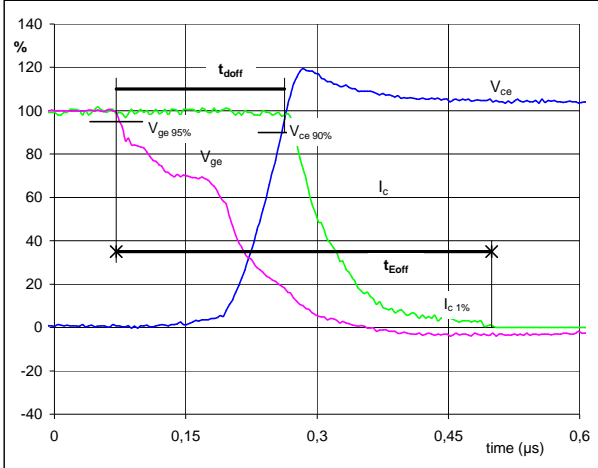

V_{GE} (0%) =	-15	V
V_{GE} (100%) =	15	V
V_C (100%) =	300	V
I_C (100%) =	75	A
t_{doff} =	0,18	μs
t_{Eoff} =	0,43	μs

figure 2. IGBT

Turn-on Switching Waveforms & definition of t_{donr} , t_{Eon}
(t_{Eon} = integrating time for E_{on})

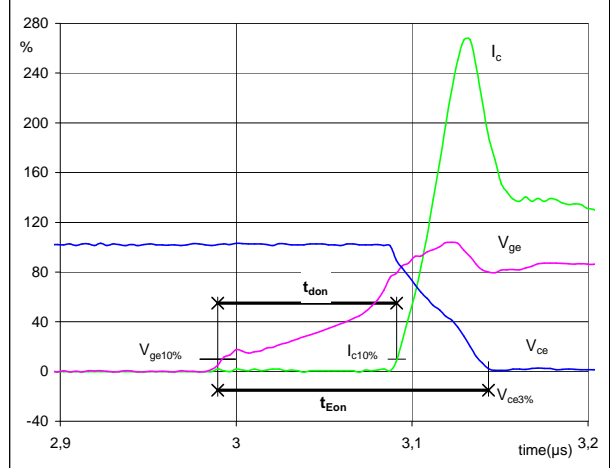

V_{GE} (0%) =	-15	V
V_{GE} (100%) =	15	V
V_C (100%) =	300	V
I_C (100%) =	75	A
t_{donr} =	0,10	μs
t_{Eon} =	0,15	μs

figure 3. IGBT

Turn-off Switching Waveforms & definition of t_f

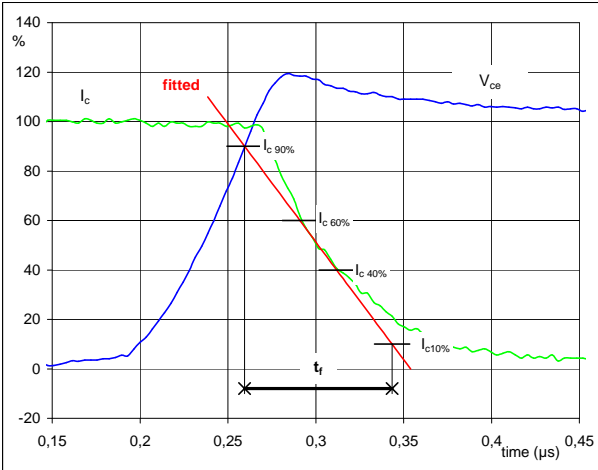

V_C (100%) =	300	V
I_C (100%) =	75	A
t_f =	0,09	μs

figure 4. IGBT

Turn-on Switching Waveforms & definition of t_r

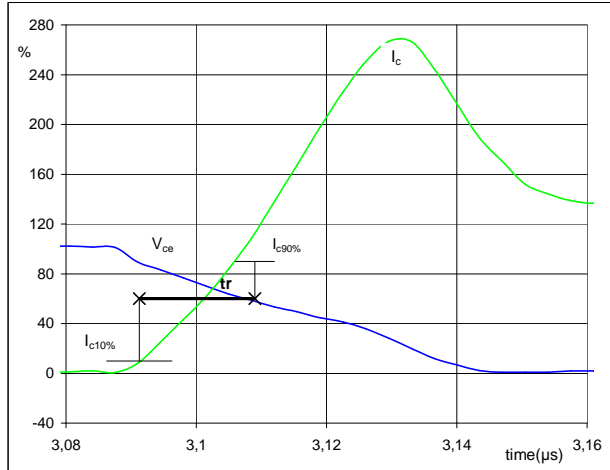

V_C (100%) =	300	V
I_C (100%) =	75	A
t_r =	0,02	μs



Switching Definitions Output Inverter

figure 5. IGBT
Turn-off Switching Waveforms & definition of t_{Eoff}

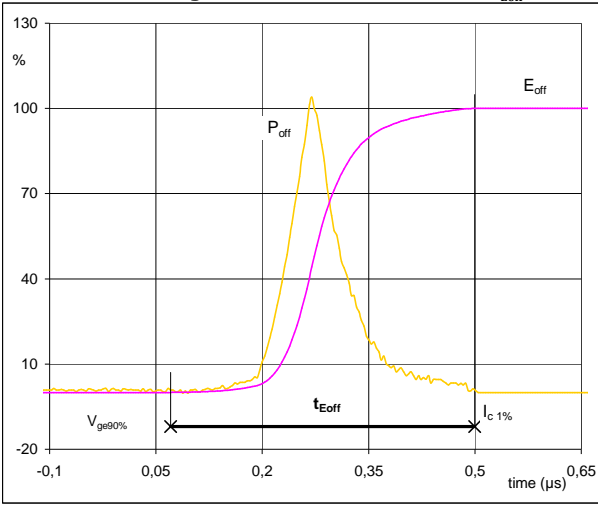

$P_{off} (100\%) =$	22,48	kW
$E_{off} (100\%) =$	2,09	mJ
$t_{Eoff} =$	0,43	μs

figure 6. IGBT
Turn-on Switching Waveforms & definition of t_{Eon}

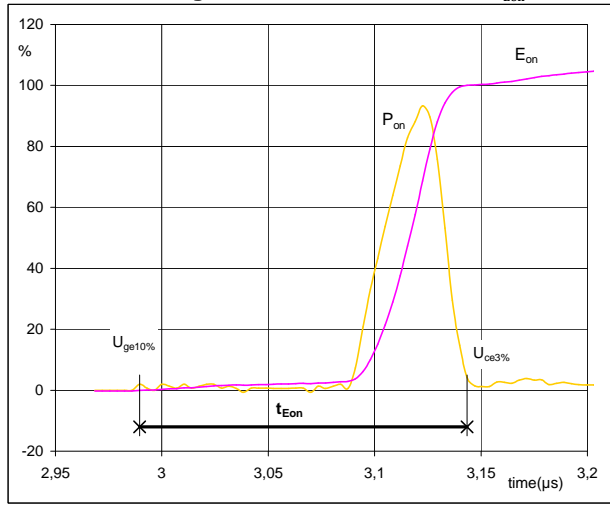

$P_{on} (100\%) =$	22,48	kW
$E_{on} (100\%) =$	0,69	mJ
$t_{Eon} =$	0,15	μs

figure 7. FWD
Turn-off Switching Waveforms & definition of t_{rr}

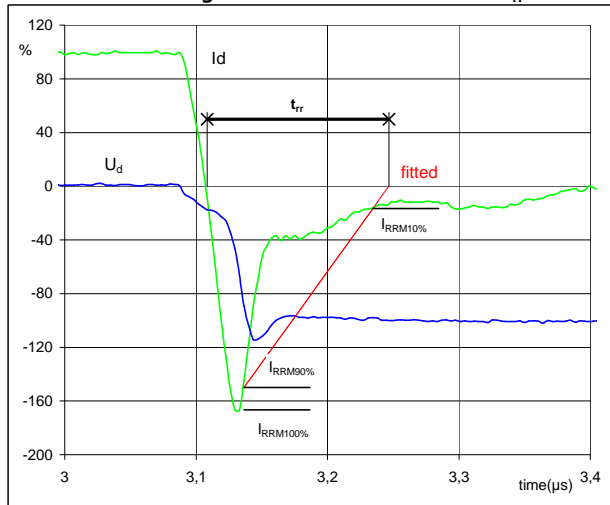

$V_d (100\%) =$	300	V
$I_d (100\%) =$	75	A
$I_{RRM} (100\%) =$	-126	A
$t_{rr} =$	0,13	μs



Switching Definitions Output Inverter

figure 8. FWD

Turn-on Switching Waveforms & definition of t_{Qrr}
(t_{Qrr} = integrating time for Q_{rr})

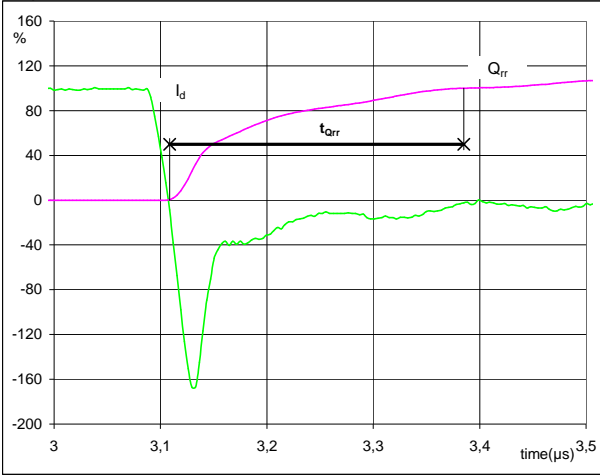

I_d (100%) =	75	A
Q_{rr} (100%) =	6,53	μC
t_{Qint} =	0,28	μs

figure 9. FWD

Turn-on Switching Waveforms & definition of t_{Erec}
(t_{Erec} = integrating time for E_{rec})

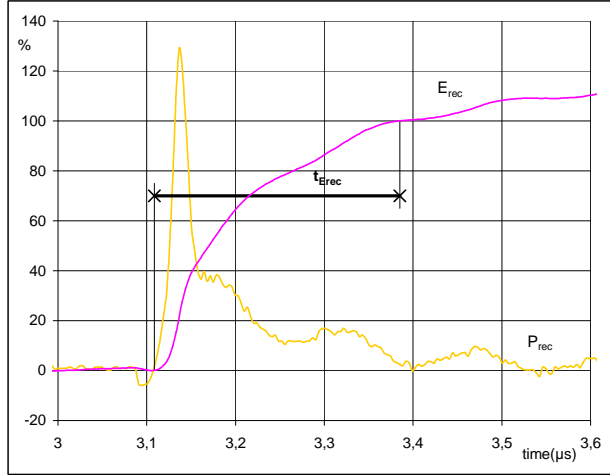

P_{rec} (100%) =	22,48	kW
E_{rec} (100%) =	1,60	mJ
t_{Erec} =	0,28	μs



Ordering Code & Marking							
Version				Ordering Code			
without thermal paste with solder pins				V23990-P764-A-PM			
without thermal paste with Press-fit pins				V23990-P764-AY-PM			
with thermal paste with solder pins				V23990-P764-A-/3/-PM			
with thermal paste with Press-fit pins				V23990-P764-AY-/3/-PM			
	Text	VIN	Date code	Name&Ver	UL	Lot	Serial
		VIN	WWYY	NNNNNVV	UL	LLLL	SSSS
	Datamatrix	Type&Ver	Lot number	Serial	Date code		
		TTTTTIV	LLLL	SSSS	WWYY		

Outline									
Pin table [mm]				Pin table [mm]				Pin	Func
Pin	Func	X	Y	Pin	Func	X	Y		
1	DC-	71,2	0	29	U	0	37,2		
2	DC-	68,7	0	30	U	2,5	37,2		
3	DC-	66,2	0	31	U	5	37,2		
4	DC-	63,7	0	32	E	7,8	37,2		
5	DC+	55,95	0	33	G	10,6	37,2		
6	DC+	53,45	0	34	G	18,45	37,2		
7	DC+	55,95	2,8	35	E	21,25	37,2		
8	DC+	53,45	2,8	36	V	24,05	37,2		
9	DC+	48,4	0	37	V	26,55	37,2		
10	DC+	45,9	0	38	V	29,05	37,2		
11	E	38,9	0	39	W	36,1	37,2		
12	DC-	36,1	0	40	W	38,6	37,2		
13	G	38,9	2,8	41	W	41,1	37,2		
14	DC-	36,1	2,8	42	E	43,9	37,2		
15	DC-	31,3	0	43	G	46,7	37,2		
16	E	28,5	0	44	L1	53,7	37,2		
17	DC-	31,3	2,8	45	L1	56,2	37,2		
18	G	28,5	2,8	46	L1	58,7	37,2		
19	R2	19,3	0	47	L2	71,2	37,2		
20	R1	19,3	2,8	48	L2	71,2	34,7		
21	DC+	12,3	0	49	L2	71,2	32,2		
22	DC+	9,8	0	50	L3	71,2	25,2		
23	DC+	12,3	2,8	51	L3	71,2	22,7		
24	DC+	9,8	2,8	52	L3	71,2	20,2		
25	E	2,8	0	53	BrC	71,2	12,8		
26	DC-	0	0	54	BrC	68,7	12,8		
27	G	2,8	2,8	55	BrG	71,2	5,6		
28	DC-	0	2,8	56	BrE	71,2	2,8		

Technical drawings showing side views and a top view of the component. Dimensions include pin diameter (φ 14,05), pin height (20,15), and various pin positions. The top view shows a rectangular component with dimensions 35,6 and 18,6. A note indicates: "Tolerance of positions: ±0,05mm of the end of pins. Dimension of coordinate axis is only offset without tolerance."

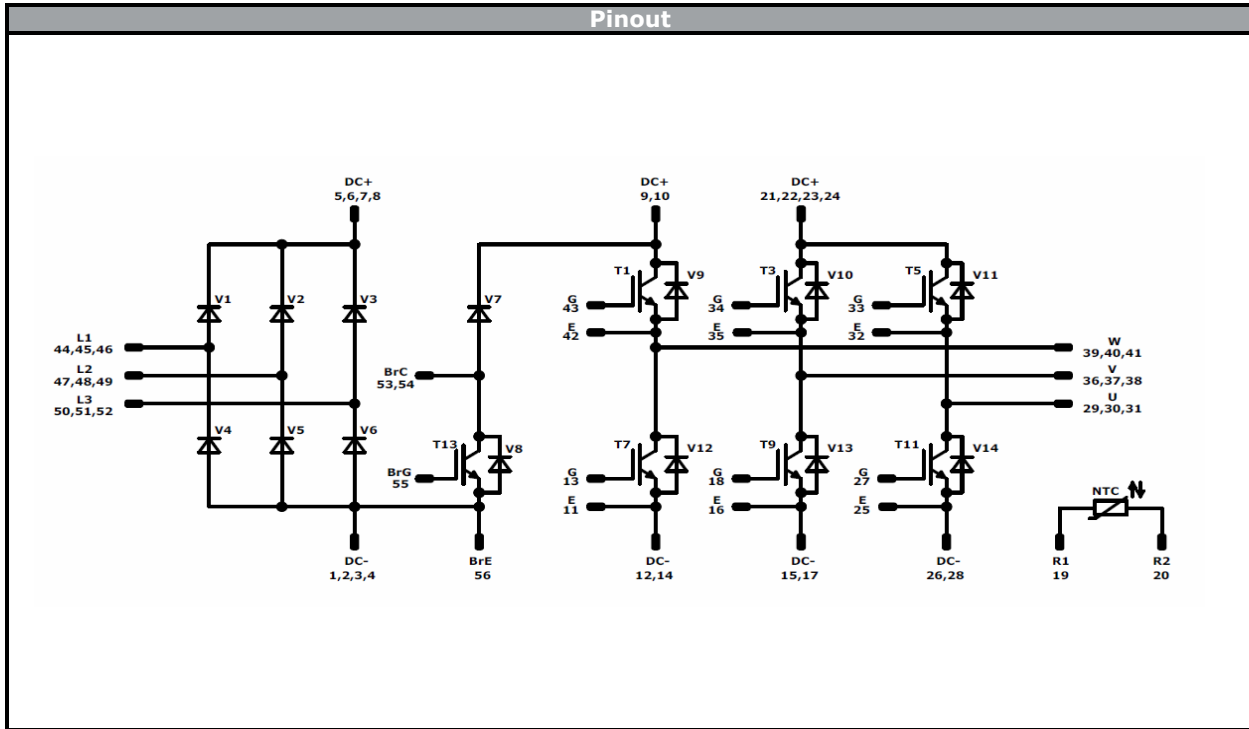

Identification					
ID	Component	Voltage	Current	Function	Comment
T1,T3,T5,T7,T9,T11	IGBT	600 V	75 A	Inverter Switch	
V9-V14	FWD	600 V	75 A	Inverter Diode	
V1-V6	Rectifier	1600 V	75 A	Rectifier Diode	
T13	IGBT	600 V	50 A	Brake Switch	
V7	FWD	600 V	20 A	Brake Diode	
V8	FWD	600 V	20 A	Brake Inverse Diode	
NTC	NTC			Thermistor	



Packaging instruction			
Standard packaging quantity (SPQ)	36	>SPQ Standard	<SPQ Sample

Handling instruction
Handling instructions for <i>flow 2</i> packages see vincotech.com website.

Package data
Package data for <i>flow 2</i> packages see vincotech.com website.

UL recognition and file number
This device is certified according to UL 1557 standard, UL file number E192116. For more information see vincotech.com website. 

Document No.:	Date:	Modification:	Pages
V23990-P764-Ax-D7-14	22 Jan. 2018	Updated R_{th} with Phase-change Material	

DISCLAIMER

The information, specifications, procedures, methods and recommendations herein (together "information") are presented by Vincotech to reader in good faith, are believed to be accurate and reliable, but may well be incomplete and/or not applicable to all conditions or situations that may exist or occur. Vincotech reserves the right to make any changes without further notice to any products to improve reliability, function or design. No representation, guarantee or warranty is made to reader as to the accuracy, reliability or completeness of said information or that the application or use of any of the same will avoid hazards, accidents, losses, damages or injury of any kind to persons or property or that the same will not infringe third parties rights or give desired results. It is reader's sole responsibility to test and determine the suitability of the information and the product for reader's intended use.

LIFE SUPPORT POLICY

Vincotech products are not authorised for use as critical components in life support devices or systems without the express written approval of Vincotech.

As used herein:

1. Life support devices or systems are devices or systems which, (a) are intended for surgical implant into the body, or (b) support or sustain life, or (c) whose failure to perform when properly used in accordance with instructions for use provided in labelling can be reasonably expected to result in significant injury to the user.
2. A critical component is any component of a life support device or system whose failure to perform can be reasonably expected to cause the failure of the life support device or system, or to affect its safety or effectiveness.