

flow90PACK 1 2nd gen

1200V/35A

Features

- Trench Fieldstop IGBT4 Technology
- Supports designs with 90° mounting angle between heatsink and PCB
- Clip-in PCB mounting
- Clip or screw hetasink mounting

Target Applications

- Motor Drives

Types

- V23990-P700-F40-PM

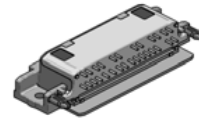
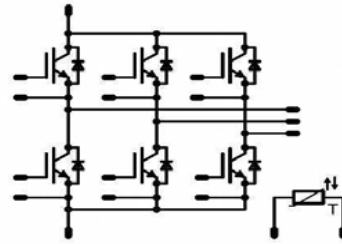
flow90PACK 1 2nd gen

Schematic

Maximum Ratings

 $T_j=25^{\circ}\text{C}$, unless otherwise specified

Parameter	Symbol	Condition	Value	Unit
Inverter IGBT				
Collector-emitter break down voltage	V_{CE}		1200	V
DC collector current	I_C	$T_j=T_{jmax}$ $T_h=80^{\circ}\text{C}$ $T_c=80^{\circ}\text{C}$	35 46	A
Repetitive peak collector current	I_{Cpulse}	t_p limited by T_{jmax}	105	A
Turn off safe operating area		$V_{CE} \leq 1200\text{V}$, $T_j \leq T_{op max}$	105	A
Power dissipation per IGBT	P_{tot}	$T_j=T_{jmax}$ $T_h=80^{\circ}\text{C}$ $T_c=80^{\circ}\text{C}$	85 128	W
Gate-emitter peak voltage	V_{GE}		± 20	V
Short circuit ratings	t_{SC} V_{CC}	$T_j \leq 150^{\circ}\text{C}$ $V_{GE}=15\text{V}$	10 800	μs V
Maximum Junction Temperature	T_{jmax}		175	$^{\circ}\text{C}$

Inverter FWD

Peak Repetitive Reverse Voltage	V_{RRM}	$T_j=25^{\circ}\text{C}$	1200	V
DC forward current	I_F	$T_j=T_{jmax}$ $T_h=80^{\circ}\text{C}$ $T_c=80^{\circ}\text{C}$	31 41	A
Repetitive peak forward current	I_{FRM}	t_p limited by T_{jmax}	70	A
Power dissipation per Diode	P_{tot}	$T_j=T_{jmax}$ $T_h=80^{\circ}\text{C}$ $T_c=80^{\circ}\text{C}$	58 89	W
Maximum Junction Temperature	T_{jmax}		175	$^{\circ}\text{C}$

Maximum Ratings

 $T_j=25^{\circ}\text{C}$, unless otherwise specified

Parameter	Symbol	Condition	Value	Unit
-----------	--------	-----------	-------	------

Thermal Properties

Storage temperature	T_{stg}		-40...+125	$^{\circ}\text{C}$
Operation temperature under switching condition	T_{op}		-40...+(T_{jmax} - 25)	$^{\circ}\text{C}$

Insulation Properties

Insulation voltage	V_{is}	t=2s DC voltage	4000	V
Creepage distance			min 12,7	mm
Clearance			min 12,7	mm
Comparative tracking index	CTI		>200	

Characteristic Values

Parameter	Symbol	Conditions					Value			Unit
		$V_{GE}[V]$ or $V_{GS}[V]$	$V_r[V]$ or $V_{CE}[V]$ or $V_{DS}[V]$	$I_c[A]$ or $I_F[A]$ or $I_b[A]$	T_j	Min	Typ	Max		
Inverter IGBT										
Gate emitter threshold voltage	$V_{GE(th)}$	$V_{CE}=V_{GE}$			0,0012	$T_j=25^{\circ}C$ $T_j=150^{\circ}C$	5	5,8	6,5	V
Collector-emitter saturation voltage	$V_{CE(sat)}$		15		35	$T_j=25^{\circ}C$ $T_j=150^{\circ}C$	1,3	1,96 2,28	2,5	V
Collector-emitter cut-off current incl. Diode	I_{CES}		0	1200		$T_j=25^{\circ}C$ $T_j=150^{\circ}C$			0,01	mA
Gate-emitter leakage current	I_{GES}		20	0		$T_j=25^{\circ}C$ $T_j=150^{\circ}C$			600	nA
Integrated Gate resistor	R_{gint}							none		Ω
Turn-on delay time	$t_{d(on)}$	Rgoff=16 Ω Rgon=16 Ω	± 15	300	35	$T_j=25^{\circ}C$		95		ns
Rise time	t_r					$T_j=150^{\circ}C$		104		
Turn-off delay time	$t_{d(off)}$					$T_j=25^{\circ}C$		24		
Fall time	t_f					$T_j=150^{\circ}C$		26		
Turn-on energy loss per pulse	E_{on}					$T_j=25^{\circ}C$		204		
Turn-off energy loss per pulse	E_{off}					$T_j=150^{\circ}C$		273		
Input capacitance	C_{ies}									
Output capacitance	C_{oss}	f=1MHz	0	25		$T_j=25^{\circ}C$		155		pF
Reverse transfer capacitance	C_{rss}							115		pF
Gate charge	Q_{Gate}		± 15	960	35	$T_j=25^{\circ}C$		200		nC
Thermal resistance chip to heatsink per chip	R_{thJH}	Thermal grease thickness $\leq 50\mu m$ $\lambda = 1 W/mK$						1,12		K/W
Inverter FWD										
Diode forward voltage	V_F				35	$T_j=25^{\circ}C$ $T_j=150^{\circ}C$	1,4	1,77 1,74	2,3	V
Peak reverse recovery current	I_{RRM}	Rgon=16 Ω	± 15	300	35	$T_j=25^{\circ}C$		39		A
Reverse recovery time	t_{rr}					$T_j=150^{\circ}C$		46		
Reverse recovered charge	Q_{rr}					$T_j=25^{\circ}C$		245		
Peak rate of fall of recovery current	$di(rec)max/dt$					$T_j=150^{\circ}C$		403		
Reverse recovered energy	E_{rec}					$T_j=25^{\circ}C$		3,24		
						$T_j=150^{\circ}C$		6,46		
Thermal resistance chip to heatsink per chip	R_{thJH}	Thermal grease thickness $\leq 50\mu m$ $\lambda = 1 W/mK$						1,63		K/W
Thermistor										
Rated resistance	R					T=25 $^{\circ}C$		22000		Ω
Deviation of R100	$\Delta R/R$	R100=1486 Ω				T=100 $^{\circ}C$	-5		5	%
Power dissipation	P					T=25 $^{\circ}C$		200		mW
Power dissipation constant						T=25 $^{\circ}C$		2		mW/K
B-value	$B_{(25/50)}$	Tol. $\pm 3\%$				T=25 $^{\circ}C$		3950		K
B-value	$B_{(25/100)}$	Tol. $\pm 3\%$				T=25 $^{\circ}C$		3996		K
Vincotech NTC Reference									B	

Output Inverter

Figure 1 Output inverter IGBT

Typical output characteristics

$I_C = f(V_{CE})$

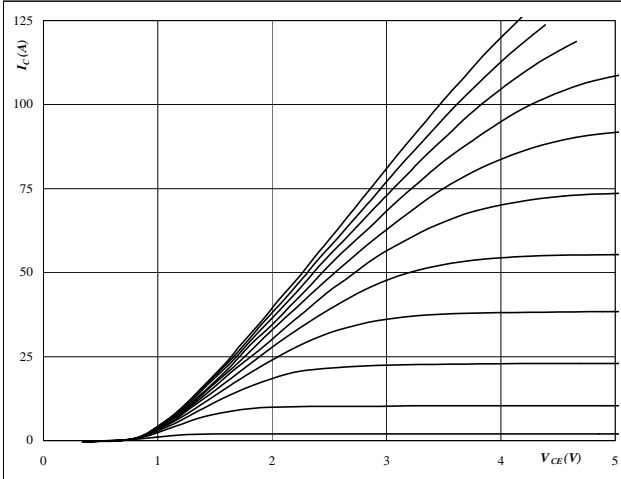

At
 $t_p = 250 \mu s$
 $T_j = 25 \text{ } ^\circ C$
 V_{GE} from 7 V to 17 V in steps of 1 V

Figure 2 Output inverter IGBT

Typical output characteristics

$I_C = f(V_{CE})$

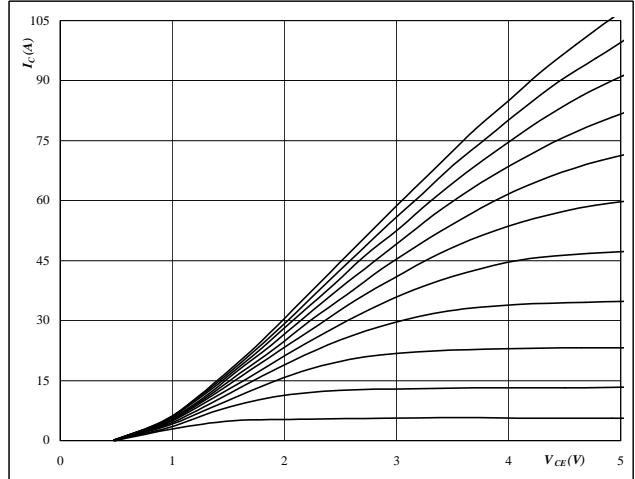

At
 $t_p = 250 \mu s$
 $T_j = 150 \text{ } ^\circ C$
 V_{GE} from 7 V to 17 V in steps of 1 V

Figure 3 Output inverter IGBT

Typical transfer characteristics

$I_C = f(V_{GE})$

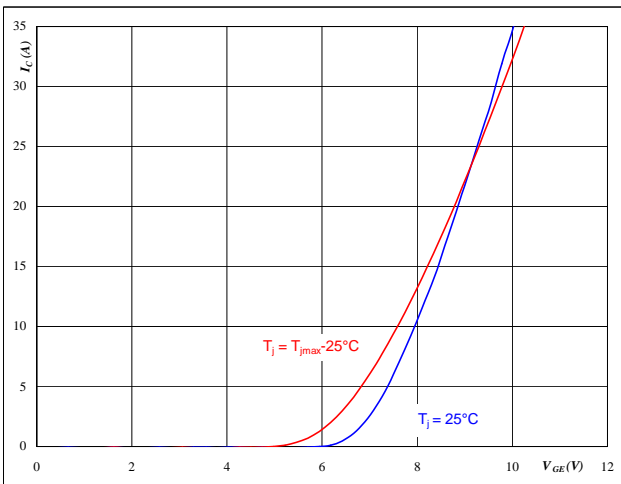

At
 $t_p = 250 \mu s$
 $V_{CE} = 10 \text{ V}$

Figure 4 Output inverter FWD

Typical diode forward current as a function of forward voltage

$I_F = f(V_F)$

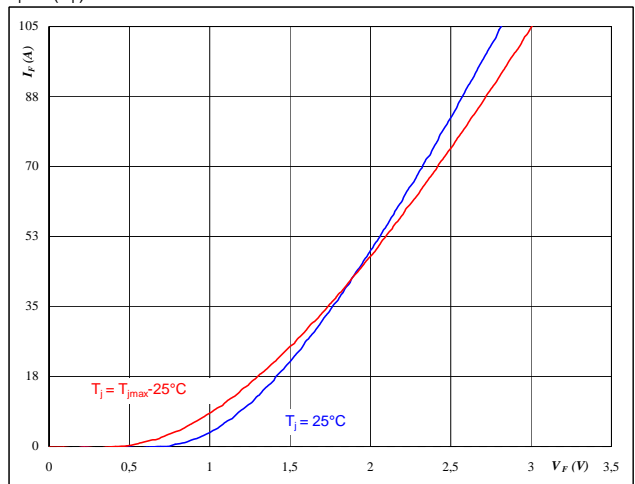

At
 $t_p = 250 \mu s$

Output Inverter

Figure 5 Output inverter IGBT

Typical switching energy losses as a function of collector current

$$E = f(I_C)$$

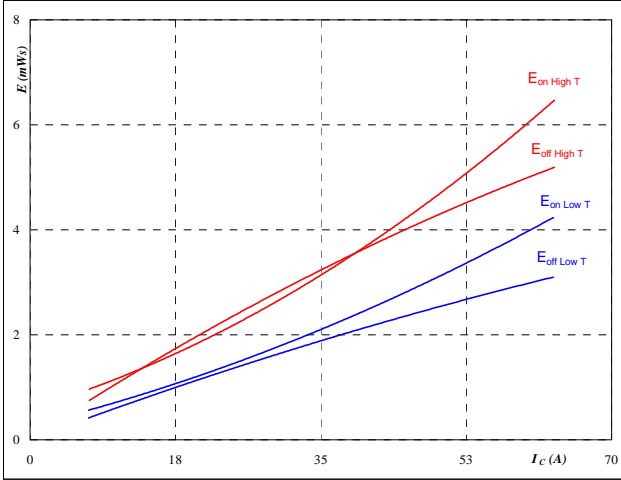

With an inductive load at

$T_J =$	25/150	°C
$V_{CE} =$	600	V
$V_{GE} =$	±15	V
$R_{gon} =$	16	Ω
$R_{goff} =$	16	Ω

Figure 6 Output inverter IGBT

Typical switching energy losses as a function of gate resistor

$$E = f(R_G)$$

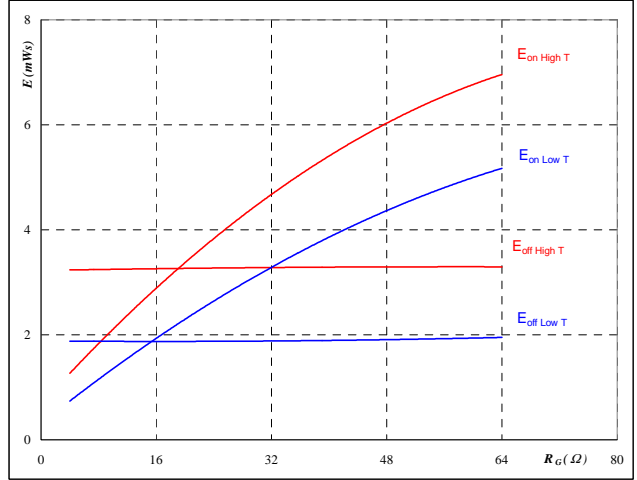

With an inductive load at

$T_J =$	25/150	°C
$V_{CE} =$	600	V
$V_{GE} =$	±15	V
$I_C =$	35	A

Figure 7 Output inverter FWD

Typical reverse recovery energy loss as a function of collector current

$$E_{rec} = f(I_C)$$

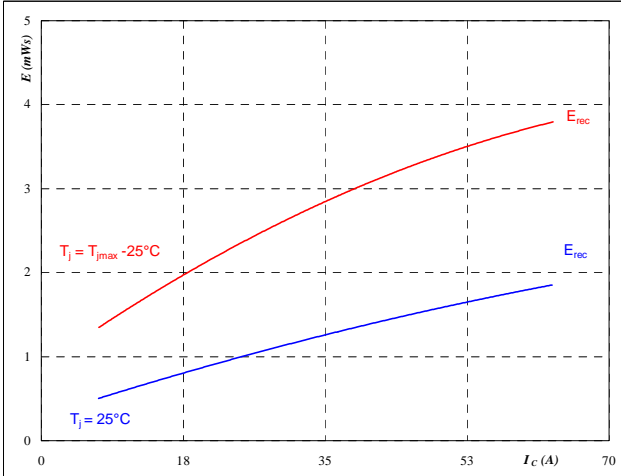

With an inductive load at

$T_J =$	25/150	°C
$V_{CE} =$	600	V
$V_{GE} =$	±15	V
$R_{gon} =$	16	Ω

Figure 8 Output inverter FWD

Typical reverse recovery energy loss as a function of gate resistor

$$E_{rec} = f(R_G)$$

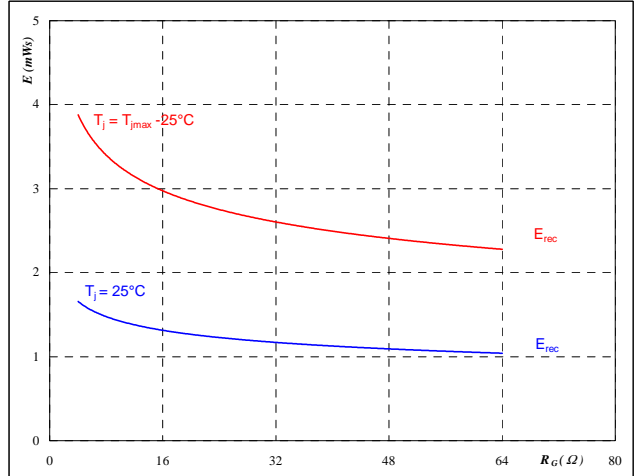

With an inductive load at

$T_J =$	25/150	°C
$V_{CE} =$	600	V
$V_{GE} =$	±15	V
$I_C =$	35	A

Output Inverter

Figure 9 Output inverter IGBT

Typical switching times as a function of collector current

$t = f(I_C)$

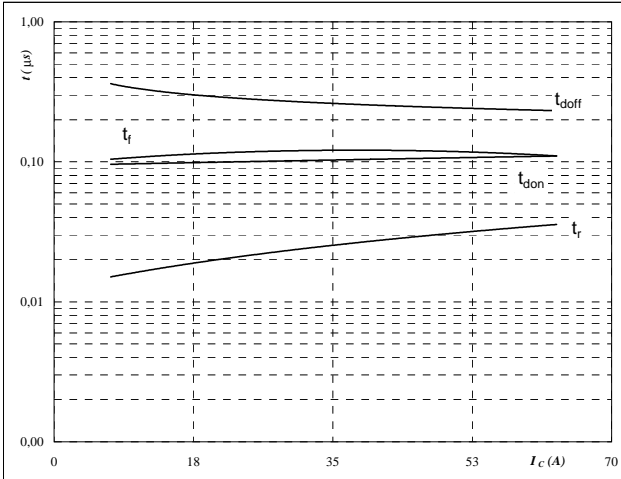

With an inductive load at

$T_j =$	150	°C
$V_{CE} =$	600	V
$V_{GE} =$	±15	V
$R_{gon} =$	16	Ω
$R_{goff} =$	16	Ω

Figure 10 Output inverter IGBT

Typical switching times as a function of gate resistor

$t = f(R_G)$

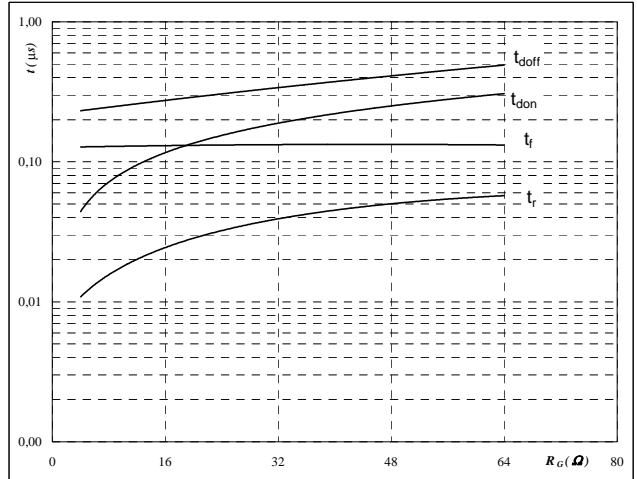

With an inductive load at

$T_j =$	150	°C
$V_{CE} =$	600	V
$V_{GE} =$	±15	V
$I_C =$	35	A

Figure 11 Output inverter FWD

Typical reverse recovery time as a function of collector current

$t_{rr} = f(I_C)$

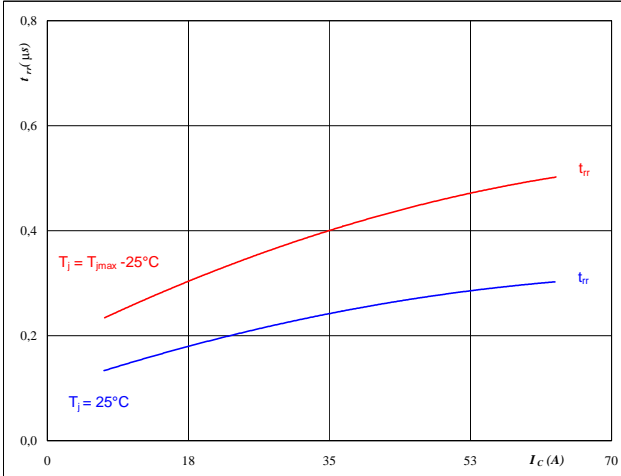

At

$T_j =$	25/150	°C
$V_{CE} =$	600	V
$V_{GE} =$	±15	V
$R_{gon} =$	16	Ω

Figure 12 Output inverter FWD

Typical reverse recovery time as a function of IGBT turn on gate resistor

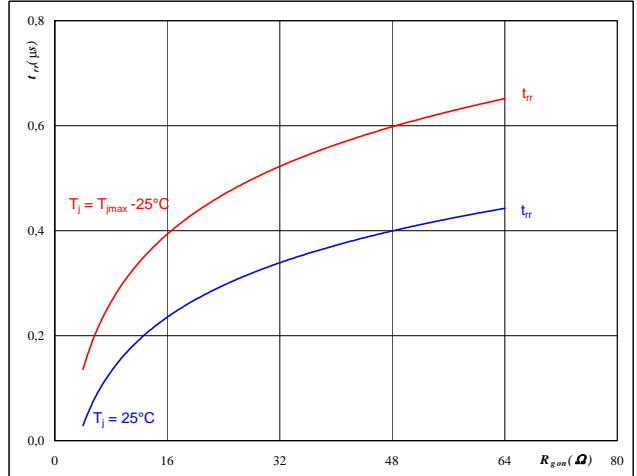
$t_{rr} = f(R_{gon})$

At

$T_j =$	25/150	°C
$V_R =$	600	V
$I_F =$	35	A
$V_{GE} =$	±15	V

Output Inverter

Figure 13 Output inverter FWD

Typical reverse recovery charge as a function of collector current

$$Q_{rr} = f(I_c)$$

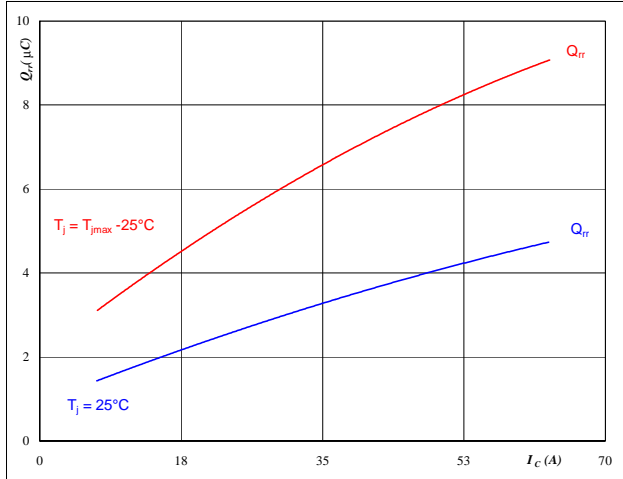

At

$T_j =$	25/150	°C
$V_{CE} =$	600	V
$V_{GE} =$	±15	V
$R_{gon} =$	16	Ω

Figure 14 Output inverter FWD

Typical reverse recovery charge as a function of IGBT turn on gate resistor

$$Q_{rr} = f(R_{gon})$$

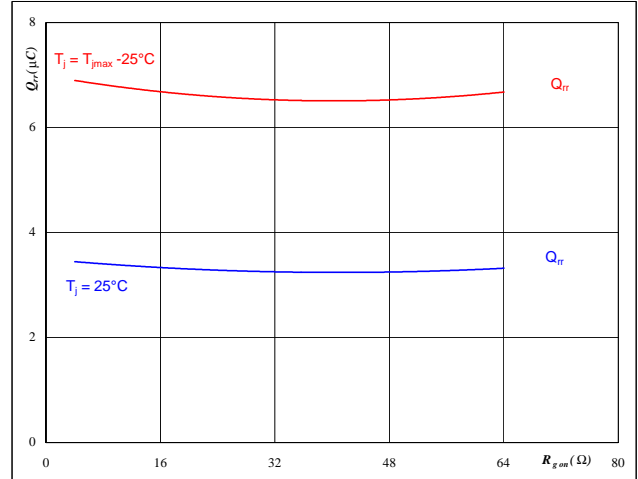

At

$T_j =$	25/150	°C
$V_R =$	600	V
$I_F =$	35	A
$V_{GE} =$	±15	V

Figure 15 Output inverter FWD

Typical reverse recovery current as a function of collector current

$$I_{RRM} = f(I_c)$$

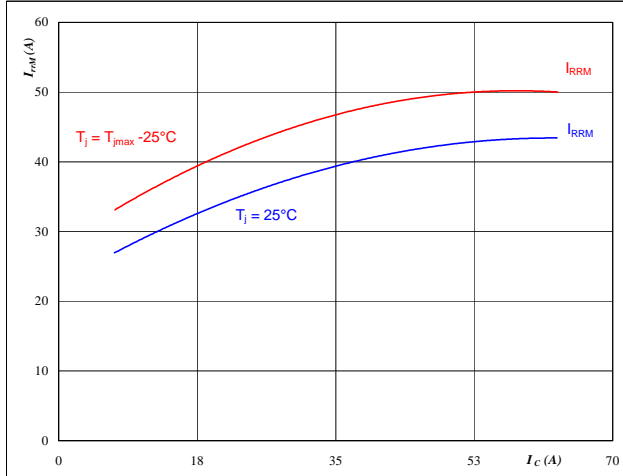

At

$T_j =$	25/150	°C
$V_{CE} =$	600	V
$V_{GE} =$	±15	V
$R_{gon} =$	16	Ω

Figure 16 Output inverter FWD

Typical reverse recovery current as a function of IGBT turn on gate resistor

$$I_{RRM} = f(R_{gon})$$

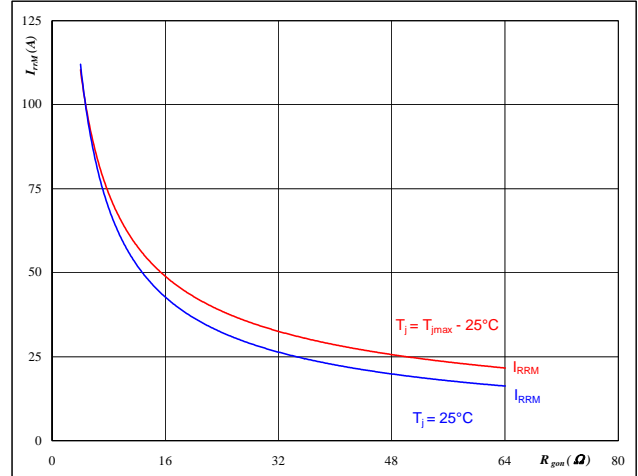

At

$T_j =$	25/150	°C
$V_R =$	600	V
$I_F =$	35	A
$V_{GE} =$	±15	V

Output Inverter

Figure 17 Output inverter FWD

Typical rate of fall of forward and reverse recovery current as a function of collector current

$$dI_o/dt, dI_{rec}/dt = f(I_C)$$

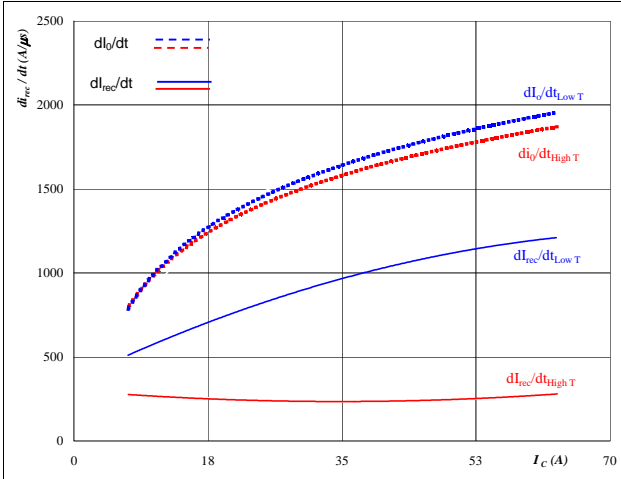

At
 $T_j = 25/150$ °C
 $V_{CE} = 600$ V
 $V_{GE} = \pm 15$ V
 $R_{gon} = 16$ Ω

Figure 18 Output inverter FWD

Typical rate of fall of forward and reverse recovery current as a function of IGBT turn on gate resistor

$$dI_o/dt, dI_{rec}/dt = f(R_{gon})$$

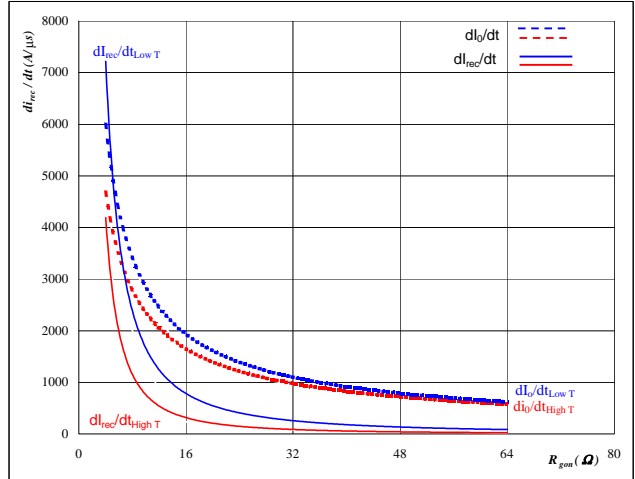

At
 $T_j = 25/150$ °C
 $V_R = 600$ V
 $I_F = 35$ A
 $V_{GE} = \pm 15$ V

Figure 19 Output inverter IGBT

IGBT transient thermal impedance as a function of pulse width

$$Z_{thJH} = f(t_p)$$

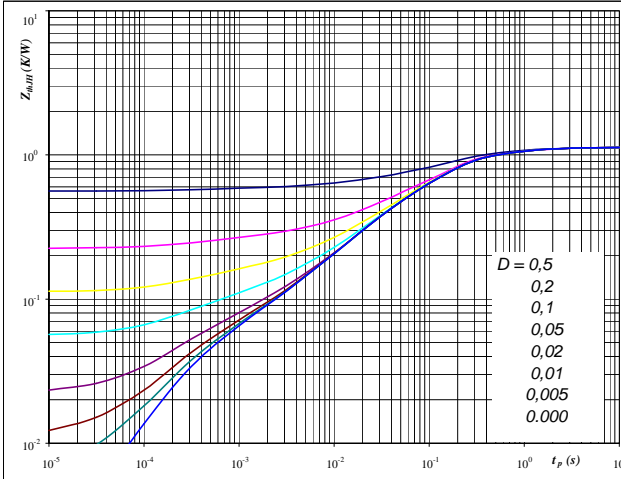

At
 $D = t_p / T$
 $R_{thJH} = 1,12$ K/W $R_{thJC} = 0,91$

IGBT thermal model values

Thermal grease		Phase change interface	
R (C/W)	Tau (s)	R (C/W)	Tau (s)
0,17	1,0E+00	0,14	8,4E-01
0,66	1,5E-01	0,53	1,2E-01
0,21	2,3E-02	0,17	1,8E-02
0,05	2,8E-03	0,04	2,3E-03
0,04	3,1E-04	0,03	2,5E-04

Figure 20 Output inverter FWD

FWD transient thermal impedance as a function of pulse width

$$Z_{thJH} = f(t_p)$$

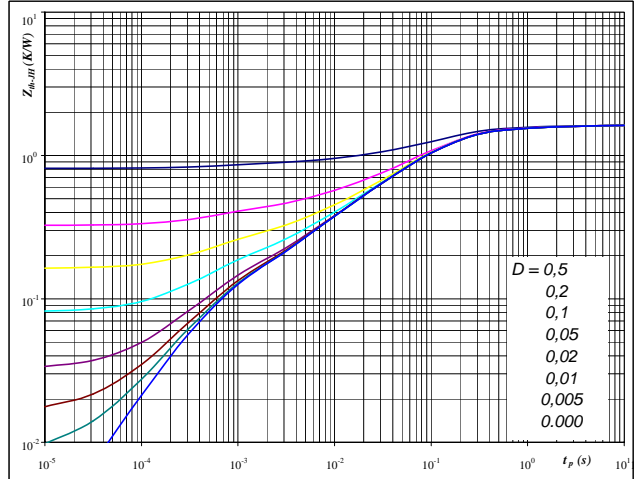

At
 $D = t_p / T$
 $R_{thJH} = 1,63$ K/W $R_{thJC} = 1,32$

FWD thermal model values

Thermal grease		Phase change interface	
R (C/W)	Tau (s)	R (C/W)	Tau (s)
0,05	5,1E+00	0,04	4,1E+00
0,14	8,0E-01	0,12	6,5E-01
0,85	1,3E-01	0,69	1,1E-01
0,33	3,4E-02	0,27	2,7E-02
0,15	6,2E-03	0,12	5,0E-03
0,10	5,5E-04	0,08	4,5E-04

Output Inverter

Figure 21 Output inverter IGBT

Power dissipation as a function of heatsink temperature

$$P_{tot} = f(T_h)$$



At
 T_j = 175 °C

Figure 22 Output inverter IGBT

Collector current as a function of heatsink temperature

$$I_C = f(T_h)$$

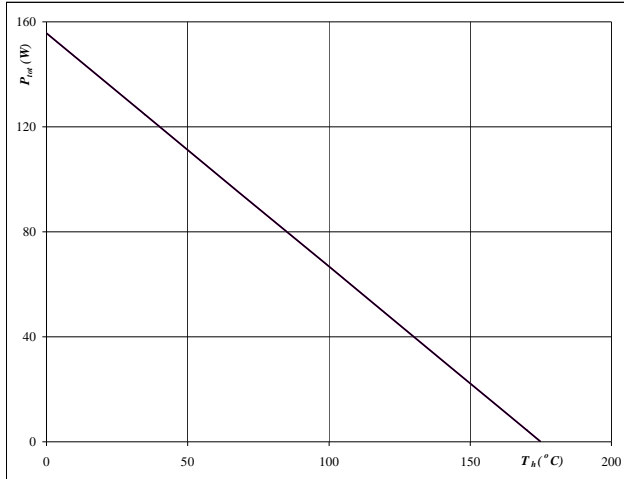

At
 T_j = 175 °C
 V_{GE} = 15 V

Figure 23 Output inverter FWD

Power dissipation as a function of heatsink temperature

$$P_{tot} = f(T_h)$$

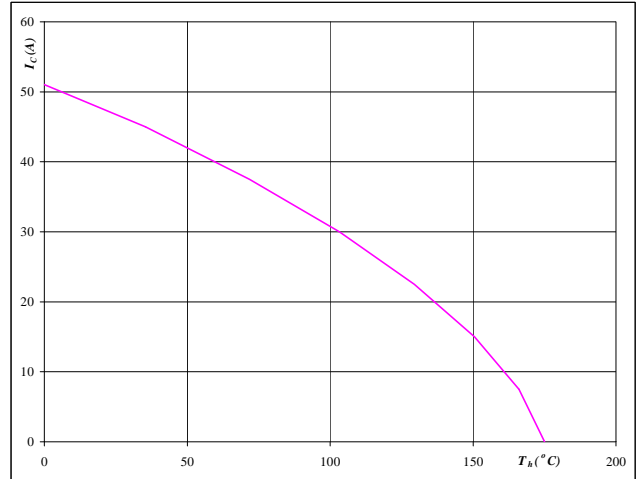

At
 T_j = 175 °C

Figure 24 Output inverter FWD

Forward current as a function of heatsink temperature

$$I_F = f(T_h)$$

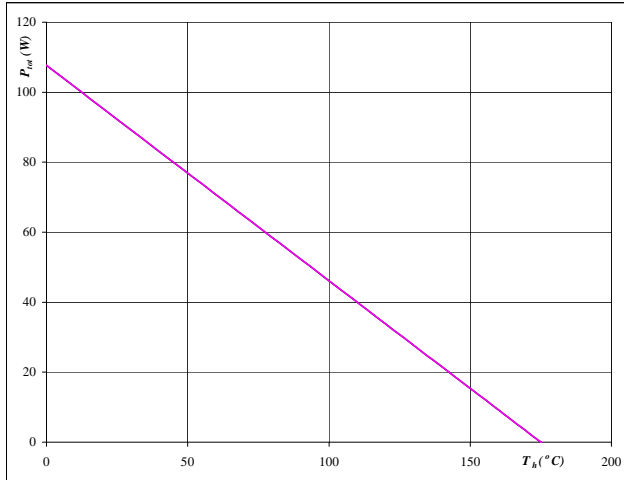
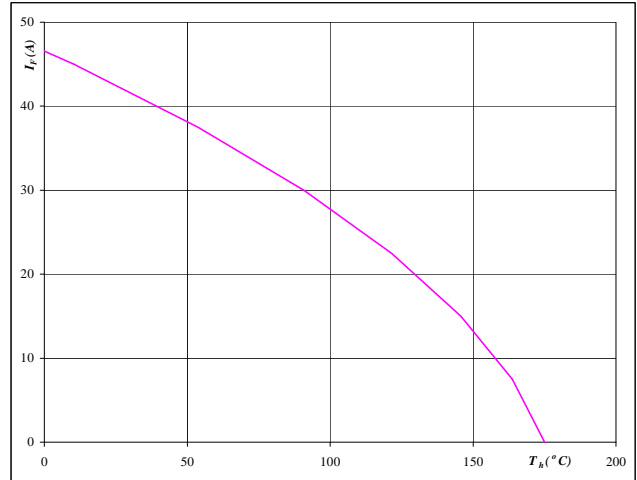
At
 T_j = 175 °C

Output Inverter

Figure 25 Output inverter IGBT

Safe operating area as a function of collector-emitter voltage
 $I_C = f(V_{CE})$

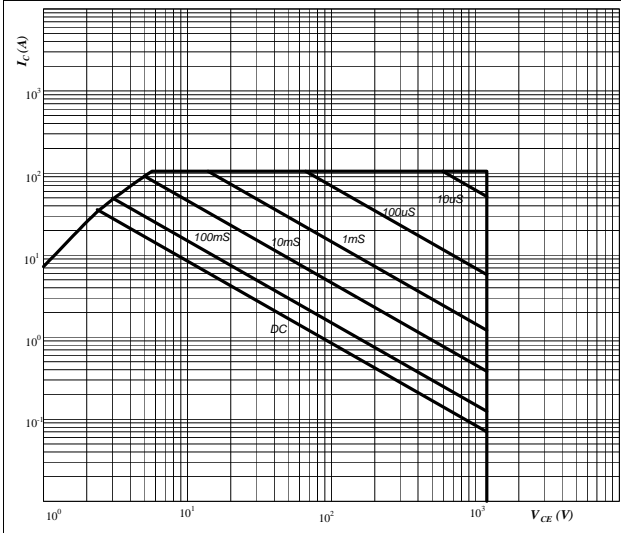

At
 D = single pulse
 $T_h = 80$ °C
 $V_{GE} = \pm 15$ V
 $T_j = T_{jmax}$ °C

Figure 26 Output inverter IGBT

Gate voltage vs Gate charge

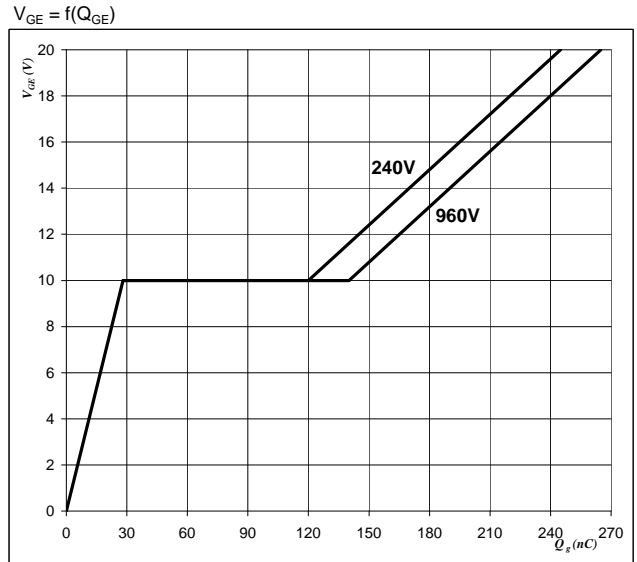

At
 $I_C = 35$ A

Figure 27 Output inverter IGBT

Short circuit withstand time as a function of gate-emitter voltage
 $t_{sc} = f(V_{GE})$

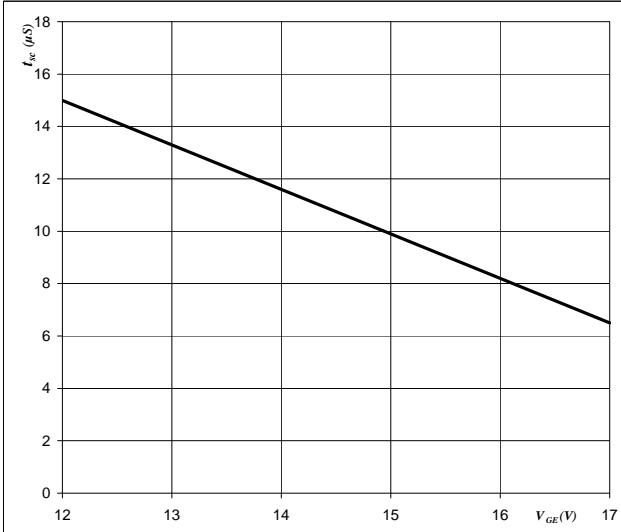

At
 $V_{CE} = 1200$ V
 $T_j \leq 175$ °C

Figure 28 Output inverter IGBT

Typical short circuit collector current as a function of gate-emitter voltage
 $V_{GE} = f(Q_{GE})$

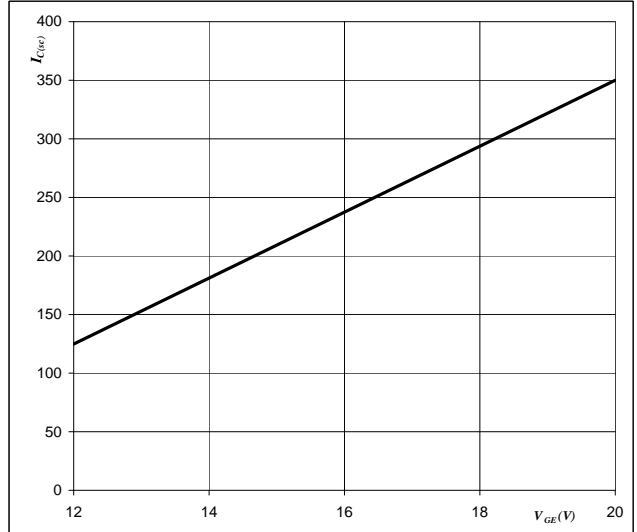

At
 $V_{CE} \leq 1200$ V
 $T_j = 175$ °C

Figure 29 IGBT

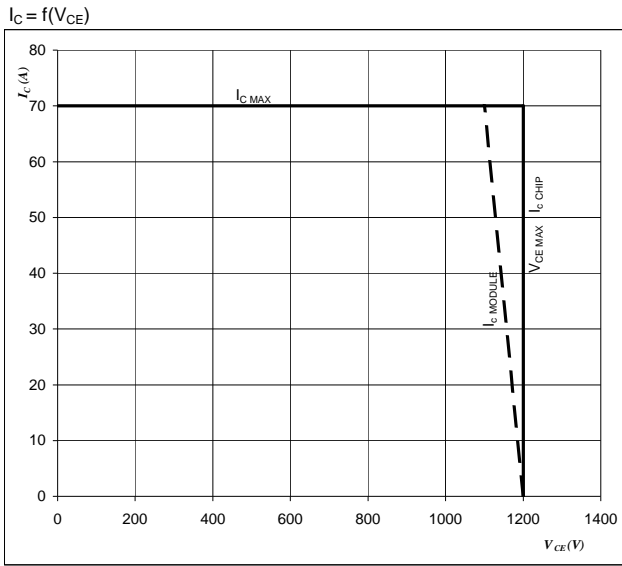
Reverse bias safe operating area

At

$$T_j = T_{j\ max} - 25 \quad ^\circ\text{C}$$

$$U_{oc\ minus} = U_{cc\ plus}$$

Switching mode : 3phase SPWM

Thermistor

Figure 1 Thermistor

Typical NTC characteristic
 as a function of temperature

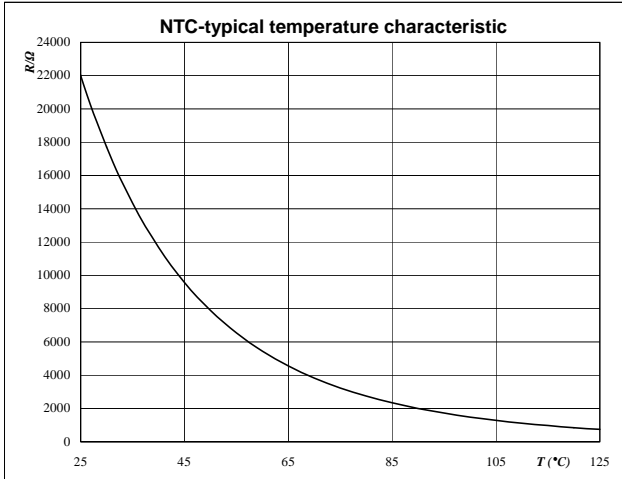
 $R_T = f(T)$

Figure 2 Thermistor

Typical NTC resistance values

$$R(T) = R_{25} \cdot e^{\left(B_{25/100} \left(\frac{1}{T} - \frac{1}{T_{25}} \right) \right)} \quad [\Omega]$$

Switching Definitions Output Inverter

General conditions	
T_j	= 150 °C
R_{gon}	= 16 Ω
R_{goff}	= 16 Ω

Figure 1 Output inverter IGBT

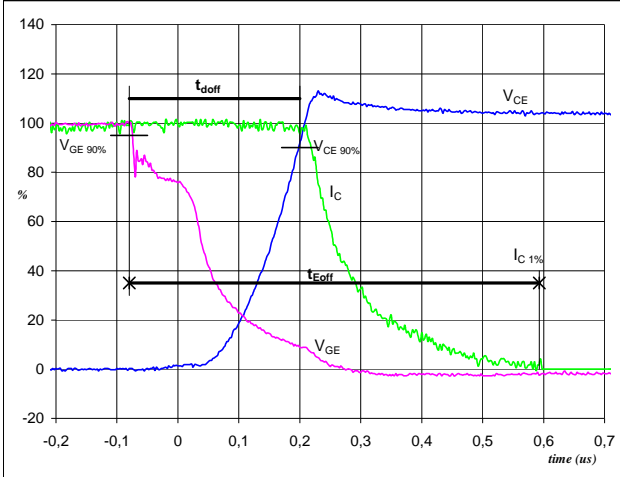
Turn-off Switching Waveforms & definition of t_{doff} , t_{Eoff}
 (t_{Eoff} = integrating time for E_{off})

V_{GE} (0%) =	-15	V
V_{GE} (100%) =	15	V
V_C (100%) =	600	V
I_C (100%) =	35	A
t_{doff} =	0,27	μ s
t_{Eoff} =	0,67	μ s

Figure 2 Output inverter IGBT

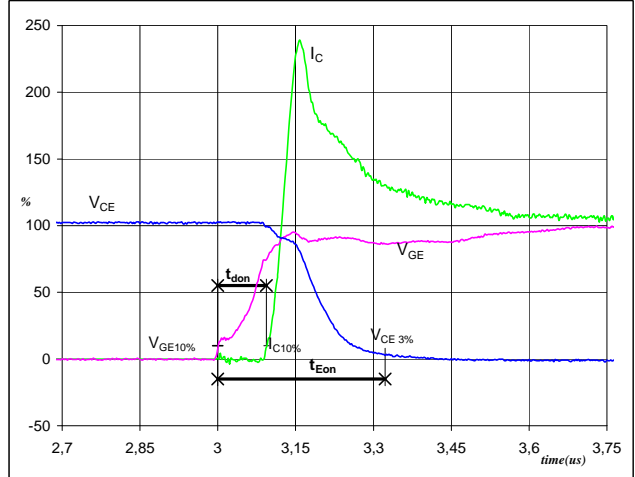
Turn-on Switching Waveforms & definition of t_{don} , t_{Eon}
 (t_{Eon} = integrating time for E_{on})

V_{GE} (0%) =	-15	V
V_{GE} (100%) =	15	V
V_C (100%) =	600	V
I_C (100%) =	35	A
t_{don} =	0,10	μ s
t_{Eon} =	0,32	μ s

Figure 3 Output inverter IGBT

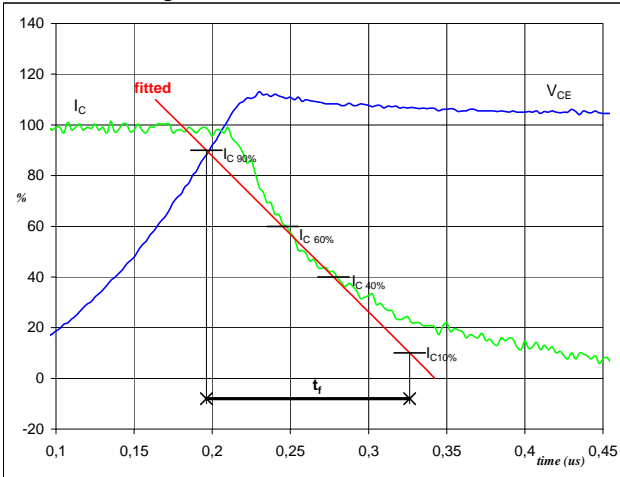
Turn-off Switching Waveforms & definition of t_f

V_C (100%) =	600	V
I_C (100%) =	35	A
t_f =	0,13	μ s

Figure 4 Output inverter IGBT

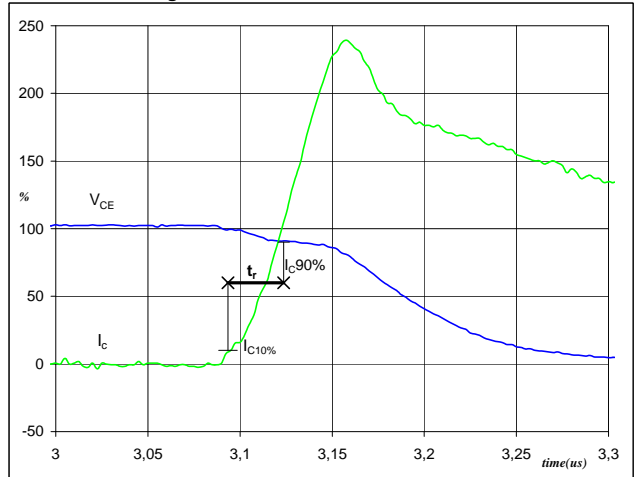
Turn-on Switching Waveforms & definition of t_r

V_C (100%) =	600	V
I_C (100%) =	35	A
t_r =	0,03	μ s

Switching Definitions Output Inverter

Figure 5 Output inverter IGBT

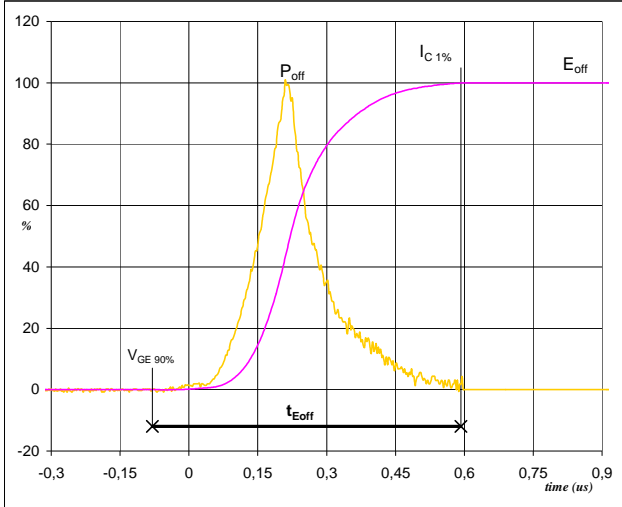
Turn-off Switching Waveforms & definition of t_{Eoff}

$P_{off} (100\%) = 21,02 \text{ kW}$
 $E_{off} (100\%) = 3,24 \text{ mJ}$
 $t_{Eoff} = 0,67 \text{ } \mu\text{s}$

Figure 6 Output inverter IGBT

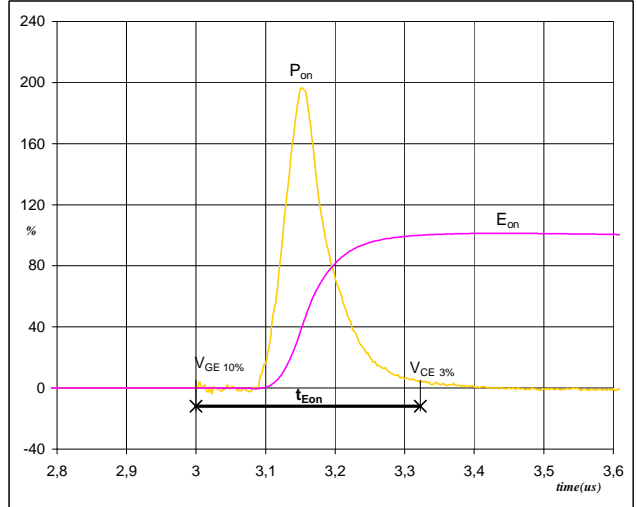
Turn-on Switching Waveforms & definition of t_{Eon}

$P_{on} (100\%) = 21,02 \text{ kW}$
 $E_{on} (100\%) = 3,13 \text{ mJ}$
 $t_{Eon} = 0,32 \text{ } \mu\text{s}$

Figure 7 Output inverter FWD

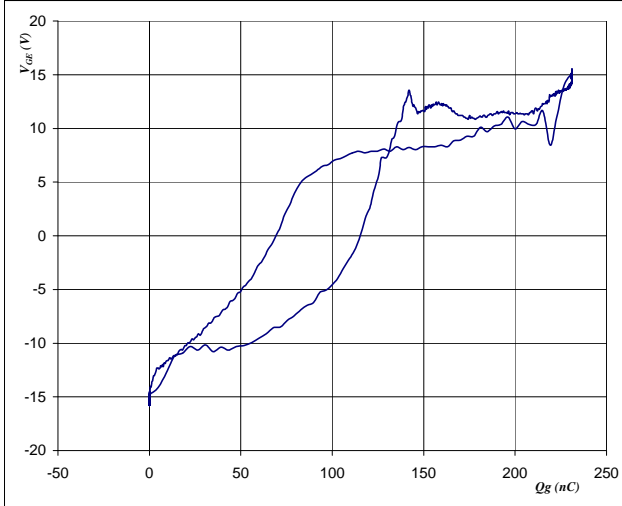
Gate voltage vs Gate charge (measured)

$V_{GEoff} = -15 \text{ V}$
 $V_{GEon} = 15 \text{ V}$
 $V_C (100\%) = 600 \text{ V}$
 $I_C (100\%) = 35 \text{ A}$
 $Q_g = 231,03 \text{ nC}$

Figure 8 Output inverter IGBT

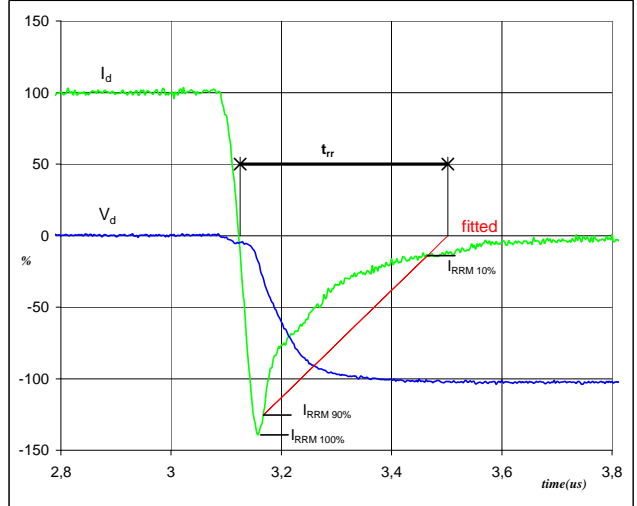
Turn-off Switching Waveforms & definition of t_{rr}

$V_d (100\%) = 600 \text{ V}$
 $I_d (100\%) = 35 \text{ A}$
 $I_{RRM} (100\%) = -46 \text{ A}$
 $t_{rr} = 0,40 \text{ } \mu\text{s}$

Switching Definitions Output Inverter

Figure 9 Output inverter FWD

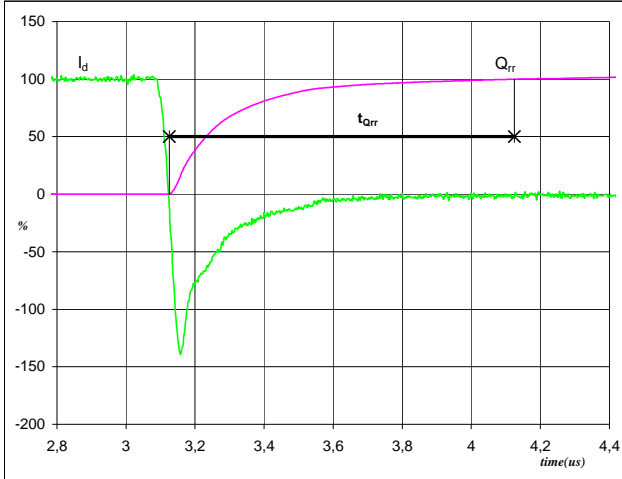
Turn-on Switching Waveforms & definition of t_{Qrr}
 (t_{Qrr} = integrating time for Q_{rr})

I_d (100%) =	35	A
Q_{rr} (100%) =	6,46	μC
t_{Qrr} =	1,00	μs

Figure 10 Output inverter FWD

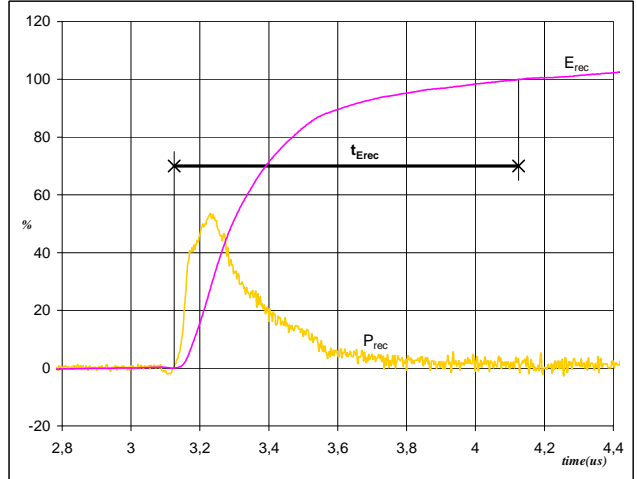
Turn-on Switching Waveforms & definition of t_{Erec}
 (t_{Erec} = integrating time for E_{rec})

P_{rec} (100%) =	21,02	kW
E_{rec} (100%) =	2,79	mJ
t_{Erec} =	1,00	μs

Ordering Code and Marking - Outline - Pinout
Ordering Code & Marking

Version	Ordering Code	in DataMatrix as	in packaging barcode as
without thermal paste 12mm housing	V23990-P700-F40	P700-F40	P700-F40

Outline

Pin Table		
Pin	X	Y
1	53	0
2	50	0
3	43	0
4	40	0
5	37	0
6	34,1	0
7	31	0
8	28,1	0
9	24,05	0
10	21,05	0
11	17	0
12	12,95	0
13	8,9	0
14	6	0
15	3	0
16	0	0
17	0	7
18	3	7
19	7,2	7
20	10,2	7
21	17,2	7
22	20,2	7
23	29,75	7
24	32,75	7
25	39,75	7
26	42,75	7

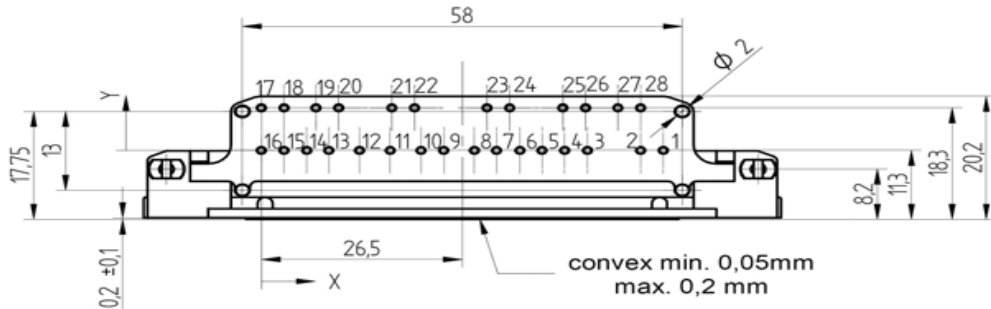

Pin Table		
Pin	X	Y
27	47	7
28	50	7

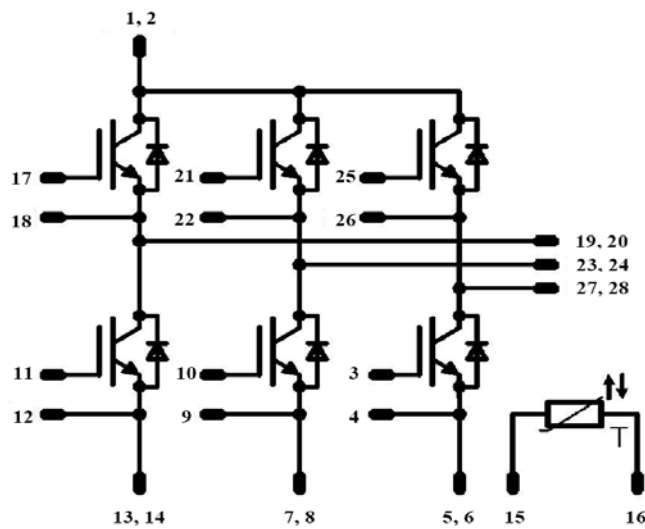
Pinout

PRODUCT STATUS DEFINITIONS

Datasheet Status	Product Status	Definition
Target	Formative or In Design	This datasheet contains the design specifications for product development. Specifications may change in any manner without notice. The data contained is exclusively intended for technically trained staff.
Preliminary	First Production	This datasheet contains preliminary data, and supplementary data may be published at a later date. Vincotech reserves the right to make changes at any time without notice in order to improve design. The data contained is exclusively intended for technically trained staff.
Final	Full Production	This datasheet contains final specifications. Vincotech reserves the right to make changes at any time without notice in order to improve design. The data contained is exclusively intended for technically trained staff.

DISCLAIMER

The information given in this datasheet describes the type of component and does not represent assured characteristics. For tested values please contact Vincotech. Vincotech reserves the right to make changes without further notice to any products herein to improve reliability, function or design. Vincotech does not assume any liability arising out of the application or use of any product or circuit described herein; neither does it convey any license under its patent rights, nor the rights of others.

LIFE SUPPORT POLICY

Vincotech products are not authorised for use as critical components in life support devices or systems without the express written approval of Vincotech.

As used herein:

1. Life support devices or systems are devices or systems which, (a) are intended for surgical implant into the body, or (b) support or sustain life, or (c) whose failure to perform when properly used in accordance with instructions for use provided in labelling can be reasonably expected to result in significant injury to the user.
2. A critical component is any component of a life support device or system whose failure to perform can be reasonably expected to cause the failure of the life support device or system, or to affect its safety or effectiveness.