

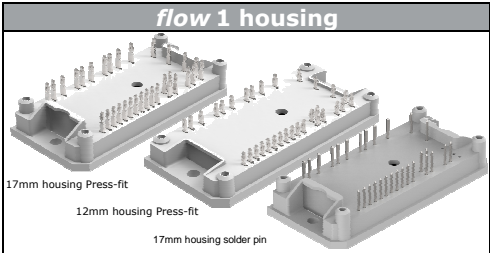
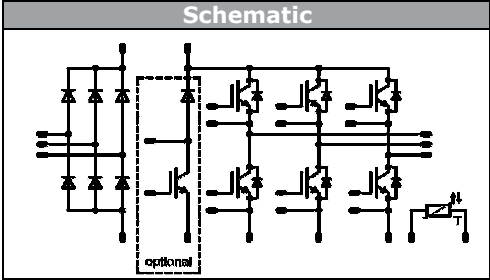

<i>flow</i> PIM 1	1200 V / 15 A
<div style="border: 1px solid black; padding: 5px; margin-bottom: 5px;"> <p style="text-align: center; margin: 0;">Features</p> <ul style="list-style-type: none"> 3~rectifier, optional BRC, Inverter, NTC Very compact housing, easy to route IGBT4 / EmCon4 technology for low saturation losses and improved EMC behaviour </div> <div style="border: 1px solid black; padding: 5px; margin-bottom: 5px;"> <p style="text-align: center; margin: 0;">Target Applications</p> <ul style="list-style-type: none"> Industrial drives Embedded drives </div> <div style="border: 1px solid black; padding: 5px;"> <p style="text-align: center; margin: 0;">Types</p> <ul style="list-style-type: none"> V23990-P588-A41-PM V23990-P588-A418-PM V23990-P588-C41-PM V23990-P588-C418-PM </div>	<div style="border: 1px solid black; padding: 5px; margin-bottom: 5px;"> <p style="text-align: center; margin: 0;">flow 1 housing</p>  </div> <div style="border: 1px solid black; padding: 5px;"> <p style="text-align: center; margin: 0;">Schematic</p>  </div>

Maximum Ratings

$T_j = 25\text{ }^\circ\text{C}$, unless otherwise specified

Parameter	Symbol	Condition	Value	Unit
Rectifier Diode				
Repetitive peak reverse voltage	V_{RRM}		1600	V
DC forward current	I_{FAV}	$T_j = T_{jmax}$ $T_s = 80\text{ }^\circ\text{C}$	42	A
Surge (non-repetitive) forward current	I_{FSM}	$t_p = 10\text{ ms}$ 50Hz half sine wave	280	A
I2t-value	I^2t		380	A^2s
Power dissipation	P_{tot}	$T_j = T_{jmax}$ $T_s = 80\text{ }^\circ\text{C}$	68	W
Maximum Junction Temperature	T_{jmax}		150	$^\circ\text{C}$
Inverter Switch				
Collector-emitter breakdown voltage	V_{CE}		1200	V
DC collector current	I_C	$T_j = T_{jmax}$ $T_s = 80\text{ }^\circ\text{C}$	21	A
Repetitive peak collector current	I_{CRM}	t_p limited by T_{jmax}	45	A
Turn off safe operating area		$V_{CE} \leq 1200\text{V}$, $T_j \leq T_{op\text{ max}}$,	30	A
Power dissipation	P_{tot}	$T_j = T_{jmax}$ $T_s = 80\text{ }^\circ\text{C}$	71	W
Gate-emitter peak voltage	V_{GE}		± 20	V
Short circuit ratings	t_{SC} V_{CC}	$T_j \leq 150\text{ }^\circ\text{C}$ $V_{GE} = 15\text{ V}$	10 800	μs V
Maximum Junction Temperature	T_{jmax}		175	$^\circ\text{C}$

**Maximum Ratings** $T_j = 25\text{ °C}$, unless otherwise specified

Parameter	Symbol	Condition	Value	Unit
-----------	--------	-----------	-------	------

Inverter Diode

Peak Repetitive Reverse Voltage	V_{RRM}		1200	V
DC forward current	I_F	$T_j = T_{jmax}$ $T_s = 80\text{ °C}$	14	A
Repetitive peak forward current	I_{FRM}	t_p limited by T_{jmax}	30	A
Power dissipation	P_{tot}	$T_j = T_{jmax}$ $T_s = 80\text{ °C}$	52	W
Maximum Junction Temperature	T_{jmax}		175	°C

Brake Switch

Collector-emitter breakdown voltage	V_{CE}		1200	V
DC collector current	I_C	$T_j = T_{jmax}$ $T_s = 80\text{ °C}$	11	A
Repetitive peak collector current	I_{CRM}	t_p limited by T_{jmax}	24	A
Turn off safe operating area		$V_{CE} \leq 1200V, T_j \leq T_{op\ max}$	16	A
Power dissipation	P_{tot}	$T_j = T_{jmax}$ $T_s = 80\text{ °C}$	61	W
Gate-emitter peak voltage	V_{GE}		± 20	V
Short circuit ratings	t_{SC} V_{CC}	$T_j \leq 150\text{ °C}$ $V_{GE} = 15\text{ V}$	10 800	μs V
Maximum Junction Temperature	T_{jmax}		175	°C

Brake Diode

Peak Repetitive Reverse Voltage	V_{RRM}		1200	V
DC forward current	I_F	$T_j = T_{jmax}$ $T_s = 80\text{ °C}$	14	A
Repetitive peak forward current	I_{FRM}	t_p limited by T_{jmax}	20	A
Power dissipation	P_{tot}	$T_j = T_{jmax}$ $T_s = 80\text{ °C}$	46	W
Maximum Junction Temperature	T_{jmax}		175	°C

Thermal Properties

Storage temperature	T_{stg}		-40...+125	°C
Operation temperature under switching condition	T_{op}		-40...+($T_{jmax} - 25$)	°C

Isolation Properties

Isolation voltage	V_{is}	$t = 2\text{ s}$ DC Test Voltage	4000	V
Creepage distance			min 12,7	mm
Clearance		12mm housing	8,06	mm
		17mm housing	min 12,7	mm
Comparative tracking index	CTI		>200	



Characteristic Values

Parameter	Symbol	Conditions					Value			Unit
		V_{GE} [V] V_{GS} [V]	V_r [V] V_{CE} [V] V_{DS} [V]	I_C [A] I_F [A] I_D [A]	T_j [°C]	Min	Typ	Max		
Rectifier Diode										
Forward voltage	V_F				30	25 125	0,8	1,16 1,13	1,6	V
Threshold voltage (for power loss calc. only)	V_{to}				30	25 125		0,90 0,78		V
Slope resistance (for power loss calc. only)	r_t				30	25 125		8,00 11,00	20	mΩ
Reverse current	I_r			1600		25 150			2	mA
Thermal resistance junction to sink	$R_{th(j-s)}$	Phase-Change Material $\lambda = 3,4$ W/mK						1,03		K/W
Inverter Switch										
Gate emitter threshold voltage	$V_{GE(th)}$	$V_{CE} = V_{GE}$			0,0005	25	5	5,8	6,5	V
Collector-emitter saturation voltage	V_{CEsat}		15		15	25 125	0,8	1,84 2,25	2,25	V
Collector-emitter cut-off current incl. Diode	I_{CES}		0	1200		25			0,005	mA
Gate-emitter leakage current	I_{GES}		20	0		25			200	nA
Integrated Gate resistor	R_{gint}							none		Ω
Turn-on delay time	$t_{d(on)}$	$R_{gon} = 32 \Omega$ $R_{goff} = 32 \Omega$	± 15	600	15	25		85		ns
Rise time	t_r					125		85		
Turn-off delay time	$t_{d(off)}$					25		17		
Fall time	t_f					125		22		
Turn-on energy loss	E_{on}					25		201		
Turn-off energy loss	E_{off}	125		264						
Input capacitance	C_{ies}	$f = 1$ MHz	0	25	25			900		pF
Output capacitance	C_{oss}							80		
Reverse transfer capacitance	C_{rss}							55		
Gate charge	Q_G		± 15			25		120		nC
Thermal resistance junction to sink	$R_{th(j-s)}$	Phase-Change Material $\lambda = 3,4$ W/mK						1,35		K/W
Inverter Diode										
Diode forward voltage	V_F				15	25 125	1,35	1,61 1,50	2,05	V
Peak reverse recovery current	I_{RRM}	$R_{gon} = 32 \Omega$	0	600	15	25		25		A
Reverse recovery time	t_{rr}					125		26		
Reverse recovered charge	Q_{rr}					25		153		
Peak rate of fall of recovery current	$(di_{rr}/dt)_{max}$					125		313		
Reverse recovered energy	E_{rec}					25		1,35 2,98		
Thermal resistance junction to sink	$R_{th(j-s)}$	Phase-Change Material $\lambda = 3,4$ W/mK						0,518 1,259		mWs
								1,83		K/W



Characteristic Values

Parameter	Symbol	Conditions					Value			Unit	
		V_{GE} [V] V_{GS} [V]	V_r [V] V_{CE} [V] V_{DS} [V]	I_C [A] I_F [A] I_D [A]	T_j [°C]	Min	Typ	Max			
Brake Switch											
Gate emitter threshold voltage	$V_{GE(th)}$	$V_{CE} = V_{GE}$				0,0005	25	5	5,8	6,5	V
Collector-emitter saturation voltage	V_{CESat}		15			15	25 125	1,3	1,82 2,23	2,15	V
Collector-emitter cut-off incl diode	I_{CES}		0				25			0,005	mA
Gate-emitter leakage current	I_{GES}		20	0			25			200	nA
Integrated Gate resistor	R_{gint}								none		Ω
Turn-on delay time	$t_{d(on)}$						25 125		53 55		ns
Rise time	t_r						25 125		18 23		
Turn-off delay time	$t_{d(off)}$	$R_{goff} = 32 \Omega$ $R_{gonn} = 32 \Omega$	±15	600	15		25 125		169 231		
Fall time	t_f						25 125		82 119		
Turn-on energy loss	E_{on}						25 125		0,47 0,75		mWs
Turn-off energy loss	E_{off}						25 125		0,44 0,68		
Input capacitance	C_{ies}								490		pF
Output capacitance	C_{oss}	$f = 1 \text{ MHz}$	0	25		25			50		
Reverse transfer capacitance	C_{rss}								30		
Gate charge	Q_G						25		50		nC
Thermal resistance junction to sink	$R_{th(j-s)}$	Phase-Change Material $\lambda = 3,4 \text{ W/mK}$							1,57		K/W
Brake Diode											
Diode forward voltage	V_F					10	25 125	1,3	2,31 1,89	2,2	V
Reverse leakage current	I_r					1200	25			5	μA
Peak reverse recovery current	I_{RRM}						25 125		8 10		A
Reverse recovery time	t_{rr}	$R_{goff} = 32 \Omega$ $R_{gonn} = 32 \Omega$	15	600	15		25 125		273 415		ns
Reverse recovered charge	Q_{rr}						25 125		0,92 0,92		μC
Peak rate of fall of recovery current	$(di_{rr}/dt)_{max}$						25 125		68 65		A/μs
Reverse recovery energy	E_{rec}						25 125		0,38 0,70		mWs
Thermal resistance junction to sink	$R_{th(j-s)}$	Phase-Change Material $\lambda = 3,4 \text{ W/mK}$							2,07		K/W
Thermistor											
Rated resistance	R						25		22000		Ω
Deviation of R_{100}	$\Delta_{R/R}$						25	-5		5	%
Power dissipation	P						25		200		mW
Power dissipation constant							25		2		mW/K
B-value	$B_{(25/50)}$	Tol. ±3%					25		3950		K
B-value	$B_{(25/100)}$						25		3996		K
Vincotech NTC Reference										B	



Inverter Characteristics

Figure 1 Inverter IGBT

Typical output characteristics

$$I_C = f(V_{CE})$$

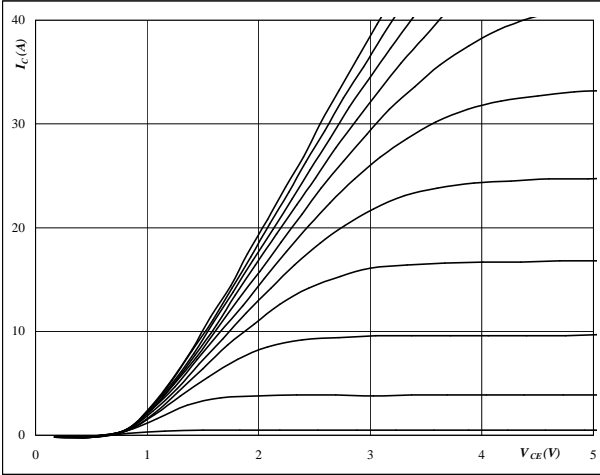

At

$t_p = 250 \mu s$
 $T_j = 25 \text{ } ^\circ C$
 V_{GE} from 7 V to 17 V in steps of 1 V

Figure 2 Inverter IGBT

Typical output characteristics

$$I_C = f(V_{CE})$$

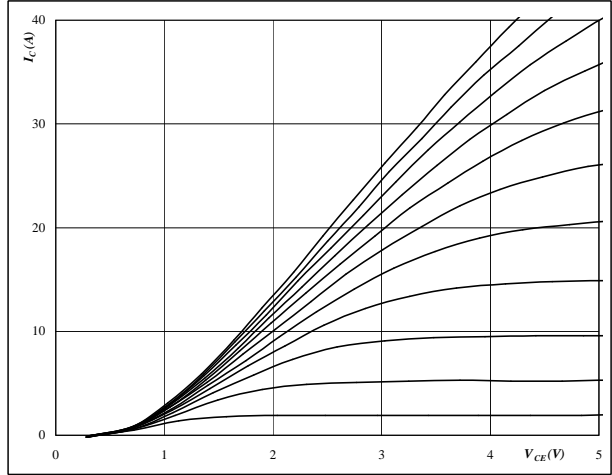

At

$t_p = 250 \mu s$
 $T_j = 150 \text{ } ^\circ C$
 V_{GE} from 7 V to 17 V in steps of 1 V

Figure 3 Inverter IGBT

Typical transfer characteristics

$$I_C = f(V_{GE})$$

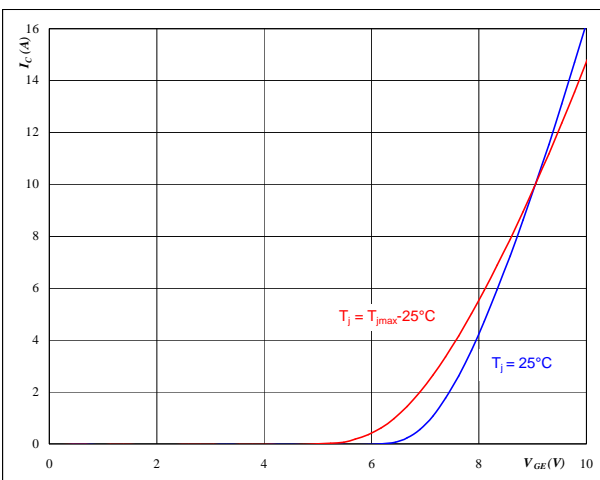

At

$t_p = 250 \mu s$
 $V_{CE} = 10 V$

Figure 4 Inverter FWD

Typical diode forward current as a function of forward voltage

$$I_F = f(V_F)$$

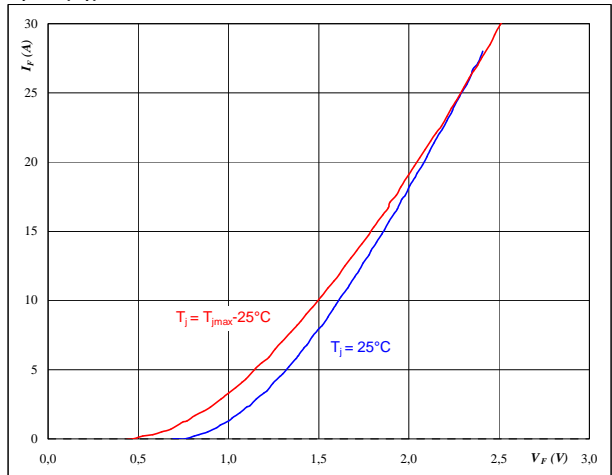

At

$t_p = 250 \mu s$



Inverter Characteristics

Figure 5 Inverter IGBT

Typical switching energy losses as a function of collector current

$E = f(I_C)$

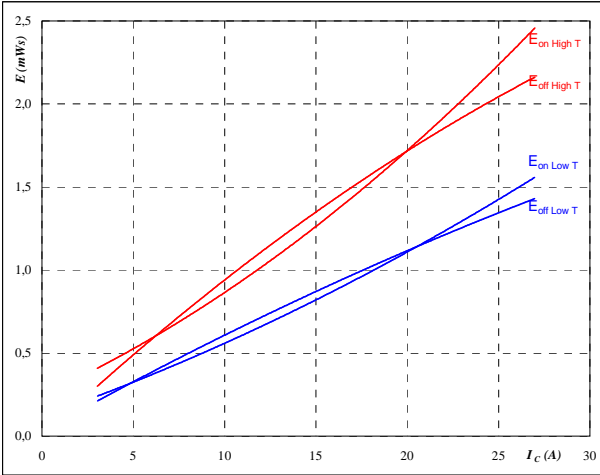

With an inductive load at

- $T_j = 25/150$ °C
- $V_{CE} = 600$ V
- $V_{GE} = \pm 15$ V
- $R_{gon} = 32$ Ω
- $R_{goff} = 32$ Ω

Figure 6 Inverter IGBT

Typical switching energy losses as a function of gate resistor

$E = f(R_G)$

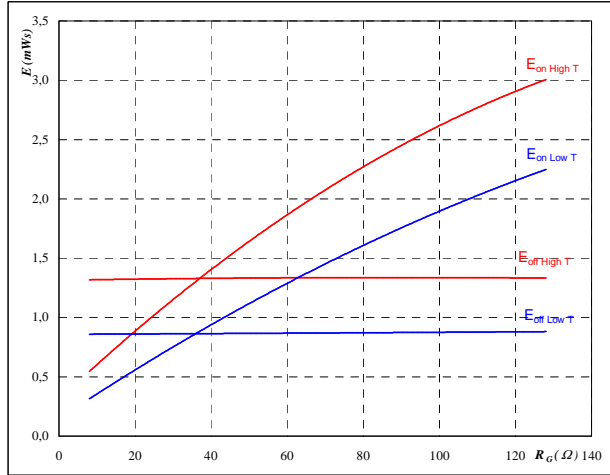

With an inductive load at

- $T_j = 25/150$ °C
- $V_{CE} = 600$ V
- $V_{GE} = \pm 15$ V
- $I_C = 15$ A

Figure 7 Inverter FWD

Typical reverse recovery energy loss as a function of collector current

$E_{rec} = f(I_C)$

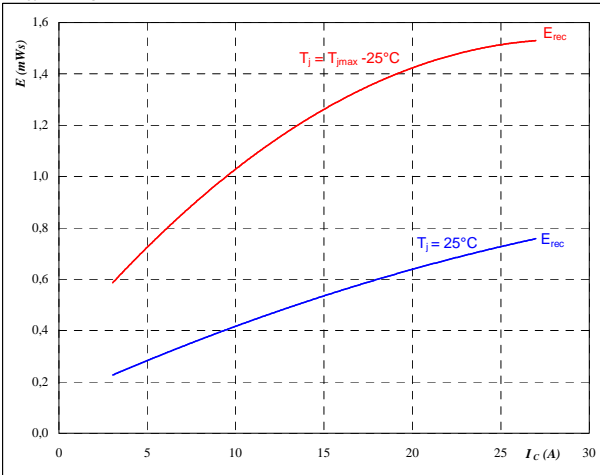

With an inductive load at

- $T_j = 25/150$ °C
- $V_{CE} = 600$ V
- $V_{GE} = \pm 15$ V
- $R_{gon} = 32$ Ω

Figure 8 Inverter FWD

Typical reverse recovery energy loss as a function of gate resistor

$E_{rec} = f(R_G)$

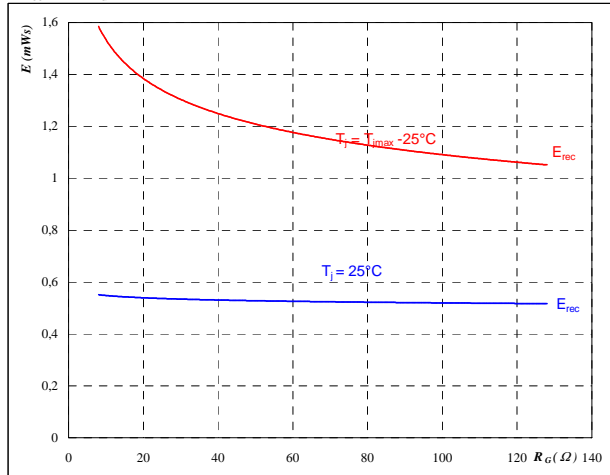

With an inductive load at

- $T_j = 25/150$ °C
- $V_{CE} = 600$ V
- $V_{GE} = \pm 15$ V
- $I_C = 15$ A



Inverter Characteristics

Figure 9 Inverter IGBT

Typical switching times as a function of collector current

$$t = f(I_C)$$

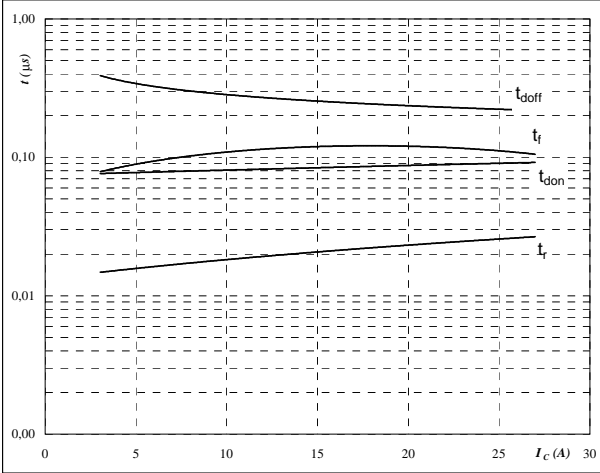

With an inductive load at

$T_j =$	150	°C
$V_{CE} =$	600	V
$V_{GE} =$	±15	V
$R_{gon} =$	32	Ω
$R_{goff} =$	32	Ω

Figure 10 Inverter IGBT

Typical switching times as a function of gate resistor

$$t = f(R_G)$$

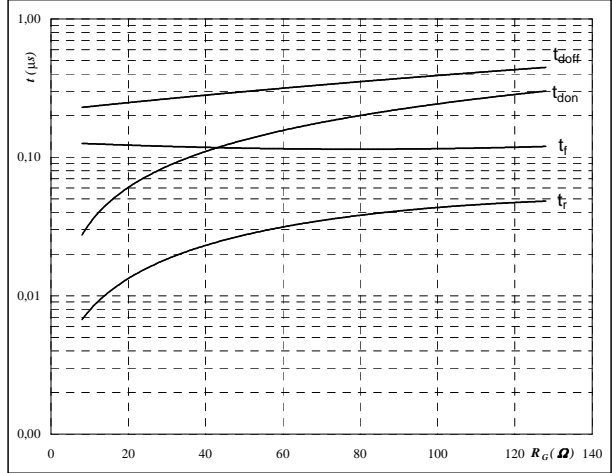

With an inductive load at

$T_j =$	150	°C
$V_{CE} =$	600	V
$V_{GE} =$	±15	V
$I_C =$	15	A

Figure 11 Inverter FWD

Typical reverse recovery time as a function of collector current

$$t_{rr} = f(I_C)$$

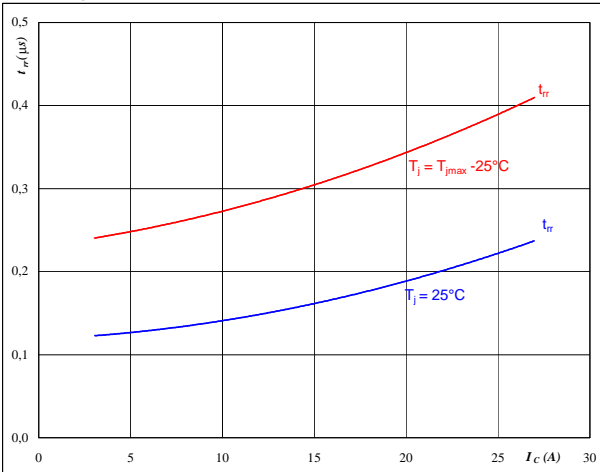

At

$T_j =$	25/150	°C
$V_{CE} =$	600	V
$V_{GE} =$	±15	V
$R_{gon} =$	32	Ω

Figure 12 Inverter FWD

Typical reverse recovery time as a function of IGBT turn on gate resistor

$$t_{rr} = f(R_{gon})$$

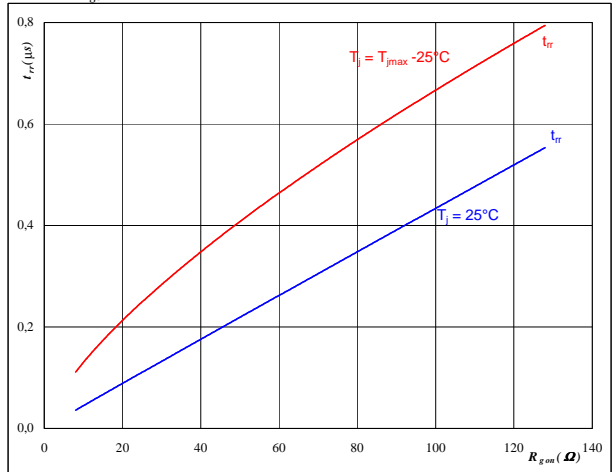

At

$T_j =$	25/150	°C
$V_R =$	600	V
$I_F =$	15	A
$V_{GE} =$	±15	V



Inverter Characteristics

Figure 13 Inverter FWD

Typical reverse recovery charge as a function of collector current

$$Q_{rr} = f(I_C)$$

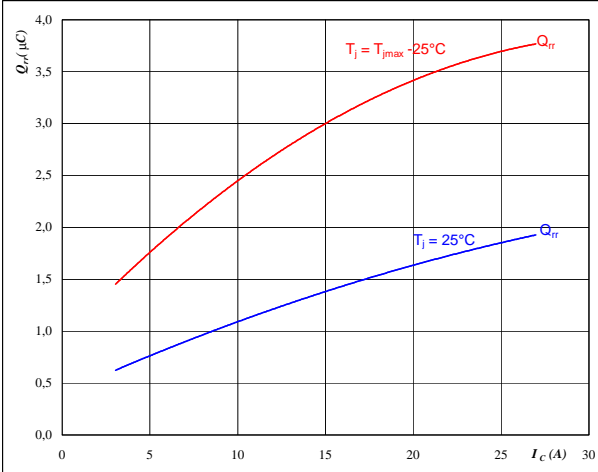

At
 $T_j = 25/150$ °C
 $V_{CE} = 600$ V
 $V_{GE} = \pm 15$ V
 $R_{gon} = 32$ Ω

Figure 14 Inverter FWD

Typical reverse recovery charge as a function of IGBT turn on gate resistor

$$Q_{rr} = f(R_{gon})$$

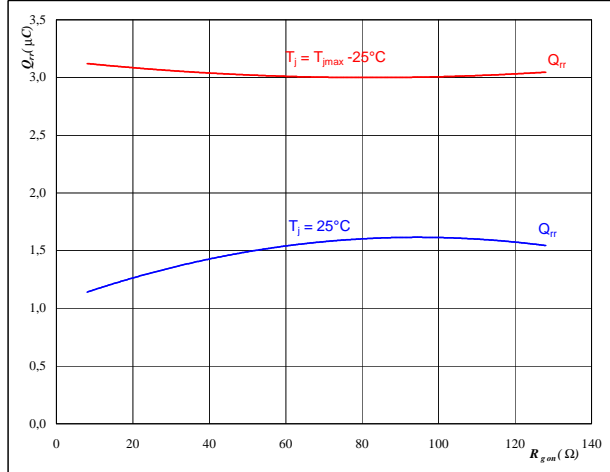

At
 $T_j = 25/150$ °C
 $V_R = 600$ V
 $I_F = 15$ A
 $V_{GE} = \pm 15$ V

Figure 15 Inverter FWD

Typical reverse recovery current as a function of collector current

$$I_{RRM} = f(I_C)$$

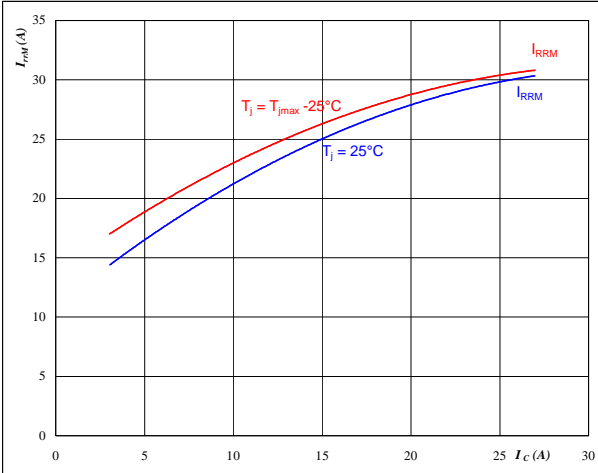

At
 $T_j = 25/150$ °C
 $V_{CE} = 600$ V
 $V_{GE} = \pm 15$ V
 $R_{gon} = 32$ Ω

Figure 16 Inverter FWD

Typical reverse recovery current as a function of IGBT turn on gate resistor

$$I_{RRM} = f(R_{gon})$$

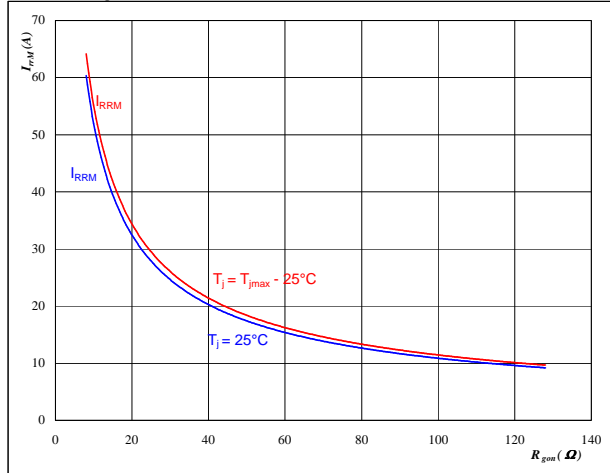

At
 $T_j = 25/150$ °C
 $V_R = 600$ V
 $I_F = 15$ A
 $V_{GE} = \pm 15$ V



Inverter Characteristics

Figure 17 Inverter FWD

Typical rate of fall of forward and reverse recovery current as a function of collector current

$$dI_0/dt, dI_{rec}/dt = f(I_C)$$

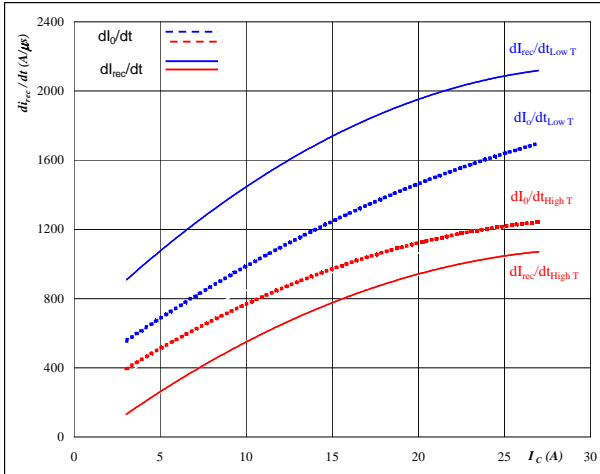

At
 $T_j = 25/150$ °C
 $V_{CE} = 600$ V
 $V_{GE} = \pm 15$ V
 $R_{gon} = 32$ Ω

Figure 18 Inverter FWD

Typical rate of fall of forward and reverse recovery current as a function of IGBT turn on gate resistor

$$dI_0/dt, dI_{rec}/dt = f(R_{gon})$$

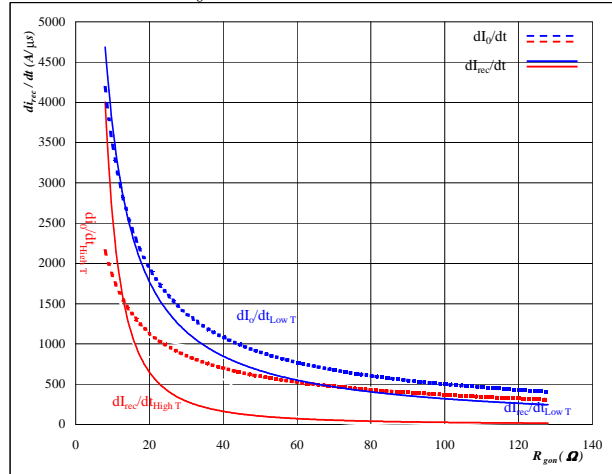

At
 $T_j = 25/150$ °C
 $V_R = 600$ V
 $I_F = 15$ A
 $V_{GE} = \pm 15$ V

Figure 19 Inverter IGBT

IGBT transient thermal impedance as a function of pulse width

$$Z_{th(j-s)} = f(t_p)$$

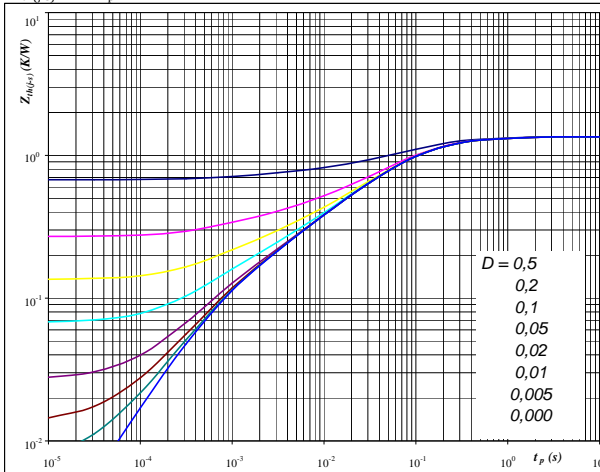

At
 $D = t_p / T$
 $R_{th(j-s)} = 1,35$ K/W

IGBT thermal model values

R (K/W)	Tau (s)
0,16	5,9E-01
0,63	9,4E-02
0,28	2,9E-02
0,16	6,7E-03
0,09	9,4E-04
0,02	3,8E-04

Figure 20 Inverter FWD

FWD transient thermal impedance as a function of pulse width

$$Z_{th(j-s)} = f(t_p)$$

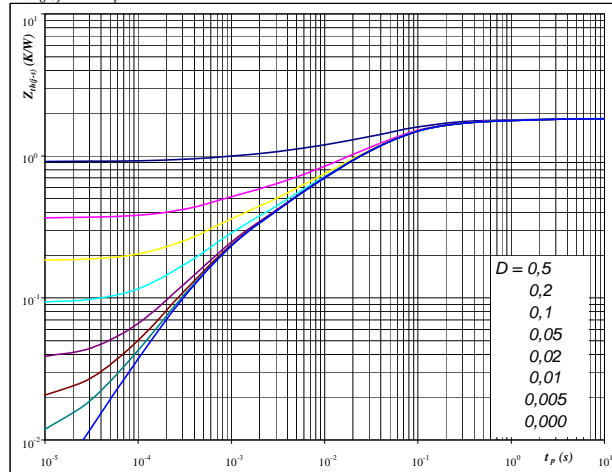

At
 $D = t_p / T$
 $R_{th(j-s)} = 1,83$ K/W

FWD thermal model values

R (K/W)	Tau (s)
0,06	2,8E+00
0,14	3,9E-01
0,71	6,8E-02
0,50	2,0E-02
0,25	4,0E-03
0,18	5,9E-04



Inverter Characteristics

Figure 21 Inverter IGBT

Power dissipation as a function of heatsink temperature

$P_{tot} = f(T_s)$

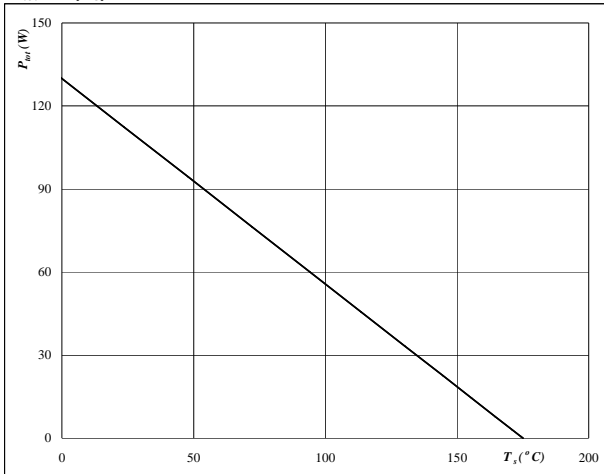

At
 $T_j = 175$ °C

Figure 22 Inverter IGBT

Collector current as a function of heatsink temperature

$I_C = f(T_s)$

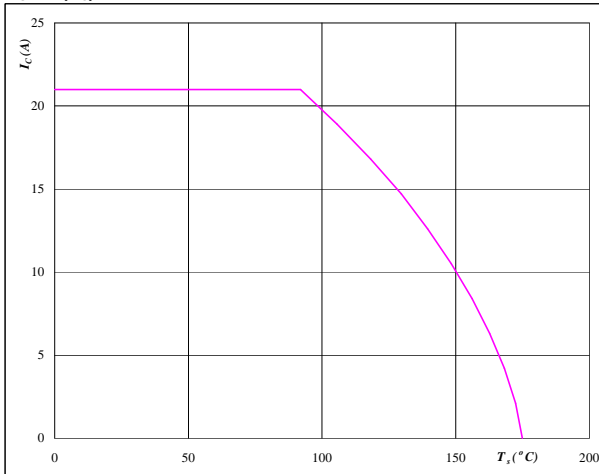

At
 $T_j = 175$ °C
 $V_{GE} = 15$ V

Figure 23 Inverter FWD

Power dissipation as a function of heatsink temperature

$P_{tot} = f(T_s)$

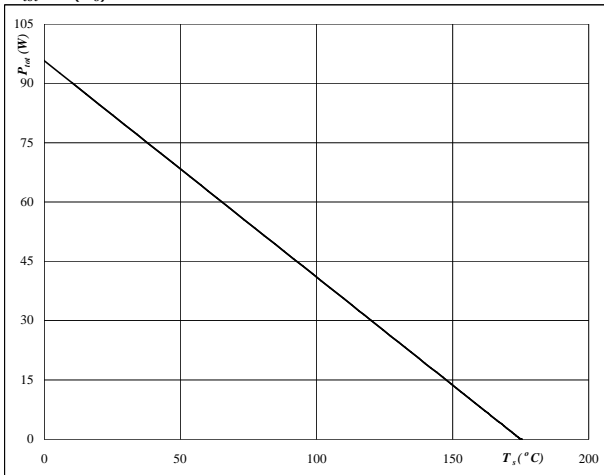

At
 $T_j = 175$ °C

Figure 24 Inverter FWD

Forward current as a function of heatsink temperature

$I_F = f(T_s)$

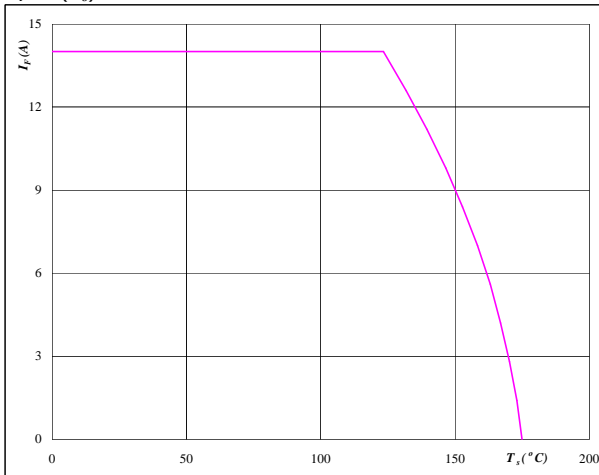

At
 $T_j = 175$ °C



Inverter Characteristics

Figure 25 Inverter IGBT

Safe operating area as a function of collector-emitter voltage

$I_C = f(V_{CE})$

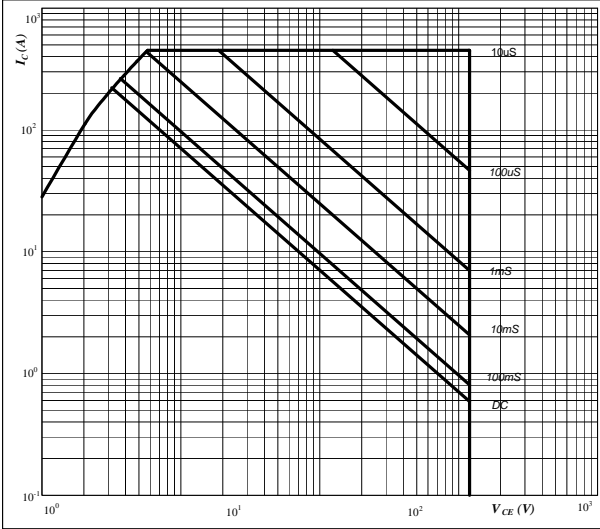

At
 $D =$ single pulse
 $T_s =$ 80 °C
 $V_{GE} =$ ±15 V
 $T_j = T_{jmax}$

Figure 26 Inverter IGBT

Gate voltage vs Gate charge

$V_{GE} = f(Q_G)$

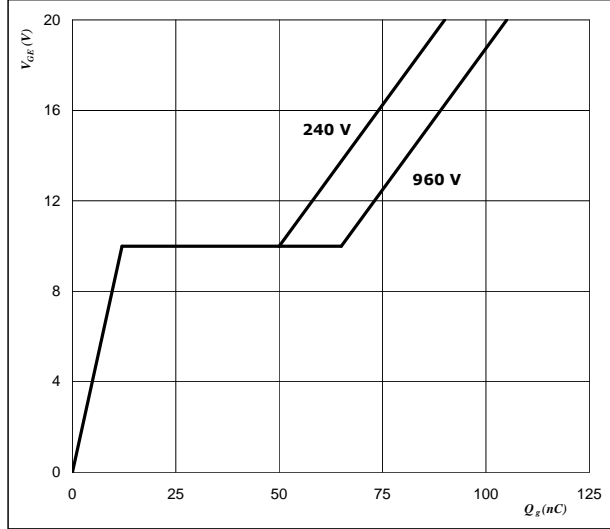

At
 $I_C =$ 15 A

Figure 27 Inverter IGBT

Short circuit withstand time as a function of gate-emitter voltage

$t_{sc} = f(V_{GE})$

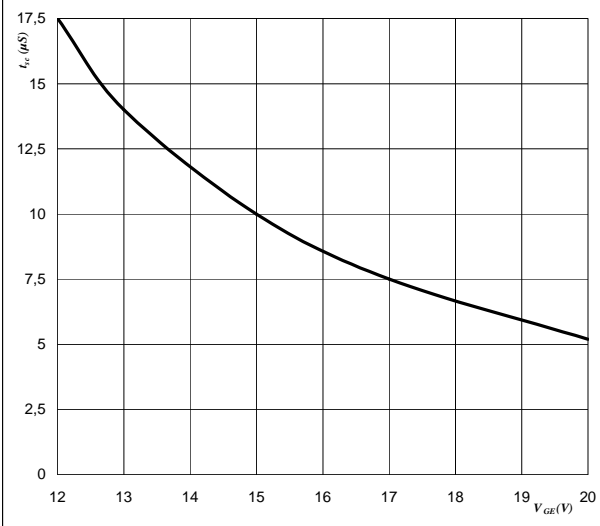

At
 $V_{CE} =$ 1200 V
 $T_j \leq$ 175 °C

Figure 28 Inverter IGBT

Typical short circuit collector current as a function of gate-emitter voltage

$I_{C(sc)} = f(V_{GE})$

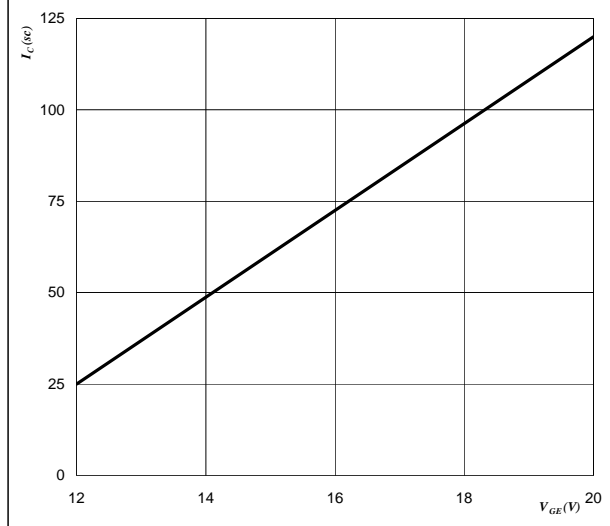

At
 $V_{CE} \leq$ 1200 V
 $T_j =$ 175 °C



Inverter Characteristics

Figure 29 Inverter IGBT

Reverse bias safe operating area

$$I_C = f(V_{CE})$$

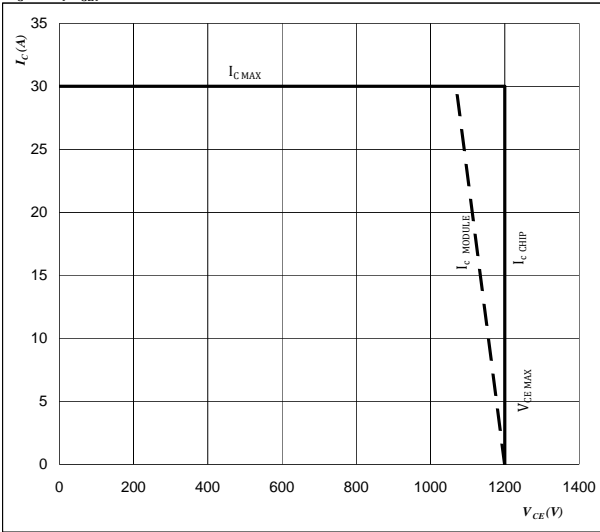

At

$$T_j = T_{j,max} - 25 \text{ } ^\circ\text{C}$$



Brake Characteristics

Figure 1 Brake IGBT

Typical output characteristics

$$I_C = f(V_{CE})$$

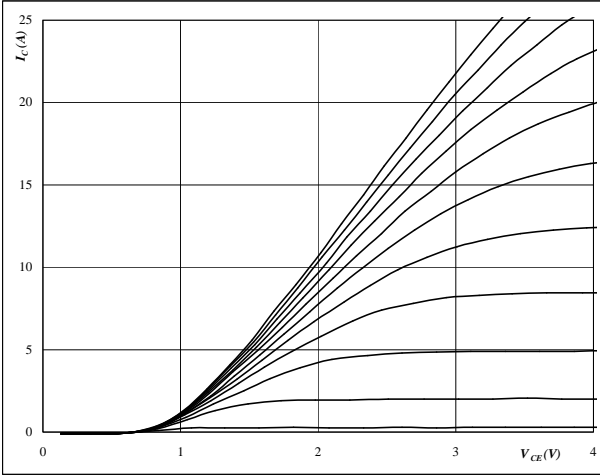

At

$t_p = 250 \mu s$
 $T_j = 25 \text{ } ^\circ C$
 V_{GE} from 7 V to 17 V in steps of 1 V

Figure 2 Brake IGBT

Typical output characteristics

$$I_C = f(V_{CE})$$

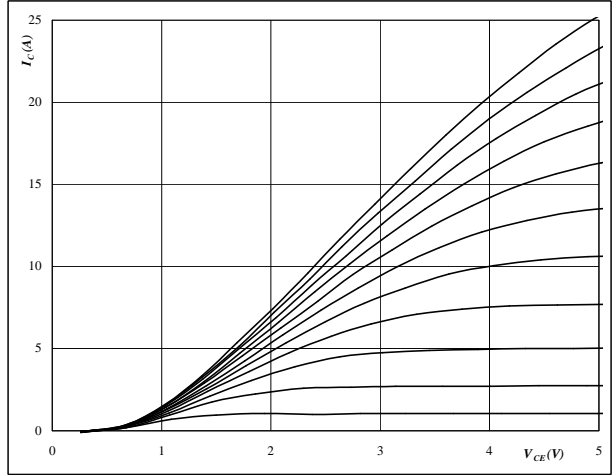

At

$t_p = 250 \mu s$
 $T_j = 150 \text{ } ^\circ C$
 V_{GE} from 7 V to 17 V in steps of 1 V

Figure 3 Brake IGBT

Typical transfer characteristics

$$I_C = f(V_{GE})$$

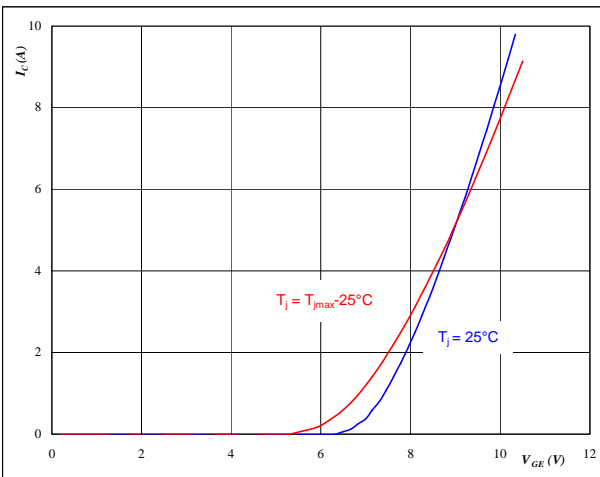

At

$t_p = 250 \mu s$
 $V_{CE} = 10 \text{ V}$

Figure 4 Brake FWD

Typical diode forward current as a function of forward voltage

$$I_F = f(V_F)$$

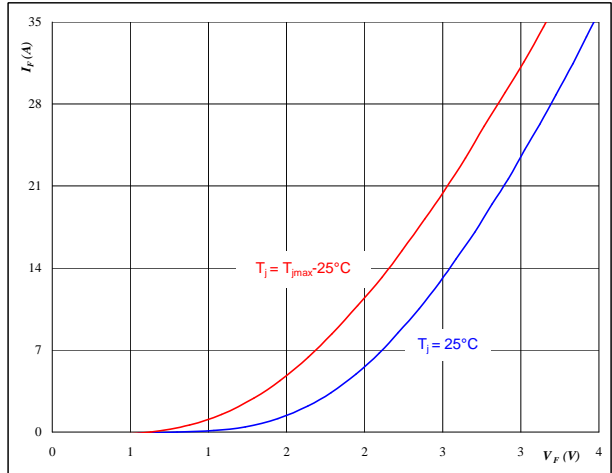

At

$t_p = 250 \mu s$



Brake Characteristics

Figure 5 Brake IGBT

Typical switching energy losses as a function of collector current

$E = f(I_C)$

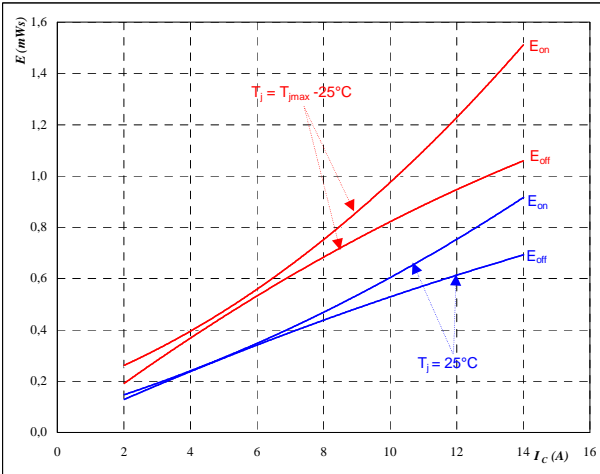

With an inductive load at

- $T_j = 25/150$ °C
- $V_{CE} = 600$ V
- $V_{GE} = \pm 15$ V
- $R_{gon} = 32$ Ω
- $R_{goff} = 32$ Ω

Figure 6 Brake IGBT

Typical switching energy losses as a function of gate resistor

$E = f(R_G)$

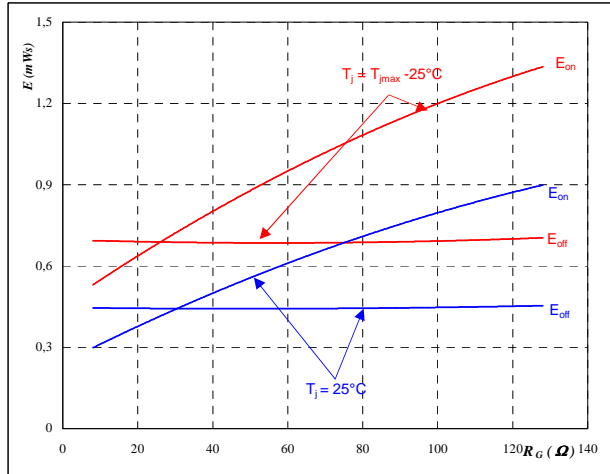

With an inductive load at

- $T_j = 25/150$ °C
- $V_{CE} = 600$ V
- $V_{GE} = \pm 15$ V
- $I_C = 8$ A

Figure 7 Brake FWD

Typical reverse recovery energy loss as a function of collector current

$E_{rec} = f(I_C)$

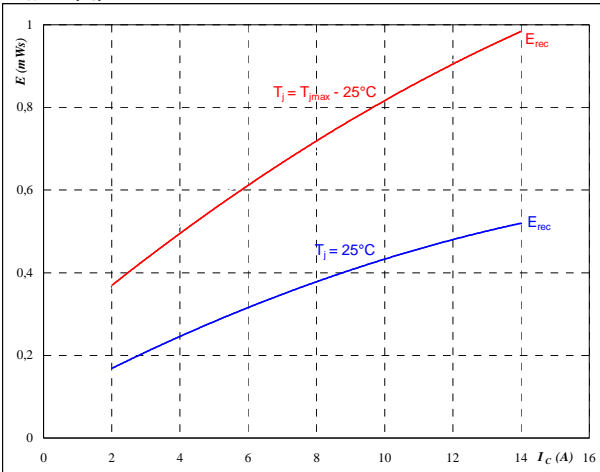

With an inductive load at

- $T_j = 25/150$ °C
- $V_{CE} = 600$ V
- $V_{GE} = \pm 15$ V
- $R_{gon} = 32$ Ω

Figure 8 Brake FWD

Typical reverse recovery energy loss as a function of gate resistor

$E_{rec} = f(R_G)$

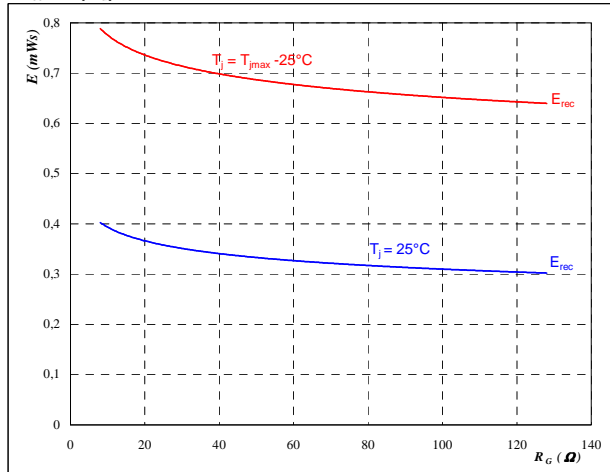

With an inductive load at

- $T_j = 25/150$ °C
- $V_{CE} = 600$ V
- $V_{GE} = \pm 15$ V
- $I_C = 8$ A



Brake Characteristics

Figure 9 Brake IGBT

Typical switching times as a function of collector current

$$t = f(I_C)$$

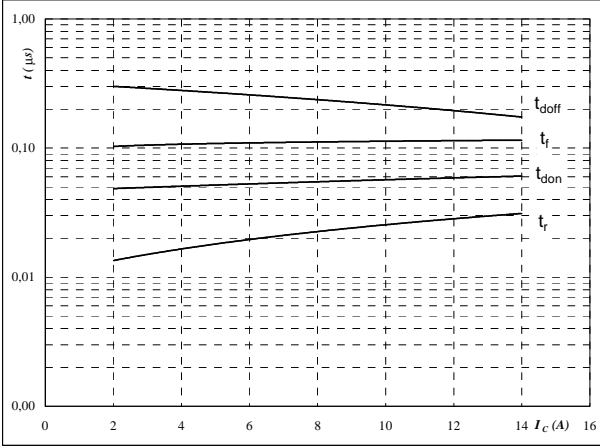

With an inductive load at

$T_j = 25/150$ °C
 $V_{CE} = 600$ V
 $V_{GE} = \pm 15$ V
 $R_{gon} = 32$ Ω
 $R_{goff} = 32$ Ω

Figure 10 Brake IGBT

Typical switching times as a function of gate resistor

$$t = f(R_G)$$

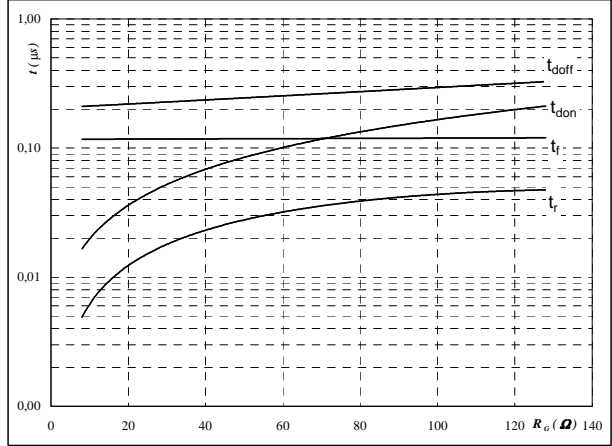

With an inductive load at

$T_j = 25/150$ °C
 $V_{CE} = 600$ V
 $V_{GE} = \pm 15$ V
 $I_C = 8$ A

Figure 11 Brake IGBT

IGBT transient thermal impedance as a function of pulse width

$$Z_{th(i-s)} = f(t_p)$$

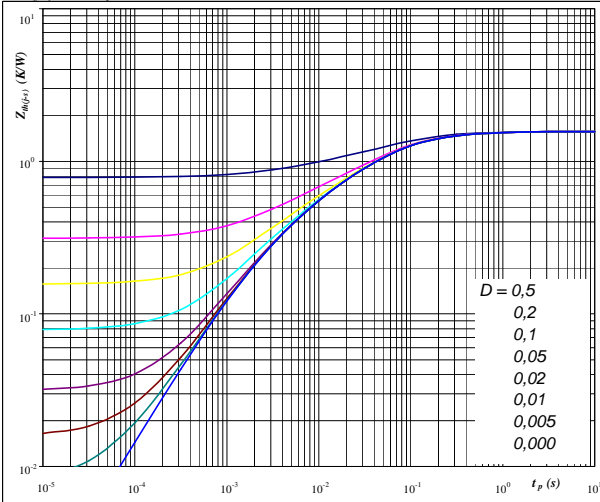

At $D = t_p / T$

$R_{th(i-s)} = 1,57$ K/W

Figure 12 Brake FWD

FWD transient thermal impedance as a function of pulse width

$$Z_{th(i-s)} = f(t_p)$$

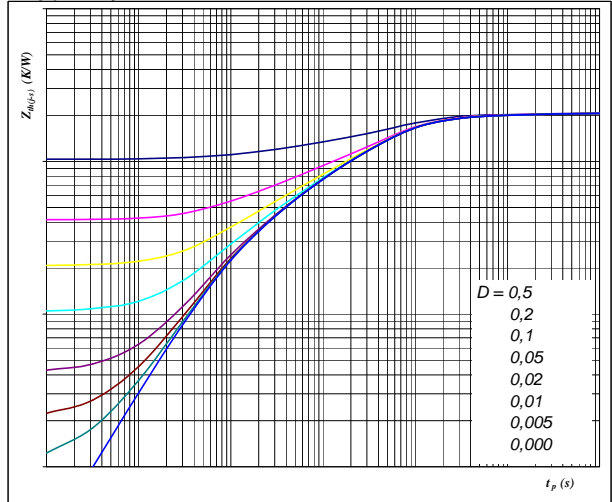

At $D = t_p / T$

$R_{th(i-s)} = 2,07$ K/W



Brake Characteristics

Figure 13 Brake IGBT

Power dissipation as a function of heatsink temperature

$P_{tot} = f(T_s)$

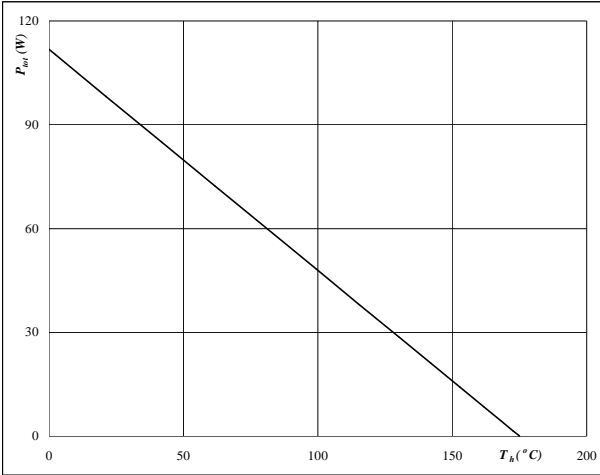

At
 $T_j = 175 \text{ } ^\circ\text{C}$

Figure 14 Brake IGBT

Collector current as a function of heatsink temperature

$I_C = f(T_s)$

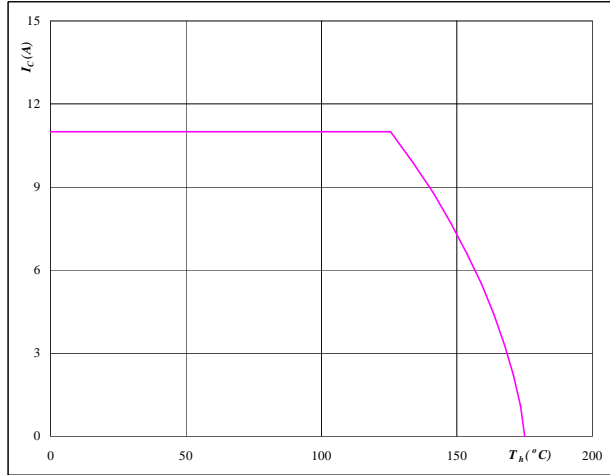

At
 $T_j = 175 \text{ } ^\circ\text{C}$
 $V_{GE} = 15 \text{ V}$

Figure 15 Brake FWD

Power dissipation as a function of heatsink temperature

$P_{tot} = f(T_s)$

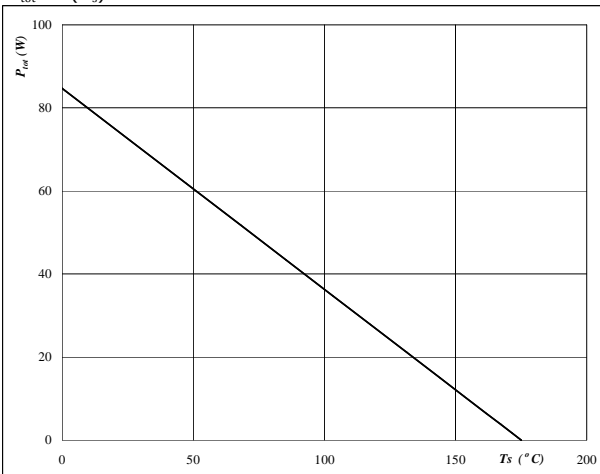

At
 $T_j = 175 \text{ } ^\circ\text{C}$

Figure 16 Brake FWD

Forward current as a function of heatsink temperature

$I_F = f(T_s)$

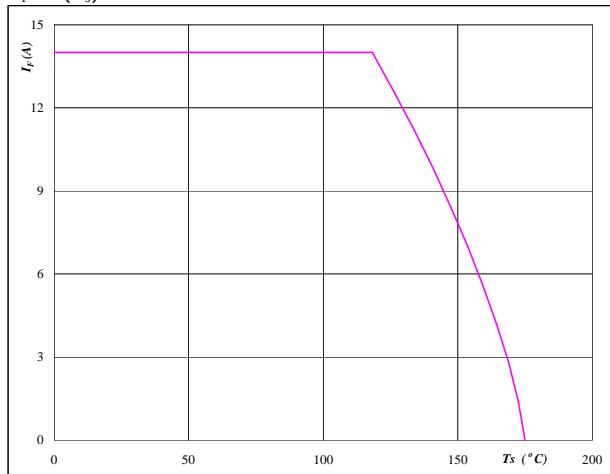

At
 $T_j = 175 \text{ } ^\circ\text{C}$



Rectifier Diode

Figure 1 Rectifier Diode

Typical diode forward current as a function of forward voltage

$$I_F = f(V_F)$$

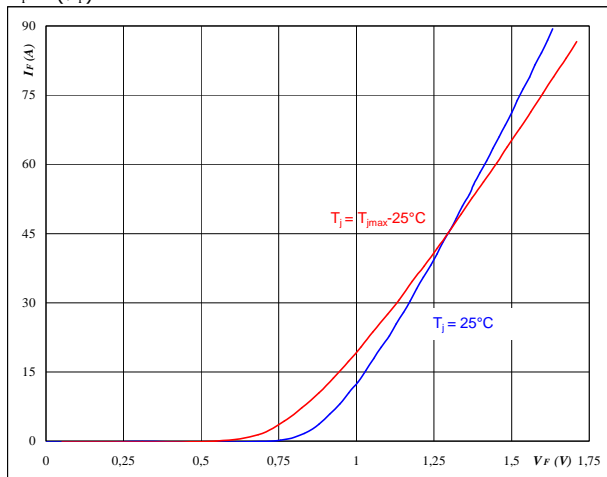

At
 $t_p = 250 \mu s$

Figure 2 Rectifier Diode

Diode transient thermal impedance as a function of pulse width

$$Z_{th(j-s)} = f(t_p)$$

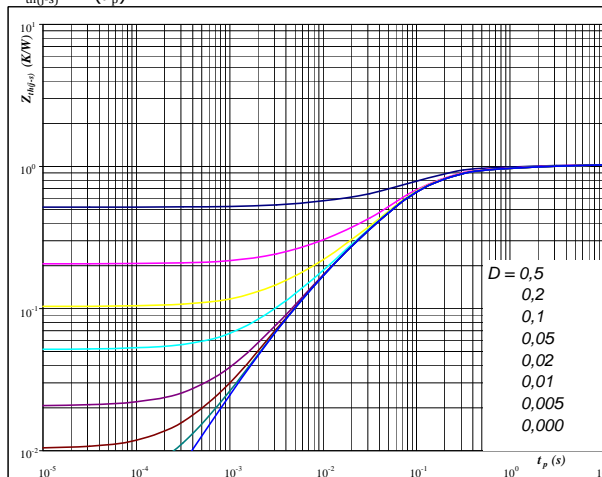

At
 $D = t_p / T$
 $R_{th(j-s)} = 1,03 \text{ K/W}$

Figure 3 Rectifier Diode

Power dissipation as a function of heatsink temperature

$$P_{tot} = f(T_s)$$

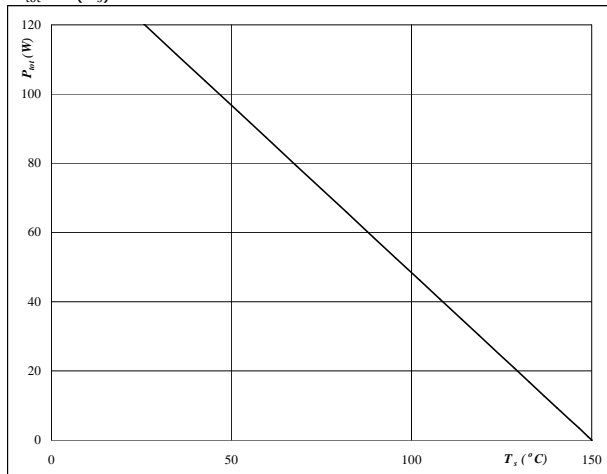

At
 $T_j = 150 \text{ °C}$

Figure 4 Rectifier Diode

Forward current as a function of heatsink temperature

$$I_F = f(T_s)$$

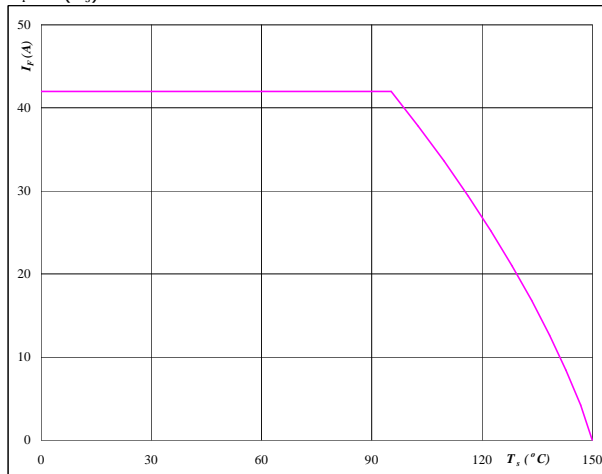

At
 $T_j = 150 \text{ °C}$



Thermistor

Figure 1 Thermistor

**Typical NTC characteristic
as a function of temperature**

$$R_T = f(T)$$

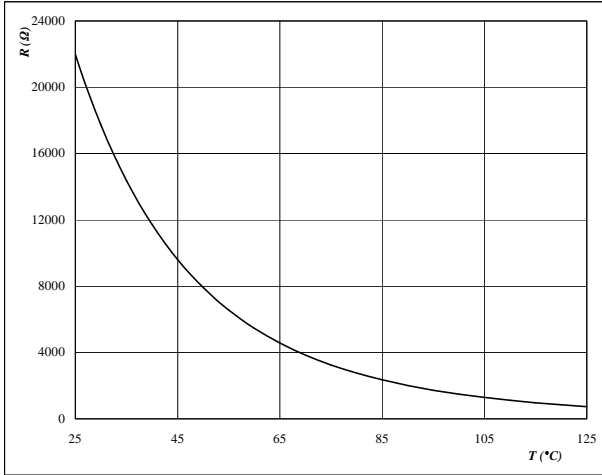



Switching Definitions Inverter

General conditions

T_j	=	150 °C
R_{gon}	=	32 Ω
R_{goff}	=	32 Ω

Figure 1 Inverter IGBT

Turn-off Switching Waveforms & definition of t_{doff} t_{Eoff}
 (t_{Eoff} = integrating time for E_{off})

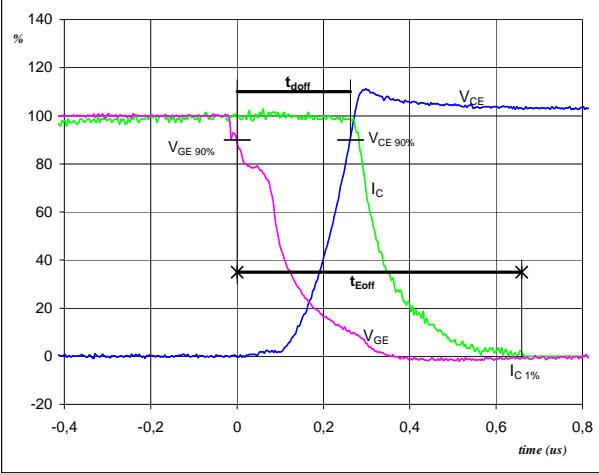

V_{GE} (0%) =	-15	V
V_{GE} (100%) =	15	V
V_C (100%) =	600	V
I_C (100%) =	15	A
t_{doff} =	0,26	μ s
t_{Eoff} =	0,66	μ s

Figure 2 Inverter IGBT

Turn-on Switching Waveforms & definition of t_{don} t_{Eon}
 (t_{Eon} = integrating time for E_{on})

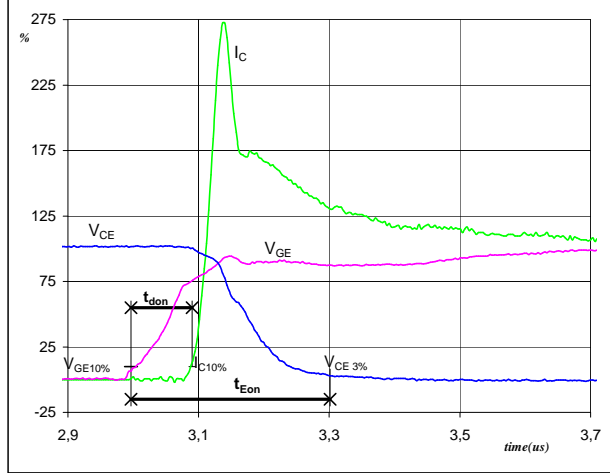

V_{GE} (0%) =	-15	V
V_{GE} (100%) =	15	V
V_C (100%) =	600	V
I_C (100%) =	15	A
t_{don} =	0,09	μ s
t_{Eon} =	0,30	μ s

Figure 3 Inverter IGBT

Turn-off Switching Waveforms & definition of t_f

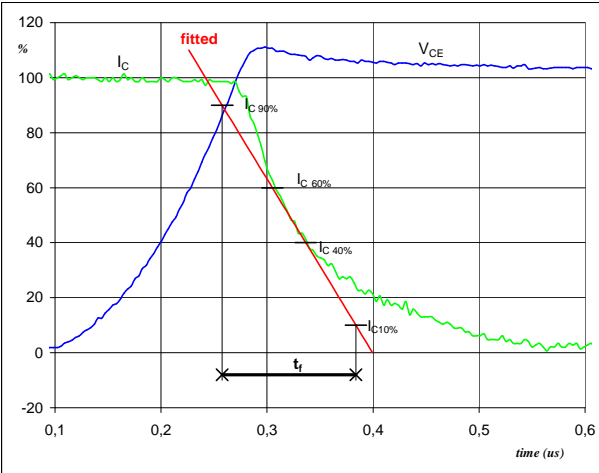

V_C (100%) =	600	V
I_C (100%) =	15	A
t_f =	0,12	μ s

Figure 4 Inverter IGBT

Turn-on Switching Waveforms & definition of t_r

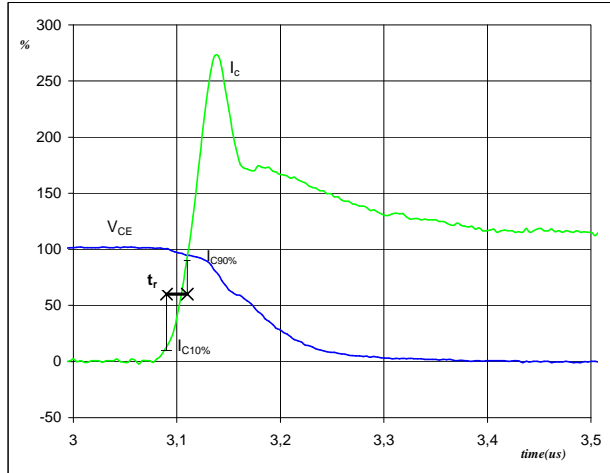

V_C (100%) =	600	V
I_C (100%) =	15	A
t_r =	0,02	μ s



Switching Definitions Inverter

Figure 5 Inverter IGBT
Turn-off Switching Waveforms & definition of t_{Eoff}

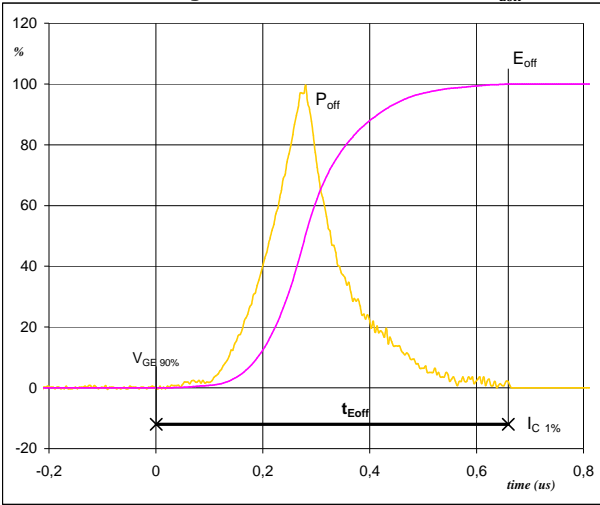

$P_{off} (100\%) = 8,96 \text{ kW}$
 $E_{off} (100\%) = 1,36 \text{ mJ}$
 $t_{Eoff} = 0,66 \text{ μs}$

Figure 6 Inverter IGBT
Turn-on Switching Waveforms & definition of t_{Eon}

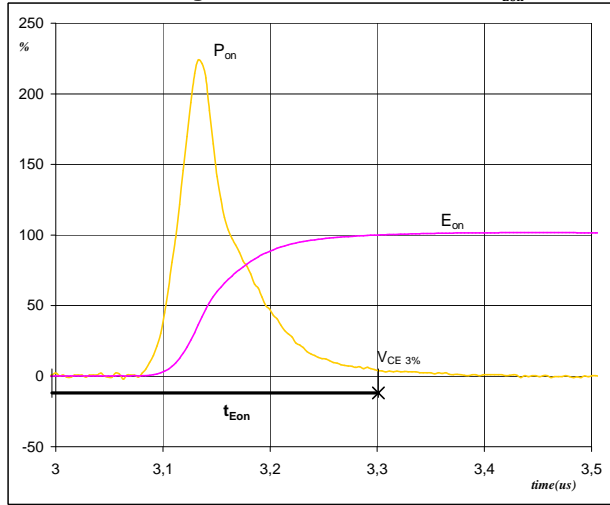

$P_{on} (100\%) = 8,96 \text{ kW}$
 $E_{on} (100\%) = 1,26 \text{ mJ}$
 $t_{Eon} = 0,30 \text{ μs}$

Figure 7 Inverter FWD
Turn-off Switching Waveforms & definition of t_{rr}

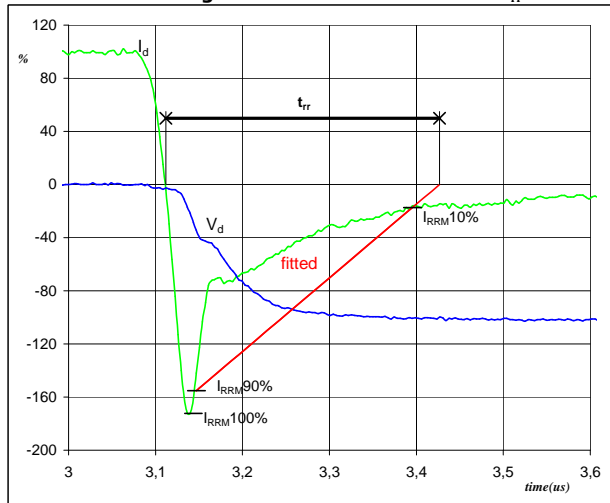

$V_d (100\%) = 600 \text{ V}$
 $I_d (100\%) = 15 \text{ A}$
 $I_{RRM} (100\%) = -26 \text{ A}$
 $t_{rr} = 0,31 \text{ μs}$



Switching Definitions Inverter

Figure 8 Inverter FWD

Turn-on Switching Waveforms & definition of t_{Qrr}
 (t_{Qrr} = integrating time for Q_{rr})

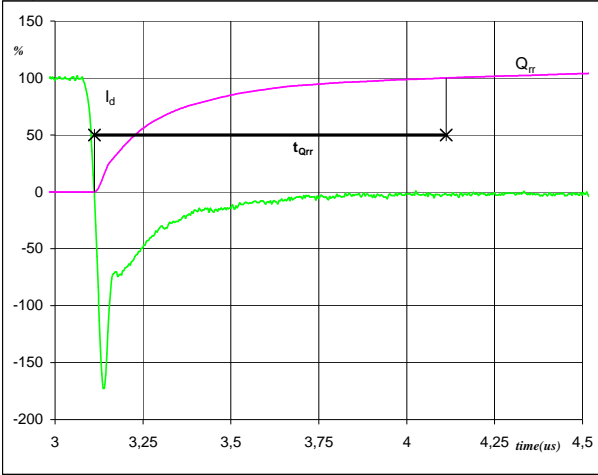

I_d (100%) =	15	A
Q_{rr} (100%) =	2,98	μC
t_{Qrr} =	1,00	μs

Figure 9 Inverter FWD

Turn-on Switching Waveforms & definition of t_{Erec}
 (t_{Erec} = integrating time for E_{rec})

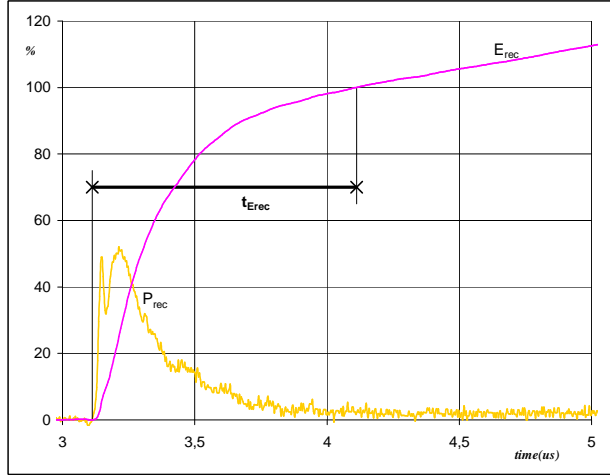

P_{rec} (100%) =	8,96	kW
E_{rec} (100%) =	1,26	mJ
t_{Erec} =	1,00	μs



Ordering Code and Marking - Outline - Pinout

Ordering Code & Marking							
Version				Ordering Code			
Without thermal paste 17mm housing				V23990-P588-A41-PM			
With thermal paste 17mm housing				V23990-P588-A41-/3/-PM			
Without thermal paste 12mm housing				V23990-P588-A418-PM			
With thermal paste 12mm housing				V23990-P588-A418-/3/-PM			
Without thermal paste 17mm housing without brake				V23990-P588-C41-PM			
Without thermal paste 12mm housing without brake				V23990-P588-C418-PM			
With thermal paste 12mm housing without brake				V23990-P588-C418-/3/-PM			
	Text	VIN	Date code	Name&Ver	UL	Lot	Serial
		VIN	WWYY	NNNNNVV	UL	LLLLL	SSSS
	Datamatrix	Name&Ver	Lot number	Serial	Date code		
		NNNNNVV	LLLLL	SSSS	WWYY		

Outline					
Pin table				module	whitout pins
Pin	X	Y	Function	P589-C41	1, 31, 32
1	52,55	0	BrG	P589-C418	1, 31, 32
2	47,7	0	DC-	12mm housing, Press-fit	
3	44,8	0	DC-		
4	37,8	0	DC+		
5	37,8	2,8	DC+		
6	35	0	Inv+		
7	35	2,8	Inv+		
8	28	0	R1		
9	25,2	0	R2		
10	22,4	0	N6		
11	19,6	0	G6		
12	16,8	0	S6		
13	14	0	N4		
14	11,2	0	G4		
15	8,4	0	S4		
16	5,6	0	N2		
17	2,8	0	G2		
18	0	0	S2		
19	0	28,5	U	17mm housing, Press-fit	
20	2,8	28,5	G1		
21	7,5	28,5	S1		
22	14,5	28,5	V		
23	17,3	28,5	G3		
24	22	28,5	S3		
25	29	28,5	W		
26	31,8	28,5	G5		
27	36,5	28,5	S5		
28	43,5	28,5	L1		
29	52,55	25	L2		
30	52,55	16,9	L3		
31	52,55	8,6	BrC		
32	52,55	2,8	BrE		

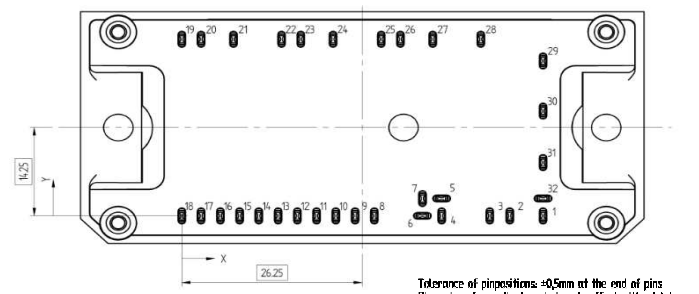



Ordering Code and Marking - Outline - Pinout

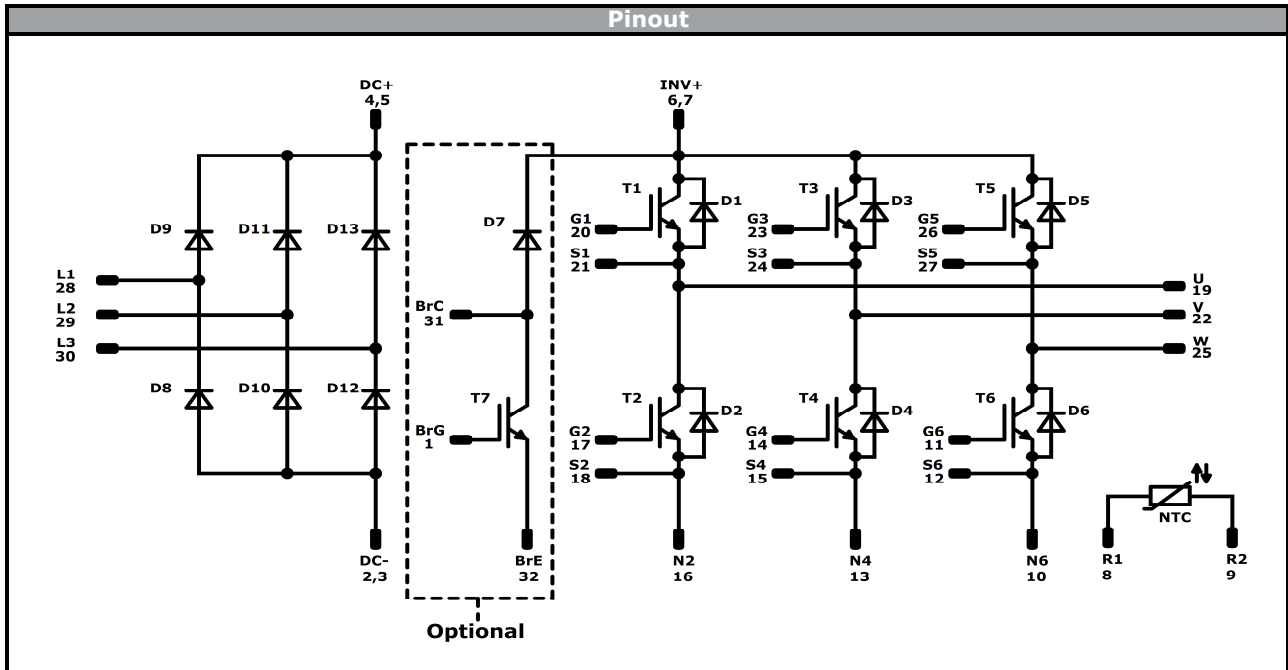

Identification					
ID	Component	Voltage	Current	Function	Comment
T1,T2,T3,T4,T5,T6	IGBT	1200 V	15 A	Inverter Switch	
D1,D2,D3,D4,D5,D6	FWD	1200 V	15 A	Inverter Diode	
T7	IGBT	1200 V	8 A	Brake Switch	
D7	FWD	1200 V	10 A	Brake Diode	
D8,D9,D10,D11,D12,D13	Diode	1600 V	35 A	Rectifier Diode	
NTC	Thermistor			Thermistor	



Packaging instruction			
Standard packaging quantity (SPQ)	135	>SPQ Standard	<SPQ Sample

Handling instruction
Package data for <i>flow</i> 1 packages see vincotech.com website.

Package data
Package data for <i>flow</i> 1 packages see vincotech.com website.

UL recognition and file number
This device is certified according to UL 1557 standard, UL file number E192116. For more information see vincotech.com website. 

Document No.:	Date:	Modification:	Pages
V23990-P588-x4x-D4-14	22 Jun. 2016	New brand, new types added, PCM Rth values	all

DISCLAIMER

The information, specifications, procedures, methods and recommendations herein (together "information") are presented by Vincotech to reader in good faith, are believed to be accurate and reliable, but may well be incomplete and/or not applicable to all conditions or situations that may exist or occur. Vincotech reserves the right to make any changes without further notice to any products to improve reliability, function or design. No representation, guarantee or warranty is made to reader as to the accuracy, reliability or completeness of said information or that the application or use of any of the same will avoid hazards, accidents, losses, damages or injury of any kind to persons or property or that the same will not infringe third parties rights or give desired results. It is reader's sole responsibility to test and determine the suitability of the information and the product for reader's intended use.

LIFE SUPPORT POLICY

Vincotech products are not authorised for use as critical components in life support devices or systems without the express written approval of Vincotech.

As used herein:

1. Life support devices or systems are devices or systems which, (a) are intended for surgical implant into the body, or (b) support or sustain life, or (c) whose failure to perform when properly used in accordance with instructions for use provided in labelling can be reasonably expected to result in significant injury to the user.
2. A critical component is any component of a life support device or system whose failure to perform can be reasonably expected to cause the failure of the life support device or system, or to affect its safety or effectiveness.