



flow90CON 1

1200 V / 100 A

Topology features

- Three-phase Rectifier
- Brake Chopper
- Temperature sensor

Component features

- Easy paralleling
- Low turn-off losses
- Low collector emitter saturation voltage
- Positive temperature coefficient
- Short tail current

Housing features

- Base isolation: Al₂O₃
- 90° mounting angle between heatsink and PCB
- Screw-on heatsink mounting
- Clip-in PCB mounting
- Thermo-mechanical push-and-pull force relief
- Solder pin

Target applications

- Motor drives
- Servo drives

Types

- V23990-P719-G51-PM

flow90 1 housing

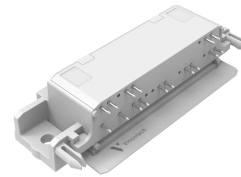

Schematic

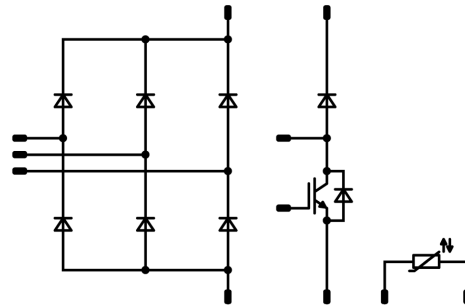



Vincotech

Maximum Ratings

$T_j = 25\text{ °C}$, unless otherwise specified

Parameter	Symbol	Conditions	Value	Unit
Brake Switch				
Collector-emitter voltage	V_{CES}		1200	V
Collector current (DC current)	I_C	$T_j = T_{jmax}$ $T_s = 80\text{ °C}$	63	A
Repetitive peak collector current	I_{CRM}	t_p limited by T_{jmax}	150	A
Total power dissipation	P_{tot}	$T_j = T_{jmax}$ $T_s = 80\text{ °C}$	167	W
Gate-emitter voltage	V_{GES}		± 20	V
Short circuit ratings	t_{SC}	$V_{GE} = 15\text{ V}$, $V_{CC} = 800\text{ V}$ $T_j = 150\text{ °C}$	10	μs
Maximum junction temperature	T_{jmax}		175	$^{\circ}\text{C}$

Brake Diode

Peak repetitive reverse voltage	V_{RRM}		1200	V
Forward current (DC current)	I_F	$T_j = T_{jmax}$ $T_s = 80\text{ °C}$	19	A
Repetitive peak forward current	I_{FRM}	t_p limited by T_{jmax}	30	A
Total power dissipation	P_{tot}	$T_j = T_{jmax}$ $T_s = 80\text{ °C}$	36	W
Maximum junction temperature	T_{jmax}		150	$^{\circ}\text{C}$

Brake Sw. Protection Diode

Peak repetitive reverse voltage	V_{RRM}		1200	V
Forward current (DC current)	I_F	$T_j = T_{jmax}$ $T_s = 80\text{ °C}$	10	A
Repetitive peak forward current	I_{FRM}	t_p limited by T_{jmax}	6	A
Total power dissipation	P_{tot}	$T_j = T_{jmax}$ $T_s = 80\text{ °C}$	25	W
Maximum junction temperature	T_{jmax}		150	$^{\circ}\text{C}$

**Maximum Ratings** $T_j = 25\text{ °C}$, unless otherwise specified

Parameter	Symbol	Conditions	Value	Unit
Rectifier Diode				
Peak repetitive reverse voltage	V_{RRM}		1600	V
Forward current (DC current)	I_F	$T_j = T_{jmax}$ $T_s = 80\text{ °C}$	88	A
Surge (non-repetitive) forward current	I_{FSM}	Single Half Sine Wave, $t_p = 10\text{ ms}$ $T_j = 150\text{ °C}$	1000	A
Surge current capability	I^2t		5000	A ² s
Total power dissipation	P_{tot}	$T_j = T_{jmax}$ $T_s = 80\text{ °C}$	107	W
Maximum junction temperature	T_{jmax}		150	°C

Module Properties**Thermal Properties**

Storage temperature	T_{stg}		-40...+125	°C
Operation temperature under switching condition	T_{jop}		-40...+($T_{jmax} - 25$)	°C

Isolation Properties

Isolation voltage	V_{isol}	DC Test Voltage* $t_p = 2\text{ s}$	6000	V
Isolation voltage	V_{isol}	AC Voltage $t_p = 1\text{ min}$	2500	V
Creepage distance			> 12,7	mm
Clearance			11,84	mm
Comparative Tracking Index	CTI		≥ 200	

*100 % tested in production



Characteristic Values

Parameter	Symbol	Conditions					Values			Unit
		V_{GE} [V] V_{GS} [V]	V_{CE} [V] V_{DS} [V] V_F [V]	I_C [A] I_D [A] I_F [A]	T_j [°C]	Min	Typ	Max		

Brake Switch

Static

Gate-emitter threshold voltage	$V_{GE(th)}$	$V_{CE} = V_{GE}$			0,0017	25	5,3	5,8	6,3	V
Collector-emitter saturation voltage	$V_{CE(sat)}$		15		50	25 125 150	1,58	1,83 2,12 2,18	2,07 ⁽¹⁾	V
Collector-emitter cut-off current	I_{CES}		0	1200		25			4,8	μA
Gate-emitter leakage current	I_{GES}		20	0		25			240	nA
Internal gate resistance	r_g							None		Ω
Input capacitance	C_{ies}	$f = 1 \text{ Mhz}$	0	25		25		2900		pF
Reverse transfer capacitance	C_{res}							100		pF
Gate charge	Q_g		±15		0	25		400		nC

Thermal

Thermal resistance junction to sink ⁽²⁾	$R_{th(j-s)}$	$\lambda_{paste} = 3,4 \text{ W/mK}$ (PSX)						0,57		K/W
--	---------------	---	--	--	--	--	--	------	--	-----

Dynamic

Turn-on delay time	$t_{d(on)}$	$R_{gon} = 4 \Omega$ $R_{goff} = 4 \Omega$	0/15	700	34	25		18,88		ns
						125		18,4		
Rise time	t_r					25		18,18		ns
						125		18,66		
Turn-off delay time	$t_{d(off)}$					25		251,11		ns
						125		325,19		
Fall time	t_f					25		66,14		ns
						125		121,68		
Turn-on energy (per pulse)	E_{on}	$Q_{tFWD} = 2,02 \mu\text{C}$ $Q_{tFWD} = 3,32 \mu\text{C}$				25		1,69		mWs
						125		2,17		
Turn-off energy (per pulse)	E_{off}					25		2,69		mWs
						125		4,22		



Characteristic Values

Parameter	Symbol	Conditions					Values			Unit
		V_{GE} [V] V_{GS} [V]	V_{CE} [V] V_{DS} [V] V_F [V]	I_C [A] I_D [A] I_F [A]	T_j [°C]	Min	Typ	Max		

Brake Diode

Static

Forward voltage	V_F				15	25 125	1,23	1,76 1,73	1,97 ⁽¹⁾	V
Reverse leakage current	I_R	$V_r = 1200$ V				25			27	μA

Thermal

Thermal resistance junction to sink ⁽²⁾	$R_{th(j-s)}$	$\lambda_{paste} = 3,4$ W/mK (PSX)						1,92		K/W
--	---------------	---------------------------------------	--	--	--	--	--	------	--	-----

Dynamic

Peak recovery current	I_{RRM}	$di/dt=1198$ A/μs $di/dt=1307$ A/μs	0/15	700	34	25		17,7		A
	125						22,41			
Reverse recovery time	t_{rr}					25		296,82		ns
	125						426,78			
Recovered charge	Q_r					25		2,02		μC
	125		3,32							
Reverse recovered energy	E_{rec}	25		1,04		mWs				
	125		1,75							
Peak rate of fall of recovery current	$(di/dt)_{max}$	25		161,63		A/μs				
	125		200,69							

Brake Sw. Protection Diode

Static

Forward voltage	V_F				3	25 125	1,23	1,61 1,58	1,97 ⁽¹⁾	V
Reverse leakage current	I_R	$V_r = 1200$ V				25			27	μA

Thermal

Thermal resistance junction to sink ⁽²⁾	$R_{th(j-s)}$	$\lambda_{paste} = 3,4$ W/mK (PSX)						2,8		K/W
--	---------------	---------------------------------------	--	--	--	--	--	-----	--	-----



Vincotech

Characteristic Values

Parameter	Symbol	Conditions					Values			Unit
		V_{GE} [V] V_{GS} [V]	V_{CE} [V] V_{DS} [V] V_F [V]	I_C [A] I_D [A] I_F [A]	T_j [°C]	Min	Typ	Max		

Rectifier Diode

Static

Forward voltage	V_F				150	25 125 150		1,43 1,47	1,31 ⁽¹⁾ 1,28 ⁽¹⁾	V
Reverse leakage current	I_R	$V_T = 1600$ V				25 150			50 2000	μA

Thermal

Thermal resistance junction to sink ⁽²⁾	$R_{th(j-s)}$	$\lambda_{paste} = 3,4$ W/mK (PSX)						0,65		K/W
--	---------------	---------------------------------------	--	--	--	--	--	------	--	-----

Thermistor

Static

Rated resistance	R					25		21,5		kΩ
Deviation of R_{100}	$\Delta_{R/R}$	$R_{100} = 1486$ Ω				100	-4,5		4,5	%
Power dissipation	P							210		mW
Power dissipation constant	d					25		3,5		mW/K
B-value	$B_{(25/50)}$							3884		K
B-value	$B_{(25/100)}$	Tol. ±1 %						3964		K
Vincotech Thermistor Reference									F	

⁽¹⁾ Value at chip level

⁽²⁾ Only valid with pre-applied Vincotech thermal interface material.



Brake Switch Characteristics

figure 1. IGBT

Typical output characteristics

$$I_C = f(V_{CE})$$

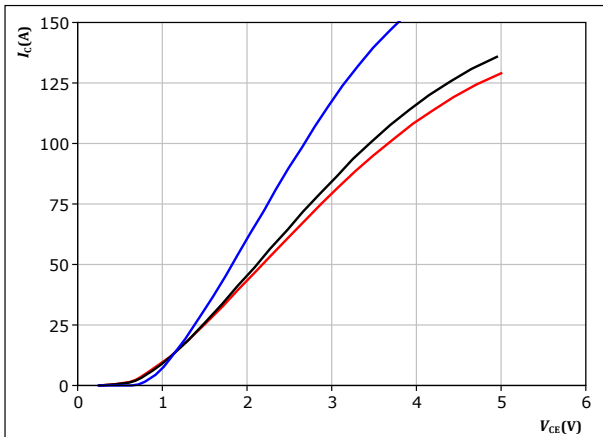

$t_p = 250 \mu s$
 $V_{GE} = 15 V$

T_j :
— 25 °C
— 125 °C
— 150 °C

figure 2. IGBT

Typical output characteristics

$$I_C = f(V_{CE})$$

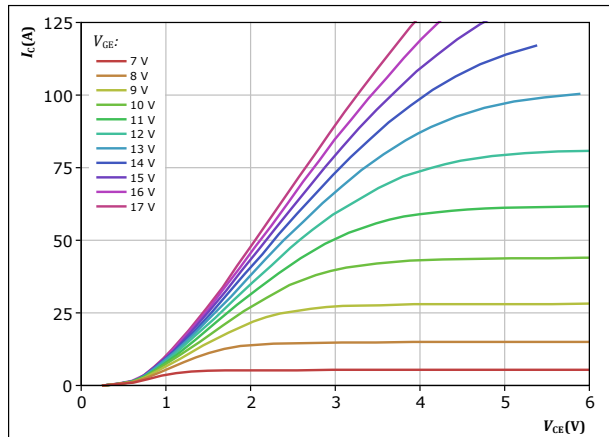

$t_p = 250 \mu s$
 $T_j = 150 \text{ }^\circ C$
 V_{GE} from 7 V to 17 V in steps of 1 V

figure 3. IGBT

Typical transfer characteristics

$$I_C = f(V_{GE})$$

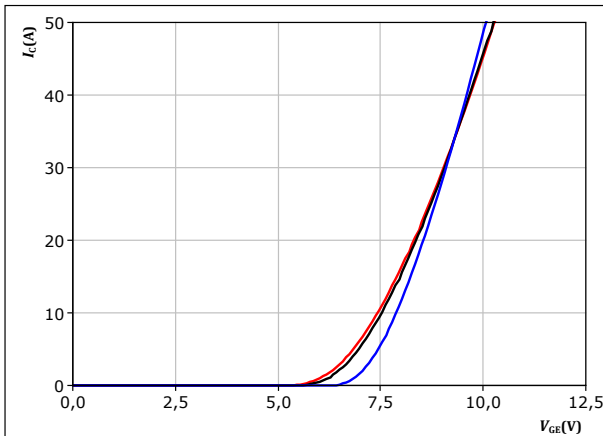

$t_p = 250 \mu s$
 $V_{CE} = 10 V$

T_j :
— 25 °C
— 125 °C
— 150 °C

figure 4. IGBT

Transient thermal impedance as a function of pulse width

$$Z_{th(j-s)} = f(t_p)$$

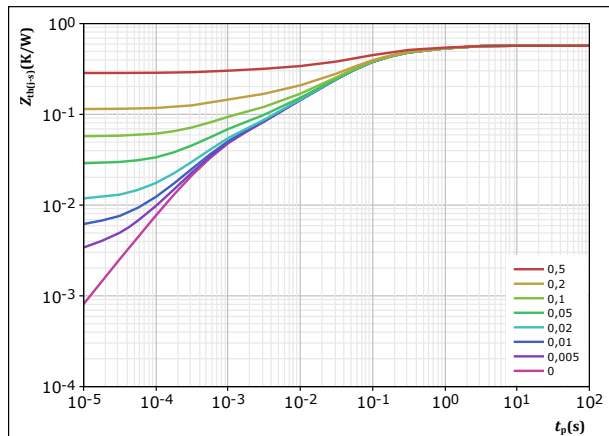

$D = t_p / T$
 $R_{th(j-s)} = 0,57 \text{ K/W}$

IGBT thermal model values

R (K/W)	τ (s)
9,44E-02	1,07E+00
1,78E-01	1,41E-01
1,93E-01	4,28E-02
6,30E-02	6,87E-03
4,25E-02	6,37E-04



Brake Switch Characteristics

figure 5. IGBT

Safe operating area

$$I_C = f(V_{CE})$$

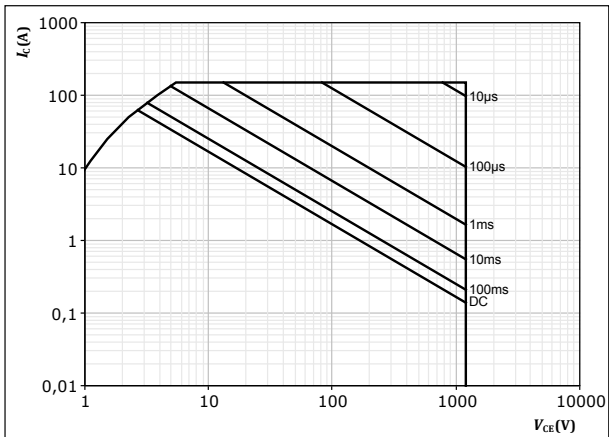

$D =$ single pulse
 $T_s = 80 \text{ } ^\circ\text{C}$
 $V_{GE} = 15 \text{ V}$
 $T_j = T_{jmax}$



Brake Diode Characteristics

figure 6. FWD

Typical forward characteristics

$$I_F = f(V_F)$$

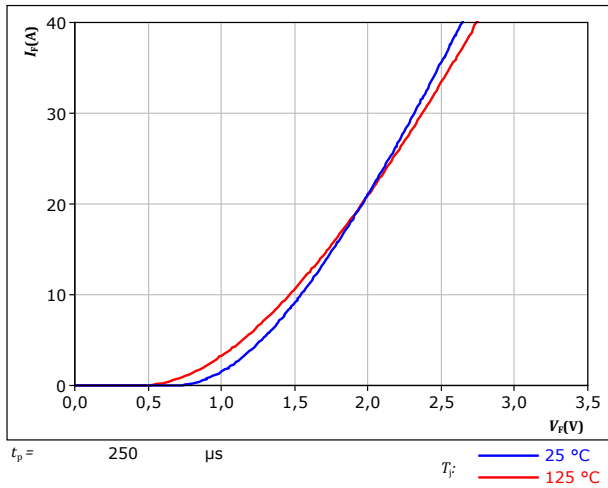
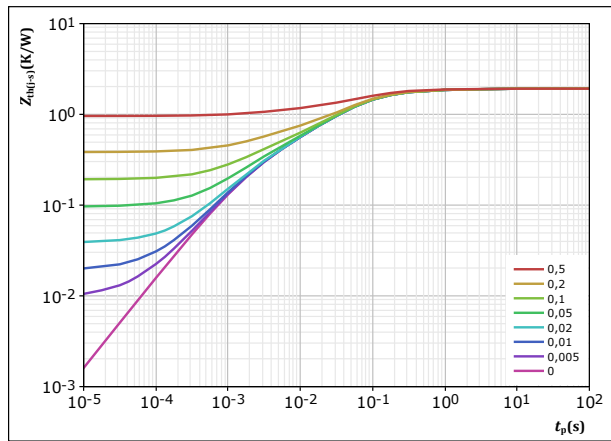

figure 7. FWD

Transient thermal impedance as a function of pulse width

$$Z_{th(j-s)} = f(t_p)$$



$D =$	t_p / T	
$R_{th(j-s)} =$	1,92	K/W
FWD thermal model values		
R (K/W)	τ (s)	
7,59E-02	2,86E+00	
2,78E-01	2,85E-01	
1,06E+00	5,95E-02	
3,35E-01	9,57E-03	
1,71E-01	1,60E-03	



Brake Sw. Protection Diode Characteristics

figure 8. FWD

Typical forward characteristics

$$I_F = f(V_F)$$

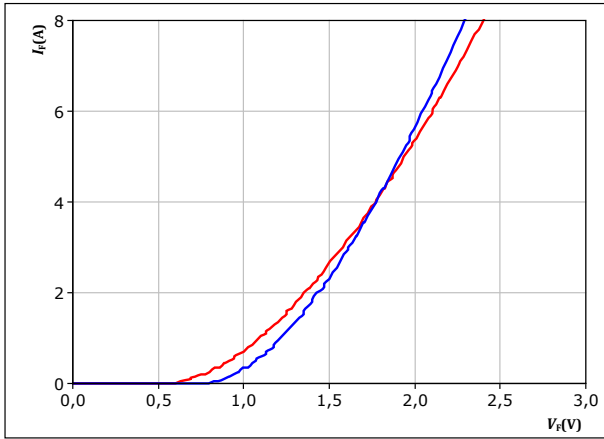

$t_p = 250\ \mu\text{s}$
 T_j : — 25 °C
 — 125 °C

figure 9. FWD

Transient thermal impedance as a function of pulse width

$$Z_{th(j-s)} = f(t_p)$$

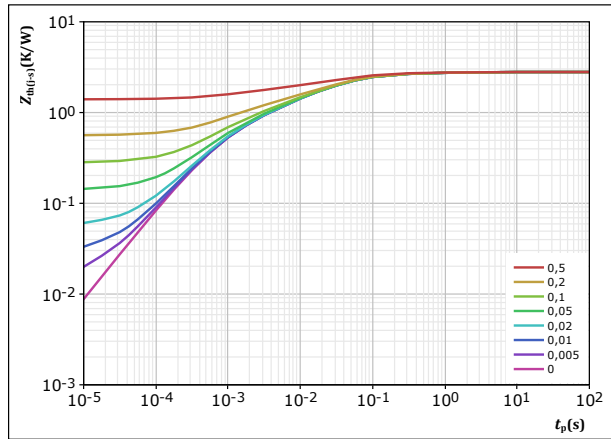

$D = t_p / T$
 $R_{th(j-s)} = 2,796\ \text{K/W}$
 FWD thermal model values

R (K/W)	τ (s)
7,82E-02	2,45E+00
1,95E-01	2,65E-01
9,84E-01	4,77E-02
6,58E-01	1,23E-02
5,09E-01	2,70E-03
3,71E-01	5,98E-04



Rectifier Diode Characteristics

figure 10. Rectifier

Typical forward characteristics

$$I_F = f(V_F)$$

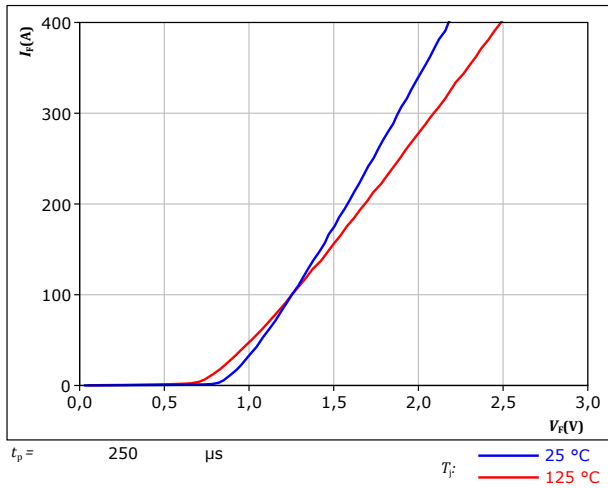
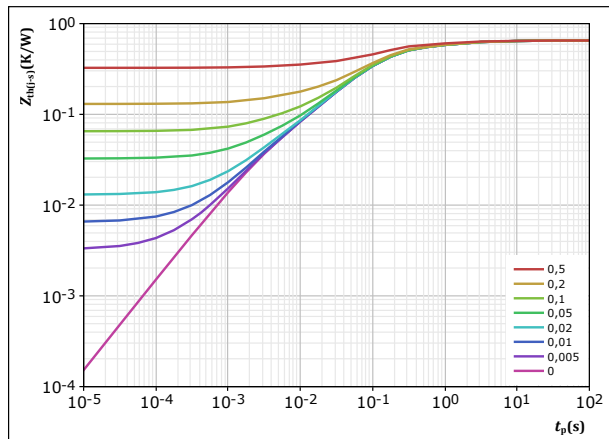

figure 11. Rectifier

Transient thermal impedance as a function of pulse width

$$Z_{th(j-s)} = f(t_p)$$



$D =$	t_p / T	
$R_{th(j-s)} =$	0,651	K/W
Rectifier thermal model values		
R (K/W)	τ (s)	
3,40E-02	6,74E+00	
1,24E-01	8,77E-01	
4,01E-01	1,13E-01	
6,55E-02	2,38E-02	
2,61E-02	2,98E-03	



Thermistor Characteristics

figure 12. Thermistor

Typical NTC characteristic as function of temperature

$$R_T = f(T)$$

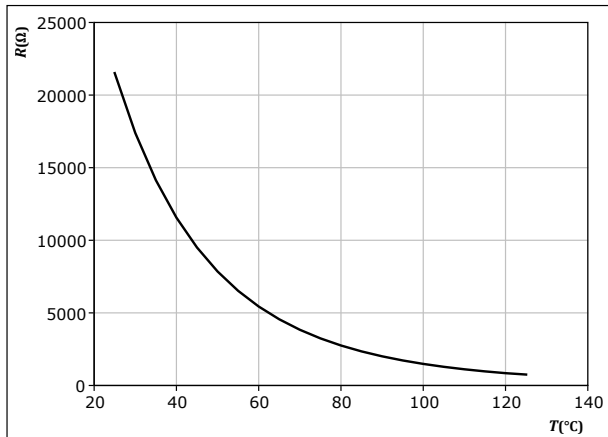



Brake Switching Characteristics

figure 13. IGBT

Typical switching energy losses as a function of collector current
 $E = f(I_c)$

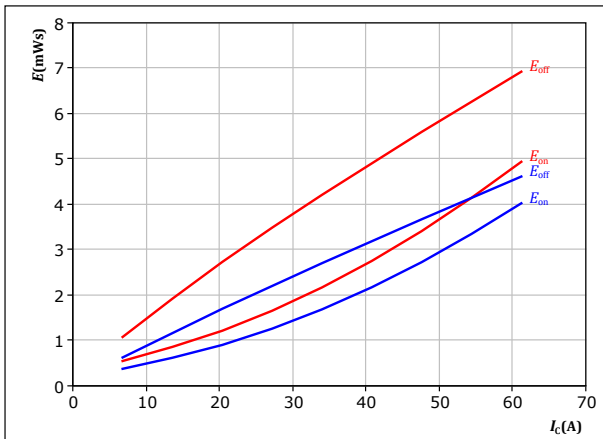

With an inductive load at
 $V_{CE} = 700 \text{ V}$
 $V_{GE} = 0/15 \text{ V}$
 $R_{gon} = 4 \text{ } \Omega$
 $R_{goff} = 4 \text{ } \Omega$
 T_j : — 25 °C
— 125 °C

figure 14. IGBT

Typical switching energy losses as a function of IGBT turn on gate resistor
 $E = f(R_g)$

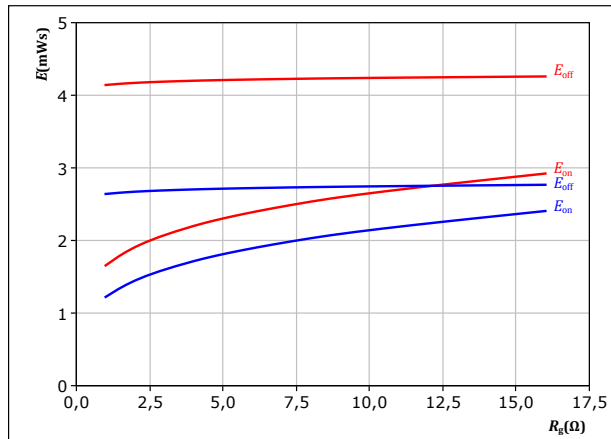

With an inductive load at
 $V_{CE} = 700 \text{ V}$
 $V_{GE} = 0/15 \text{ V}$
 $I_c = 34 \text{ A}$
 T_j : — 25 °C
— 125 °C

figure 15. FWD

Typical reverse recovered energy loss as a function of collector current
 $E_{rec} = f(I_c)$

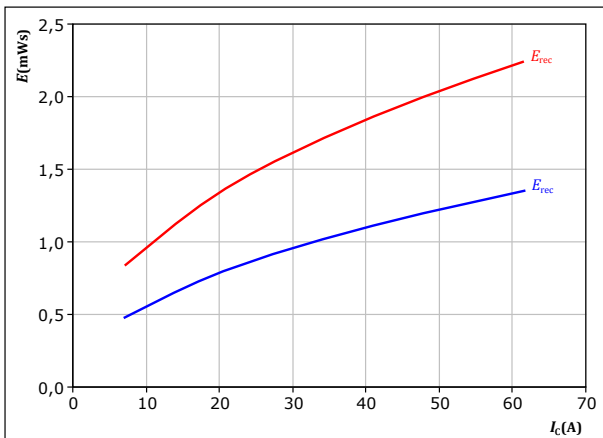

With an inductive load at
 $V_{CE} = 700 \text{ V}$
 $V_{GE} = 0/15 \text{ V}$
 $R_{gon} = 4 \text{ } \Omega$
 T_j : — 25 °C
— 125 °C

figure 16. FWD

Typical reverse recovered energy loss as a function of IGBT turn on gate resistor
 $E_{rec} = f(R_g)$

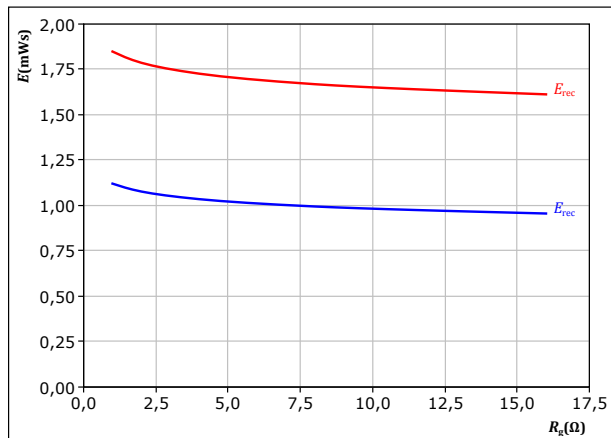

With an inductive load at
 $V_{CE} = 700 \text{ V}$
 $V_{GE} = 0/15 \text{ V}$
 $I_c = 34 \text{ A}$
 T_j : — 25 °C
— 125 °C



Brake Switching Characteristics

figure 17. IGBT

Typical switching times as a function of collector current
 $t = f(I_c)$

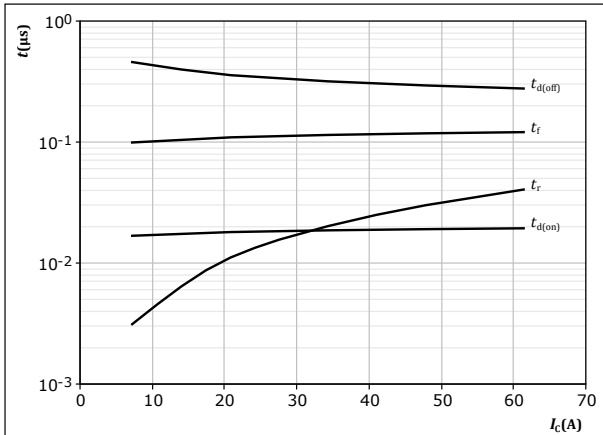

With an inductive load at
 $T_j = 125 \text{ }^\circ\text{C}$
 $V_{CE} = 700 \text{ V}$
 $V_{GE} = 0/15 \text{ V}$
 $R_{gon} = 4 \text{ } \Omega$
 $R_{goff} = 4 \text{ } \Omega$

figure 18. IGBT

Typical switching times as a function of IGBT turn on gate resistor
 $t = f(R_g)$

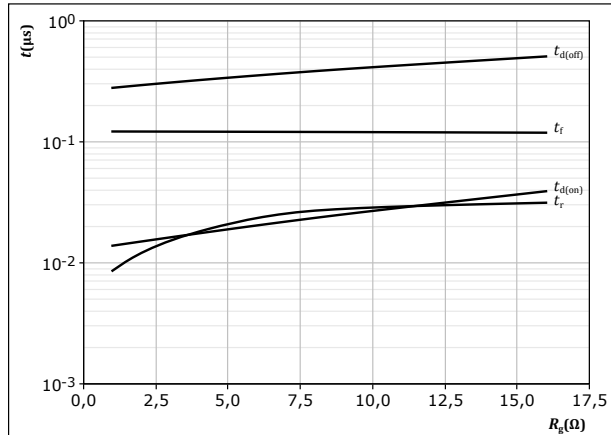

With an inductive load at
 $T_j = 125 \text{ }^\circ\text{C}$
 $V_{CE} = 700 \text{ V}$
 $V_{GE} = 0/15 \text{ V}$
 $I_c = 34 \text{ A}$

figure 19. FWD

Typical reverse recovery time as a function of collector current
 $t_{rr} = f(I_c)$

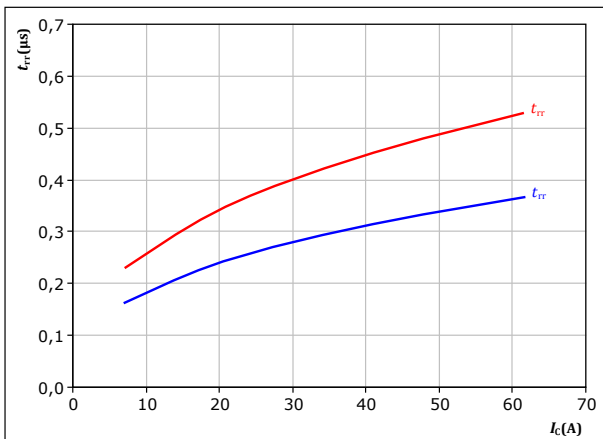

With an inductive load at
 $V_{CE} = 700 \text{ V}$
 $V_{GE} = 0/15 \text{ V}$
 $R_{gon} = 4 \text{ } \Omega$
 T_j : — 25 °C
 — 125 °C

figure 20. FWD

Typical reverse recovery time as a function of IGBT turn on gate resistor
 $t_{rr} = f(R_{gon})$

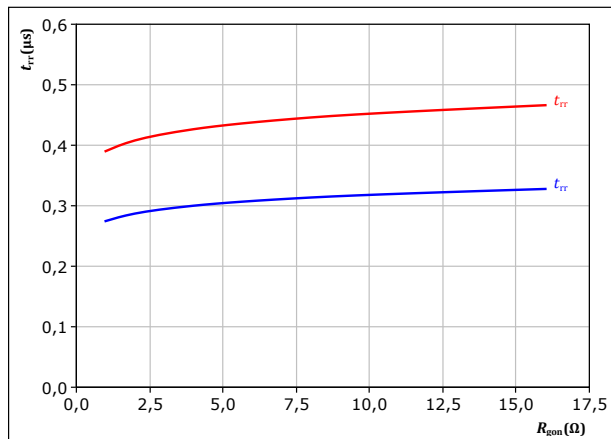

With an inductive load at
 $V_{CE} = 700 \text{ V}$
 $V_{GE} = 0/15 \text{ V}$
 $I_c = 34 \text{ A}$
 T_j : — 25 °C
 — 125 °C



Brake Switching Characteristics

figure 21. FWD

Typical recovered charge as a function of collector current

$$Q_r = f(I_c)$$

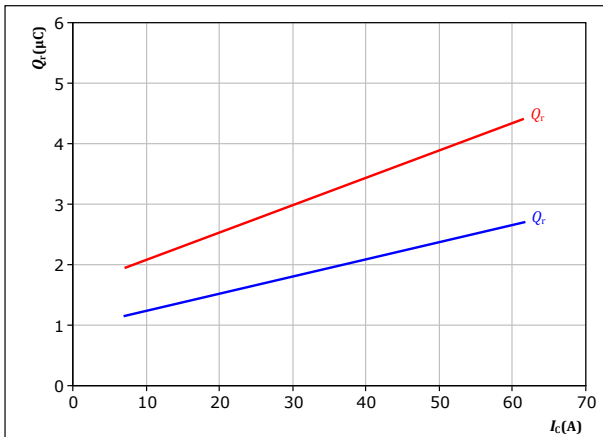

With an inductive load at

$V_{CE} = 700$ V
 $V_{GE} = 0/15$ V
 $R_{gon} = 4$ Ω

T_j : — 25 °C
— 125 °C

figure 22. FWD

Typical recovered charge as a function of IGBT turn on gate resistor

$$Q_r = f(R_{gon})$$

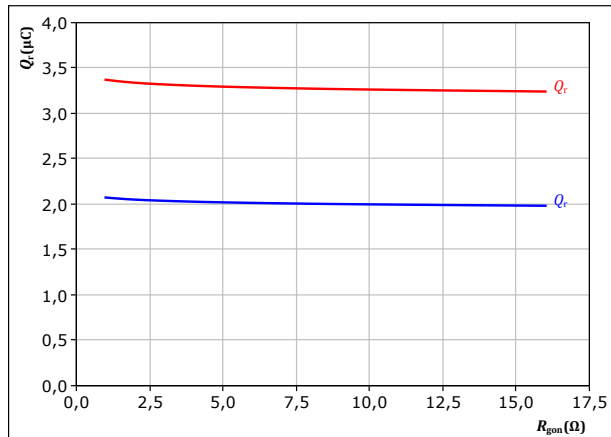

With an inductive load at

$V_{CE} = 700$ V
 $V_{GE} = 0/15$ V
 $I_c = 34$ A

T_j : — 25 °C
— 125 °C

figure 23. FWD

Typical peak reverse recovery current as a function of collector current

$$I_{RM} = f(I_c)$$

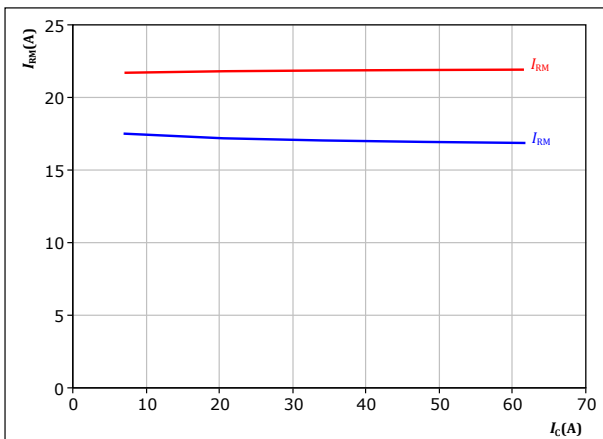

With an inductive load at

$V_{CE} = 700$ V
 $V_{GE} = 0/15$ V
 $R_{gon} = 4$ Ω

T_j : — 25 °C
— 125 °C

figure 24. FWD

Typical peak reverse recovery current as a function of IGBT turn on gate resistor

$$I_{RM} = f(R_{gon})$$

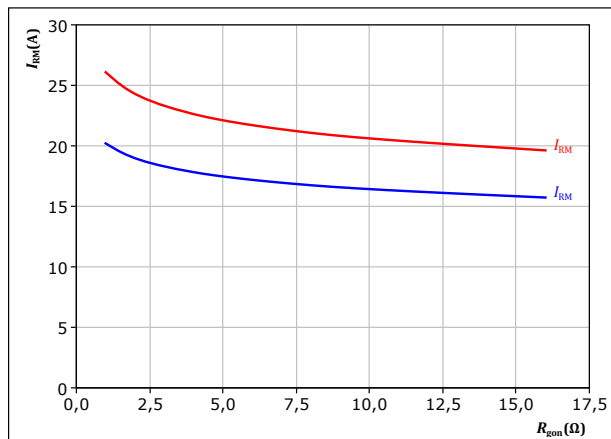

With an inductive load at

$V_{CE} = 700$ V
 $V_{GE} = 0/15$ V
 $I_c = 34$ A

T_j : — 25 °C
— 125 °C



Brake Switching Characteristics

figure 25. FWD

Typical rate of fall of forward and reverse recovery current as a function of collector current
 $di_f/dt, di_{rr}/dt = f(I_c)$

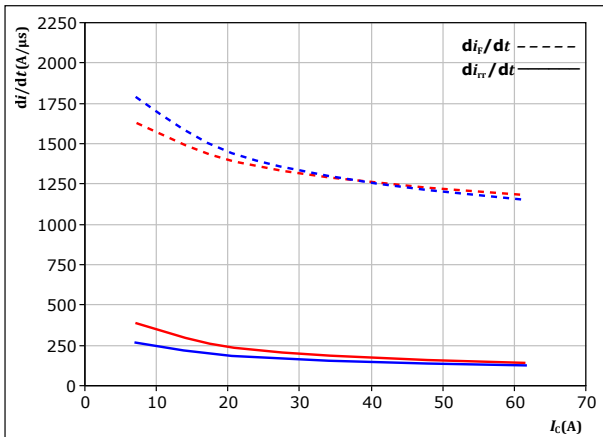

With an inductive load at
 $V_{CE} = 700 \text{ V}$
 $V_{GE} = 0/15 \text{ V}$
 $R_{gon} = 4 \ \Omega$

T_j : — 25 °C
 — 125 °C

figure 26. FWD

Typical rate of fall of forward and reverse recovery current as a function of turn on gate resistor
 $di_f/dt, di_{rr}/dt = f(R_{gon})$

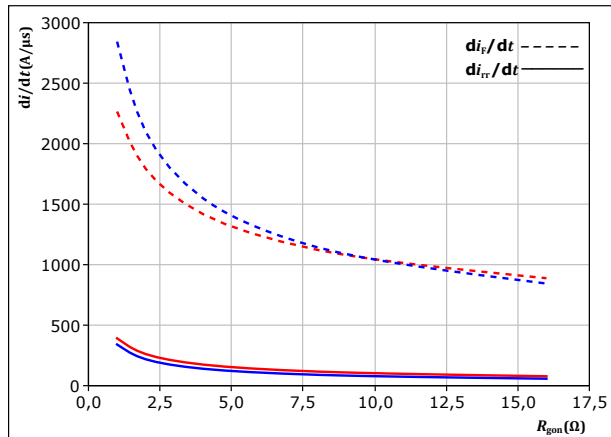

With an inductive load at
 $V_{CE} = 700 \text{ V}$
 $V_{GE} = 0/15 \text{ V}$
 $I_c = 34 \text{ A}$

T_j : — 25 °C
 — 125 °C

figure 27. IGBT

Reverse bias safe operating area
 $I_c = f(V_{CE})$

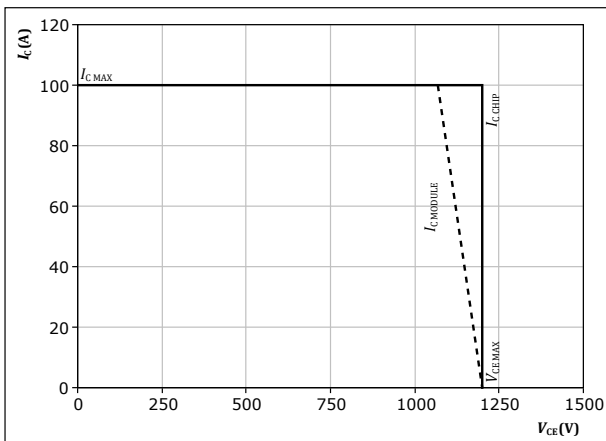

At $T_j = 125 \text{ °C}$
 $R_{gon} = 4 \ \Omega$
 $R_{goff} = 4 \ \Omega$



Brake Switching Definitions

figure 28. IGBT

Turn-off Switching Waveforms & definition of t_{doff} , t_{Eoff} (t_{Eoff} = integrating time for E_{off})

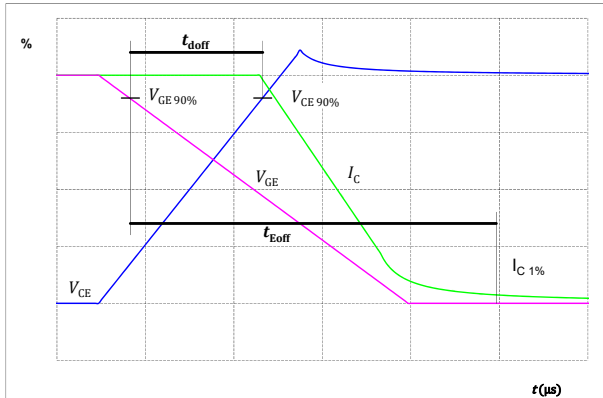

figure 29. IGBT

Turn-on Switching Waveforms & definition of t_{don} , t_{Eon} (t_{Eon} = integrating time for E_{on})



figure 30. IGBT

Turn-off Switching Waveforms & definition of t_f

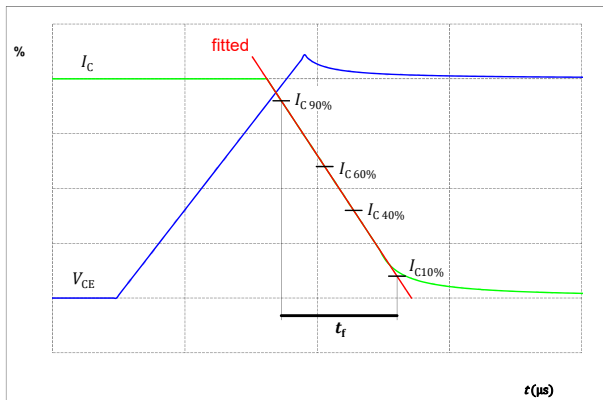
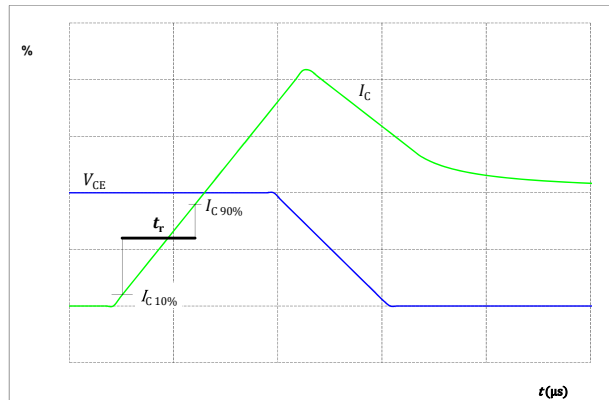

figure 31. IGBT

Turn-on Switching Waveforms & definition of t_r





Brake Switching Definitions

figure 32. FWD

Turn-off Switching Waveforms & definition of t_{rr}

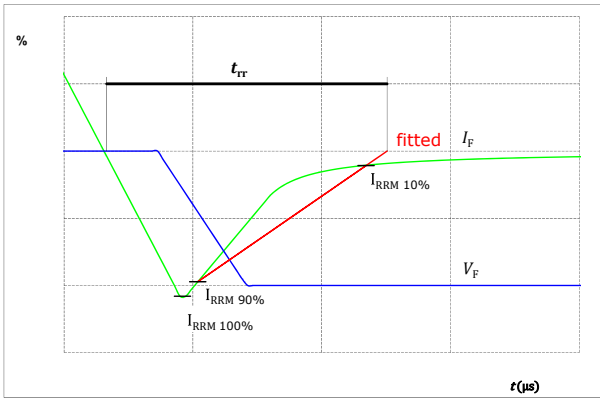
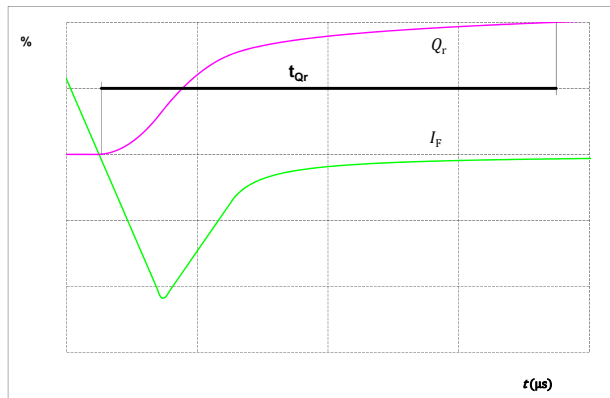

figure 33. FWD

Turn-on Switching Waveforms & definition of t_{Qr} (t_{Qr} = integrating time for Q_r)





Ordering Code	
Version	Ordering Code
Without thermal paste	V23990-P719-G51-PM
With thermal paste (3,4 W/mK, PSX-P7)	V23990-P719-G51-/3/-PM

Marking							
	Text	VIN	Date code	Type&Ver	UL	Lot	Serial
		VIN	WWYY	TTTTTTV	UL	LLLLL	SSSS
	Datamatrix	Type&Ver	Lot number	Serial	Date code		
		TTTTTTV	LLLLL	SSSS	WWYY		

Pin table [mm]			
Pin	X	Y	Function
1	53	0	L3
2	50,1	0	L3
3	47,2	0	NA
4	40,2	0	L1
5	37,3	0	L1
6	34,4	0	NA
7	27,4	0	NTC2
8	24,5	0	NTC1
9	21,6	0	NA
10	18,7	0	NA
11	15,8	0	DC+
12	12,9	0	DC+
13	7,1	0	Br+
14	0	0	BrC
15	0	7	BrE
16	3	7	BrG
17	7	7	NA
18	9,9	7	DC-
19	12,8	7	DC-
20	44	7	NA
21	47	7	L2
22	50	7	L2

Tolerance of positions: ±0.5mm at the end of pins
 Dimension of coordinate axis is only offset without tolerance

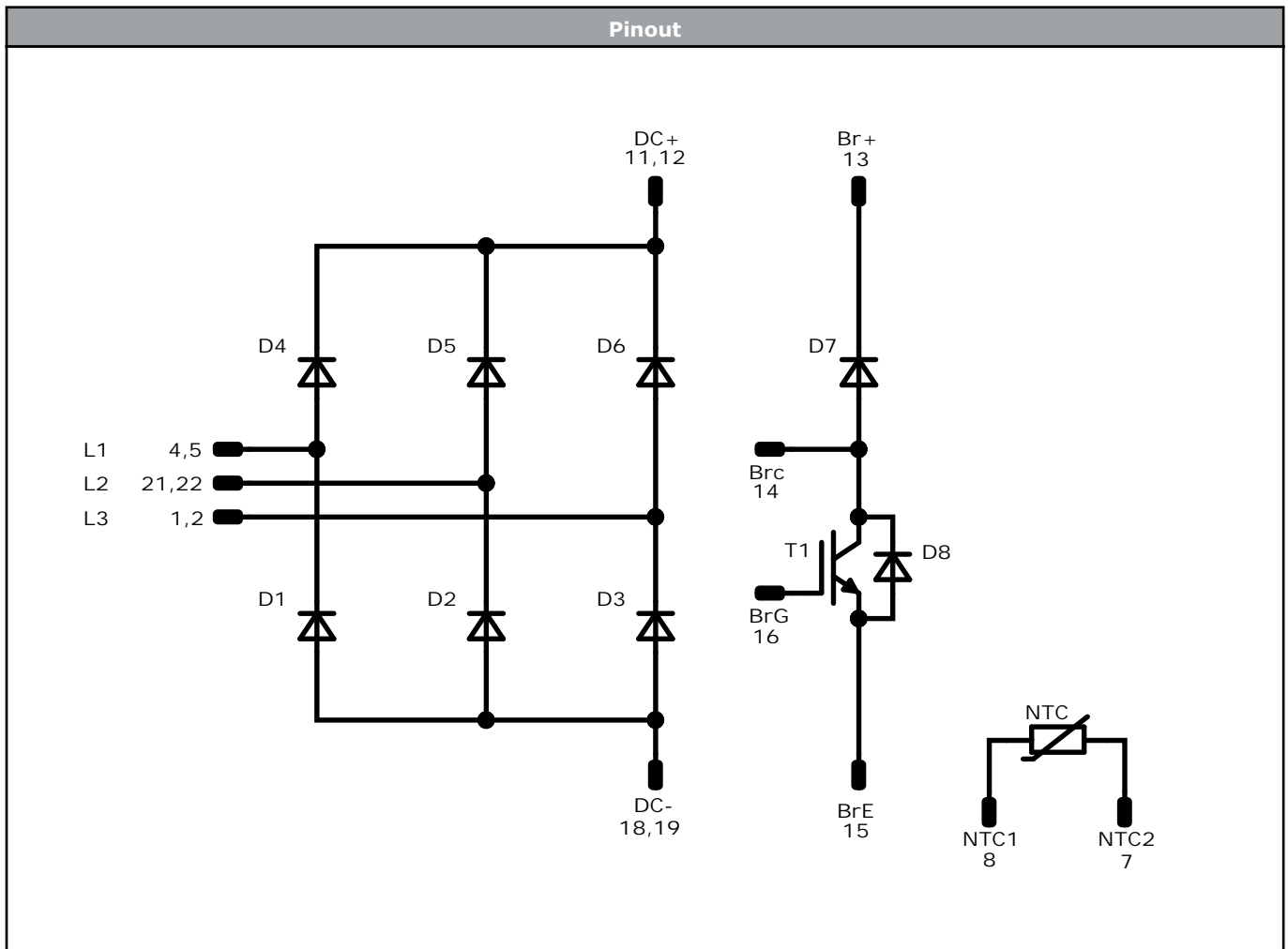

Identification					
ID	Component	Voltage	Current	Function	Comment
T1	IGBT	1200 V	50 A	Brake Switch	
D7	FWD	1200 V	15 A	Brake Diode	
D8	FWD	1200 V	3 A	Brake Sw. Protection Diode	
D1, D4, D2, D5, D3, D6	Rectifier	1600 V	150 A	Rectifier Diode	
NTC	Thermistor			Thermistor	



Packaging instruction				
Standard packaging quantity (SPQ) 80	>SPQ	Standard	<SPQ	Sample

Handling instruction
Handling instructions for <i>flow90</i> 1 packages see vincotech.com website.

Package data
Package data for <i>flow90</i> 1 packages see vincotech.com website.

Vincotech thermistor reference
See Vincotech thermistor reference table at vincotech.com website.

UL recognition and file number
This device is certified according to UL 1557 standard, UL file number E192116. For more information see vincotech.com website. 

Document No.:	Date:	Modification:	Pages
V23990-P719-G51-PM-D1-14	5 May. 2022		

DISCLAIMER

The information, specifications, procedures, methods and recommendations herein (together "information") are presented by Vincotech to reader in good faith, are believed to be accurate and reliable, but may well be incomplete and/or not applicable to all conditions or situations that may exist or occur. Vincotech reserves the right to make any changes without further notice to any products to improve reliability, function or design. No representation, guarantee or warranty is made to reader as to the accuracy, reliability or completeness of said information or that the application or use of any of the same will avoid hazards, accidents, losses, damages or injury of any kind to persons or property or that the same will not infringe third parties rights or give desired results. It is reader's sole responsibility to test and determine the suitability of the information and the product for reader's intended use.

LIFE SUPPORT POLICY

Vincotech products are not authorised for use as critical components in life support devices or systems without the express written approval of Vincotech.

As used herein:

1. Life support devices or systems are devices or systems which, (a) are intended for surgical implant into the body, or (b) support or sustain life, or (c) whose failure to perform when properly used in accordance with instructions for use provided in labelling can be reasonably expected to result in significant injury to the user.
2. A critical component is any component of a life support device or system whose failure to perform can be reasonably expected to cause the failure of the life support device or system, or to affect its safety or effectiveness.