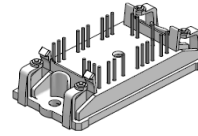
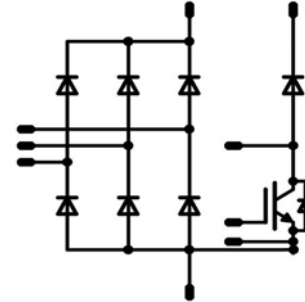

flowCON 0
1200V / 50A
Features

- Input rectifier
- Optionally with brake chopper
- Vincotech clip-in housing

flow0 housing

Target Applications

- Motor drives
- UPS

Schematic

Types

- V23990-P649-G-PM with brake chopper
- V23990-P649-H-PM without brake chopper

Maximum Ratings

Parameter	Symbol	Condition	Value	Unit
Input Rectifier Diode				
Repetitive peak reverse voltage	V_{RRM}	$T_j = T_{jmax}$	1600	V
Forward current per diode	I_{FAV}	DC current $T_j = T_{jmax}$ $T_h = 80^\circ\text{C}$	50	A
Surge forward current	I_{FSM}	$t_p = 10\text{ms}$ half sine wave $T_j = 45^\circ\text{C}$	600	A
I^2t -value	I^2t		1800	A^2s
Power dissipation per Diode	P_{tot}	$T_j = T_{jmax}$ $T_h = 80^\circ\text{C}$	60	W
Maximum junction temperature	T_{jmax}		150	$^\circ\text{C}$

Maximum Ratings

Parameter	Symbol	Condition	Value	Unit
Transistor BRC				
Collector-emitter break down voltage	V_{CE}		1200	V
DC collector current	I_C	$T_j = T_{jmax}$ $T_h = 80^\circ C$	25	A
Repetitive peak collector current	I_{cpuls}	t_p limited by T_{jmax}	75	A
Power dissipation per IGBT	P_{tot}	$T_j = T_{jmax}$ $T_h = 80^\circ C$	57	W
Gate-emitter peak voltage	V_{GE}		± 20	V
Short circuit ratings*	t_{SC} V_{CC}	$T_j \leq 150^\circ C$ $V_{GE} = 15V$	10 1200	μs V
Maximum junction temperature	T_{jmax}		150	$^\circ C$
* It is recommended to not exceed 1000 short circuit situations in the lifetime of the module and to allow at least 1s between short circuits				
BRC inverse diode				
Peak Repetitive Reverse Voltage	V_{RRM}	$T_j = 25^\circ C$	1200	V
DC forward current	I_F	$T_j = T_{jmax}$ $T_h = 80^\circ C$	6	A
Repetitive peak forward current	I_{FRM}	t_p limited by T_{jmax}	6	A
Power dissipation per Diode	P_{tot}	$T_j = T_{jmax}$ $T_h = 80^\circ C$	18	W
Maximum junction temperature	T_{jmax}		150	$^\circ C$
Diode BRC				
Peak Repetitive Reverse Voltage	V_{RRM}	$T_j = 25^\circ C$	1200	V
DC forward current	I_F	$T_j = T_{jmax}$ $T_h = 80^\circ C$	15	A
Repetitive peak forward current	I_{FRM}	t_p limited by T_{jmax}	30	A
Power dissipation per Diode	P_{tot}	$T_j = T_{jmax}$ $T_h = 80^\circ C$	33	W
Maximum junction temperature	T_{jmax}		150	$^\circ C$
Thermal properties				
Storage temperature	T_{stg}		-40...+125	$^\circ C$
Operation temperature	T_{op}		-40...+110	$^\circ C$

Maximum Ratings

Parameter	Symbol	Condition	Value	Unit
Insulation properties				
Insulation voltage	V_{is}	$t=2$ s Dc voltage	4000	V
Creepage distance			min 12.7	mm
Clearance			min 12.7	mm

Characteristic Values

Parameter	Symbol	Conditions					Value			Unit
		$V_{GE}(V)$ or $V_{ES}(V)$	$V_r(V)$ or $V_{CE}(V)$ or $V_{DS}(V)$	$I_c(A)$ or $I_f(A)$ or $I_b(A)$	$T(^{\circ}C)$	Min	Typ	Max		
Input Rectifier Bridge										
Forward voltage	V_F			50	$T_j=25^{\circ}C$ $T_j=125^{\circ}C$	1	1,14 1,09	1,5		V
Threshold voltage (for power loss calc. only)	V_{Io}				$T_j=25^{\circ}C$ $T_j=125^{\circ}C$		0,90 0,77			V
Slope resistance (for power loss calc. only)	r_t				$T_j=25^{\circ}C$ $T_j=125^{\circ}C$		5 7			m Ω
Reverse leakage current	I_r			1500	$T_j=25^{\circ}C$ $T_j=125^{\circ}C$			0,02 3		mA
Thermal resistance chip to heatsink per chip	R_{thJH}	Thermal grease thickness $\leq 50\mu m$ $\lambda = 0.61W/mK$						1,17		K/W
Thermal resistance chip to case per chip	R_{thJC}							n.A.		K/W
Transistor BRC										
Gate emitter threshold voltage	$V_{GE(th)}$	VCE=VGE			0,001	$T_j=25^{\circ}C$ $T_j=125^{\circ}C$	5	5,8	6,5	V
Collector-emitter saturation voltage	$V_{CE(sat)}$		15		25	$T_j=25^{\circ}C$ $T_j=125^{\circ}C$	1,3	1,63 1,84	2,2	V
Collector-emitter cut-off	I_{CES}		0	1200		$T_j=25^{\circ}C$ $T_j=125^{\circ}C$			0,25	mA
Gate-emitter leakage current	I_{GES}		20	0		$T_j=25^{\circ}C$ $T_j=125^{\circ}C$			650	nA
Integrated Gate resistor	R_{gint}							8		Ω
Turn-on delay time	$t_{d(on)}$	Rgon=32Ohm Rgoff=16Ohm	15	600	25	$T_j=25^{\circ}C$ $T_j=125^{\circ}C$		53		ns
Rise time	t_r					$T_j=25^{\circ}C$ $T_j=125^{\circ}C$		21		ns
Turn-off delay time	$t_{d(off)}$					$T_j=25^{\circ}C$ $T_j=125^{\circ}C$		617		ns
Fall time	t_f					$T_j=25^{\circ}C$ $T_j=125^{\circ}C$		183		ns
Turn-on energy loss per pulse	E_{on}					$T_j=25^{\circ}C$ $T_j=125^{\circ}C$		1,97		mWs
Turn-off energy loss per pulse	E_{off}					$T_j=25^{\circ}C$ $T_j=125^{\circ}C$		2,85		mWs
Input capacitance	C_{ies}	f=1MHz	0	25		$T_j=25^{\circ}C$		1,808		nF
Output capacitance	C_{oss}							0,095		nF
Reverse transfer capacitance	C_{rss}							0,082		nF
Gate charge	Q_{Gate}		15	960	25	$T_j=25^{\circ}C$		155		nC
Thermal resistance chip to heatsink per chip	R_{thJH}	Thermal grease thickness $\leq 50\mu m$ $\lambda = 0.61W/mK$						1,24		K/W
Thermal resistance chip to case per chip	R_{thJC}							n.A.		K/W

Characteristic Values

Parameter	Symbol	Conditions					Value			Unit
		$V_{GE}(V)$ or $V_{ES}(V)$	$V_r(V)$ or $V_{CE}(V)$ or $V_{DS}(V)$	$I_c(A)$ or $I_r(A)$ or $I_p(A)$	$T(^{\circ}C)$	Min	Typ	Max		
BRC inverse diode										
Diode forward voltage	V_F				3	$T_j=25^{\circ}C$ $T_j=125^{\circ}C$	1	1,65 1,58	2,3	V
Reverse leakage current	I_r			1200		$T_j=25^{\circ}C$ $T_j=125^{\circ}C$			250	μA
Thermal resistance chip to heatsink per chip	R_{thJH}	Thermal grease thickness $\leq 50\mu m$ $\lambda = 0.61W/mK$						3,8		K/W
Thermal resistance chip to case per chip	R_{thJC}							n.A.		K/W
Diode BRC										
Diode forward voltage	V_F				25	$T_j=25^{\circ}C$ $T_j=125^{\circ}C$	1	1,75 1,69	2,4	V
Reverse leakage current	I_r			1200		$T_j=25^{\circ}C$ $T_j=125^{\circ}C$			250	μA
Peak reverse recovery current	I_{RRM}	Rgon=32Ohm Rgoff=16Ohm	15	600	25	$T_j=25^{\circ}C$ $T_j=125^{\circ}C$		44,2		A
Reverse recovery time	t_{rr}					$T_j=25^{\circ}C$ $T_j=125^{\circ}C$		196		ns
Reverse recovered charge	Q_{rr}					$T_j=25^{\circ}C$ $T_j=125^{\circ}C$		3,44		μC
Peak rate of fall of reverse recovery current	$di(rec)max/dt$					$T_j=25^{\circ}C$ $T_j=125^{\circ}C$		2371		A/ μs
Reverse recovery energy	E_{rec}					$T_j=25^{\circ}C$ $T_j=125^{\circ}C$		1,34		mWs
Thermal resistance chip to heatsink per chip	R_{thJH}	Thermal grease thickness $\leq 50\mu m$ $\lambda = 0.61W/mK$						2,11		K/W
Thermal resistance chip to case per chip	R_{thJC}							n.A.		K/W

Brake

Figure 1 Brake IGBT

Typical output characteristics

$I_C = f(V_{CE})$

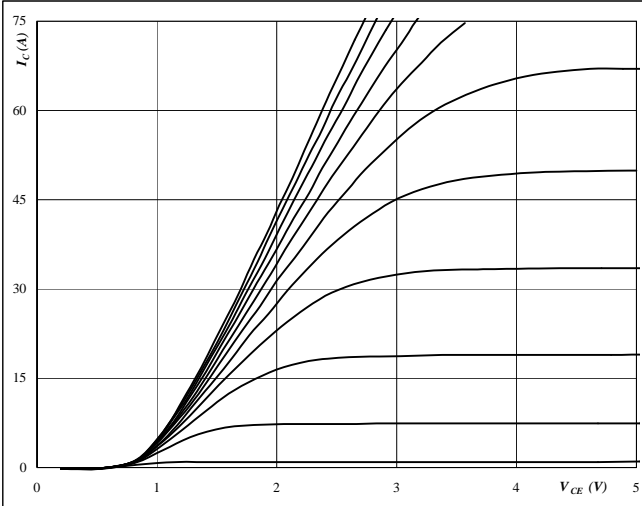

At

 $t_p = 250 \mu s$
 $T_j = 25 \text{ } ^\circ C$
 V_{GE} from 7 V to 17 V in steps of 1 V

Figure 2 Brake IGBT

Typical output characteristics

$I_C = f(V_{CE})$

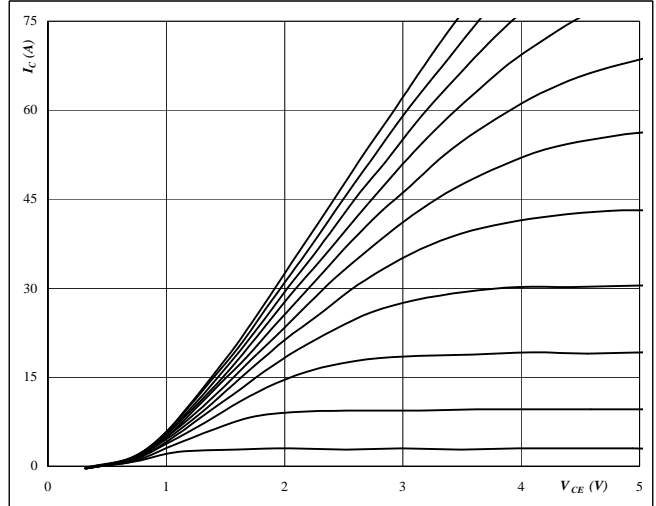

At

 $t_p = 250 \mu s$
 $T_j = 125 \text{ } ^\circ C$
 V_{GE} from 7 V to 17 V in steps of 1 V

Figure 3 Brake IGBT

Typical transfer characteristics

$I_C = f(V_{GE})$

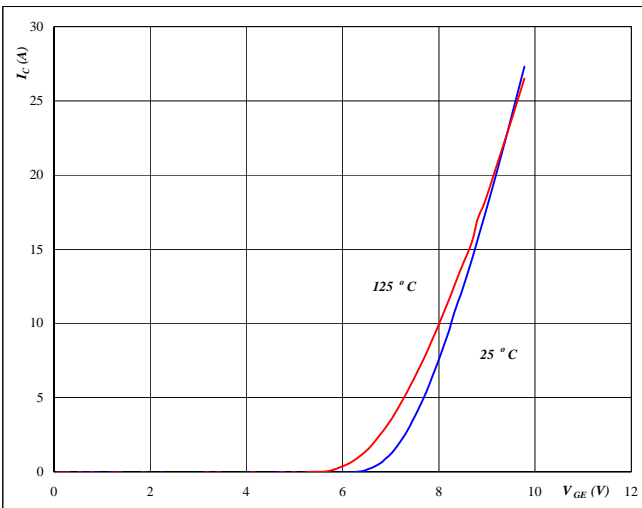

At

 $t_p = 250 \mu s$
 $V_{CE} = 10 \text{ V}$
Figure 4 Brake FRED

Typical diode forward current as a function of forward voltage

$I_F = f(V_F)$

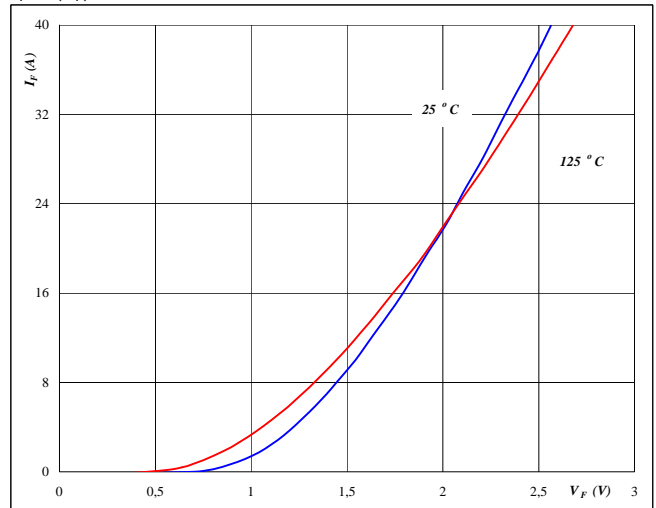

At

 $t_p = 250 \mu s$

Brake

Figure 5 Brake IGBT

Typical switching energy losses as a function of collector current

$$E = f(I_C)$$

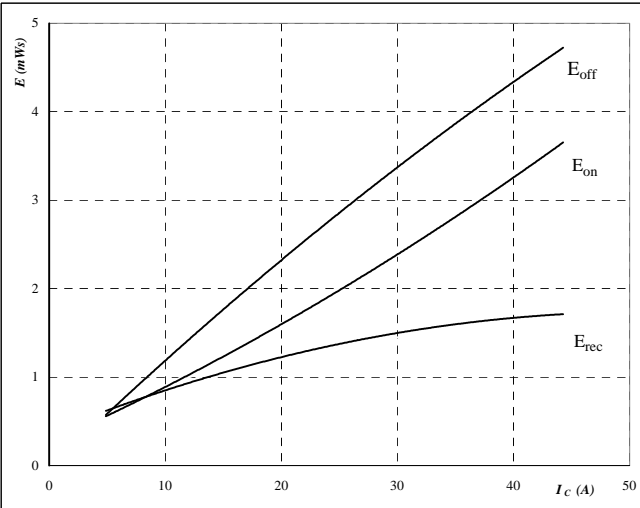

With an inductive load at

$T_j =$	125	°C
$V_{CE} =$	600	V
$V_{GE} =$	15	V
$R_{gon} =$	32	Ω
$R_{goff} =$	16	Ω

Figure 6 Brake IGBT

Typical switching energy losses as a function of gate resistor

$$E = f(R_G)$$

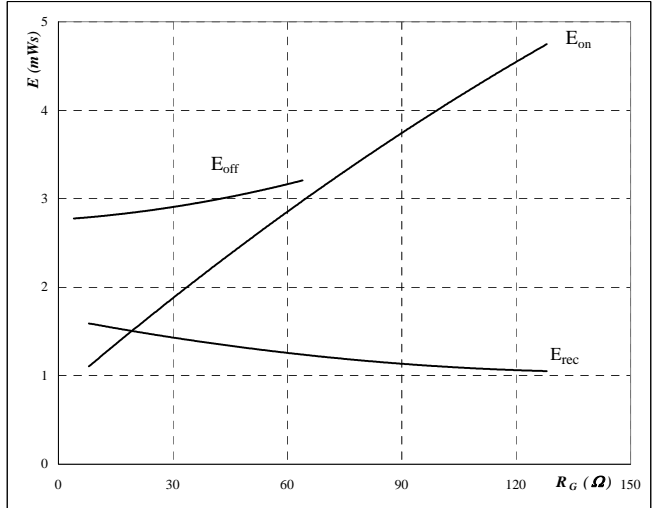

With an inductive load at

$T_j =$	125	°C
$V_{CE} =$	600	V
$V_{GE} =$	15	V
$I_C =$	24	A

Figure 7 Brake IGBT

Typical switching times as a function of collector current

$$t = f(I_C)$$

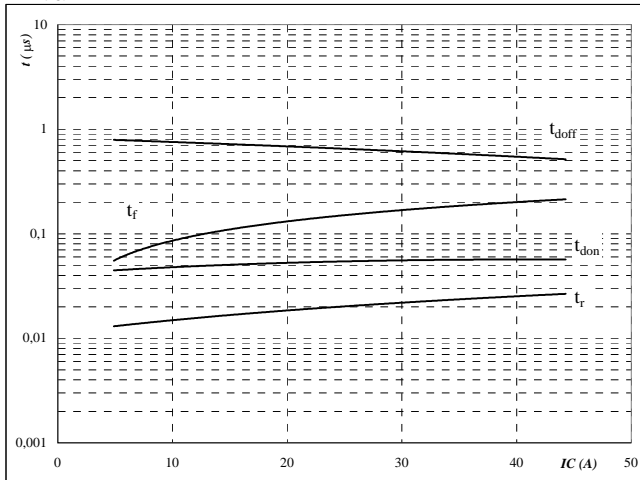

With an inductive load at

$T_j =$	125	°C
$V_{CE} =$	600	V
$V_{GE} =$	15	V
$R_{gon} =$	32	Ω
$R_{goff} =$	16	Ω

Figure 8 Brake IGBT

Typical switching times as a function of gate resistor

$$t = f(R_G)$$

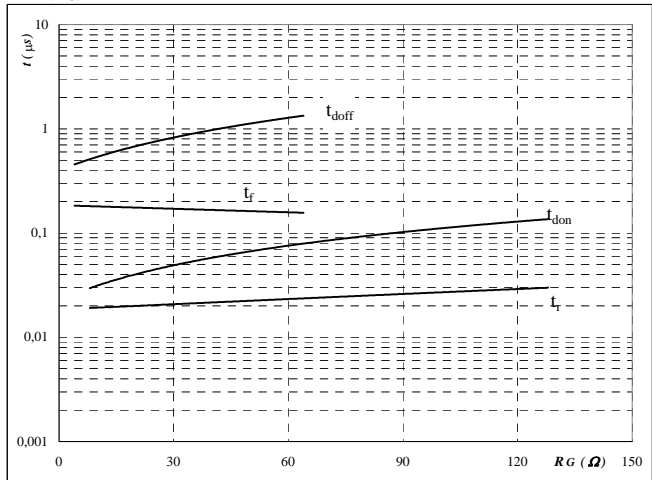

With an inductive load at

$T_j =$	125	°C
$V_{CE} =$	600	V
$V_{GE} =$	15	V
$I_C =$	24	A

Brake

Figure 9
IGBT transient thermal impedance as a function of pulse width

$$Z_{thJH} = f(t_p)$$

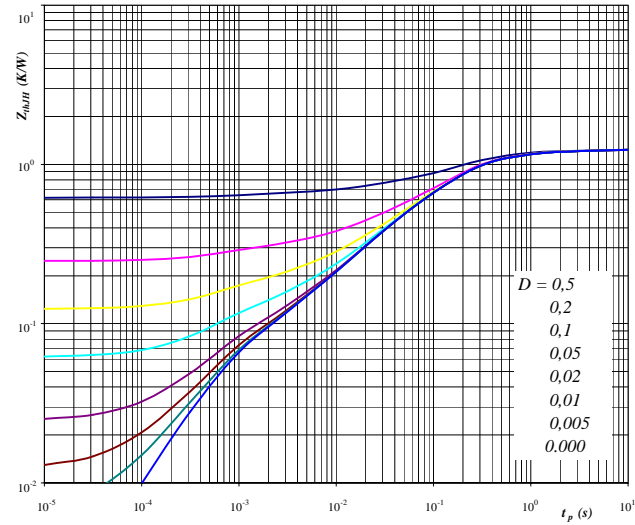

With

$$D = \frac{t_p}{T}$$

$$R_{thJH} = 1,24 \quad \text{K/W}$$

Figure 10
FRED transient thermal impedance as a function of pulse width

$$Z_{thJH} = f(t_p)$$

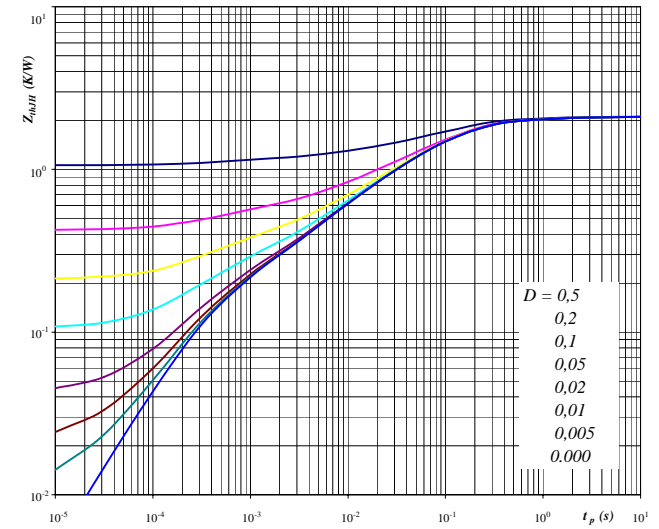

With

$$D = \frac{t_p}{T}$$

$$R_{thJH} = 2,11 \quad \text{K/W}$$

Brake

Figure 11 Brake IGBT

Power dissipation as a function of heatsink temperature

$$P_{tot} = f(T_h)$$



 At
 T_j = 150 °C

Figure 12 Brake IGBT

Collector current as a function of heatsink temperature

$$I_C = f(T_h)$$

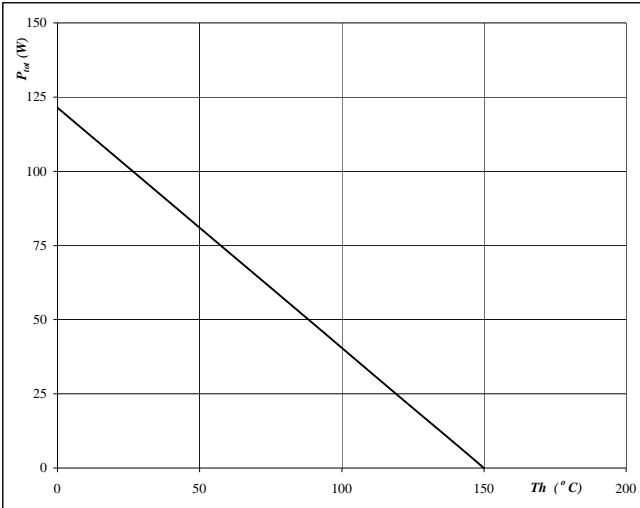

 At
 T_j = 150 °C
 V_{GE} = 15 V

Figure 13 Brake FRED

Power dissipation as a function of heatsink temperature

$$P_{tot} = f(T_h)$$

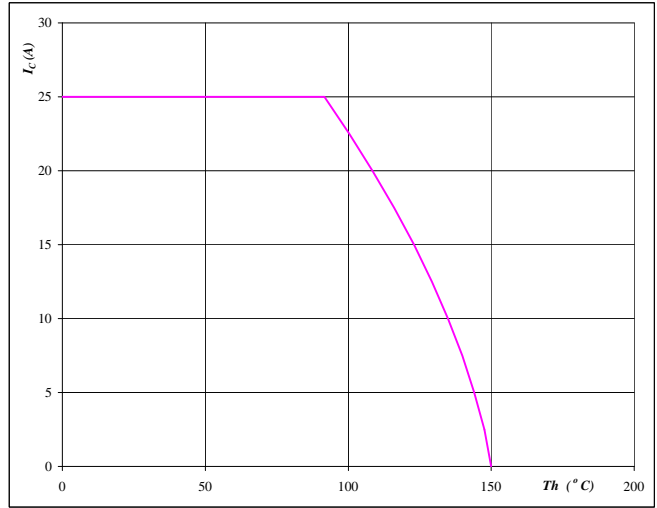

 At
 T_j = 150 °C

Figure 14 Brake FRED

Forward current as a function of heatsink temperature

$$I_F = f(T_h)$$

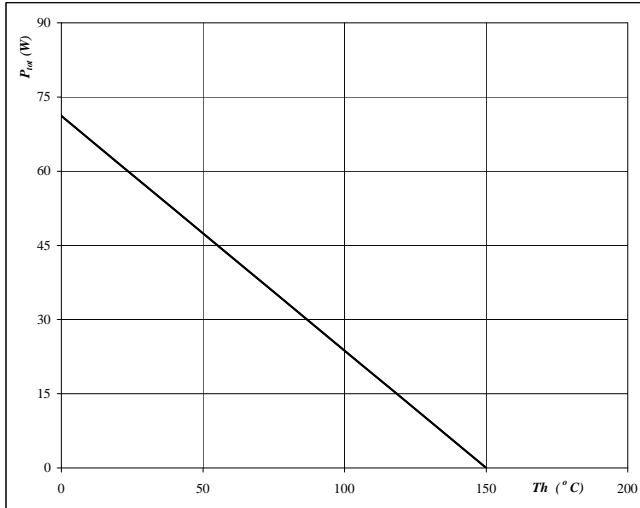
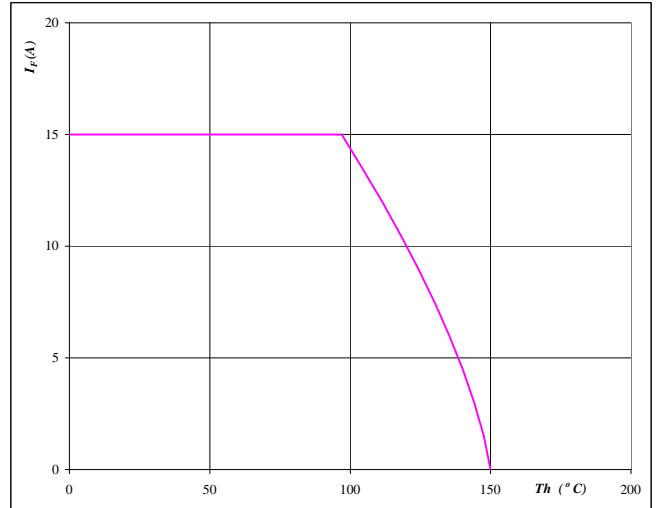

 At
 T_j = 150 °C

Brake Inverse Diode

Figure 1 Brake inverse diode

Typical diode forward current as a function of forward voltage

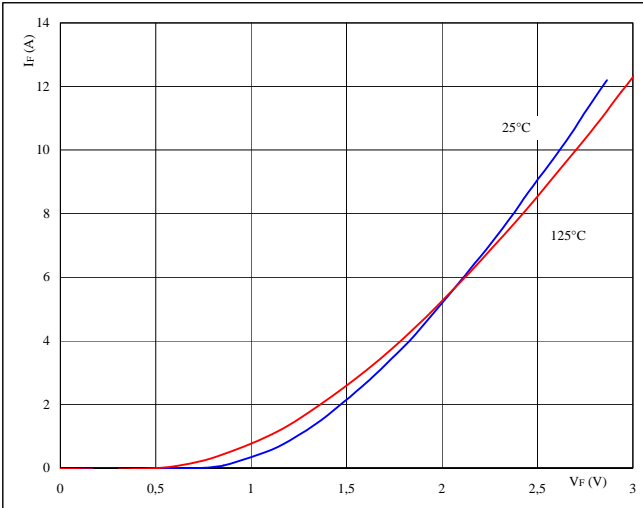
$$I_F = f(V_F)$$



At
 $t_p = 250 \mu s$

Figure 2 Brake inverse diode

Diode transient thermal impedance as a function of pulse width

$$Z_{thJH} = f(t_p)$$

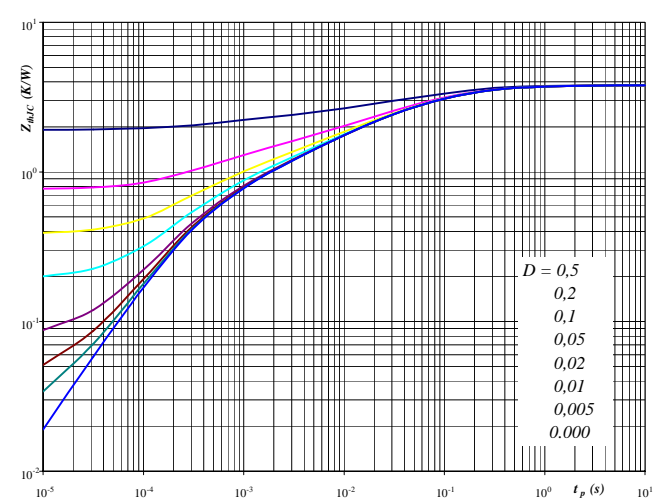

With
 $D = t_p / T$
 $R_{thJH} = 3,80 \text{ K/W}$

Figure 3 Brake inverse diode

Power dissipation as a function of heatsink temperature

$$P_{tot} = f(T_h)$$

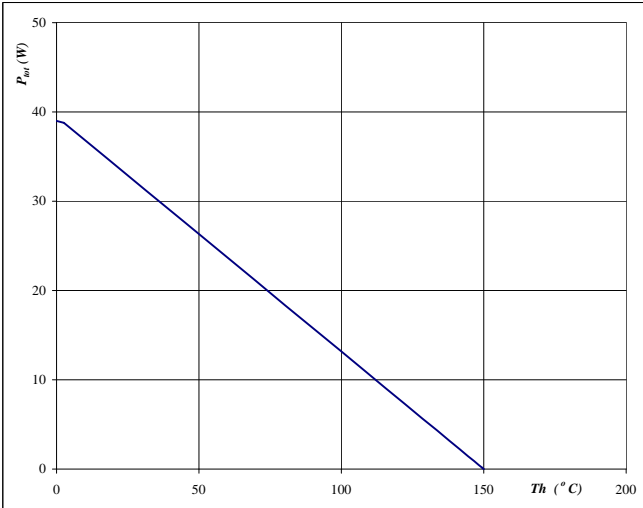

At
 $T_j = 150 \text{ }^\circ\text{C}$

Figure 4 Brake inverse diode

Forward current as a function of heatsink temperature

$$I_F = f(T_h)$$

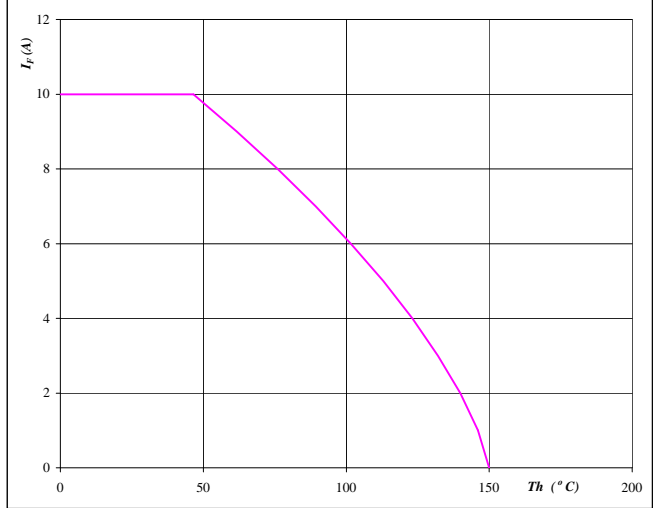

At
 $T_j = 150 \text{ }^\circ\text{C}$

Input Rectifier Bridge

Figure 1 Rectifier diode

Typical diode forward current as a function of forward voltage

$$I_F = f(V_F)$$

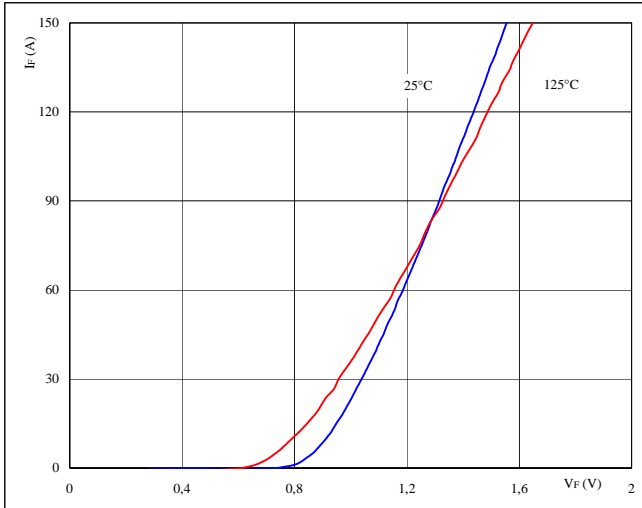
 At
 $t_p = 250 \mu s$
Figure 2 Rectifier diode

Diode transient thermal impedance as a function of pulse width

$$Z_{thJH} = f(t_p)$$

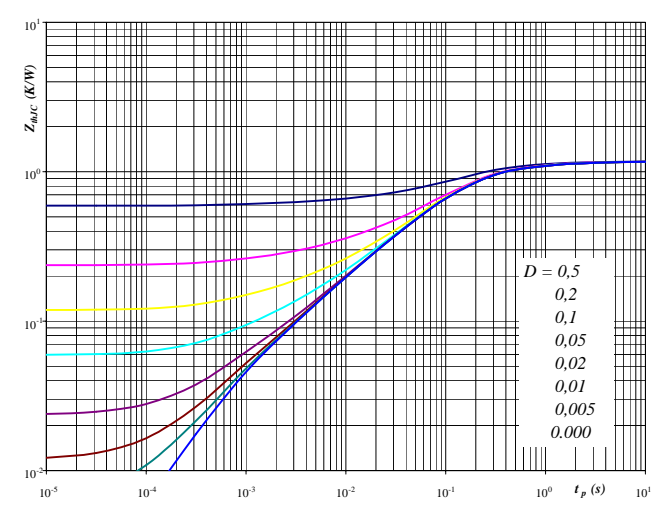
 With
 $D = t_p / T$
 $R_{thJH} = 1,17 \text{ K/W}$
Figure 3 Rectifier diode

Power dissipation as a function of heatsink temperature

$$P_{tot} = f(T_h)$$

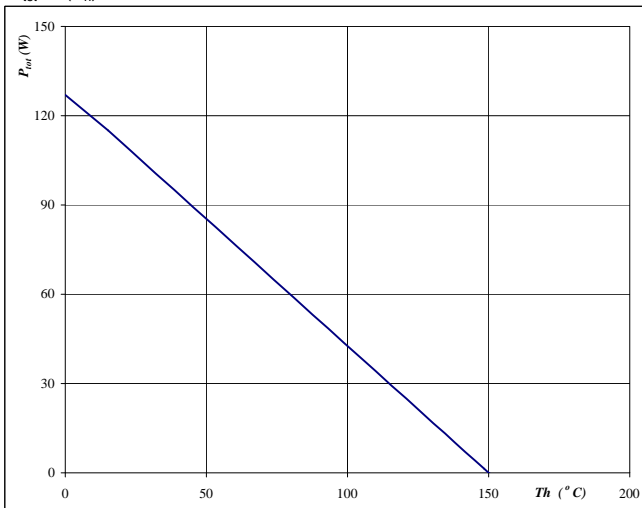
 At
 $T_j = 150 \text{ }^\circ\text{C}$
Figure 4 Rectifier diode

Forward current as a function of heatsink temperature

$$I_F = f(T_h)$$

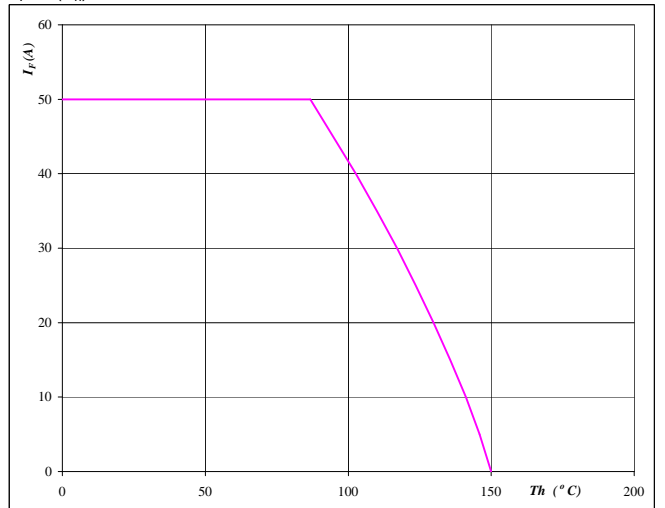
 At
 $T_j = 150 \text{ }^\circ\text{C}$

PRODUCT STATUS DEFINITIONS

Datasheet Status	Product Status	Definition
Target	Formative or In Design	This datasheet contains the design specifications for product development. Specifications may change in any manner without notice. The data contained is exclusively intended for technically trained staff.
Preliminary	First Production	This datasheet contains preliminary data, and supplementary data may be published at a later date. Vincotech reserves the right to make changes at any time without notice in order to improve design. The data contained is exclusively intended for technically trained staff.
Final	Full Production	This datasheet contains final specifications. Vincotech reserves the right to make changes at any time without notice in order to improve design. The data contained is exclusively intended for technically trained staff.

DISCLAIMER

Vincotech reserves the right to make changes without further notice to any products herein to improve reliability, function or design. Vincotech does not assume any liability arising out of the application or use of any product or circuit described herein; neither does it convey any license under its patent rights, nor the rights of others.

LIFE SUPPORT POLICY

Vincotech products are not authorised for use as critical components in life support devices or systems without the express written approval of Vincotech.

As used herein:

1. Life support devices or systems are devices or systems which, (a) are intended for surgical implant into the body, or (b) support or sustain life, or (c) whose failure to perform when properly used in accordance with instructions for use provided in labelling can be reasonably expected to result in significant injury to the user.
2. A critical component is any component of a life support device or system whose failure to perform can be reasonably expected to cause the failure of the life support device or system, or to affect its safety or effectiveness.