

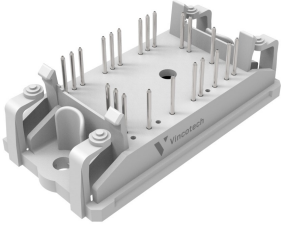
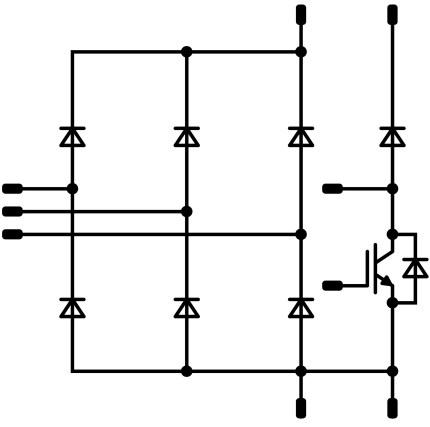

Vincotech

<i>flowCON 0</i>	1600 V / 75 A
<div style="background-color: #eee; padding: 5px; margin-bottom: 10px;">Features</div> <ul style="list-style-type: none"> Three-phase input rectifier Brake chopper 	<div style="background-color: #eee; padding: 5px; margin-bottom: 10px;"><i>flow 0 17 mm housing</i></div> 
<div style="background-color: #eee; padding: 5px; margin-bottom: 10px;">Target applications</div> <ul style="list-style-type: none"> Industrial Drives Embedded Drives UPS 	<div style="background-color: #eee; padding: 5px; margin-bottom: 10px;">Schematic</div> 
<div style="background-color: #eee; padding: 5px; margin-bottom: 10px;">Types</div> <ul style="list-style-type: none"> V23990-P640-G-PM 	

Maximum Ratings

$T_j = 25\text{ °C}$, unless otherwise specified

Parameter	Symbol	Condition	Value	Unit
Rectifier Diode				
Peak repetitive reverse voltage	V_{RRM}		1600	V
Continuous (direct) forward current	I_F	$T_j = T_{jmax}$ $T_s = 80\text{ °C}$	78	A
Surge (non-repetitive) forward current	I_{FSM}	50 Hz Single Half Sine Wave $t_p = 10\text{ ms}$ $T_j = 150\text{ °C}$	740	A
Surge current capability	I^2t		2740	A ² s
Total power dissipation	P_{tot}	$T_j = T_{jmax}$ $T_s = 80\text{ °C}$	88	W
Maximum junction temperature	T_{jmax}		150	°C



Vincotech

Maximum Ratings

$T_j = 25\text{ °C}$, unless otherwise specified

Parameter	Symbol	Condition	Value	Unit
Brake Switch				
Collector-emitter voltage	V_{CES}		1200	V
Collector current	I_C	$T_j = T_{jmax}$ $T_s = 80\text{ °C}$	35	A
Repetitive peak collector current	I_{CRM}	t_p limited by T_{jmax}	70	A
Total power dissipation	P_{tot}	$T_j = T_{jmax}$ $T_s = 80\text{ °C}$	72	W
Gate-emitter voltage	V_{GES}		± 20	V
Maximum junction temperature	T_{jmax}		150	°C
Brake Diode				
Peak repetitive reverse voltage	V_{RRM}		1200	V
Continuous (direct) forward current	I_F	$T_j = T_{jmax}$ $T_s = 80\text{ °C}$	23	A
Repetitive peak forward current	I_{FRM}		50	A
Total power dissipation	P_{tot}	$T_j = T_{jmax}$ $T_s = 80\text{ °C}$	41	W
Maximum junction temperature	T_{jmax}		150	°C
Brake Sw. Protection Diode				
Peak repetitive reverse voltage	V_{RRM}		1200	V
Continuous (direct) forward current	I_F	$T_j = T_{jmax}$ $T_s = 80\text{ °C}$	4	A
Repetitive peak forward current	I_{FRM}		6	A
Total power dissipation	P_{tot}	$T_j = T_{jmax}$ $T_s = 80\text{ °C}$	19	W
Maximum junction temperature	T_{jmax}		150	°C



Vincotech

Maximum Ratings

$T_j = 25\text{ °C}$, unless otherwise specified

Parameter	Symbol	Condition	Value	Unit
-----------	--------	-----------	-------	------

Module Properties

Thermal Properties

Storage temperature	T_{stg}		-40...+125	°C
Operation temperature under switching condition	T_{top}		-40...(T _{jmax} - 25)	°C

Isolation Properties

Isolation voltage	V_{isol}	DC Test Voltage* $t_p = 2\text{ s}$	6000	V
		AC Voltage $t_p = 1\text{ min}$	2500	V
Creepage distance			min. 12,7	mm
Clearance			min. 12,7	mm
Comparative Tracking Index	CTI		> 200	

*100 % tested in production



Characteristic Values

Parameter	Symbol	Conditions					Value			Unit
		V_{GE} [V] V_{GS} [V]	V_{CE} [V] V_{DS} [V] V_F [V]	I_C [A] I_D [A] I_F [A]	T_j [°C]	Min	Typ	Max		

Rectifier Diode

Static

Forward voltage	V_F				80	25 125		1,18 1,15	1,23	V
Reverse leakage current	I_R			1600		25 150			50 1500	μA

Thermal

Thermal resistance junction to sink	$R_{th(j-s)}$	$\lambda_{paste} = 3,4$ W/mK (PSX)						0,79		K/W
-------------------------------------	---------------	---------------------------------------	--	--	--	--	--	------	--	-----

Brake Switch

Static

Gate-emitter threshold voltage	$V_{GE(th)}$	$V_{GE} = V_{CE}$			0,0015	25	5	5,8	6,5	V
Collector-emitter saturation voltage	V_{CEsat}		15		35	25 125	1,35	1,74 1,98	2,05	V
Collector-emitter cut-off current	I_{CES}		0	1200		25			250	μA
Gate-emitter leakage current	I_{GES}		30	0		25			600	nA
Internal gate resistance	r_g							6		Ω
Input capacitance	C_{ies}							2530		pF
Output capacitance	C_{oes}	$f = 1$ Mhz	0	25		25		132		
Reverse transfer capacitance	C_{res}							115		

Thermal

Thermal resistance junction to sink	$R_{th(j-s)}$	$\lambda_{paste} = 3,4$ W/mK (PSX)						0,97		K/W
-------------------------------------	---------------	---------------------------------------	--	--	--	--	--	------	--	-----

Dynamic

Turn-on delay time	$t_{d(on)}$					25 125		87 84		ns
Rise time	t_r	$R_{gon} = 32$ Ω $R_{goff} = 16$ Ω				25 125		20 22		
Turn-off delay time	$t_{d(off)}$					25 125		521 615		
Fall time	t_f		0 / 15	700	35	25 125		50 142		
Turn-on energy (per pulse)	E_{on}	$Q_{tFWD} = 2,8$ μC $Q_{tFWD} = 5$ μC				25 125		3,49 4,47		
Turn-off energy (per pulse)	E_{off}					25 125		2,68 4,32		mWs



Vincotech

Characteristic Values

Parameter	Symbol	Conditions					Value			Unit
		V_{GE} [V]	V_{CE} [V]	I_C [A]	T_j [°C]	Min	Typ	Max		

Brake Diode

Static

Parameter	Symbol	V_{GS} [V]	V_{DS} [V]	I_D [A]	I_F [A]	T_j [°C]	Min	Typ	Max	Unit
Forward voltage	V_F			25		25 125		1,79 1,80		V
Reverse leakage current	I_R		1200			25			27	µA

Thermal

Parameter	Symbol	λ_{paste} [W/mK] (PSX)	T_j [°C]	Min	Typ	Max	Unit
Thermal resistance junction to sink	$R_{th(j-s)}$	3,4			1,72		K/W

Dynamic

Parameter	Symbol	di/dt [A/µs]	I_D [A]	I_C [A]	T_j [°C]	Min	Typ	Max	Unit
Peak recovery current	I_{RRM}	2239 2068	0 / 15	700	35	25	37		A
Reverse recovery time	t_{rr}					125	45		ns
Recovered charge	Q_r					25	2,75		µC
Reverse recovered energy	E_{rec}					125	5,03		mWs
Peak rate of fall of recovery current	$(di_{rr}/dt)_{max}$					25	1,04		A/µs
						25	2619		
						125	1765		

Brake Sw. Protection Diode

Static

Parameter	Symbol	V_{GS} [V]	V_{DS} [V]	I_D [A]	I_F [A]	T_j [°C]	Min	Typ	Max	Unit
Forward voltage	V_F			3		25 125		1,66 1,59		V
Reverse leakage current	I_R		1200			25			250	µA

Thermal

Parameter	Symbol	λ_{paste} [W/mK] (PSX)	T_j [°C]	Min	Typ	Max	Unit
Thermal resistance junction to sink	$R_{th(j-s)}$	3,4			3,72		K/W



Rectifier Diode Characteristics

figure 1. Rectifier Diode

Typical forward characteristics

$$I_F = f(V_F)$$

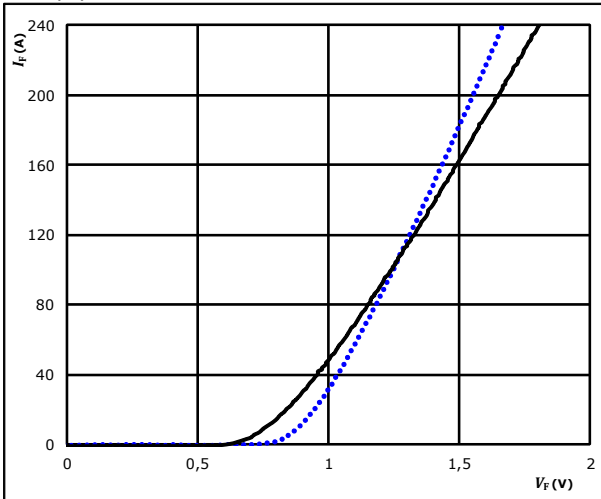

$t_p = 250 \mu s$ $T_j: 25 \text{ }^\circ\text{C}$ (dotted blue line) $125 \text{ }^\circ\text{C}$ (solid black line)

figure 2. Rectifier Diode

Transient thermal impedance as a function of pulse width

$$Z_{th(j-s)} = f(t_p)$$

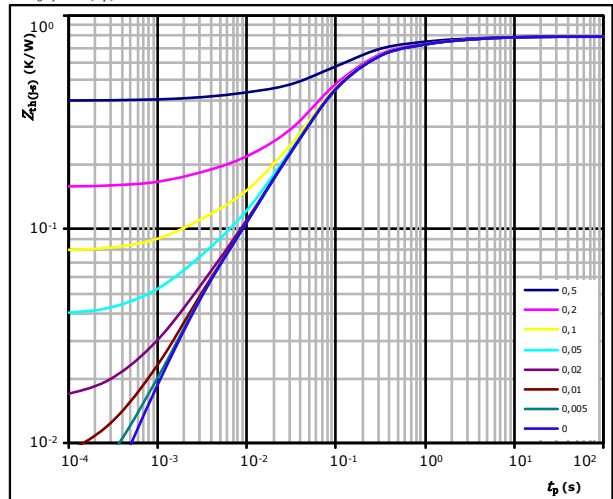

$D = t_p / T$
 $R_{th(j-s)} = 0,79 \text{ K/W}$

Diode thermal model values

R (K/W)	τ (s)
3,05E-02	5,20E+00
8,93E-02	9,97E-01
2,82E-01	1,58E-01
3,51E-01	5,43E-02
3,93E-02	2,64E-03



Brake Switch Characteristics

figure 1. IGBT

Typical output characteristics

$$I_C = f(V_{CE})$$

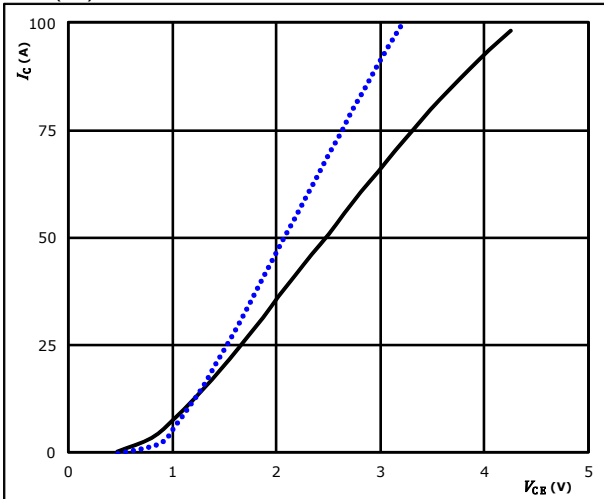

$t_p = 250 \mu\text{s}$ $T_j: 25 \text{ }^\circ\text{C}$ (dotted blue line)
 $V_{GE} = 15 \text{ V}$ $125 \text{ }^\circ\text{C}$ (solid black line)

figure 2. IGBT

Typical output characteristics

$$I_C = f(V_{CE})$$

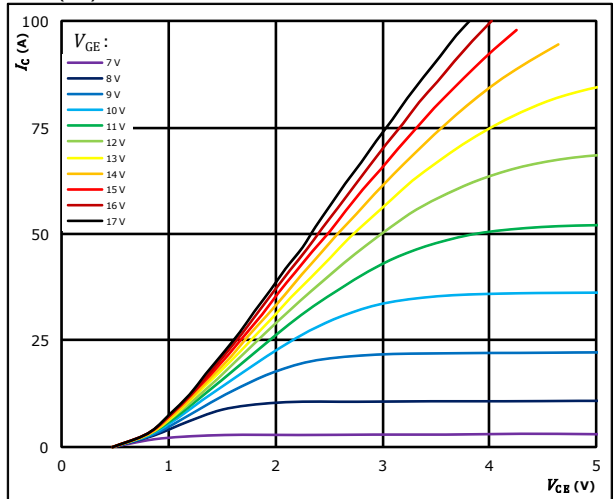

$t_p = 250 \mu\text{s}$
 $T_j = 125 \text{ }^\circ\text{C}$
 V_{GE} from 7 V to 17 V in steps of 1 V

figure 3. IGBT

Typical transfer characteristics

$$I_C = f(V_{GE})$$

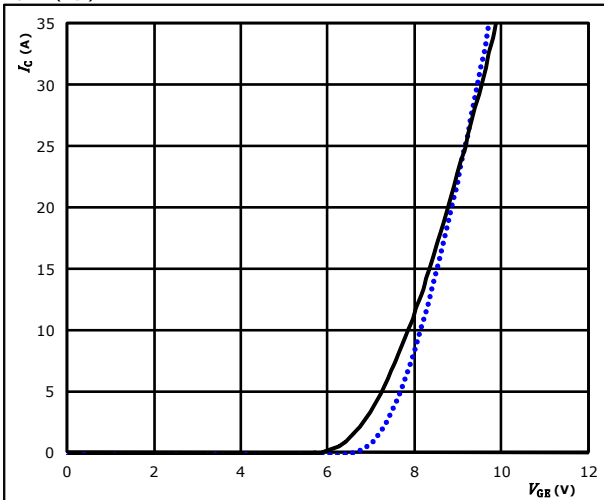

$t_p = 100 \mu\text{s}$ $T_j: 25 \text{ }^\circ\text{C}$ (dotted blue line)
 $V_{CE} = 10 \text{ V}$ $125 \text{ }^\circ\text{C}$ (solid black line)

figure 4. IGBT

Transient thermal impedance as function of pulse duration

$$Z_{th(j-s)} = f(t_p)$$

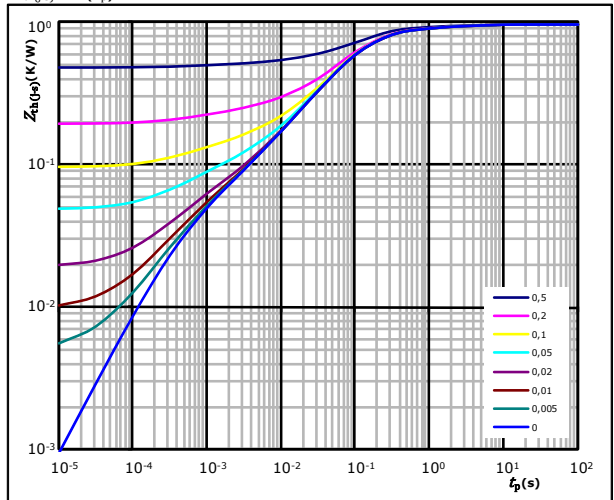

$D = t_p / T$
 $R_{th(j-s)} = 0,97 \text{ K/W}$

IGBT thermal model values

R (K/W)	τ (s)
6,59E-02	3,01E+00
1,61E-01	3,99E-01
6,07E-01	8,47E-02
7,79E-02	1,42E-02
3,57E-02	2,31E-03
2,73E-02	4,08E-04



Vincotech

Brake Switch Characteristics

figure 5. IGBT

Safe operating area

$$I_C = f(V_{CE})$$

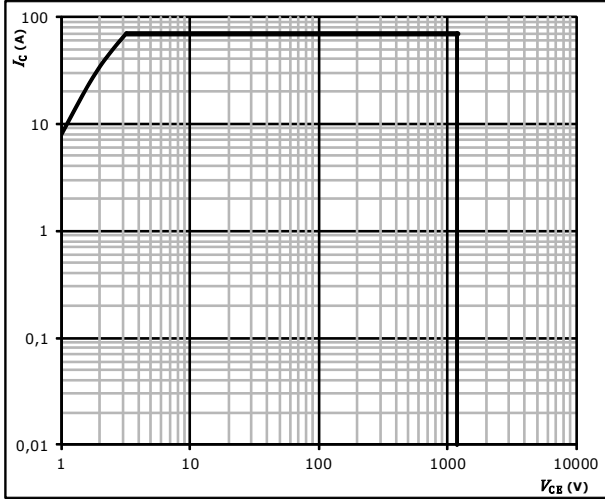

$D =$ single pulse
 $T_s =$ 80 °C
 $V_{GE} =$ ±15 V
 $T_j = T_{jmax}$



Brake Diode Characteristics

figure 1. FWD

Typical forward characteristics

$$I_F = f(V_F)$$

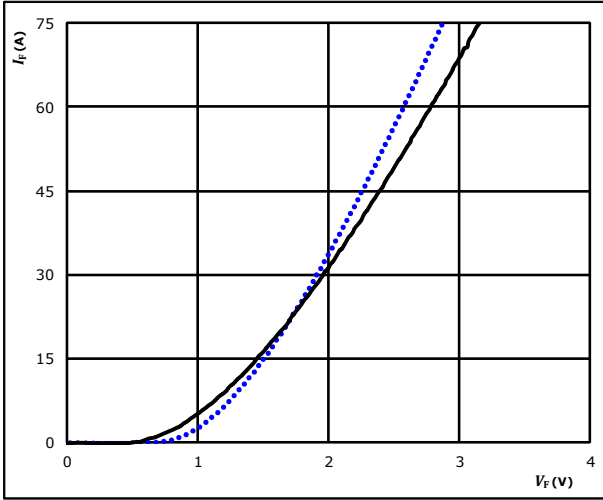

$t_p = 250 \mu s$ $T_j: 25 \text{ }^\circ\text{C}$ (blue dotted line) $125 \text{ }^\circ\text{C}$ (black solid line)

figure 2. FWD

Transient thermal impedance as a function of pulse width

$$Z_{th(j-s)} = f(t_p)$$

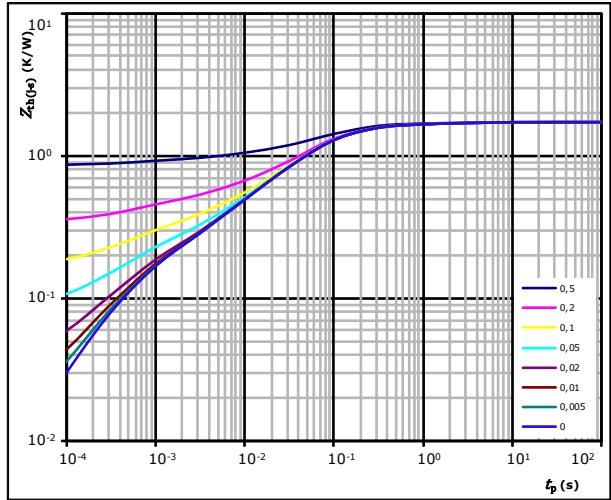

$D = t_p / T$
 $R_{th(j-s)} = 1,72 \text{ K/W}$

FWD thermal model values

R (K/W)	τ (s)
5,74E-02	3,42E+00
1,85E-01	4,11E-01
9,45E-01	7,07E-02
2,69E-01	1,95E-02
1,43E-01	3,59E-03
1,19E-01	4,63E-04



Vincotech

Brake Sw. Protection Diode Characteristics

figure 1. FWD

Typical forward characteristics

$$I_F = f(V_F)$$

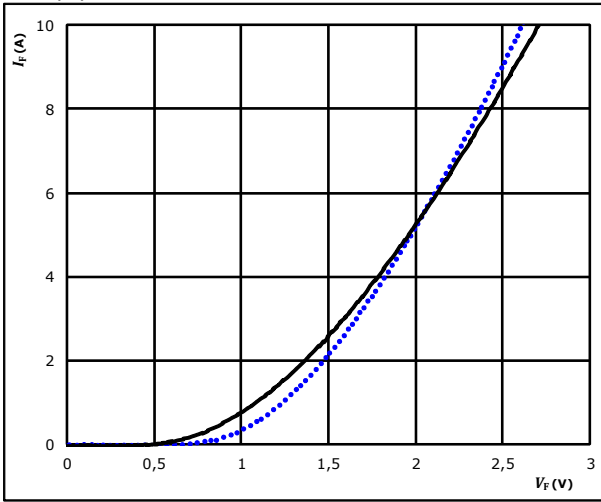

$t_p = 250 \mu s$ $T_j: 25 \text{ }^\circ\text{C}$ (dotted blue line)
 $125 \text{ }^\circ\text{C}$ (solid black line)

figure 2. FWD

Transient thermal impedance as a function of pulse width

$$Z_{th(j-s)} = f(t_p)$$

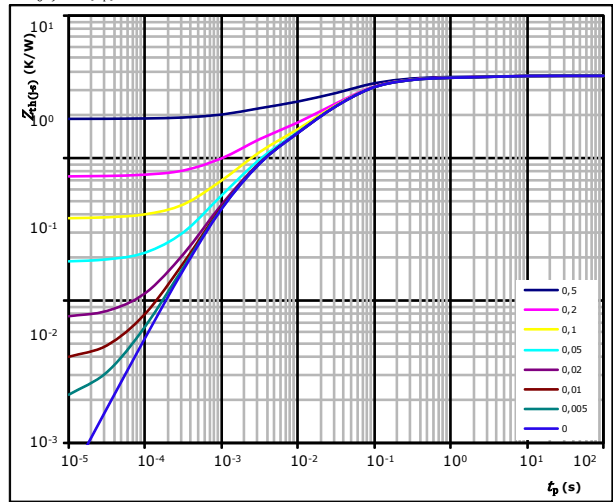

$D = t_p / T$
 $R_{th(j-s)} = 3,72 \text{ K/W}$

FWD thermal model values

R (K/W)	τ (s)
1,58E-01	3,25E+00
5,74E-01	1,68E-01
1,74E+00	4,01E-02
5,91E-01	8,37E-03
6,54E-01	1,47E-03



Brake Switching Characteristics

figure 1. IGBT

Typical switching energy losses as a function of collector current

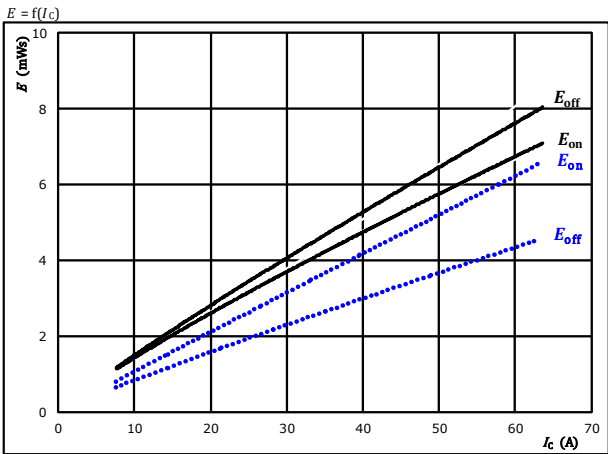

With an inductive load at T_j : 25 °C (dotted blue line), 125 °C (solid black line)

$V_{CE} = 700$ V
 $V_{GE} = 0 / 15$ V
 $R_{gon} = 32$ Ω
 $R_{goff} = 16$ Ω

figure 2. IGBT

Typical switching energy losses as a function of gate resistor

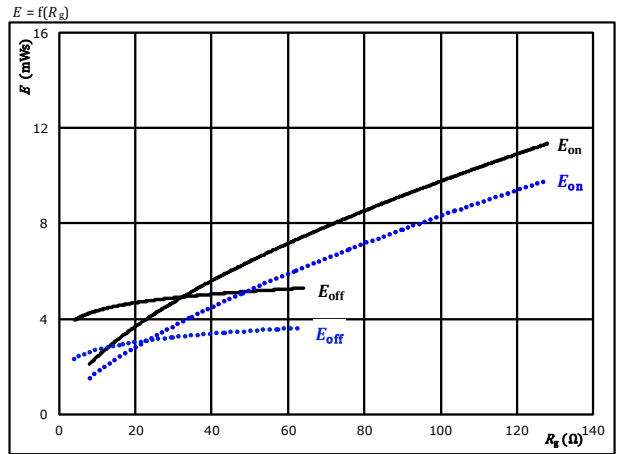

With an inductive load at T_j : 25 °C (dotted blue line), 125 °C (solid black line)

$V_{CE} = 700$ V
 $V_{GE} = 0 / 15$ V
 $I_C = 35$ A

figure 3. FWD

Typical reverse recovered energy loss as a function of collector current

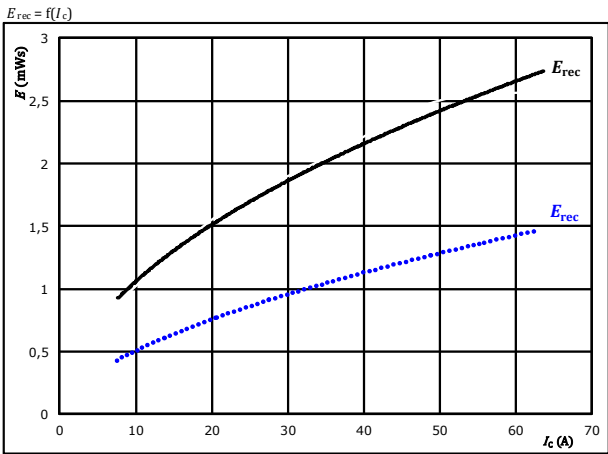

With an inductive load at T_j : 25 °C (dotted blue line), 125 °C (solid black line)

$V_{CE} = 700$ V
 $V_{GE} = 0 / 15$ V
 $R_{gon} = 32$ Ω

figure 4. FWD

Typical reverse recovered energy loss as a function of gate resistor

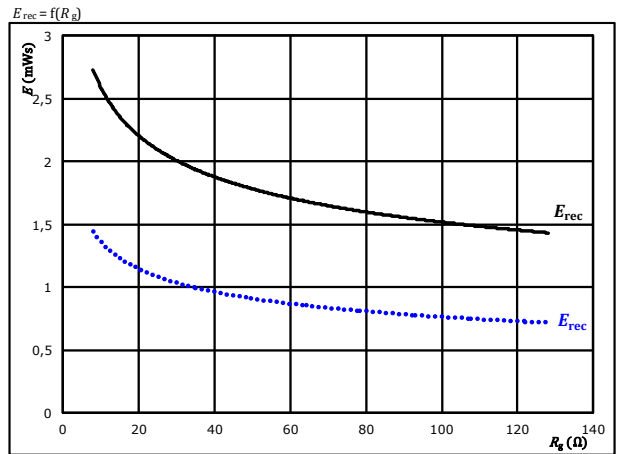

With an inductive load at T_j : 25 °C (dotted blue line), 125 °C (solid black line)

$V_{CE} = 700$ V
 $V_{GE} = 0 / 15$ V
 $I_C = 35$ A



Brake Switching Characteristics

figure 5. IGBT

Typical switching times as a function of collector current

$$t = f(I_C)$$

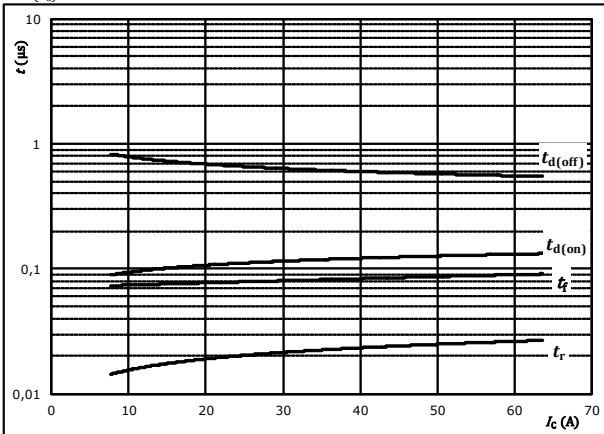

With an inductive load at

$T_j =$	0	°C
$V_{CE} =$	700	V
$V_{GE} =$	0 / 15	V
$R_{gon} =$	32	Ω
$R_{goff} =$	16	Ω

figure 6. IGBT

Typical switching times as a function of gate resistor

$$t = f(R_g)$$

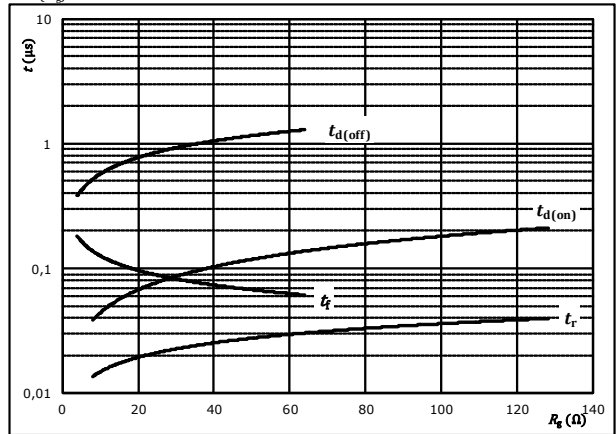

With an inductive load at

$T_j =$	0	°C
$V_{CE} =$	700	V
$V_{GE} =$	0 / 15	V
$I_C =$	35	A

figure 7. FWD

Typical reverse recovery time as a function of collector current

$$t_{rr} = f(I_C)$$

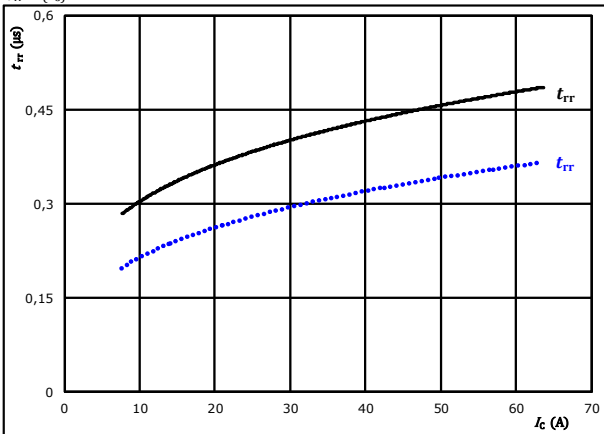

With an inductive load at

$V_{CE} =$	700	V
$V_{GE} =$	0 / 15	V
$R_{gon} =$	32	Ω

$T_j:$ 25 °C (dotted blue)
125 °C (solid black)

figure 8. FWD

Typical reverse recovery time as a function of IGBT turn on gate resistor

$$t_{rr} = f(R_{gon})$$

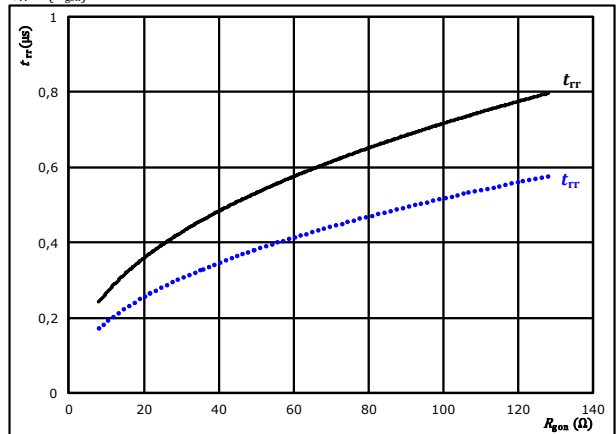

With an inductive load at

$V_{CE} =$	700	V
$V_{GE} =$	0 / 15	V
$I_C =$	35	A

$T_j:$ 25 °C (dotted blue)
125 °C (solid black)



Brake Switching Characteristics

figure 9. FWD

Typical recovered charge as a function of collector current

$$Q_r = f(I_c)$$

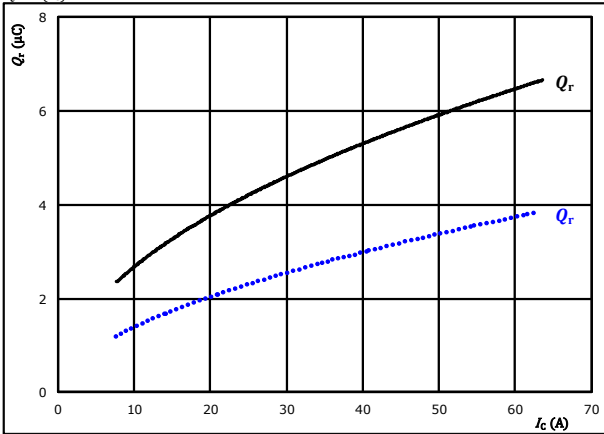

With an inductive load at T_j : 25 °C (dotted line), 125 °C (solid line)
 $V_{CE} = 700$ V
 $V_{GE} = 0 / 15$ V
 $R_{gdn} = 32$ Ω

figure 10. FWD

Typical recovered charge as a function of IGBT turn on gate resistor

$$Q_r = f(R_{gdn})$$

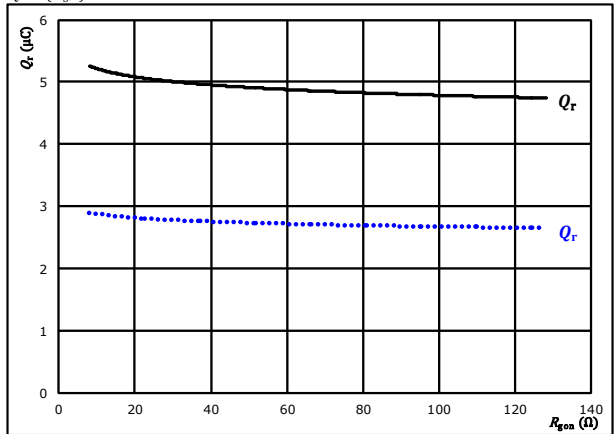

With an inductive load at T_j : 25 °C (dotted line), 125 °C (solid line)
 $V_{CE} = 700$ V
 $V_{GE} = 0 / 15$ V
 $I_c = 35$ A

figure 11. FWD

Typical peak reverse recovery current as a function of collector current

$$I_{RM} = f(I_c)$$

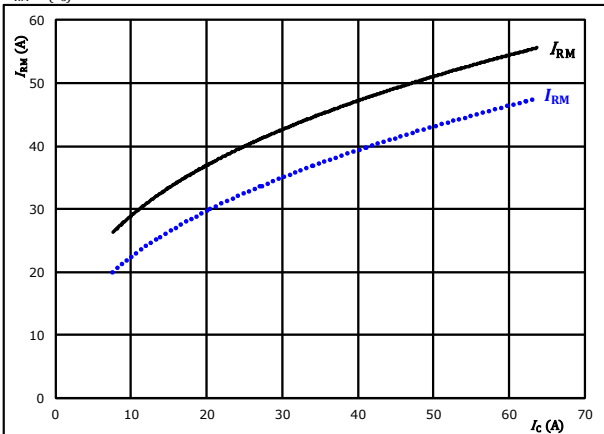

With an inductive load at T_j : 25 °C (dotted line), 125 °C (solid line)
 $V_{CE} = 700$ V
 $V_{GE} = 0 / 15$ V
 $R_{gdn} = 32$ Ω

figure 12. FWD

Typical peak reverse recovery current as a function of IGBT turn on gate resistor

$$I_{RM} = f(R_{gdn})$$

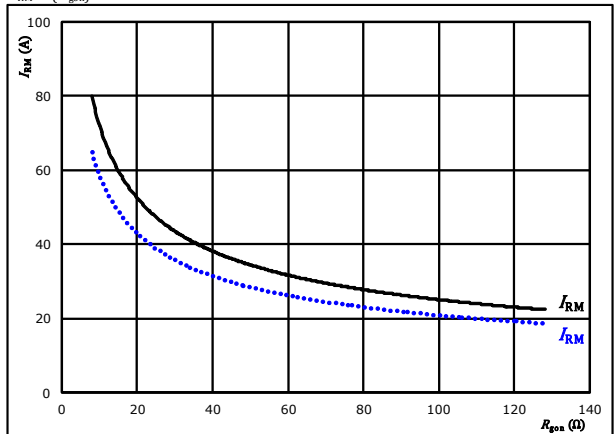

With an inductive load at T_j : 25 °C (dotted line), 125 °C (solid line)
 $V_{CE} = 700$ V
 $V_{GE} = 0 / 15$ V
 $I_c = 35$ A



Brake Switching Characteristics

figure 13. FWD

Typical rate of fall of forward and reverse recovery current as a function of collector current
 $di_F/dt, di_{rr}/dt = f(I_C)$

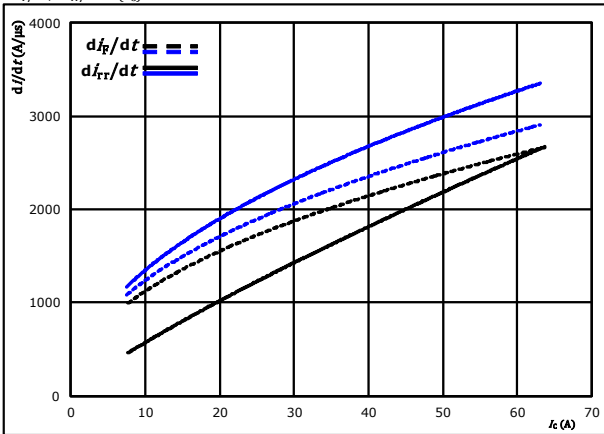

With an inductive load at
 $V_{CE} = 700$ V
 $V_{GE} = 0 / 15$ V
 $R_{g0n} = 32$ Ω
 $T_j = 25$ °C
 125 °C

figure 14. FWD

Typical rate of fall of forward and reverse recovery current as a function of IGBT turn on gate resistor
 $di_F/dt, di_{rr}/dt = f(R_{g0n})$

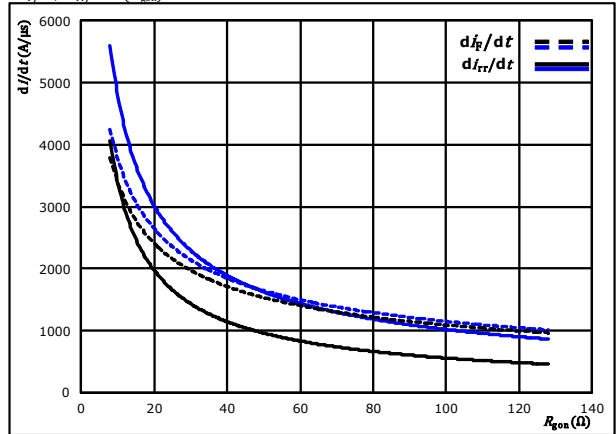

With an inductive load at
 $V_{CE} = 700$ V
 $V_{GE} = 0 / 15$ V
 $I_C = 35$ A
 $T_j = 25$ °C
 125 °C

figure 15. IGBT

Reverse bias safe operating area
 $I_C = f(V_{CE})$

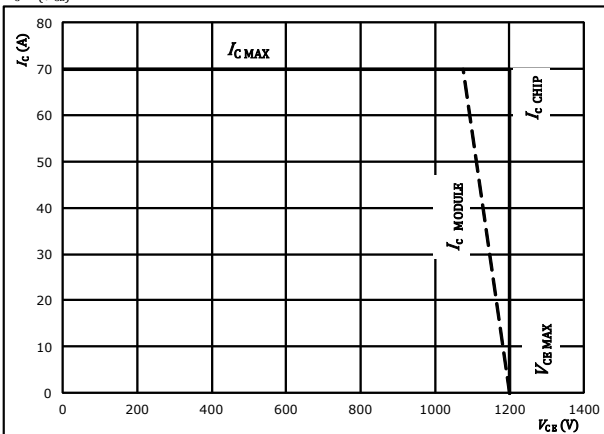

At
 $T_j = 125$ °C
 $R_{g0n} = 32$ Ω
 $R_{g0ff} = 16$ Ω



Brake Switching Definitions

General conditions

T_j	=	125 °C
$R_{g\text{on}}$	=	32 Ω
$R_{g\text{off}}$	=	16 Ω

figure 1. IGBT

Turn-off Switching Waveforms & definition of t_{doff} , t_{Eoff} (t_{Eoff} = integrating time for E_{off})

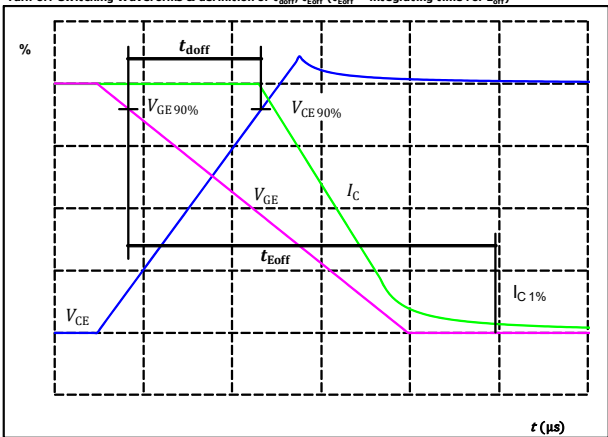

$V_{CE}(0\%) =$	0	V
$V_{GE}(100\%) =$	15	V
$V_C(100\%) =$	700	V
$I_C(100\%) =$	35	A
$t_{\text{doff}} =$	615	ns

figure 2. IGBT

Turn-on Switching Waveforms & definition of t_{don} , t_{Eon} (t_{Eon} = integrating time for E_{on})

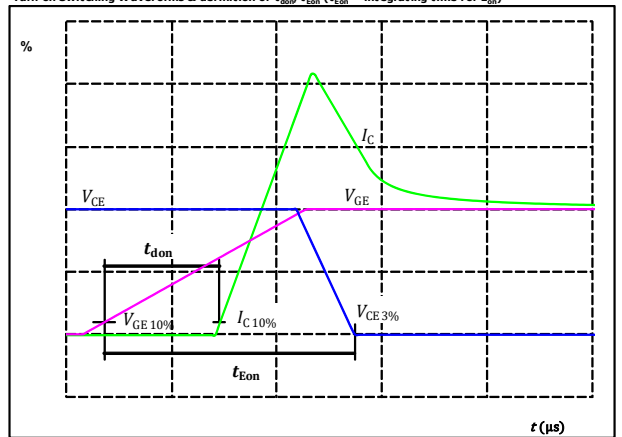

$V_{CE}(0\%) =$	0	V
$V_{GE}(100\%) =$	15	V
$V_C(100\%) =$	700	V
$I_C(100\%) =$	35	A
$t_{\text{don}} =$	84	ns

figure 3. IGBT

Turn-off Switching Waveforms & definition of t_r

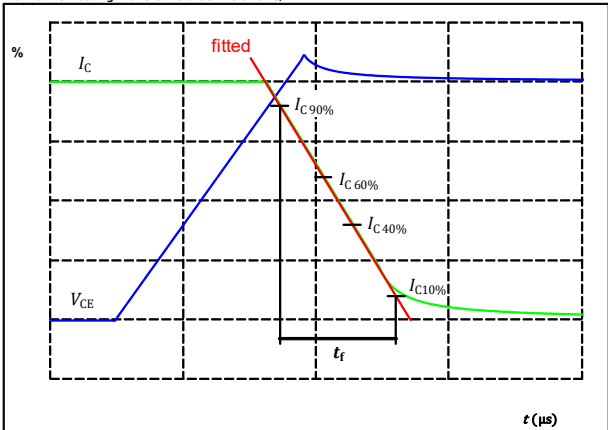

$V_C(100\%) =$	700	V
$I_C(100\%) =$	35	A
$t_r =$	142	ns

figure 4. IGBT

Turn-on Switching Waveforms & definition of t_r

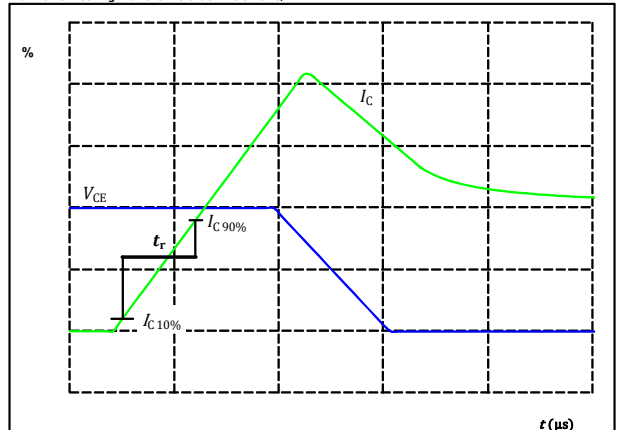

$V_C(100\%) =$	700	V
$I_C(100\%) =$	35	A
$t_r =$	22	ns



Brake Switching Characteristics

figure 5. FWD
Turn-off Switching Waveforms & definition of t_{rr}

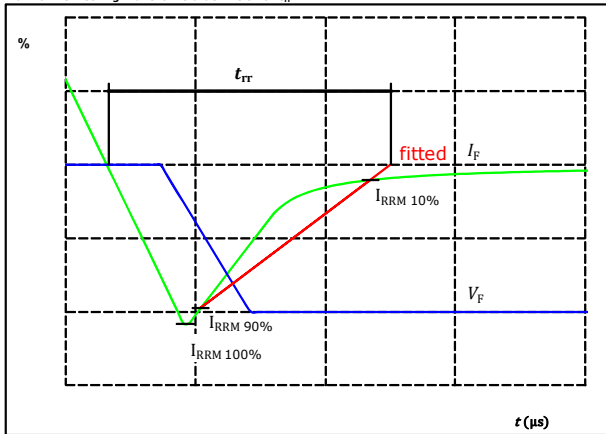

$V_F(100\%) =$	700	V
$I_F(100\%) =$	35	A
$I_{RRM}(100\%) =$	45	A
$t_{rr} =$	420	ns

figure 6. FWD
Turn-on Switching Waveforms & definition of t_{qr} ($t_{qr} =$ integrating time for Q_r)

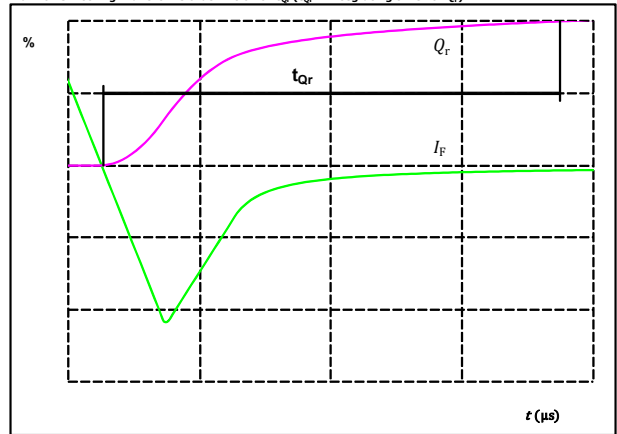

$I_F(100\%) =$	35	A
$Q_r(100\%) =$	5,03	μC



Vincotech

Ordering Code & Marking							
Version				Ordering Code			
without thermal paste 17 mm housing with solder pins				V23990-P640-G-PM			
with thermal paste 17 mm housing with solder pins				V23990-P640-G-/3-/PM			
Text	VIN	Date code	Name&Ver	UL	Lot	Serial	
	VIN	WWYY	NNNNNNNVV	UL	LLLLL	SSSS	
Datamatrix	Type&Ver	Lot number	Serial	Date code			
	TTTTTTTVV	LLLLL	SSSS	WWYY			

Pin table			
Pin	X	Y	Function
1	33,5	0	BrE
2	30,7	0	BrG
3	26,4	0	BrE
4	Not assembled		
5	21,4	0	DC-
6	18,9	0	DC-
7	11,9	0	NTC1
8	Not assembled		
9	4,7	0	NTC2
10	Not assembled		
11	0	2,5	DC+
12	0	5	DC+
13	0	7,5	DC+
14	0	22,5	L1
15	2,5	22,5	L1
16	5	22,5	L1
17	12	22,5	L2
18	14,5	22,5	L2
19	17	22,5	L2
20	24	22,5	L3
21	26,5	22,5	L3
22	29	22,5	L3
23	33,5	17,1	BrC
24	33,5	14,6	BrC
25	33,5	7	Br+

Tolerance of pinpositions: ±0.5mm at the end of pins
Dimension of coordinate axis is only offset without tolerance



Vincotech

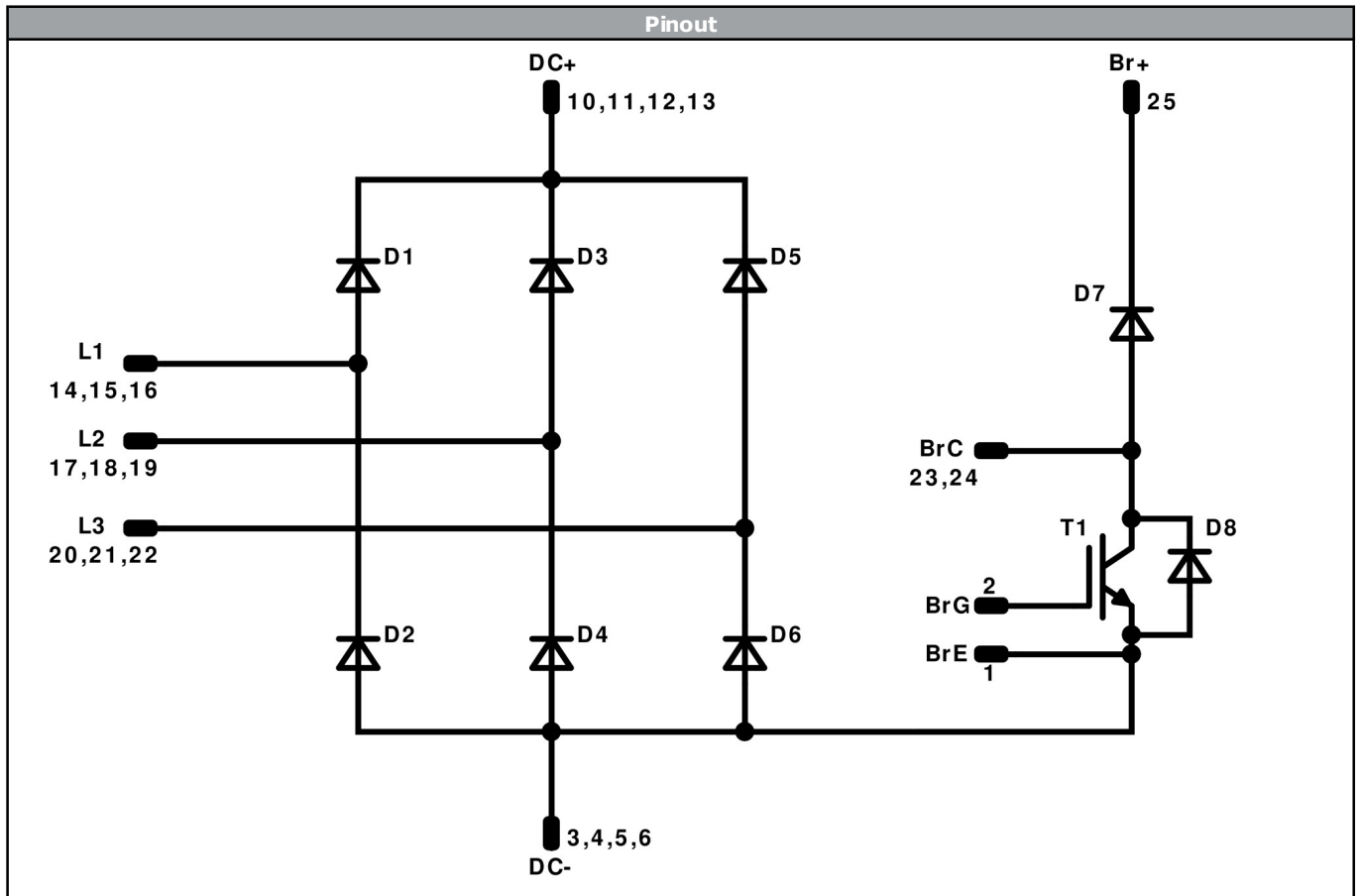

Identification					
ID	Component	Voltage	Current	Function	Comment
D1, D2, D3, D4, D5, D6	Rectifier	1600 V	80 A	Rectifier Diode	
T1	IGBT	1200 V	35 A	Brake Switch	
D7	FWD	1200 V	25 A	Brake Diode	
D8	FWD	1200 V	3 A	Brake Sw. Protection Diode	



Vincotech

Packaging instruction			
Standard packaging quantity (SPQ) 135	>SPQ	Standard	<SPQ Sample

Handling instruction
Handling instructions for <i>flow 0</i> packages see vincotech.com website.

Package data
Package data for <i>flow 0</i> packages see vincotech.com website.

UL recognition and file number
This device is certified according to UL 1557 standard, UL file number E192116. For more information see vincotech.com website. 

Document No.:	Date:	Modification:	Pages
V23990-P640-G-D2-14	02 Apr. 2019	Correction of I_c/I_f values	2

DISCLAIMER

The information, specifications, procedures, methods and recommendations herein (together "information") are presented by Vincotech to reader in good faith, are believed to be accurate and reliable, but may well be incomplete and/or not applicable to all conditions or situations that may exist or occur. Vincotech reserves the right to make any changes without further notice to any products to improve reliability, function or design. No representation, guarantee or warranty is made to reader as to the accuracy, reliability or completeness of said information or that the application or use of any of the same will avoid hazards, accidents, losses, damages or injury of any kind to persons or property or that the same will not infringe third parties rights or give desired results. It is reader's sole responsibility to test and determine the suitability of the information and the product for reader's intended use.

LIFE SUPPORT POLICY

Vincotech products are not authorised for use as critical components in life support devices or systems without the express written approval of Vincotech.

As used herein:

1. Life support devices or systems are devices or systems which, (a) are intended for surgical implant into the body, or (b) support or sustain life, or (c) whose failure to perform when properly used in accordance with instructions for use provided in labelling can be reasonably expected to result in significant injury to the user.
2. A critical component is any component of a life support device or system whose failure to perform can be reasonably expected to cause the failure of the life support device or system, or to affect its safety or effectiveness.