

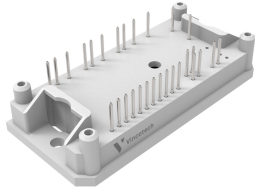

flowPIM 1		1200 V / 35 A	
Features		flow 1 17 mm housing	
<ul style="list-style-type: none">• Three-phase rectifier, optional BRC, Inverter, NTC• Very compact housing, easy to route• IGBT4 / EmCon4 technology for low saturation losses and improved EMC behavior			
Target applications		Schematic	
<ul style="list-style-type: none">• Industrial drives• Embedded drives			
Types			
<ul style="list-style-type: none">• V23990-P580-C41-PM			

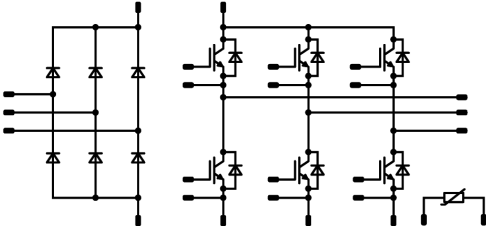

Vincotech

Maximum Ratings

$T_j = 25\text{ °C}$, unless otherwise specified

Parameter	Symbol	Conditions	Value	Unit
Inverter Switch				
Collector-emitter voltage	V_{CES}		1200	V
Collector current (DC current)	I_C	$T_j = T_{jmax}$ $T_s = 80\text{ °C}$	41	A
Repetitive peak collector current	I_{CRM}	t_p limited by T_{jmax}	105	A
Total power dissipation	P_{tot}	$T_j = T_{jmax}$ $T_s = 80\text{ °C}$	114	W
Gate-emitter voltage	V_{GES}		± 20	V
Short circuit ratings	t_{SC}	$V_{GE} = 15\text{ V}$, $V_{CC} = 800\text{ V}$ $T_j = 150\text{ °C}$	10	μs
Maximum junction temperature	T_{jmax}		175	$^{\circ}\text{C}$

Inverter Diode

Peak repetitive reverse voltage	V_{RRM}		1200	V
Forward current (DC current)	I_F	$T_j = T_{jmax}$ $T_s = 80\text{ °C}$	41	A
Repetitive peak forward current	I_{FRM}	t_p limited by T_{jmax}	70	A
Total power dissipation	P_{tot}	$T_j = T_{jmax}$ $T_s = 80\text{ °C}$	80	W
Maximum junction temperature	T_{jmax}		175	$^{\circ}\text{C}$

Brake Switch

Collector-emitter voltage	V_{CES}		1200	V
Collector current (DC current)	I_C	$T_j = T_{jmax}$ $T_s = 80\text{ °C}$	33	A
Repetitive peak collector current	I_{CRM}	t_p limited by T_{jmax}	75	A
Total power dissipation	P_{tot}	$T_j = T_{jmax}$ $T_s = 80\text{ °C}$	94	W
Gate-emitter voltage	V_{GES}		± 20	V
Short circuit ratings	t_{SC}	$V_{GE} = 15\text{ V}$, $V_{CC} = 800\text{ V}$ $T_j = 150\text{ °C}$	10	μs
Maximum junction temperature	T_{jmax}		175	$^{\circ}\text{C}$



Vincotech

Maximum Ratings

$T_j = 25\text{ °C}$, unless otherwise specified

Parameter	Symbol	Conditions	Value	Unit
Brake Diode				
Peak repetitive reverse voltage	V_{RRM}		1200	V
Forward current (DC current)	I_F	$T_j = T_{jmax}$ $T_s = 80\text{ °C}$	19	A
Repetitive peak forward current	I_{FRM}	t_p limited by T_{jmax}	20	A
Total power dissipation	P_{tot}	$T_j = T_{jmax}$ $T_s = 80\text{ °C}$	46	W
Maximum junction temperature	T_{jmax}		175	°C

Rectifier Diode

Peak repetitive reverse voltage	V_{RRM}		1600	V
Forward current (DC current)	I_F	$T_j = T_{jmax}$ $T_s = 80\text{ °C}$	46	A
Surge (non-repetitive) forward current	I_{FSM}	Single Half Sine Wave, $t_p = 10\text{ ms}$ $T_j = 150\text{ °C}$	270	A
Surge current capability	I^2t		370	A ² s
Total power dissipation	P_{tot}	$T_j = T_{jmax}$ $T_s = 80\text{ °C}$	56	W
Maximum junction temperature	T_{jmax}		150	°C

Module Properties

Thermal Properties

Storage temperature	T_{stg}		-40...+125	°C
Operation temperature under switching condition	T_{jop}		-40...+($T_{jmax} - 25$)	°C

Isolation Properties

Isolation voltage	V_{isol}	DC Test Voltage* $t_p = 2\text{ s}$	6000	V
Isolation voltage	V_{isol}	AC Voltage $t_p = 1\text{ min}$	2500	V
Creepage distance			>12,7	mm
Clearance			>12,7	mm
Comparative Tracking Index	CTI		≥ 600	

*100 % tested in production



Characteristic Values

Parameter	Symbol	Conditions					Values			Unit
		V_{GS} [V]	V_{GE} [V]	V_{DS} [V]	I_D [A]	T_j [°C]	Min	Typ	Max	

Inverter Switch

Static

Gate-emitter threshold voltage	$V_{GE(th)}$	$V_{CE} = V_{GE}$			0,0012	25	5,3	5,8	6,3	V
Collector-emitter saturation voltage	$V_{CE(sat)}$		15		35	25 150	1,58	1,95 2,4	2,07 ⁽¹⁾	V
Collector-emitter cut-off current	I_{CES}		0	1200		25			5	μA
Gate-emitter leakage current	I_{GES}		20	0		25			120	nA
Internal gate resistance	r_g							None		Ω
Input capacitance	C_{ies}	$f = 1 \text{ Mhz}$	0	25		25		2000		pF
Reverse transfer capacitance	C_{res}									
Gate charge	Q_g		15		0	25		270		nC

Thermal

Thermal resistance junction to sink ⁽²⁾	$R_{th(j-s)}$	$\lambda_{paste} = 3,4 \text{ W/mK}$ (PSX)						0,83		K/W
--	---------------	---	--	--	--	--	--	------	--	-----

Dynamic

Turn-on delay time	$t_{d(on)}$	$R_{gon} = 16 \Omega$ $R_{goff} = 16 \Omega$	±15	600	35	25		92		ns
Rise time	t_r					150		91,6		ns
Turn-off delay time	$t_{d(off)}$					25		18		ns
Fall time	t_f					150		23,4		ns
Turn-on energy (per pulse)	E_{on}					25		212,6		mWs
Turn-off energy (per pulse)	E_{off}					150		273,8		mWs
						25		75,33		mWs
		150		104,91		mWs				
		25		1,62		mWs				
		150		2,49		mWs				
		25		1,81		mWs				
		150		2,82		mWs				



Vincotech

Characteristic Values

Parameter	Symbol	Conditions					Values			Unit
		V_{GE} [V] V_{GS} [V]	V_{CE} [V] V_{DS} [V] V_F [V]	I_C [A] I_D [A] I_F [A]	T_j [°C]	Min	Typ	Max		

Inverter Diode

Static

Forward voltage	V_F				35	25 150	1,35	1,83 1,8	2,05 ⁽¹⁾	V
Reverse leakage current	I_R	$V_i = 1200$ V				25			7,7	μA

Thermal

Thermal resistance junction to sink ⁽²⁾	$R_{th(j-s)}$	$\lambda_{paste} = 3,4$ W/mK (PSX)						1,19		K/W
--	---------------	---------------------------------------	--	--	--	--	--	------	--	-----

Dynamic

Peak recovery current	I_{RRM}	$di/dt=2744$ A/μs $di/dt=2239$ A/μs	±15	600	35	25		68,91		A
						150		78,7		
Reverse recovery time	t_{rr}					25		150,18		
						150		277,1		
Recovered charge	Q_r					25		3,93		
						150		7,47		
Reverse recovered energy	E_{rec}					25		1,69		mWs
						150		3,31		
Peak rate of fall of recovery current	$(di_{rr}/dt)_{max}$					25		4100		A/μs
						150		2080		



Characteristic Values

Parameter	Symbol	Conditions					Values			Unit
		V_{GS} [V]	V_{GE} [V]	V_{DS} [V]	I_D [A]	T_j [°C]	Min	Typ	Max	

Brake Switch

Static

Gate-emitter threshold voltage	$V_{GE(th)}$	$V_{CE} = V_{GE}$			0,00085	25	5,3	5,8	6,3	V
Collector-emitter saturation voltage	$V_{CE(sat)}$		15		25	25 150	1,58	1,87 2,31	2,07 ⁽¹⁾	V
Collector-emitter cut-off current	I_{CES}		0	1200		25			2,4	μA
Gate-emitter leakage current	I_{GES}		20	0		25			120	nA
Internal gate resistance	r_g							None		Ω
Input capacitance	C_{ies}	$f = 1 \text{ Mhz}$	0	25		25		1450		pF
Reverse transfer capacitance	C_{res}									
Gate charge	Q_g		15		0	25		200		nC

Thermal

Thermal resistance junction to sink ⁽²⁾	$R_{th(j-s)}$	$\lambda_{paste} = 3,4 \text{ W/mK}$ (PSX)						1,01		K/W
--	---------------	---	--	--	--	--	--	------	--	-----

Dynamic

Turn-on delay time	$t_{d(on)}$	$R_{gon} = 32 \Omega$ $R_{goff} = 32 \Omega$	±15	600	25	25		126,6		ns
Rise time	t_r					150		128,8		ns
						25		36		ns
Turn-off delay time	$t_{d(off)}$					150		232		ns
						25		275,6		ns
Fall time	t_f					25		73,75		ns
		150		111,69		ns				
Turn-on energy (per pulse)	E_{on}	$Q_{rFWD} = 1,55 \mu\text{C}$			25		1,81		mWs	
		$Q_{rFWD} = 3,03 \mu\text{C}$			150		2,42		mWs	
Turn-off energy (per pulse)	E_{off}				25		1,37		mWs	
					150		2,19		mWs	



Characteristic Values

Parameter	Symbol	Conditions					Values			Unit
		V_{GE} [V] V_{GS} [V]	V_{CE} [V] V_{DS} [V] V_F [V]	I_C [A] I_D [A] I_F [A]	T_j [°C]	Min	Typ	Max		

Brake Diode

Static

Forward voltage	V_F				10	25 150	1,35	1,85 1,77	2,05 ⁽¹⁾	V
Reverse leakage current	I_R	$V_r = 1200$ V				25			2,7	μA

Thermal

Thermal resistance junction to sink ⁽²⁾	$R_{th(j-s)}$	$\lambda_{paste} = 3,4$ W/mK (PSX)						2,07		K/W
--	---------------	------------------------------------	--	--	--	--	--	------	--	-----

Dynamic

Peak recovery current	I_{RRM}	$di/dt=570$ A/μs $di/dt=504$ A/μs	±15	600	25	25		10,17		A
Reverse recovery time	t_{rr}					150		12,29		ns
						25		396,24		
Recovered charge	Q_r					150		624,1		μC
						25		1,55		
Reverse recovered energy	E_{rec}	150		3,03		mWs				
		25		0,631						
Peak rate of fall of recovery current	$(di_r/dt)_{max}$	25		35,97		A/μs				
		150		31,78						

Rectifier Diode

Static

Forward voltage	V_F				13	25 125		0,988 0,899	1,21 ⁽¹⁾ 1,1 ⁽¹⁾	V
Reverse leakage current	I_R	$V_r = 1600$ V				25			50	μA

Thermal

Thermal resistance junction to sink ⁽²⁾	$R_{th(j-s)}$	$\lambda_{paste} = 3,4$ W/mK (PSX)						1,25		K/W
--	---------------	------------------------------------	--	--	--	--	--	------	--	-----



Characteristic Values

Parameter	Symbol	Conditions					Values			Unit
		V_{GS} [V]	V_{GE} [V]	V_{DS} [V]	V_{CE} [V]	T_j [°C]	Min	Typ	Max	

Thermistor

Static

Rated resistance	R					25		22		kΩ
Deviation of R_{100}	$A_{R/R}$	$R_{100} = 1486 \Omega$				100	-12		14	%
Power dissipation	P							200		mW
Power dissipation constant	d					25		2		mW/K
B-value	$B_{(25/50)}$	Tol. $\pm 3 \%$						3950		K
B-value	$B_{(25/100)}$	Tol. $\pm 3 \%$						3998		K
Vincotech Thermistor Reference									B	

⁽¹⁾ Value at chip level

⁽²⁾ Only valid with pre-applied Vincotech thermal interface material.



Inverter Switch Characteristics

figure 1. IGBT

Typical output characteristics

$$I_C = f(V_{CE})$$

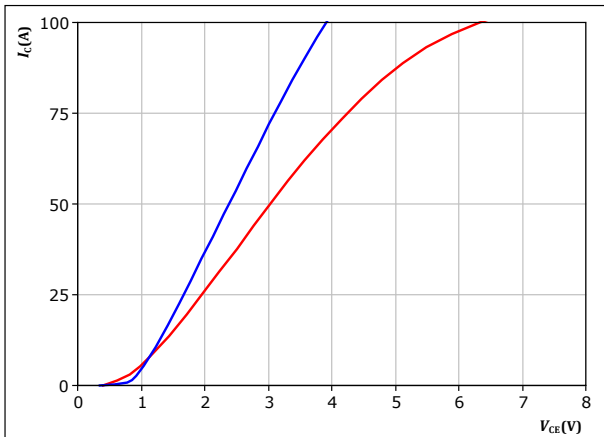

$t_p = 250 \mu s$
 $V_{GE} = 15 V$
 $T_j:$ — 25 °C
— 150 °C

figure 2. IGBT

Typical output characteristics

$$I_C = f(V_{CE})$$

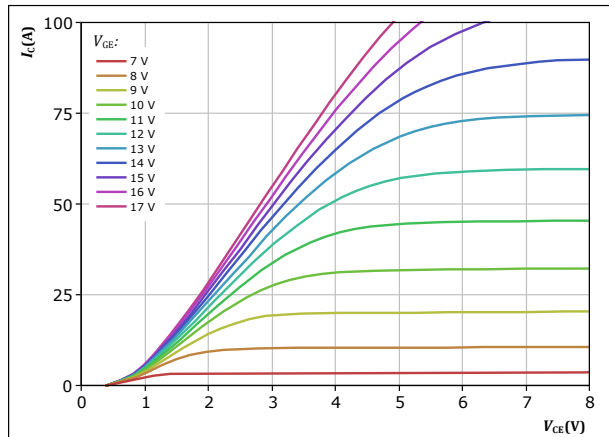

$t_p = 250 \mu s$
 $T_j = 150 \text{ } ^\circ C$
 V_{GE} from 7 V to 17 V in steps of 1 V

figure 3. IGBT

Typical transfer characteristics

$$I_C = f(V_{GE})$$

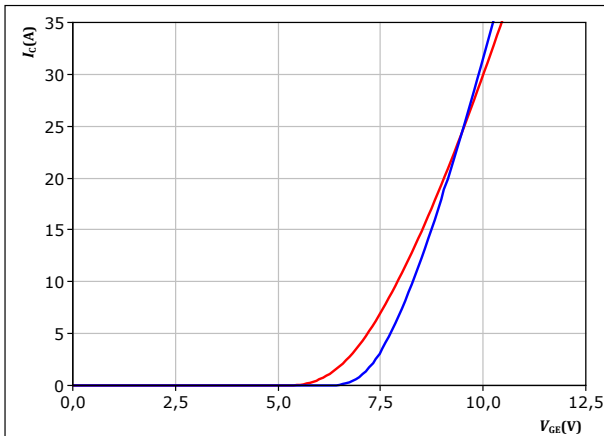

$t_p = 250 \mu s$
 $V_{CE} = 10 V$
 $T_j:$ — 25 °C
— 150 °C

figure 4. IGBT

Transient thermal impedance as a function of pulse width

$$Z_{th(j-s)} = f(t_p)$$

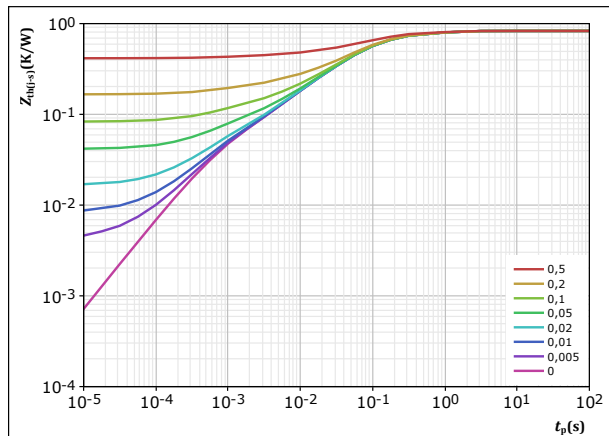

$D = t_p / T$
 $R_{th(j-s)} = 0,83 \text{ K/W}$
IGBT thermal model values

R (K/W)	τ (s)
1,05E-01	8,11E-01
3,41E-01	1,17E-01
2,63E-01	4,29E-02
8,23E-02	7,80E-03
3,86E-02	7,37E-04



Inverter Switch Characteristics

figure 5. IGBT

Safe operating area

$$I_C = f(V_{CE})$$

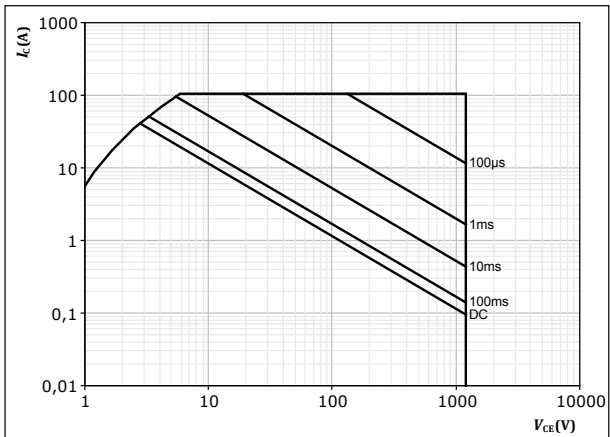

$D =$ single pulse

$T_s = 80 \text{ } ^\circ\text{C}$

$V_{GE} = 15 \text{ V}$

$T_j = T_{jmax}$



Inverter Diode Characteristics

figure 6. FWD

Typical forward characteristics

$$I_F = f(V_F)$$

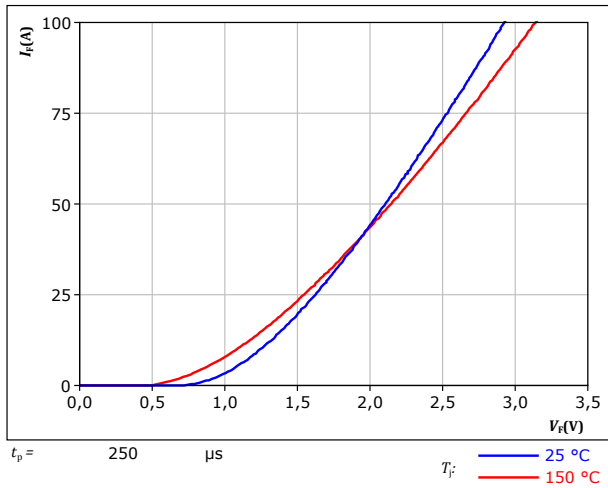
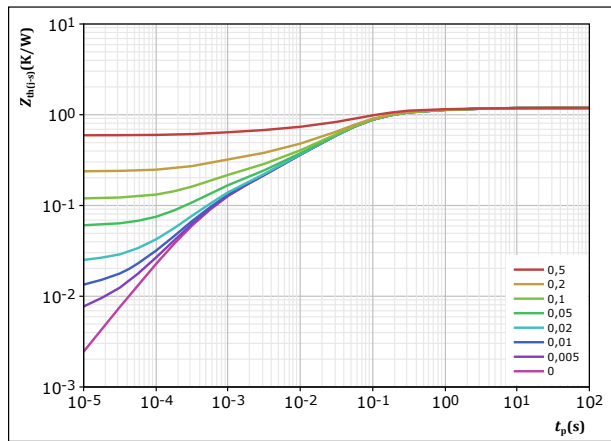

figure 7. FWD

Transient thermal impedance as a function of pulse width

$$Z_{th(j-s)} = f(t_p)$$



$D = t_p / T$

$R_{th(j-s)} = 1,187 \text{ K/W}$

FWD thermal model values

$R \text{ (K/W)}$	$\tau \text{ (s)}$
6,30E-02	2,93E+00
1,30E-01	4,06E-01
5,50E-01	7,36E-02
2,26E-01	2,16E-02
1,15E-01	4,46E-03
9,49E-02	5,82E-04
8,50E-03	2,11E-04



Brake Switch Characteristics

figure 8. IGBT

Typical output characteristics

$$I_C = f(V_{CE})$$

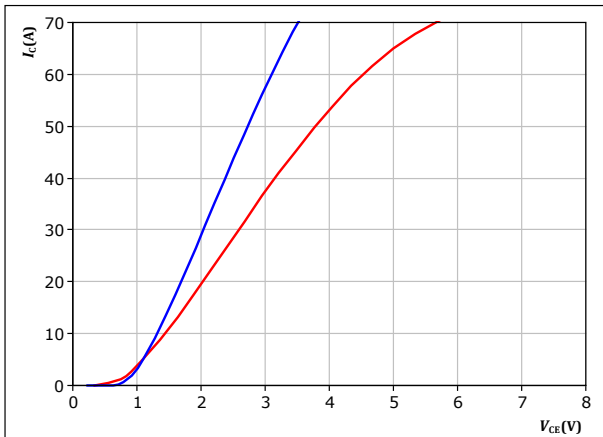

$t_p = 250 \mu s$
 $V_{GE} = 15 V$
 $T_j: 25^\circ C$ (blue), $150^\circ C$ (red)

figure 9. IGBT

Typical output characteristics

$$I_C = f(V_{CE})$$

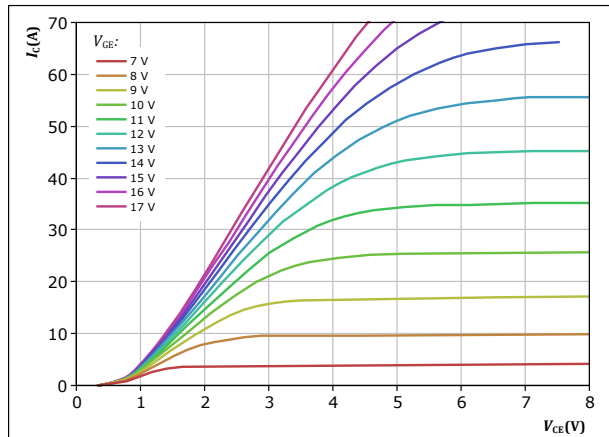

$t_p = 250 \mu s$
 $T_j = 150^\circ C$
 V_{GE} from 7 V to 17 V in steps of 1 V

figure 10. IGBT

Typical transfer characteristics

$$I_C = f(V_{GE})$$

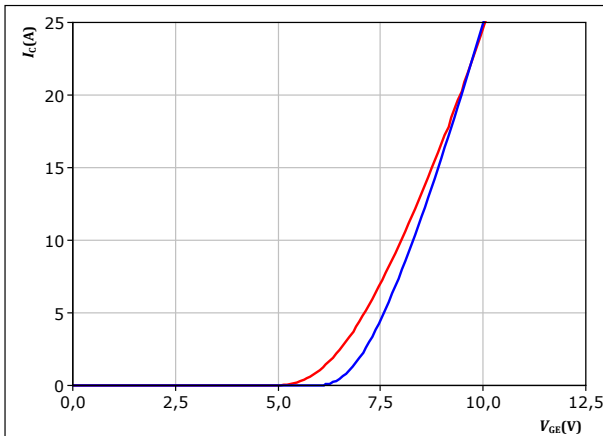

$t_p = 250 \mu s$
 $V_{CE} = 10 V$
 $T_j: 25^\circ C$ (blue), $150^\circ C$ (red)

figure 11. IGBT

Transient thermal impedance as a function of pulse width

$$Z_{th(j-s)} = f(t_p)$$

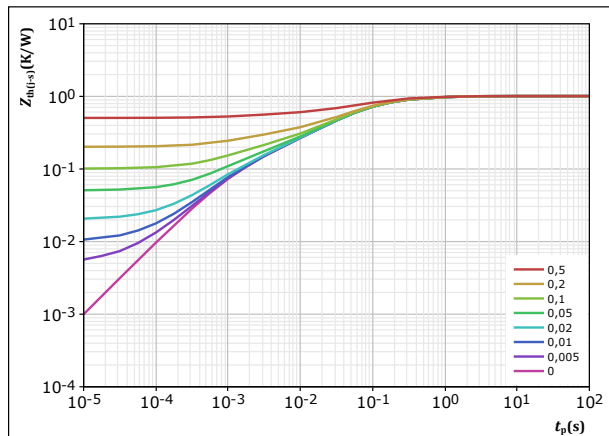

$D = t_p / T$
 $R_{th(j-s)} = 1,009 K/W$
IGBT thermal model values

R (K/W)	τ (s)
8,44E-02	1,03E+00
2,46E-01	1,79E-01
4,48E-01	5,38E-02
1,38E-01	1,04E-02
5,48E-02	1,66E-03
3,85E-02	8,73E-04



Brake Switch Characteristics

figure 12. IGBT

Safe operating area

$I_C = f(V_{CE})$

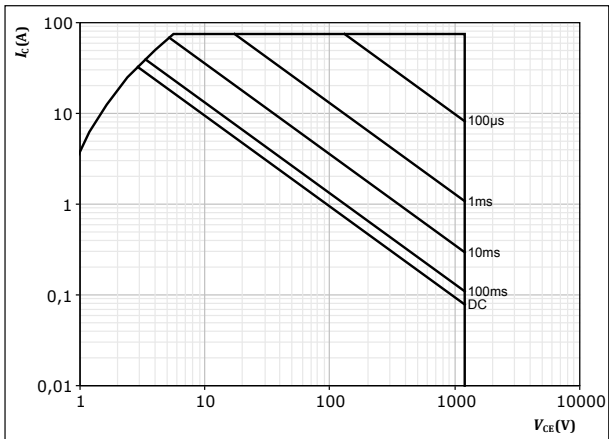

$D = \text{single pulse}$
 $T_s = 80 \text{ } ^\circ\text{C}$
 $V_{CE} = 15 \text{ V}$
 $T_j = T_{jmax}$



Brake Diode Characteristics

figure 13. FWD

Typical forward characteristics

$$I_F = f(V_F)$$

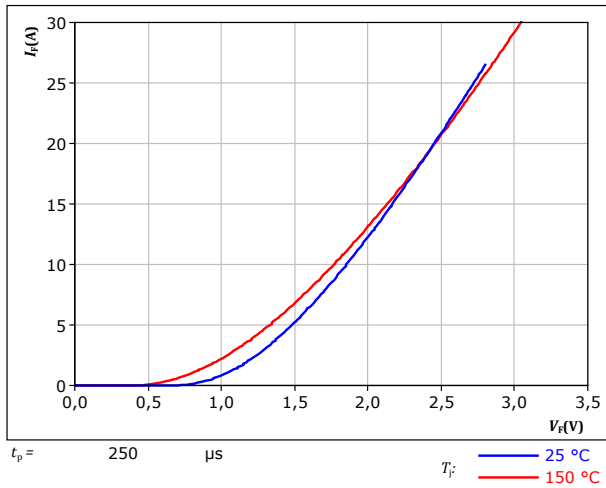
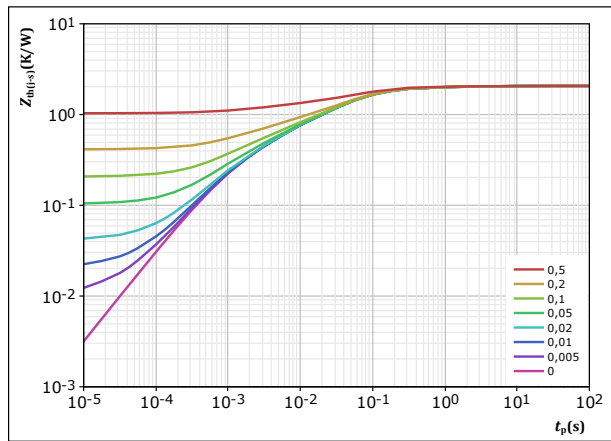

figure 14. FWD

Transient thermal impedance as a function of pulse width

$$Z_{th(j-s)} = f(t_p)$$



$D = t_p / T$

$R_{th(j-s)} = 2,066 \text{ K/W}$

FWD thermal model values

$R \text{ (K/W)}$	$\tau \text{ (s)}$
5,09E-02	4,26E+00
1,55E-01	5,03E-01
7,75E-01	7,89E-02
5,33E-01	2,68E-02
3,54E-01	5,03E-03
1,97E-01	9,09E-04



Rectifier Diode Characteristics

figure 15. Rectifier

Typical forward characteristics

$$I_F = f(V_F)$$

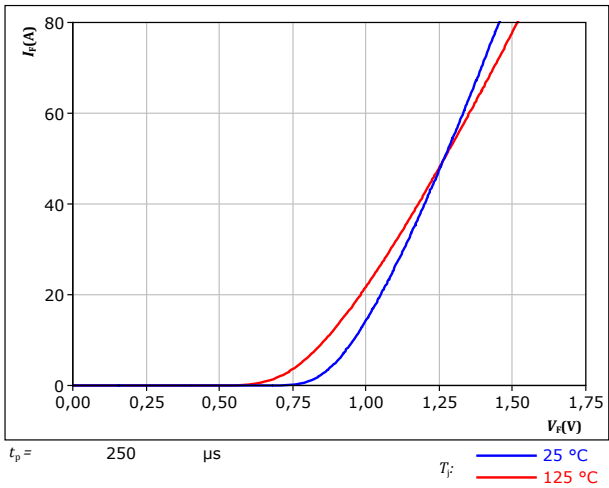
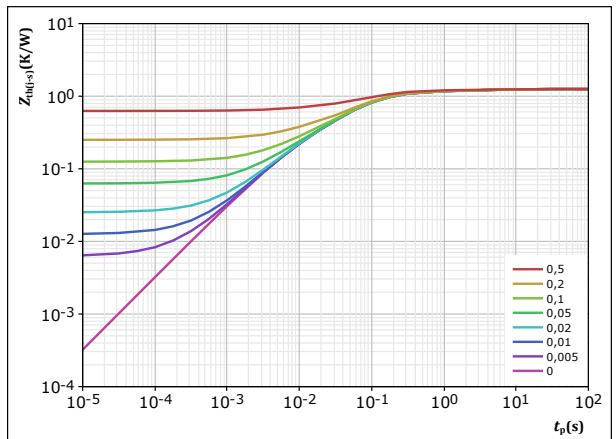

figure 16. Rectifier

Transient thermal impedance as a function of pulse width

$$Z_{th(j-s)} = f(t_p)$$



$D = t_p / T$

$R_{th(j-s)} = 1,254 \text{ K/W}$

Rectifier thermal model values

$R \text{ (K/W)}$	$\tau \text{ (s)}$
8,00E-02	5,22E+00
1,56E-01	4,18E-01
6,95E-01	8,82E-02
2,23E-01	3,07E-02
9,97E-02	5,99E-03



Thermistor Characteristics

figure 17. Thermistor

Typical NTC characteristic as function of temperature

$$R_T = f(T)$$

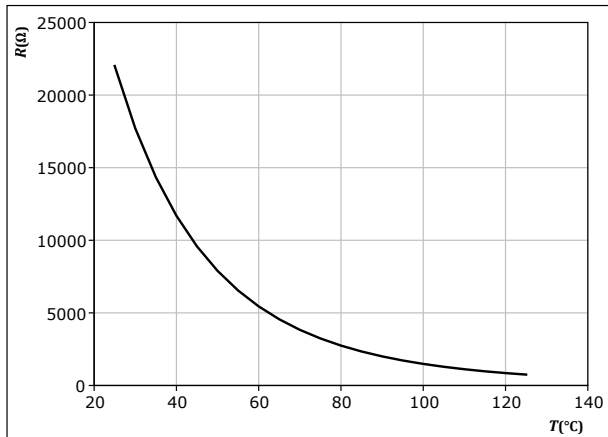



Inverter Switching Characteristics

figure 18. IGBT

Typical switching energy losses as a function of collector current
 $E = f(I_c)$

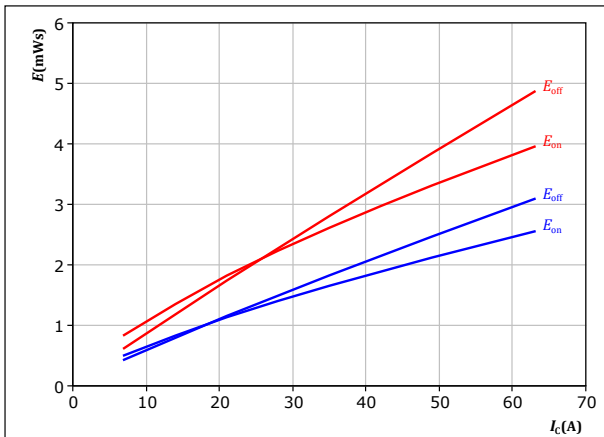

With an inductive load at
 $V_{CE} = 600$ V
 $V_{GE} = \pm 15$ V
 $R_{gon} = 16$ Ω
 $R_{goff} = 16$ Ω
 T_j : — 25 °C
— 150 °C

figure 19. IGBT

Typical switching energy losses as a function of gate resistor
 $E = f(R_g)$

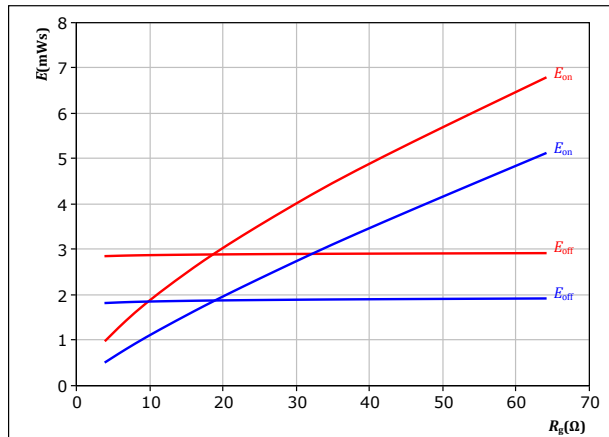

With an inductive load at
 $V_{CE} = 600$ V
 $V_{GE} = \pm 15$ V
 $I_c = 35$ A
 T_j : — 25 °C
— 150 °C

figure 20. FWD

Typical reverse recovered energy loss as a function of collector current
 $E_{rec} = f(I_c)$

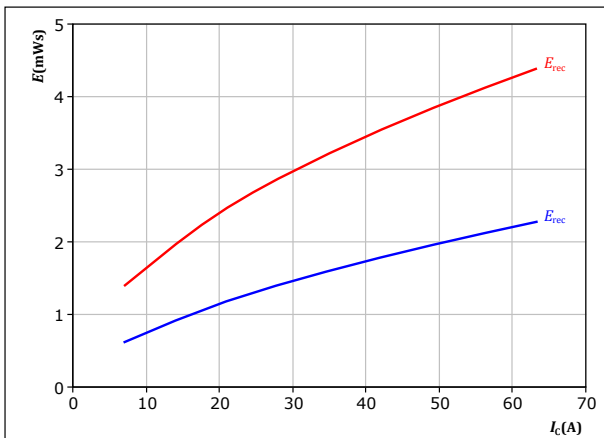

With an inductive load at
 $V_{CE} = 600$ V
 $V_{GE} = \pm 15$ V
 $R_{gon} = 16$ Ω
 T_j : — 25 °C
— 150 °C

figure 21. FWD

Typical reverse recovered energy loss as a function of gate resistor
 $E_{rec} = f(R_g)$

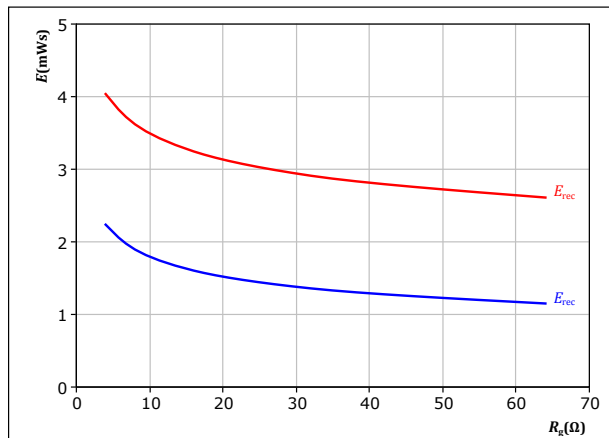

With an inductive load at
 $V_{CE} = 600$ V
 $V_{GE} = \pm 15$ V
 $I_c = 35$ A
 T_j : — 25 °C
— 150 °C



Inverter Switching Characteristics

figure 22. IGBT

Typical switching times as a function of collector current
 $t = f(I_c)$

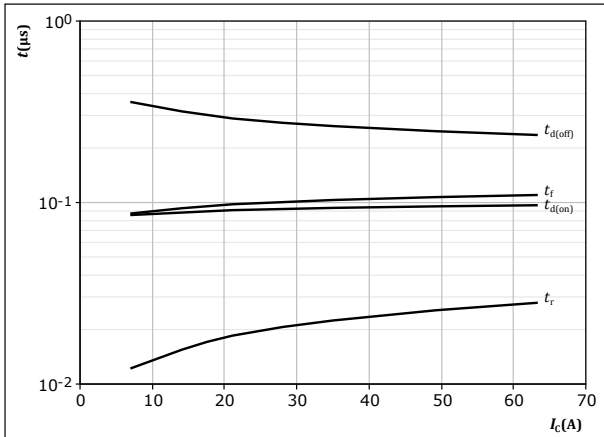

With an inductive load at
 $T_j = 150 \text{ }^\circ\text{C}$
 $V_{CE} = 600 \text{ V}$
 $V_{GE} = \pm 15 \text{ V}$
 $R_{g(on)} = 16 \text{ } \Omega$
 $R_{g(off)} = 16 \text{ } \Omega$

figure 23. IGBT

Typical switching times as a function of gate resistor
 $t = f(R_g)$

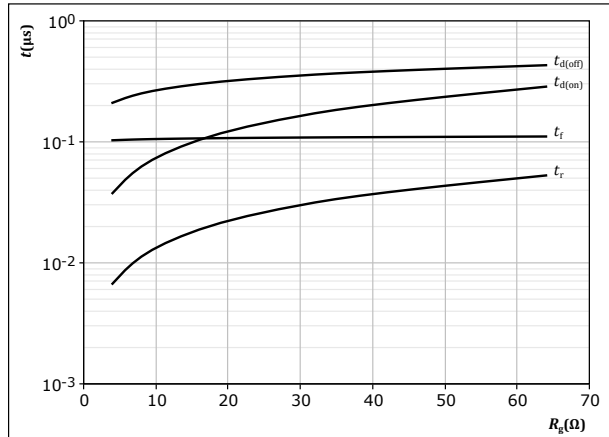

With an inductive load at
 $T_j = 150 \text{ }^\circ\text{C}$
 $V_{CE} = 600 \text{ V}$
 $V_{GE} = \pm 15 \text{ V}$
 $I_c = 35 \text{ A}$

figure 24. FWD

Typical reverse recovery time as a function of collector current
 $t_{rr} = f(I_c)$

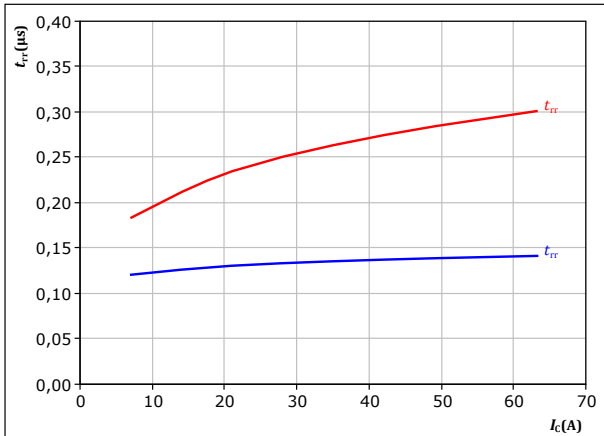

With an inductive load at
 $V_{CE} = 600 \text{ V}$
 $V_{GE} = \pm 15 \text{ V}$
 $R_{g(on)} = 16 \text{ } \Omega$
 $T_j: \text{ — } 25 \text{ }^\circ\text{C}$
 $\text{ — } 150 \text{ }^\circ\text{C}$

figure 25. FWD

Typical reverse recovery time as a function of IGBT turn off gate resistor
 $t_{rr} = f(R_{g(off)})$

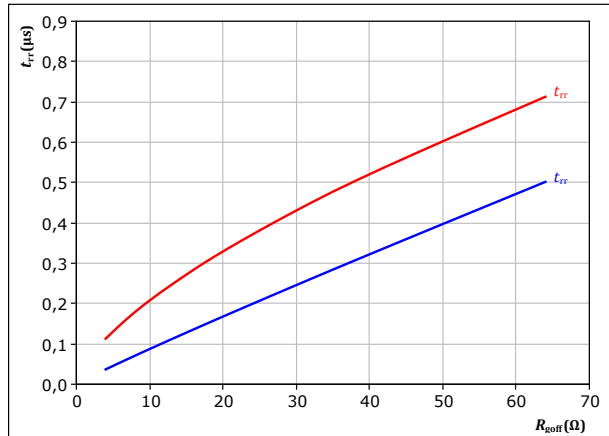

With an inductive load at
 $V_{CE} = 600 \text{ V}$
 $V_{GE} = \pm 15 \text{ V}$
 $I_c = 35 \text{ A}$
 $T_j: \text{ — } 25 \text{ }^\circ\text{C}$
 $\text{ — } 150 \text{ }^\circ\text{C}$



Inverter Switching Characteristics

figure 26. FWD

Typical recovered charge as a function of collector current

$$Q_r = f(I_c)$$

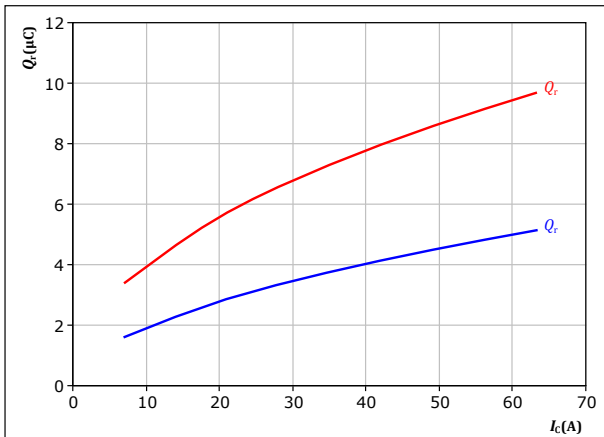

With an inductive load at

$V_{CE} = 600$ V
 $V_{GE} = \pm 15$ V
 $R_{goff} = 16$ Ω

T_j : — 25 °C
— 150 °C

figure 27. FWD

Typical recovered charge as a function of turn off gate resistor

$$Q_r = f(R_{goff})$$

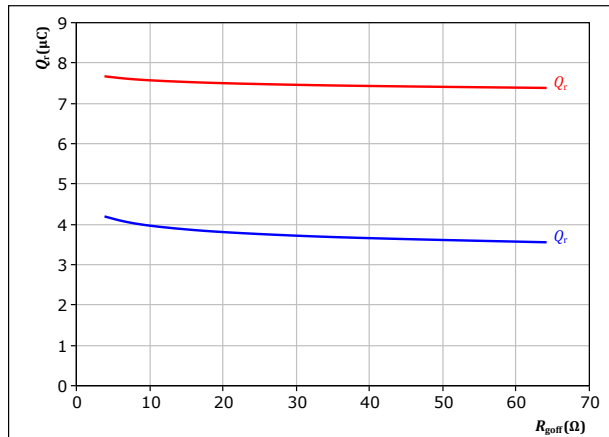

With an inductive load at

$V_{CE} = 600$ V
 $V_{GE} = \pm 15$ V
 $I_c = 35$ A

T_j : — 25 °C
— 150 °C

figure 28. FWD

Typical peak reverse recovery current as a function of collector current

$$I_{RM} = f(I_c)$$

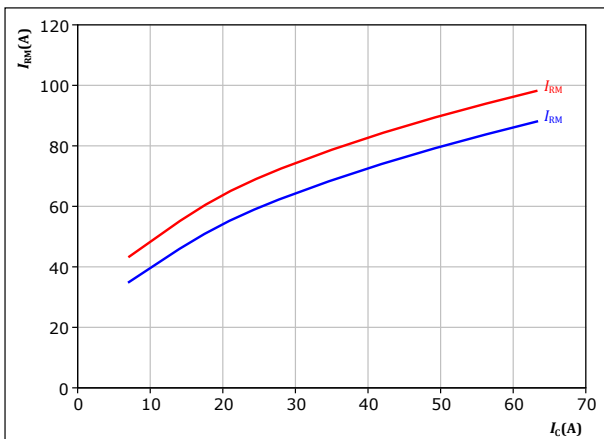

With an inductive load at

$V_{CE} = 600$ V
 $V_{GE} = \pm 15$ V
 $R_{goff} = 16$ Ω

T_j : — 25 °C
— 150 °C

figure 29. FWD

Typical peak reverse recovery current as a function of turn off gate resistor

$$I_{RM} = f(R_{goff})$$

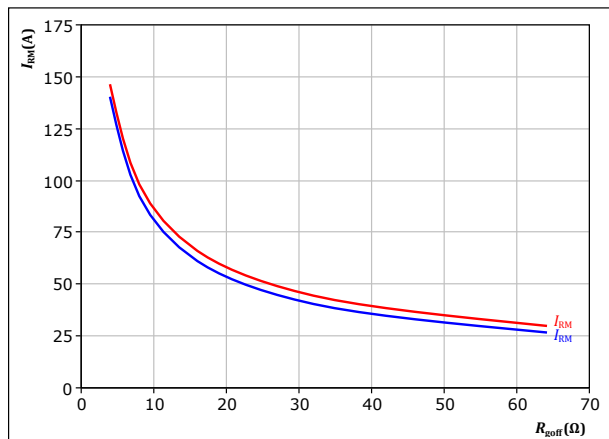

With an inductive load at

$V_{CE} = 600$ V
 $V_{GE} = \pm 15$ V
 $I_c = 35$ A

T_j : — 25 °C
— 150 °C



Inverter Switching Characteristics

figure 30. FWD

Typical rate of fall of forward and reverse recovery current as a function of collector current
 $di_f/dt, di_r/dt = f(I_c)$

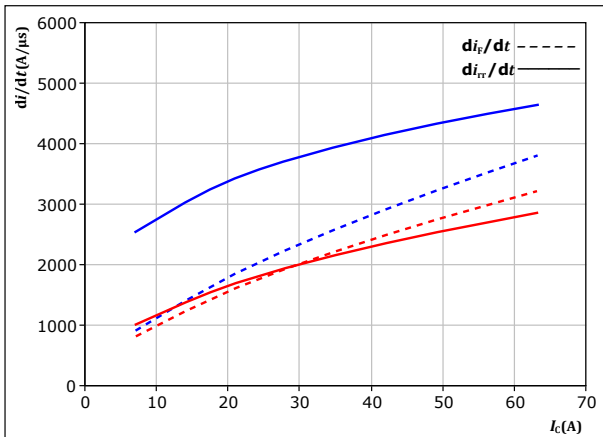

With an inductive load at

$V_{CE} = 600 \text{ V}$
 $V_{GE} = \pm 15 \text{ V}$
 $R_{goff} = 16 \text{ } \Omega$

T_j : — 25 °C
 — 150 °C

figure 31. FWD

Typical rate of fall of forward and reverse recovery current as a function of turn off gate resistor
 $di_f/dt, di_r/dt = f(R_{goff})$

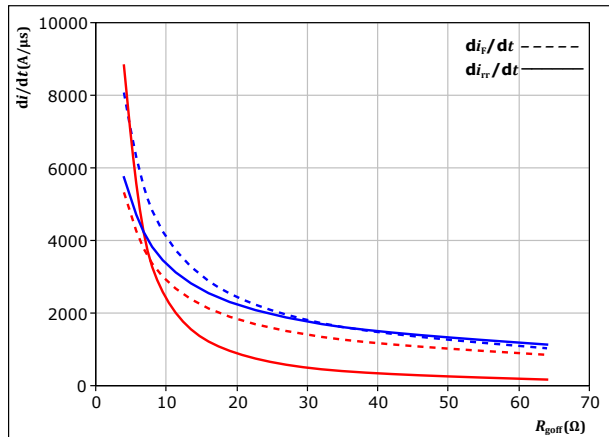

With an inductive load at

$V_{CE} = 600 \text{ V}$
 $V_{GE} = \pm 15 \text{ V}$
 $I_c = 35 \text{ A}$

T_j : — 25 °C
 — 150 °C

figure 32. IGBT

Reverse bias safe operating area

$I_c = f(V_{CE})$

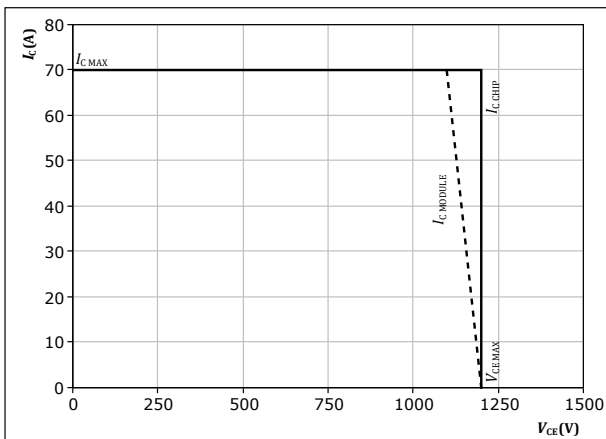

At $T_j = 150 \text{ } ^\circ\text{C}$
 $R_{goff} = 16 \text{ } \Omega$
 $R_{goff} = 16 \text{ } \Omega$



Brake Switching Characteristics

figure 33. IGBT

Typical switching energy losses as a function of collector current
 $E = f(I_c)$

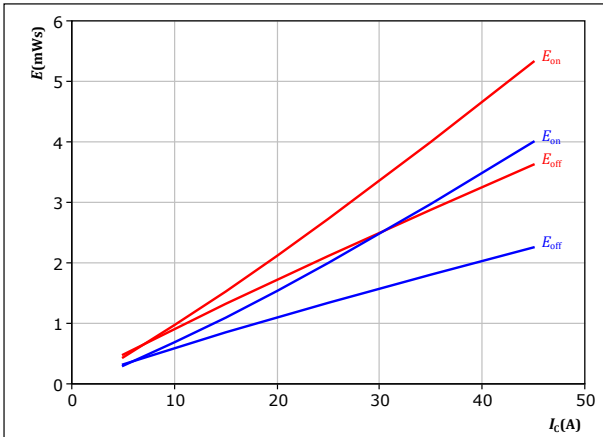

With an inductive load at

$V_{CE} = 600$ V
 $V_{GE} = \pm 15$ V
 $R_{gon} = 32$ Ω
 $R_{goff} = 32$ Ω

T_j : — 25 °C
 — 150 °C

figure 34. IGBT

Typical switching energy losses as a function of gate resistor
 $E = f(R_g)$

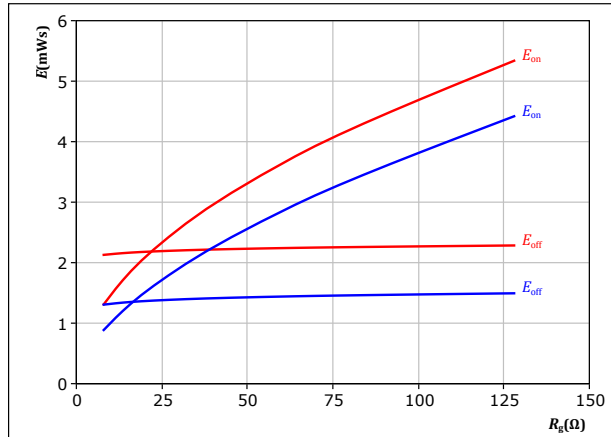

With an inductive load at

$V_{CE} = 600$ V
 $V_{GE} = \pm 15$ V
 $I_c = 25$ A

T_j : — 25 °C
 — 150 °C

figure 35. FWD

Typical reverse recovered energy loss as a function of collector current
 $E_{rec} = f(I_c)$

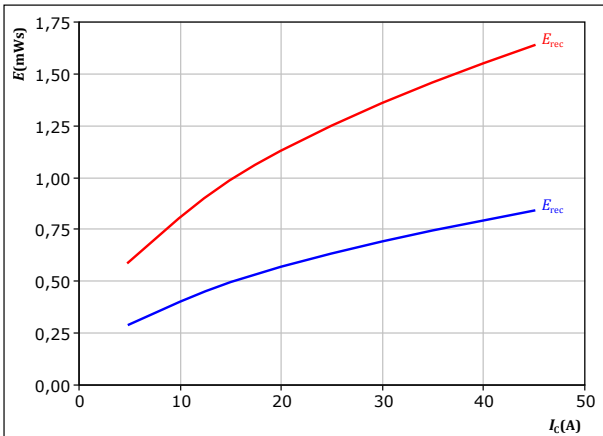

With an inductive load at

$V_{CE} = 600$ V
 $V_{GE} = \pm 15$ V
 $R_{gon} = 32$ Ω

T_j : — 25 °C
 — 150 °C

figure 36. FWD

Typical reverse recovered energy loss as a function of gate resistor
 $E_{rec} = f(R_g)$

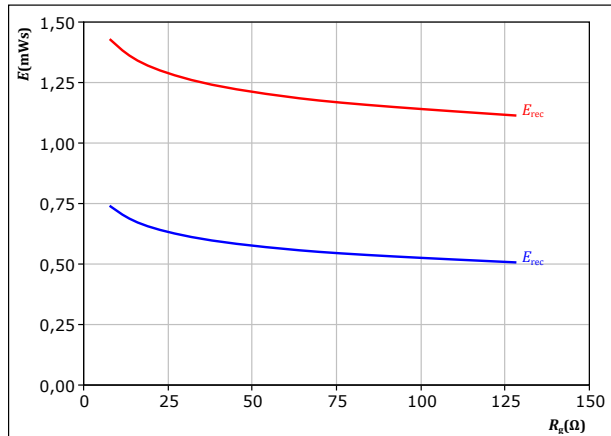

With an inductive load at

$V_{CE} = 600$ V
 $V_{GE} = \pm 15$ V
 $I_c = 25$ A

T_j : — 25 °C
 — 150 °C



Brake Switching Characteristics

figure 37. IGBT

Typical switching times as a function of collector current
 $t = f(I_c)$

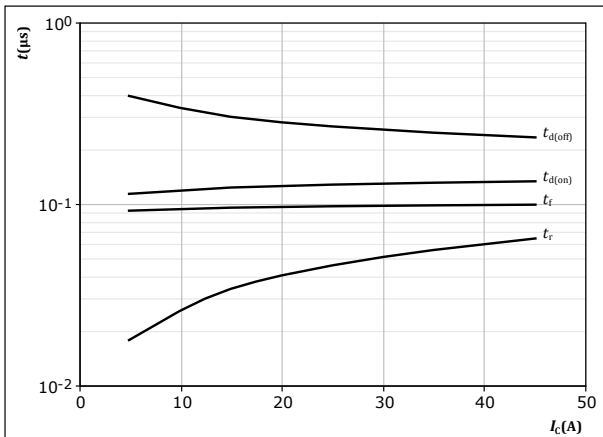

With an inductive load at
 $T_j = 150 \text{ }^\circ\text{C}$
 $V_{CE} = 600 \text{ V}$
 $V_{GE} = \pm 15 \text{ V}$
 $R_{g(on)} = 32 \text{ } \Omega$
 $R_{g(off)} = 32 \text{ } \Omega$

figure 38. IGBT

Typical switching times as a function of gate resistor
 $t = f(R_g)$

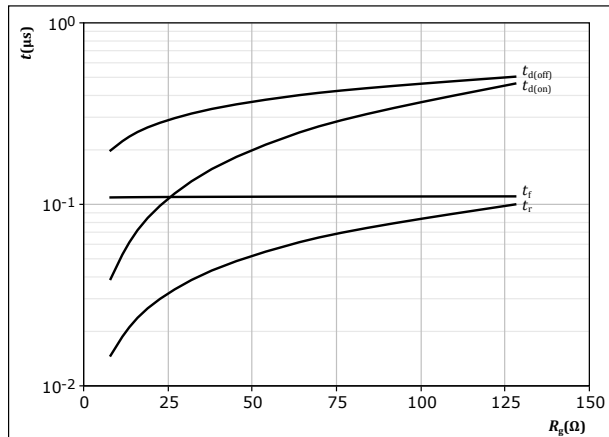

With an inductive load at
 $T_j = 150 \text{ }^\circ\text{C}$
 $V_{CE} = 600 \text{ V}$
 $V_{GE} = \pm 15 \text{ V}$
 $I_c = 25 \text{ A}$

figure 39. FWD

Typical reverse recovery time as a function of collector current
 $t_{rr} = f(I_c)$

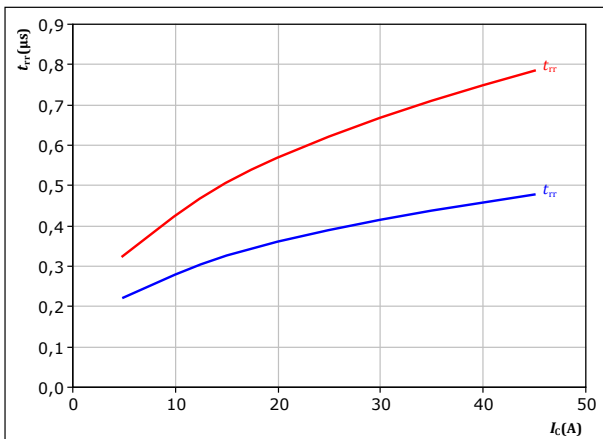

With an inductive load at
 $V_{CE} = 600 \text{ V}$
 $V_{GE} = \pm 15 \text{ V}$
 $R_{g(on)} = 32 \text{ } \Omega$
 $T_j: \text{ — } 25 \text{ }^\circ\text{C}$
 $\text{ — } 150 \text{ }^\circ\text{C}$

figure 40. FWD

Typical reverse recovery time as a function of IGBT turn off gate resistor
 $t_{rr} = f(R_{g(off)})$

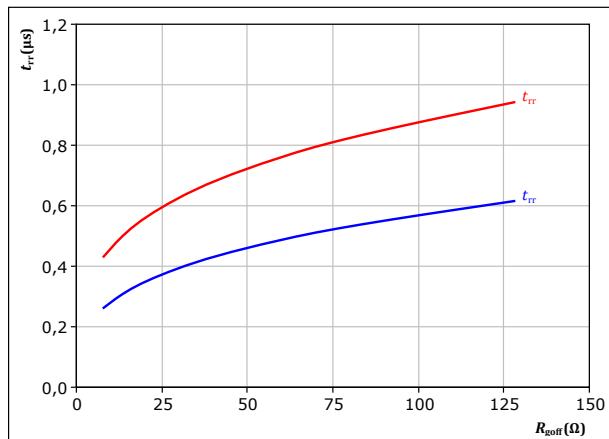

With an inductive load at
 $V_{CE} = 600 \text{ V}$
 $V_{GE} = \pm 15 \text{ V}$
 $I_c = 25 \text{ A}$
 $T_j: \text{ — } 25 \text{ }^\circ\text{C}$
 $\text{ — } 150 \text{ }^\circ\text{C}$



Brake Switching Characteristics

figure 41. FWD

Typical recovered charge as a function of collector current

$$Q_r = f(I_c)$$

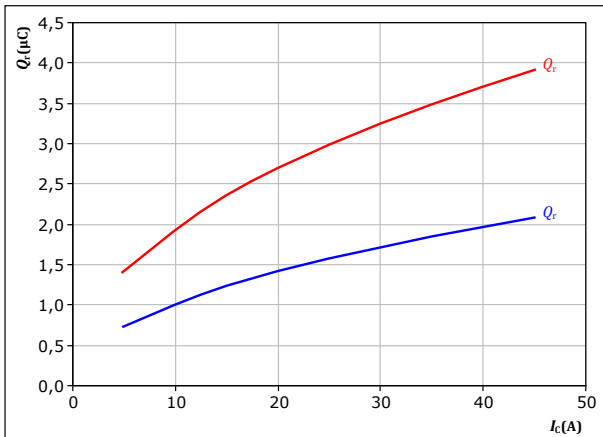

With an inductive load at

$V_{CE} = 600$ V
 $V_{GE} = \pm 15$ V
 $R_{goff} = 32$ Ω

T_j : — 25 °C
— 150 °C

figure 42. FWD

Typical recovered charge as a function of turn off gate resistor

$$Q_r = f(R_{goff})$$

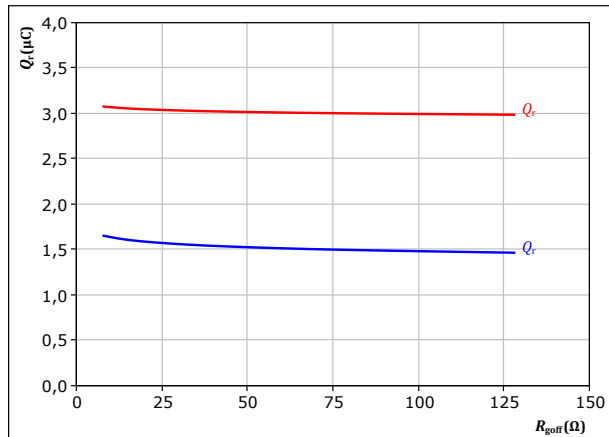

With an inductive load at

$V_{CE} = 600$ V
 $V_{GE} = \pm 15$ V
 $I_c = 25$ A

T_j : — 25 °C
— 150 °C

figure 43. FWD

Typical peak reverse recovery current as a function of collector current

$$I_{RM} = f(I_c)$$

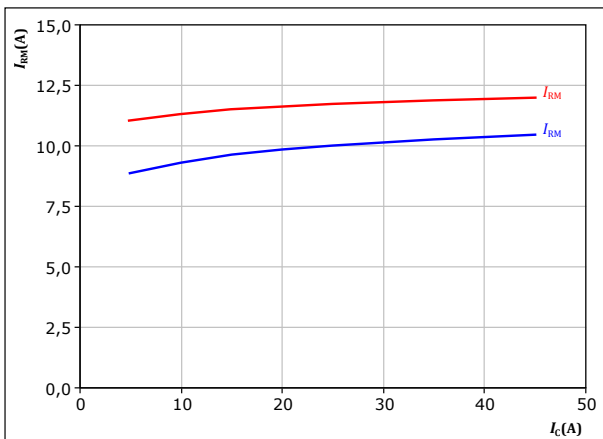

With an inductive load at

$V_{CE} = 600$ V
 $V_{GE} = \pm 15$ V
 $R_{goff} = 32$ Ω

T_j : — 25 °C
— 150 °C

figure 44. FWD

Typical peak reverse recovery current as a function of turn off gate resistor

$$I_{RM} = f(R_{goff})$$

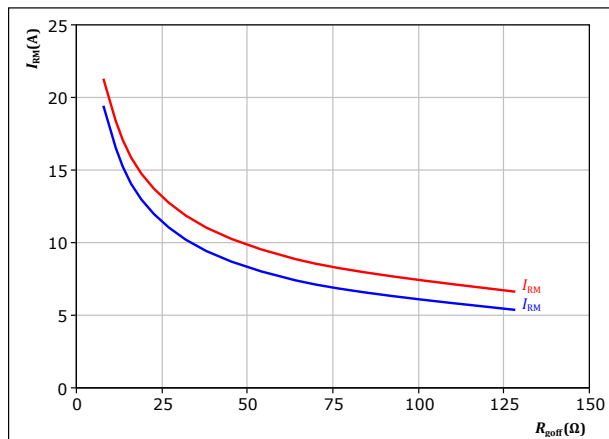

With an inductive load at

$V_{CE} = 600$ V
 $V_{GE} = \pm 15$ V
 $I_c = 25$ A

T_j : — 25 °C
— 150 °C



Brake Switching Characteristics

figure 45. FWD

Typical rate of fall of forward and reverse recovery current as a function of collector current
 $di_f/dt, di_r/dt = f(I_c)$

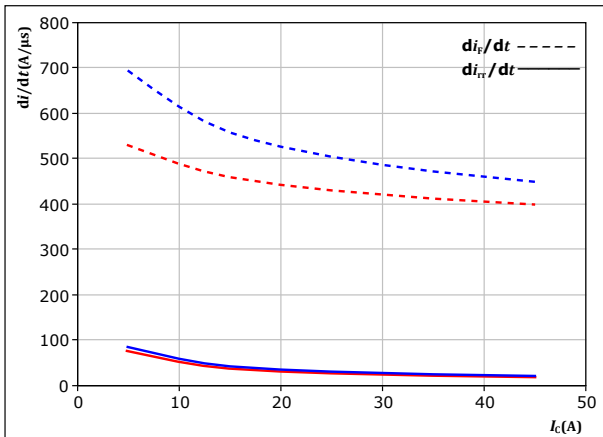

With an inductive load at

$V_{CE} = 600 \text{ V}$
 $V_{GE} = \pm 15 \text{ V}$
 $R_{goff} = 32 \ \Omega$

T_j : — 25 °C
 — 150 °C

figure 46. FWD

Typical rate of fall of forward and reverse recovery current as a function of turn off gate resistor
 $di_f/dt, di_r/dt = f(R_{goff})$

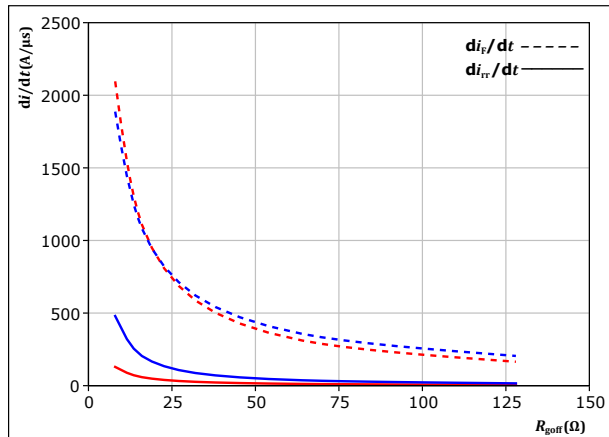

With an inductive load at

$V_{CE} = 600 \text{ V}$
 $V_{GE} = \pm 15 \text{ V}$
 $I_c = 25 \text{ A}$

T_j : — 25 °C
 — 150 °C

figure 47. IGBT

Reverse bias safe operating area

$I_c = f(V_{CE})$

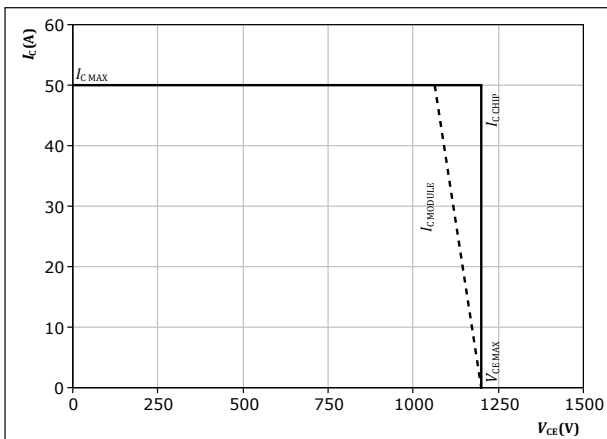

At $T_j = 150 \text{ °C}$
 $R_{goff} = 32 \ \Omega$
 $R_{goff} = 32 \ \Omega$



Switching Definitions

figure 48. IGBT

Turn-off Switching Waveforms & definition of t_{doff} , t_{Eoff} (t_{Eoff} = integrating time for E_{off})

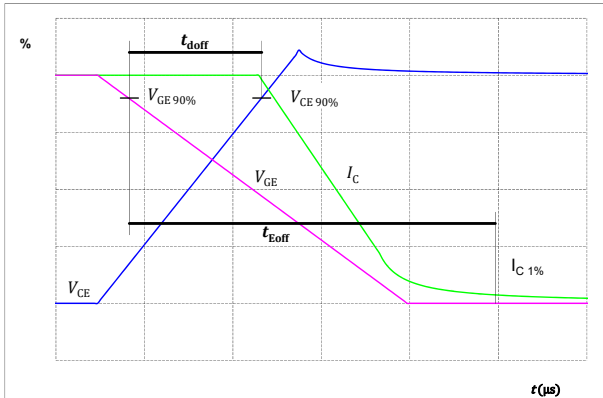

figure 49. IGBT

Turn-on Switching Waveforms & definition of t_{don} , t_{Eon} (t_{Eon} = integrating time for E_{on})

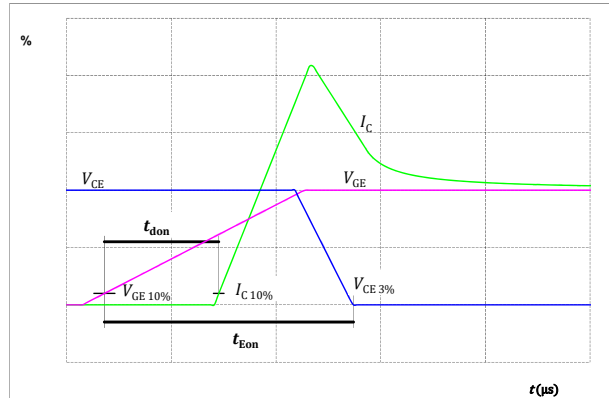

figure 50. IGBT

Turn-off Switching Waveforms & definition of t_f

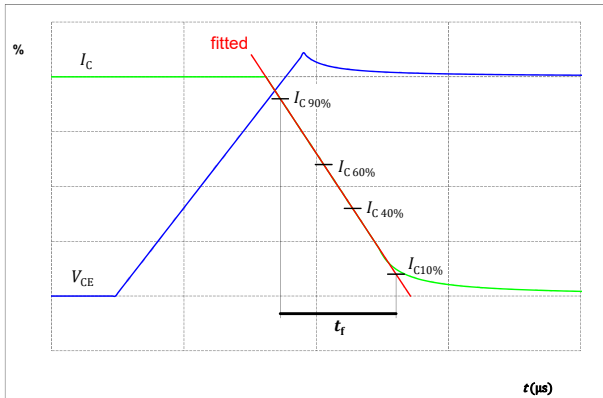
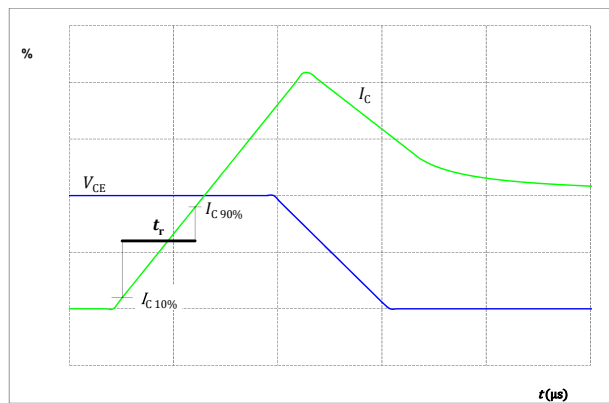

figure 51. IGBT

Turn-on Switching Waveforms & definition of t_r





Switching Definitions

figure 52. FWD

Turn-off Switching Waveforms & definition of t_{rr}

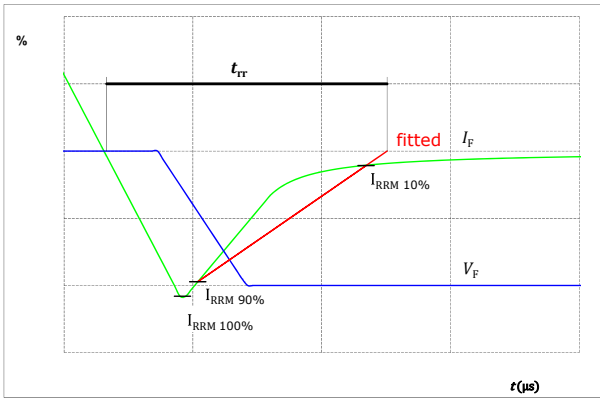
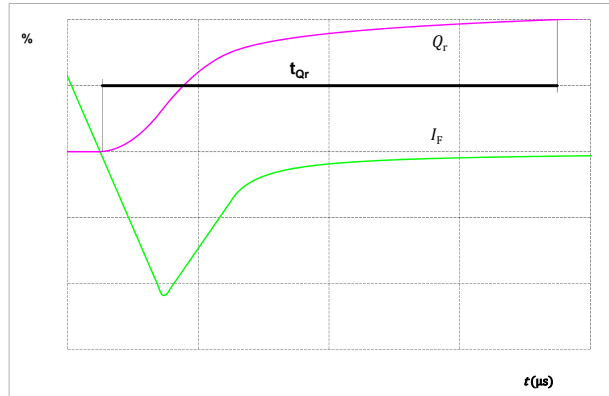

figure 53. FWD

Turn-on Switching Waveforms & definition of t_{Qr} (t_{Qr} = integrating time for Q_r)





Vincotech

V23990-P580-C41-PM
datasheet

Ordering Code	
Version	Ordering Code
Without thermal paste	V23990-P580-C41-PM
With thermal paste (5,2 W/mK, PTM6000HV)	V23990-P580-C41-/-7/-PM
With thermal paste (3,4 W/mK, PSX-P7)	V23990-P580-C41-/-3/-PM

Marking							
	Text	VIN	Date code	Type&Ver	UL	Lot	Serial
		VIN	WWYY	TTTTTUVV	UL	LLLLL	SSSS
	Datamatrix	Type&Ver	Lot number	Serial	Date code		
		TTTTTUVV	LLLLL	SSSS	WWYY		

Outline				
Pin table [mm]				
Pin	X	Y	Function	
1	not assembled			
2	47,7	0	DC-	
3	44,8	0	DC-	
4	37,8	0	DC+	
5	37,8	2,8	DC+	
6	35	0	Inv+	
7	35	2,8	Inv+	
8	28	0	R1	
9	25,2	0	R2	
10	22,4	0	N6	
11	19,6	0	G6	
12	16,8	0	S6	
13	14	0	N4	
14	11,2	0	G4	
15	8,4	0	S4	
16	5,6	0	N2	
17	2,8	0	G2	
18	0	0	S2	
19	0	28,5	U	
20	2,8	28,5	G1	
21	7,5	28,5	S1	
22	14,5	28,5	V	
23	17,3	28,5	G3	
24	22	28,5	S3	
25	29	28,5	W	
26	31,8	28,5	G5	
27	36,5	28,5	S5	
28	43,5	28,5	L1	
29	52,55	25	L2	
30	52,55	16,9	L3	
31	not assembled			
32	not assembled			

Tolerance of pins: ±0.5mm at the end of pins.
Dimension of coordinate axis is only of fast without tolerance.



Vincotech

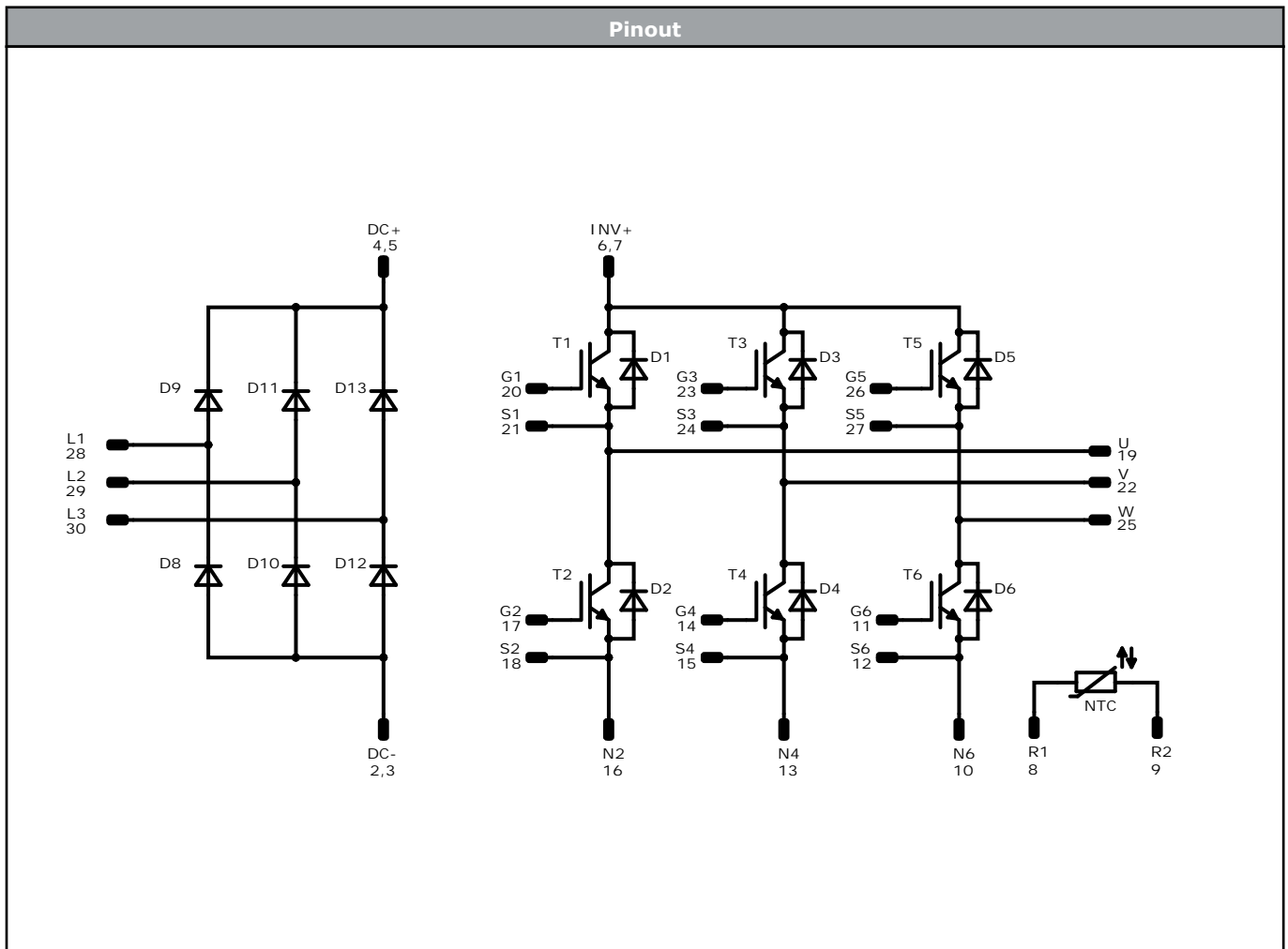

Identification					
ID	Component	Voltage	Current	Function	Comment
T2, T1, T4, T3, T6, T5	IGBT	1200 V	35 A	Inverter Switch	
D1, D2, D3, D4, D5, D6	FWD	1200 V	35 A	Inverter Diode	
T7	IGBT	1200 V	25 A	Brake Switch	
D7	FWD	1200 V	10 A	Brake Diode	
D8, D9, D10, D11, D12, D13	Rectifier	1600 V	35 A	Rectifier Diode	
NTC	NTC			Thermistor	



Vincotech

Packaging instruction				
Standard packaging quantity (SPQ) 100	>SPQ	Standard	<SPQ	Sample

Handling instruction
Handling instructions for <i>flow 1</i> packages see vincotech.com website.

Package data
Package data for <i>flow 1</i> packages see vincotech.com website.

Vincotech thermistor reference
See Vincotech thermistor reference table at vincotech.com website.

UL recognition and file number
This device is certified according to UL 1557 standard, UL file number E192116. For more information see vincotech.com website. 

Document No.:	Date:	Modification:	Pages
V23990-P580-C41-PM-D10-14	21 Sep. 2021	Rectifier maximum ratings are updated Rectifier characteristic value condition is changed Inverter Switch and Thermistor characteristic values are updated Separated datasheet New datasheet format, module is unchanged	

DISCLAIMER

The information, specifications, procedures, methods and recommendations herein (together "information") are presented by Vincotech to reader in good faith, are believed to be accurate and reliable, but may well be incomplete and/or not applicable to all conditions or situations that may exist or occur. Vincotech reserves the right to make any changes without further notice to any products to improve reliability, function or design. No representation, guarantee or warranty is made to reader as to the accuracy, reliability or completeness of said information or that the application or use of any of the same will avoid hazards, accidents, losses, damages or injury of any kind to persons or property or that the same will not infringe third parties rights or give desired results. It is reader's sole responsibility to test and determine the suitability of the information and the product for reader's intended use.

LIFE SUPPORT POLICY

Vincotech products are not authorised for use as critical components in life support devices or systems without the express written approval of Vincotech.

As used herein:

1. Life support devices or systems are devices or systems which, (a) are intended for surgical implant into the body, or (b) support or sustain life, or (c) whose failure to perform when properly used in accordance with instructions for use provided in labelling can be reasonably expected to result in significant injury to the user.
2. A critical component is any component of a life support device or system whose failure to perform can be reasonably expected to cause the failure of the life support device or system, or to affect its safety or effectiveness.