

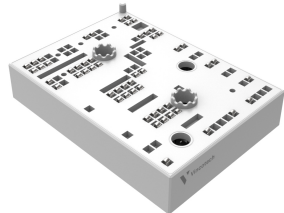
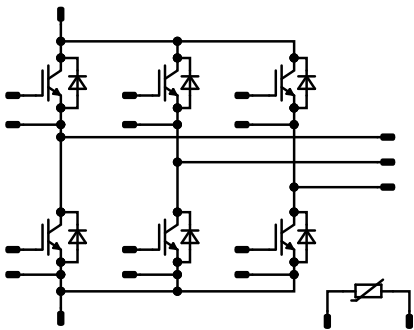

MiniSKiiP® PACK 3		1200 V / 150 A	
Features <ul style="list-style-type: none">• Solderless interconnection• Trench Fieldstop IGBT4 technology		MiniSKiiP® 3 16 mm housing 	
Target applications <ul style="list-style-type: none">• Servo Drives• Industrial Motor Drives• UPS		Schematic 	
Types <ul style="list-style-type: none">• V23990-K430-F40-PM			

**Maximum Ratings** $T_j = 25\text{ °C}$, unless otherwise specified

Parameter	Symbol	Conditions	Value	Unit
Inverter Switch				
Collector-emitter voltage	V_{CES}		1200	V
Collector current	I_C	$T_j = T_{jmax}$ $T_s = 80\text{ °C}$	163	A
Repetitive peak collector current	I_{CRM}	t_p limited by T_{jmax}	450	A
Total power dissipation	P_{tot}	$T_j = T_{jmax}$ $T_s = 80\text{ °C}$	453	W
Gate-emitter voltage	V_{GES}		± 20	V
Short circuit ratings	t_{SC}	$V_{GE} = 15\text{ V}$, $V_{CC} = 800\text{ V}$ $T_j = 150\text{ °C}$	10	μs
Maximum junction temperature	T_{jmax}		175	$^{\circ}\text{C}$

Inverter Diode

Peak repetitive reverse voltage	V_{RRM}		1200	V
Continuous (direct) forward current	I_F	$T_j = T_{jmax}$ $T_s = 80\text{ °C}$	114	A
Surge (non-repetitive) forward current	I_{FSM}	Single Half Sine Wave, $t_p = 10\text{ ms}$ $T_j = 150\text{ °C}$	900	A
Surge current capability	I^2t		4050	A^2s
Total power dissipation	P_{tot}	$T_j = T_{jmax}$ $T_s = 80\text{ °C}$	249	W
Maximum junction temperature	T_{jmax}		175	$^{\circ}\text{C}$

Module Properties**Thermal Properties**

Storage temperature	T_{stg}		-40...+125	$^{\circ}\text{C}$
Operation temperature under switching condition	T_{jop}		-40...+($T_{jmax} - 25$)	$^{\circ}\text{C}$

Isolation Properties

Isolation voltage	V_{isol}	DC Test Voltage* $t_p = 2\text{ s}$	5500	V
Isolation voltage	V_{isol}	AC Voltage $t_p = 1\text{ min}$	2500	V
Creepage distance		With std lid For more informations see handling instructions	6,3	mm
Clearance		With std lid For more informations see handling instructions	6,3	mm
Comparative Tracking Index	CTI		≥ 600	

*100 % tested in production



Characteristic Values

Parameter	Symbol	Conditions					Values			Unit
		V_{GS} [V]	V_{GE} [V]	V_{DS} [V]	V_F [V]	I_C [A] I_D [A] I_F [A]	T_j [°C]	Min	Typ	

Inverter Switch

Static

Gate-emitter threshold voltage	$V_{GE(th)}$	$V_{CE} = V_{GE}$			0,0052	25	5,3	5,8	6,3	V
Collector-emitter saturation voltage	$V_{CE(sat)}$		15		150	25 150	1,58	2,04 2,5	2,07 ⁽¹⁾	V
Collector-emitter cut-off current	I_{CES}		0	1200		25			2	μA
Gate-emitter leakage current	I_{GES}		20	0		25			240	nA
Internal gate resistance	r_g							5		Ω
Input capacitance	C_{ies}	$f = 1 \text{ Mhz}$	0	25		25		8600		pF
Reverse transfer capacitance	C_{res}									
Gate charge	Q_g		15		0	25		1140		nC

Thermal

Thermal resistance junction to sink ⁽²⁾	$R_{th(j-s)}$	$\lambda_{paste} = 2,5 \text{ W/mK}$ (HPTP)						0,21		K/W
--	---------------	--	--	--	--	--	--	------	--	-----

Dynamic

Turn-on delay time	$t_{d(on)}$	$R_{gon} = 2 \Omega$ $R_{goff} = 2 \Omega$	±15	600	150	25		175		ns
Rise time	t_r					150		192,6		ns
						25		46,2		ns
Turn-off delay time	$t_{d(off)}$					150		288,4		ns
						25		375,4		ns
Fall time	t_f					25		58,36		ns
						150		99,6		ns
Turn-on energy (per pulse)	E_{on}	$Q_{tFWD} = 7,99 \mu\text{C}$				25		14,99		mWs
		$Q_{tFWD} = 24,28 \mu\text{C}$				150		23,03		mWs
Turn-off energy (per pulse)	E_{off}					25		8,26		mWs
						150		14,15		mWs



Characteristic Values

Parameter	Symbol	Conditions					Values			Unit
		V_{GE} [V] V_{GS} [V]	V_{CE} [V] V_{DS} [V] V_F [V]	I_C [A] I_D [A] I_F [A]	T_j [°C]	Min	Typ	Max		
Inverter Diode										
Static										
Forward voltage	V_F			150	25 150		2,51 2,54	2,46 ⁽¹⁾ 2,38 ⁽¹⁾		V
Reverse leakage current	I_R	$V_i = 1200$ V			25 150			180 28000		μA
Thermal										
Thermal resistance junction to sink ⁽²⁾	$R_{th(j-s)}$	$\lambda_{paste} = 2,5$ W/mK (HPTP)						0,38		K/W
Dynamic										
Peak recovery current	I_{RRM}	$di/dt=2520$ A/μs $di/dt=2365$ A/μs	±15	600	150	25		76,98		A
Reverse recovery time	t_{rr}					150		106,92		ns
						25		124,75		
Recovered charge	Q_r					150		491,64		μC
						25		7,99		
Reverse recovered energy	E_{rec}					150		24,28		mWs
		25		2,13						
Peak rate of fall of recovery current	$(di_{rr}/dt)_{max}$	150		990		A/μs				
		25		1268						



Characteristic Values

Parameter	Symbol	Conditions					Values			Unit
		V_{GS} [V]	V_{GE} [V]	V_{DS} [V]	V_{CE} [V]	I_D [A]	I_C [A]	T_j [°C]	Min	

Thermistor

Static

Rated resistance	R					25		1		kΩ
Deviation of R_{100}	$A_{R/R}$	$R_{100} = 1670 \Omega$				100	-2		2	%
Maximum Current	I_{max}							3		mA
Power dissipation constant	d					25		0,76		mW/K
A-value	A							$7,635 \times 10^{-3}$		1/K
B-value	B							$1,73 \times 10^{-5}$		1/K ²
Vincotech Thermistor Reference									E	

⁽¹⁾ Value at chip level

⁽²⁾ Only valid with pre-applied Vincotech thermal interface material.



Inverter Switch Characteristics

figure 1. IGBT

Typical output characteristics
 $I_C = f(V_{CE})$

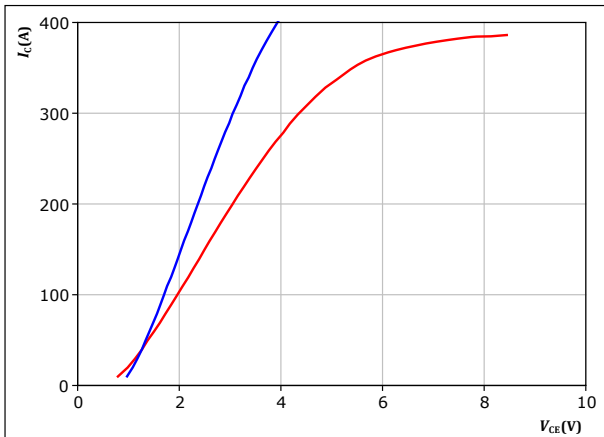

$t_p = 250 \mu s$
 $V_{GE} = 15 V$
 $T_j: 25^\circ C$ (blue), $150^\circ C$ (red)

figure 2. IGBT

Typical output characteristics
 $I_C = f(V_{CE})$

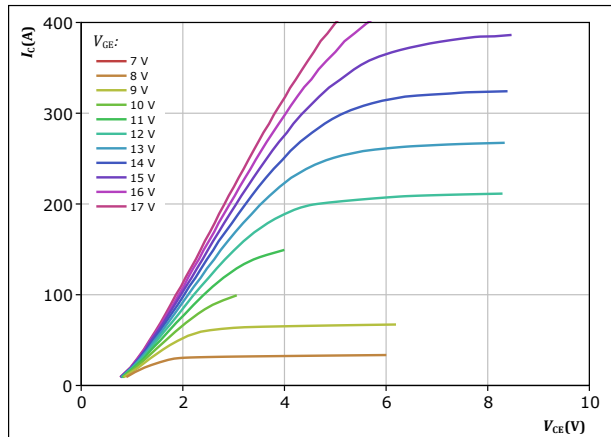

$t_p = 250 \mu s$
 $T_j = 150^\circ C$
 V_{GE} from 7 V to 17 V in steps of 1 V

figure 3. IGBT

Typical transfer characteristics
 $I_C = f(V_{GE})$

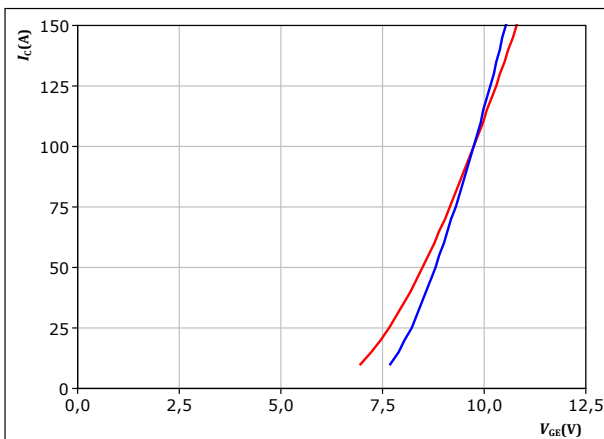

$t_p = 250 \mu s$
 $V_{CE} = 10 V$
 $T_j: 25^\circ C$ (blue), $150^\circ C$ (red)

figure 4. IGBT

Transient thermal impedance as a function of pulse width
 $Z_{th(j-s)} = f(t_p)$

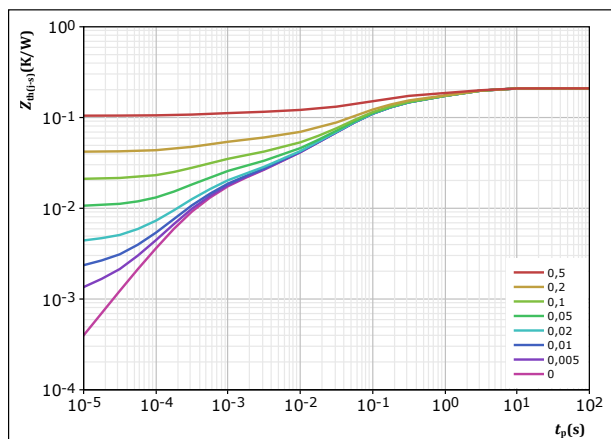

$D = t_p / T$
 $R_{th(j-s)} = 0,21 K/W$
IGBT thermal model values

R (K/W)	τ (s)
5,79E-02	1,97E+00
2,98E-02	3,38E-01
8,07E-02	7,73E-02
1,86E-02	1,74E-02
9,35E-03	2,43E-03
1,32E-02	3,85E-04



Inverter Switch Characteristics

figure 5. IGBT

Safe operating area

$I_C = f(V_{CE})$

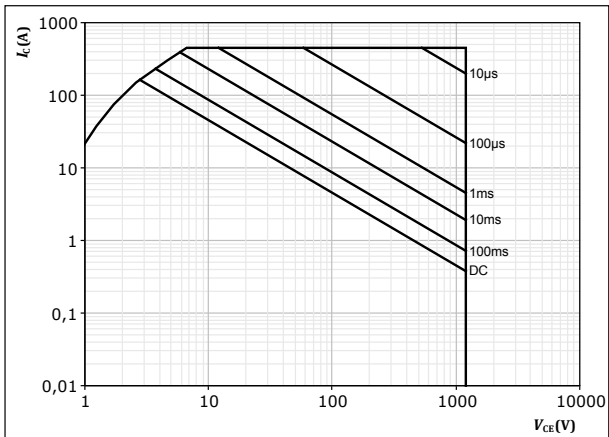

$D =$ single pulse
 $T_s = 80 \text{ } ^\circ\text{C}$
 $V_{CE} = 15 \text{ V}$
 $T_j = T_{jmax}$



Inverter Diode Characteristics

figure 6. FWD

Typical forward characteristics

$$I_F = f(V_F)$$

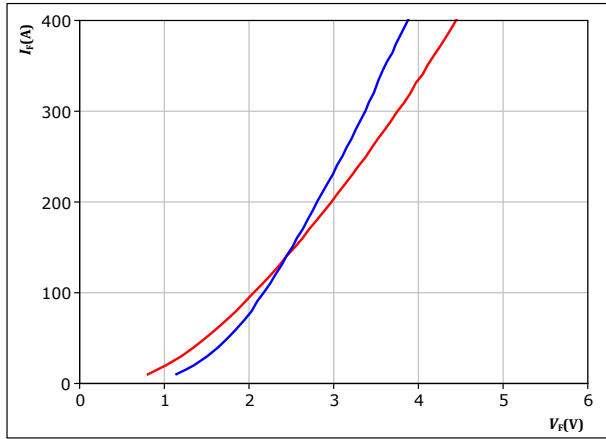

$t_p = 250 \mu s$
 T_j : — 25 °C
 — 150 °C

figure 7. FWD

Transient thermal impedance as a function of pulse width

$$Z_{th(j-s)} = f(t_p)$$

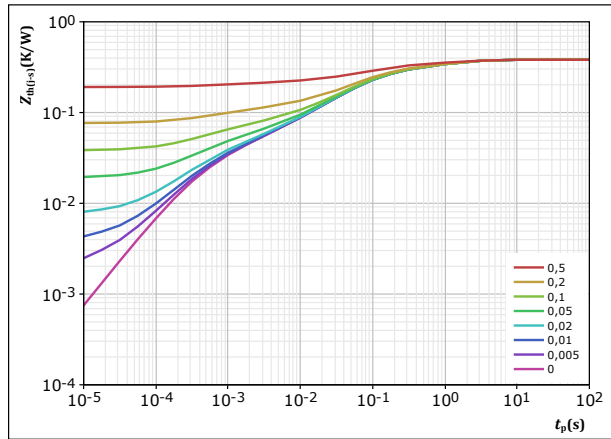

$D = t_p / T$
 $R_{th(j-s)} = 0,382 \text{ K/W}$
 FWD thermal model values

$R \text{ (K/W)}$	$\tau \text{ (s)}$
6,91E-02	1,62E+00
6,99E-02	3,07E-01
1,62E-01	6,80E-02
3,85E-02	1,30E-02
2,21E-02	1,79E-03
2,04E-02	3,53E-04



Thermistor Characteristics

figure 8. Thermistor

Typical PTC characteristic as function of temperature

$$R_T = f(T)$$

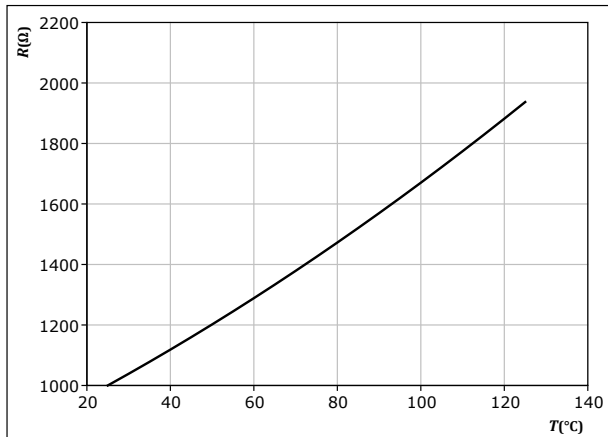



Inverter Switching Characteristics

figure 9. IGBT

Typical switching energy losses as a function of collector current
 $E = f(I_c)$

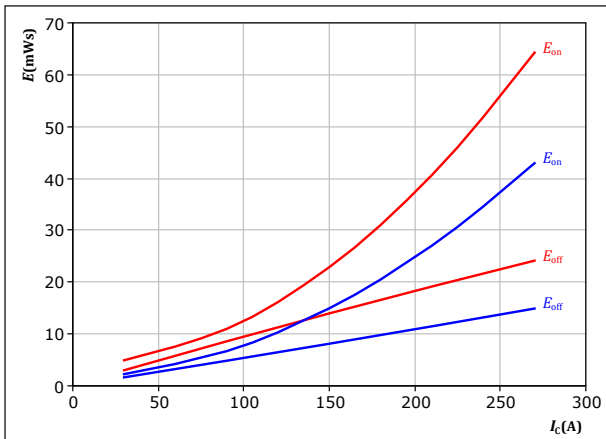

With an inductive load at

$V_{CE} = 600$ V
 $V_{GE} = \pm 15$ V
 $R_{gon} = 2$ Ω
 $R_{goff} = 2$ Ω

T_j : — 25 °C
 — 150 °C

figure 10. IGBT

Typical switching energy losses as a function of gate resistor
 $E = f(R_g)$

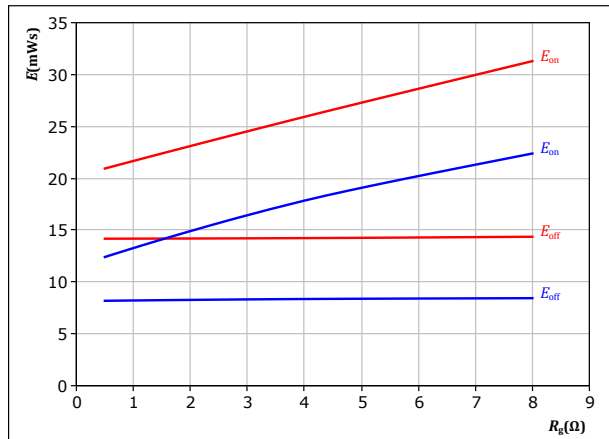

With an inductive load at

$V_{CE} = 600$ V
 $V_{GE} = \pm 15$ V
 $I_c = 150$ A

T_j : — 25 °C
 — 150 °C

figure 11. FWD

Typical reverse recovered energy loss as a function of collector current
 $E_{rec} = f(I_c)$

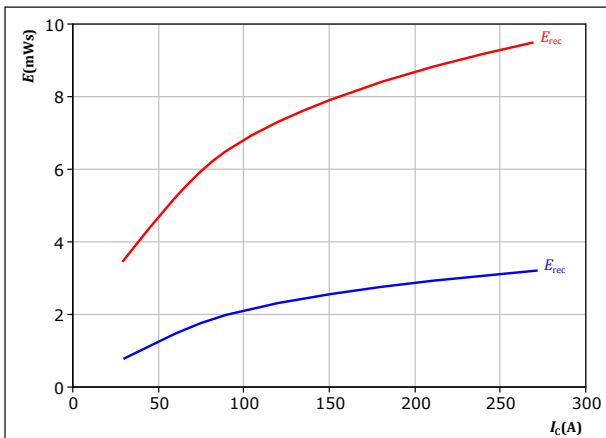

With an inductive load at

$V_{CE} = 600$ V
 $V_{GE} = \pm 15$ V
 $R_{gon} = 2$ Ω

T_j : — 25 °C
 — 150 °C

figure 12. FWD

Typical reverse recovered energy loss as a function of gate resistor
 $E_{rec} = f(R_g)$

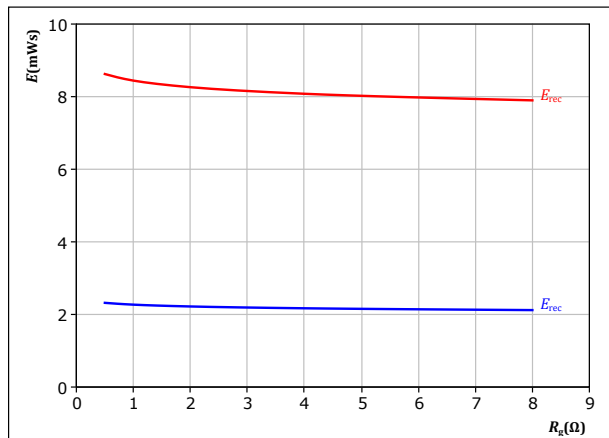

With an inductive load at

$V_{CE} = 600$ V
 $V_{GE} = \pm 15$ V
 $I_c = 150$ A

T_j : — 25 °C
 — 150 °C



Inverter Switching Characteristics

figure 13. IGBT

Typical switching times as a function of collector current
 $t = f(I_c)$

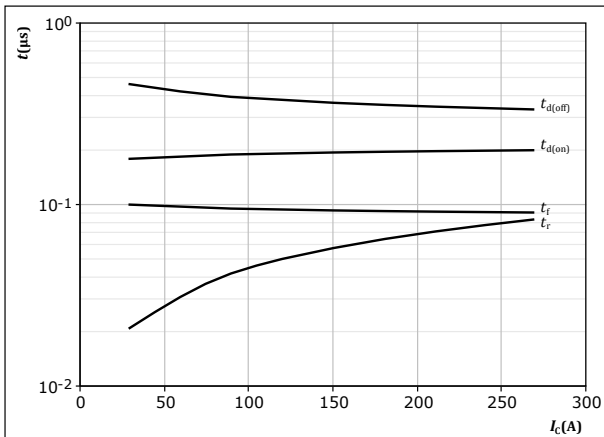

With an inductive load at
 $T_j = 150 \text{ }^\circ\text{C}$
 $V_{CE} = 600 \text{ V}$
 $V_{GE} = \pm 15 \text{ V}$
 $R_{gon} = 2 \text{ } \Omega$
 $R_{goff} = 2 \text{ } \Omega$

figure 14. IGBT

Typical switching times as a function of gate resistor
 $t = f(R_g)$

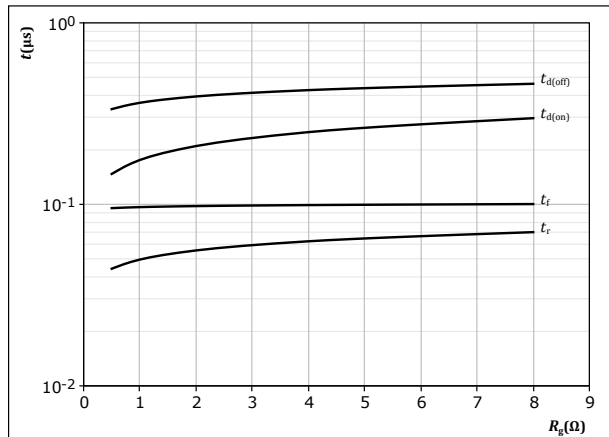

With an inductive load at
 $T_j = 150 \text{ }^\circ\text{C}$
 $V_{CE} = 600 \text{ V}$
 $V_{GE} = \pm 15 \text{ V}$
 $I_c = 150 \text{ A}$

figure 15. FWD

Typical reverse recovery time as a function of collector current
 $t_{rr} = f(I_c)$

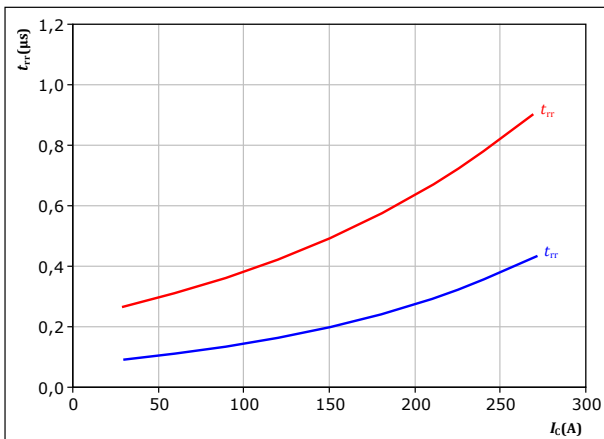

With an inductive load at
 $V_{CE} = 600 \text{ V}$
 $V_{GE} = \pm 15 \text{ V}$
 $R_{gon} = 2 \text{ } \Omega$
 $T_j: \text{ — } 25 \text{ }^\circ\text{C}$
 $\text{ — } 150 \text{ }^\circ\text{C}$

figure 16. FWD

Typical reverse recovery time as a function of IGBT turn on gate resistor
 $t_{rr} = f(R_{gon})$

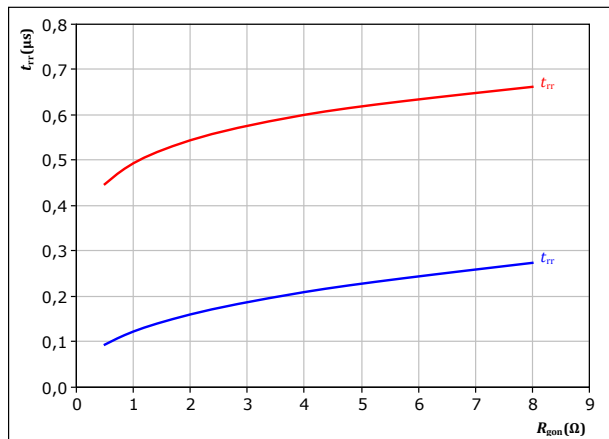

With an inductive load at
 $V_{CE} = 600 \text{ V}$
 $V_{GE} = \pm 15 \text{ V}$
 $I_c = 150 \text{ A}$
 $T_j: \text{ — } 25 \text{ }^\circ\text{C}$
 $\text{ — } 150 \text{ }^\circ\text{C}$



Inverter Switching Characteristics

figure 17. FWD

Typical recovered charge as a function of collector current

$$Q_r = f(I_c)$$

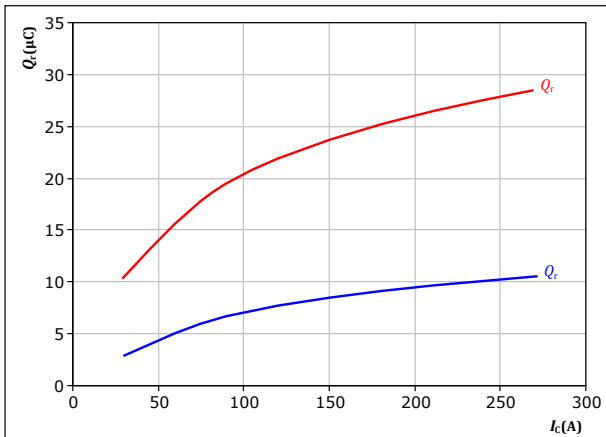

With an inductive load at

$V_{CE} = 600$ V
 $V_{GE} = \pm 15$ V
 $R_{gon} = 2$ Ω

T_j : — 25 °C
— 150 °C

figure 18. FWD

Typical recovered charge as a function of turn on gate resistor

$$Q_r = f(R_{gon})$$

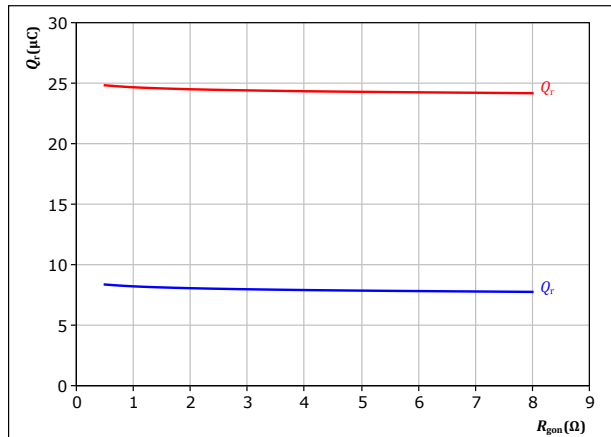

With an inductive load at

$V_{CE} = 600$ V
 $V_{GE} = \pm 15$ V
 $I_c = 150$ A

T_j : — 25 °C
— 150 °C

figure 19. FWD

Typical peak reverse recovery current as a function of collector current

$$I_{RM} = f(I_c)$$

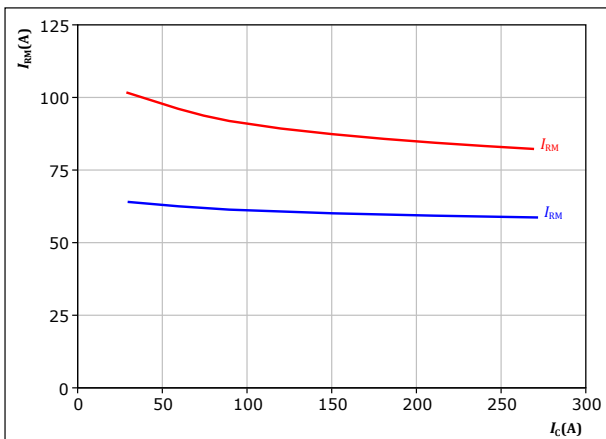

With an inductive load at

$V_{CE} = 600$ V
 $V_{GE} = \pm 15$ V
 $R_{gon} = 2$ Ω

T_j : — 25 °C
— 150 °C

figure 20. FWD

Typical peak reverse recovery current as a function of turn on gate resistor

$$I_{RM} = f(R_{gon})$$

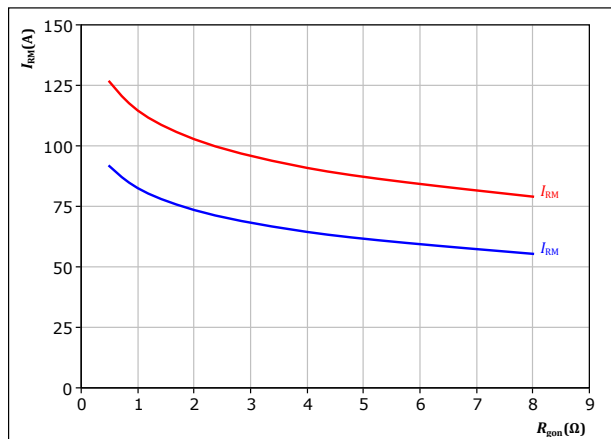

With an inductive load at

$V_{CE} = 600$ V
 $V_{GE} = \pm 15$ V
 $I_c = 150$ A

T_j : — 25 °C
— 150 °C



Inverter Switching Characteristics

figure 21. FWD

Typical rate of fall of forward and reverse recovery current as a function of collector current
 $di_f/dt, di_r/dt = f(I_c)$

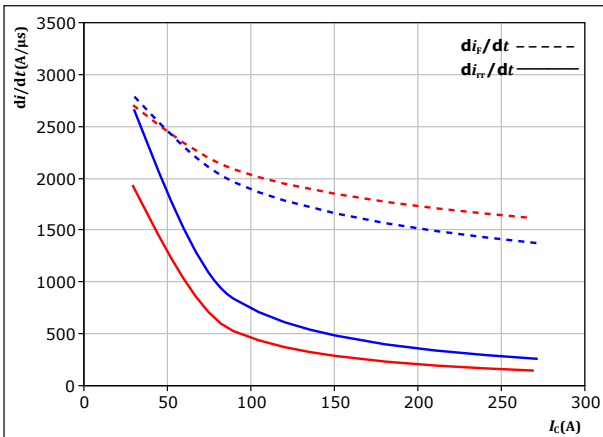

With an inductive load at

$V_{CE} = 600 \text{ V}$
 $V_{GE} = \pm 15 \text{ V}$
 $R_{gon} = 2 \ \Omega$

T_j : — 25 °C
 — 150 °C

figure 22. FWD

Typical rate of fall of forward and reverse recovery current as a function of turn on gate resistor
 $di_f/dt, di_r/dt = f(R_{gon})$

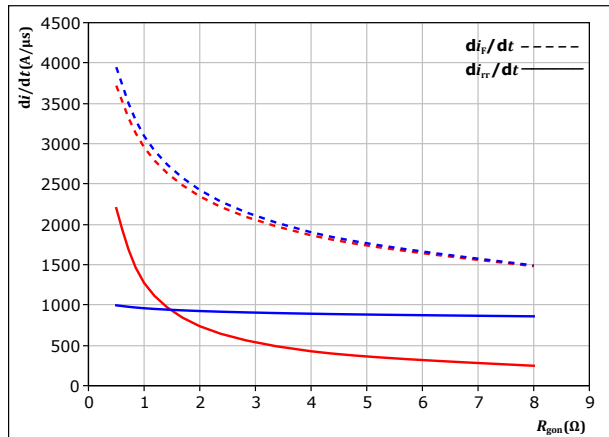

With an inductive load at

$V_{CE} = 600 \text{ V}$
 $V_{GE} = \pm 15 \text{ V}$
 $I_c = 150 \text{ A}$

T_j : — 25 °C
 — 150 °C

figure 23. IGBT

Reverse bias safe operating area

$I_c = f(V_{CE})$

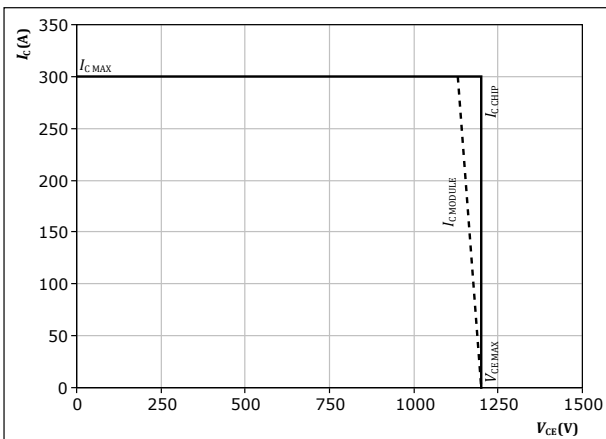

At $T_j = 150 \text{ °C}$
 $R_{gon} = 2 \ \Omega$
 $R_{goff} = 2 \ \Omega$



Inverter Switching Definitions

figure 24. IGBT
Turn-off Switching Waveforms & definition of t_{doff} , t_{Eoff} (t_{Eoff} = integrating time for E_{off})

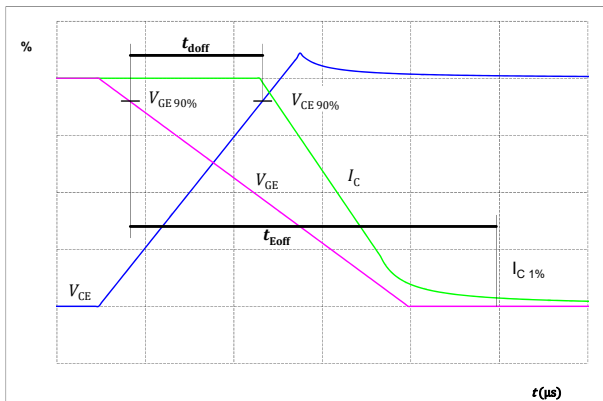

figure 25. IGBT
Turn-on Switching Waveforms & definition of t_{don} , t_{Eon} (t_{Eon} = integrating time for E_{on})

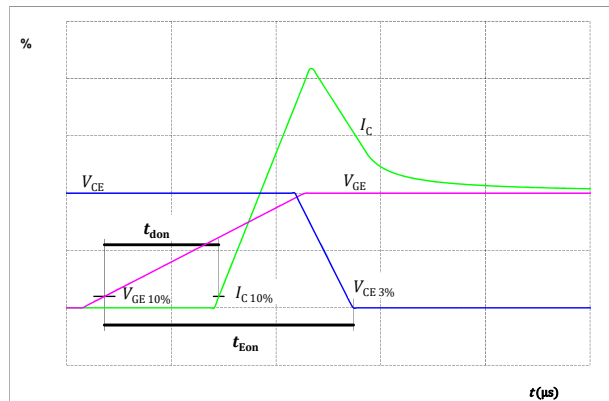

figure 26. IGBT
Turn-off Switching Waveforms & definition of t_f

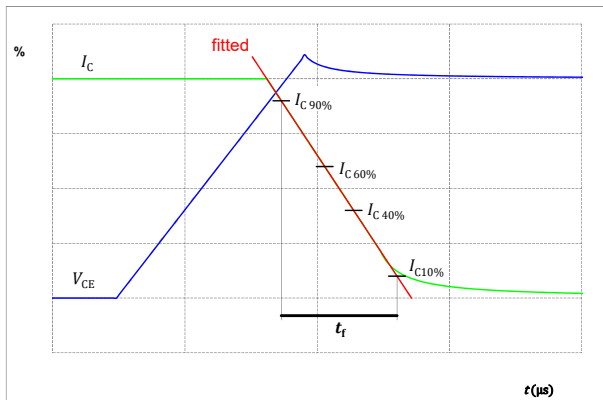
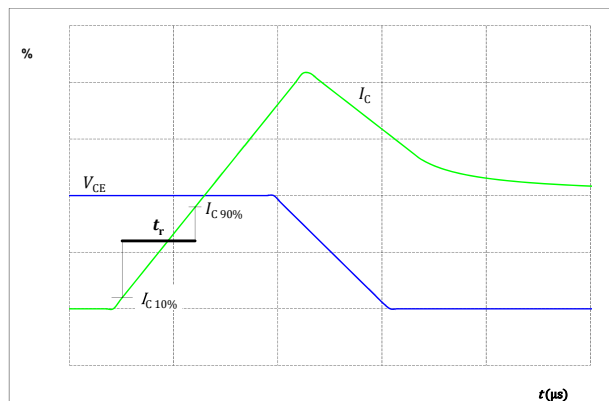

figure 27. IGBT
Turn-on Switching Waveforms & definition of t_r





Inverter Switching Definitions

figure 28. FWD

Turn-off Switching Waveforms & definition of t_{rr}

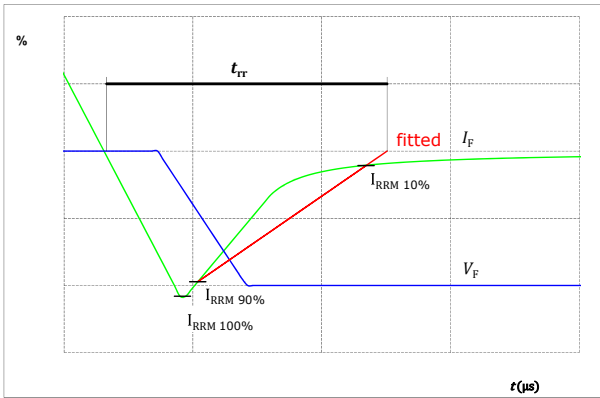
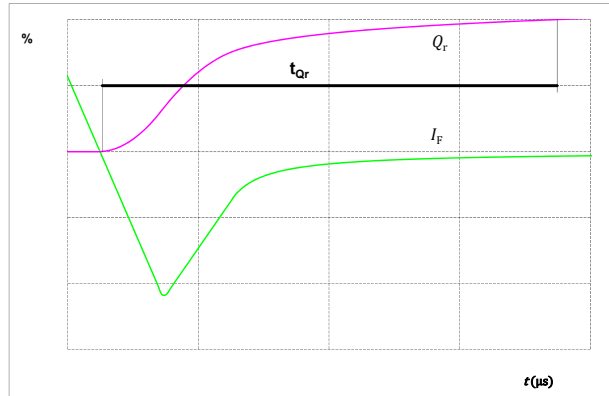



figure 29. FWD

Turn-on Switching Waveforms & definition of t_{Qr} (t_{Qr} = integrating time for Q_r)





Ordering Code	
Version	Ordering Code
With std lid (6.5mm height) + no thermal grease	V23990-K430-F40-/0A/-PM
With thin lid (2.8mm height) + no thermal grease	V23990-K430-F40-/0B/-PM/
With std lid (6.5mm height) + thermal grease (0,8 W/mK, P12, silicone-based)	V23990-K430-F40-/1A/-PM
With thin lid (2.8mm height) + thermal grease (0,8 W/mK, P12, silicone-based)	V23990-K430-F40-/1B/-PM
With std lid (6.5mm height) + thermal grease (2,5 W/mK, TG20032, silicone-free)	V23990-K430-F40-/4A/-PM
With thin lid (2.8mm height) + thermal grease (2,5 W/mK, TG20032, silicone-free)	V23990-K430-F40-/4B/-PM
With std lid (6.5mm height) + thermal grease (2,5 W/mK, HPTP, silicone-based)	V23990-K430-F40-/5A/-PM
With thin lid (2.8mm height) + thermal grease (2,5 W/mK, HPTP, silicone-based)	V23990-K430-F40-/5B/-PM

Marking						
Text	VIN	Date code	Name&Ver	UL	Lot	Serial
	VIN	WWYY	NNNNNNVV	UL	LLLLL	SSSS
	Type&Ver	Lot number	Serial	Date code		
	TTTTTTVV	LLLLL	SSSS	WWYY		

Outline								
Pin table [mm]								
Pin	X	Y	Function					
1	15,83	-25,3	G5	45	not assembled			
2	15,83	-6,4	E5	46	not assembled			
3				47	not assembled			
4				48	not assembled			
5				49	not assembled			
6	15,83	6,4	-T	50	-35,68	22,1	-DC	
7	15,83	15,7	+T	51	-35,68	25,3	-DC	
8				52	-36,58	-25,3	+DC	
9				53	not assembled			
10				54	-36,58	-15,7	U	
11				55	-36,58	-12,5	U	
12				56	-36,58	-9,3	U	
13				57	-36,58	-6,1	U	
14	8,13	25,3	G6	58	not assembled			
15	1,82	-15,38	W	59	-39,32	18,9	E2	
16	1,82	-12,18	W	60	-39,32	22,1	-DC	
17	1,82	-8,98	W	61	-39,32	25,3	-DC	
18	1,82	-5,79	W	62	-40,22	-25,3	+DC	
19				63	not assembled			
20				64	-40,22	-15,7	U	
21				65	-40,22	-12,5	U	
22	-1,82	-15,38	W	66	-40,22	-9,3	U	
23	-1,82	-12,18	W	67	-40,22	-6,09	U	
24	-1,82	-8,98	W	68	-50,18	-25,3	+DC	
25	-1,82	-5,79	W	69	-50,18	-22,1	+DC	
26				70	-50,18	-18,9	+DC	
27				71	not assembled			
28	-7,27	22,1	E6	72	not assembled			
29	-7,27	25,3	G4	73	not assembled			
30				74	not assembled			
31	-16,05	-15,02	V	75	not assembled			
32	-16,05	-11,82	V	76	-50,18	22,1	-DC	
33	-16,05	-8,63	V	77	-50,18	25,3	-DC	
34	-16,05	-5,42	V	78	-53,82	-25,3	+DC	
35				79	-53,82	-22,1	+DC	
36	-19,7	-15,02	V	80	-53,82	-18,9	+DC	
37	-19,7	-11,82	V	81	not assembled			
38	-19,7	-8,62	V	82	not assembled			
39	-19,7	-5,42	V	83	not assembled			
40	-22,26	-1	G3	84	-53,82	3,1	G1	
41	-22,26	2,2	E3	85	-53,82	6,3	E1	
42	-22,67	22,1	E4	86	not assembled			
43	-22,67	25,3	G2	87	-53,82	22,1	-DC	
44				88	-53,82	25,3	-DC	

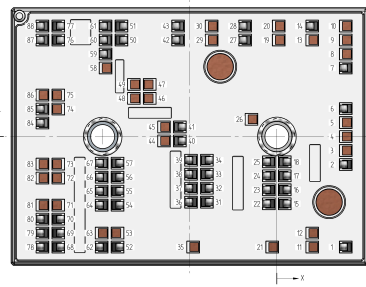

Pad positions refers to center point. For more informations on pad design please see package data



Vincotech

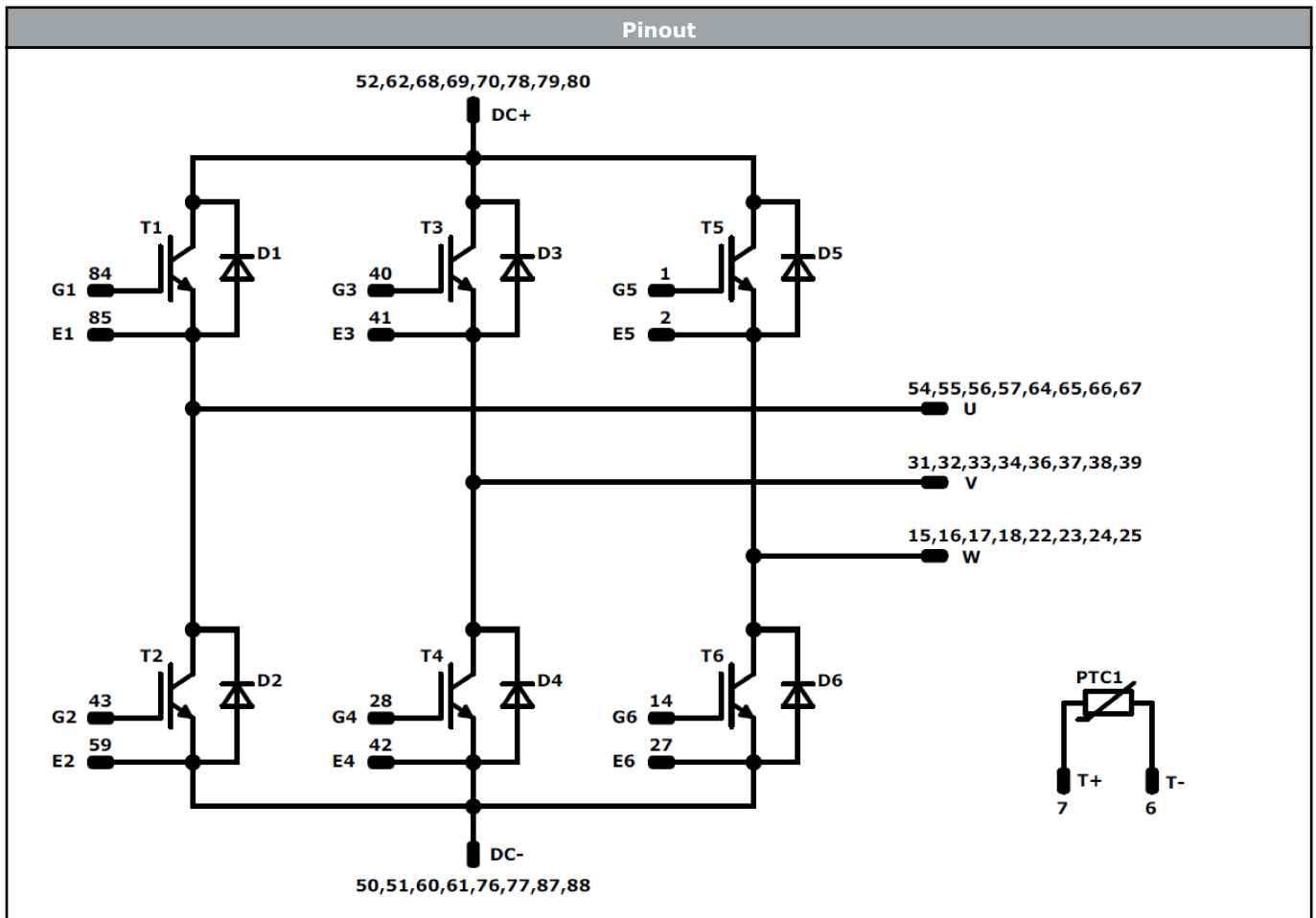

Identification					
ID	Component	Voltage	Current	Function	Comment
T2, T1, T4, T3, T6, T5	IGBT	1200 V	150 A	Inverter Switch	
D1, D2, D3, D4, D5, D6	FWD	1200 V	150 A	Inverter Diode	
PTC1	PTC			Thermistor	



Packaging instruction				
Standard packaging quantity (SPQ) 48	>SPQ	Standard	<SPQ	Sample

Handling instruction
Handling instructions for MiniSKiiP® 3 packages see vincotech.com website.

Package data
Package data for MiniSKiiP® 3 packages see vincotech.com website.

Vincotech thermistor reference
See Vincotech thermistor reference table at vincotech.com website.

UL recognition and file number
This device is certified according to UL 1557 standard, UL file number E192116. For more information see vincotech.com website. 

Document No.:	Date:	Modification:	Pages
V23990-K430-F40-/1A/-PM-D5-14	15 Sep. 2020	Update datasheet format Correct R-tau values of Inverter Switch and Diode Correct Typical forward characteristics of Inverter Diode	

DISCLAIMER

The information, specifications, procedures, methods and recommendations herein (together "information") are presented by Vincotech to reader in good faith, are believed to be accurate and reliable, but may well be incomplete and/or not applicable to all conditions or situations that may exist or occur. Vincotech reserves the right to make any changes without further notice to any products to improve reliability, function or design. No representation, guarantee or warranty is made to reader as to the accuracy, reliability or completeness of said information or that the application or use of any of the same will avoid hazards, accidents, losses, damages or injury of any kind to persons or property or that the same will not infringe third parties rights or give desired results. It is reader's sole responsibility to test and determine the suitability of the information and the product for reader's intended use.

LIFE SUPPORT POLICY

Vincotech products are not authorised for use as critical components in life support devices or systems without the express written approval of Vincotech.

As used herein:

1. Life support devices or systems are devices or systems which, (a) are intended for surgical implant into the body, or (b) support or sustain life, or (c) whose failure to perform when properly used in accordance with instructions for use provided in labelling can be reasonably expected to result in significant injury to the user.
2. A critical component is any component of a life support device or system whose failure to perform can be reasonably expected to cause the failure of the life support device or system, or to affect its safety or effectiveness.