

T1,T2,T3,T4,T5,T6/D1,D2,D3,D4,D5,D6

Figure 21 T1,T2,T3,T4,T5,T6 IGBT

Power dissipation as a function of heatsink temperature

$P_{tot} = f(T_h)$

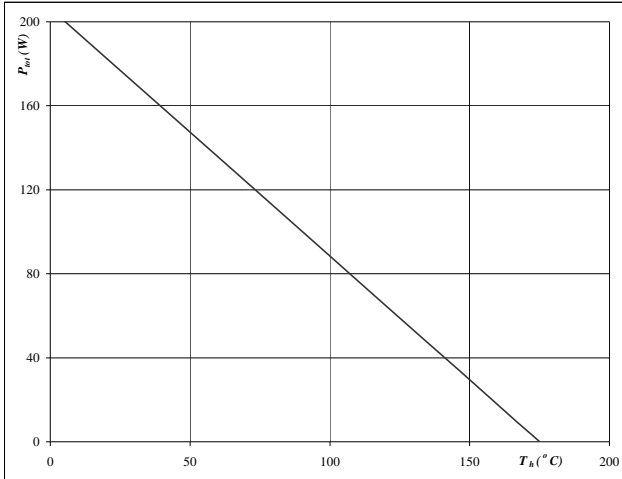

At
 $T_j = 175 \text{ } ^\circ\text{C}$

Figure 22 T1,T2,T3,T4,T5,T6 IGBT

Collector current as a function of heatsink temperature

$I_C = f(T_h)$

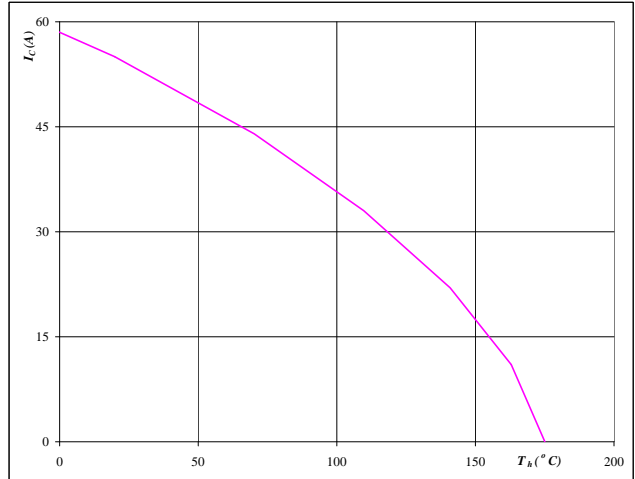

At
 $T_j = 175 \text{ } ^\circ\text{C}$
 $V_{GE} = 15 \text{ V}$

Figure 23 D1,D2,D3,D4,D5,D6 FWD

Power dissipation as a function of heatsink temperature

$P_{tot} = f(T_h)$

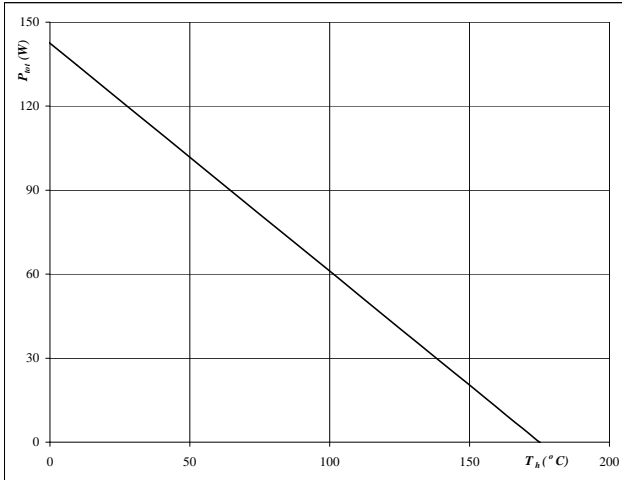

At
 $T_j = 175 \text{ } ^\circ\text{C}$

Figure 24 D1,D2,D3,D4,D5,D6 FWD

Forward current as a function of heatsink temperature

$I_F = f(T_h)$

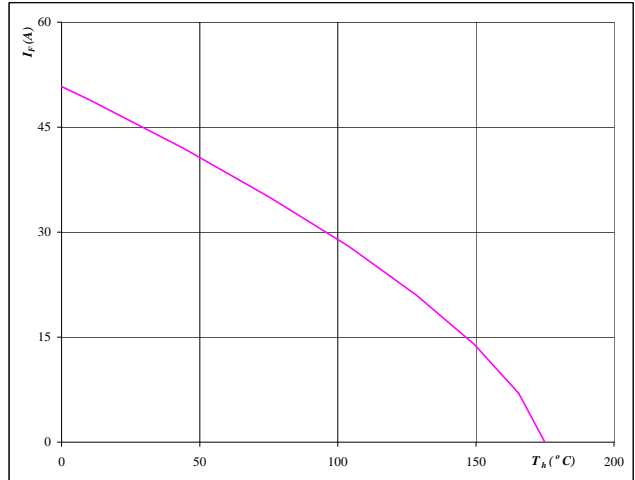

At
 $T_j = 175 \text{ } ^\circ\text{C}$

T1,T2,T3,T4,T5,T6/D1,D2,D3,D4,D5,D6
Figure 25 T1,T2,T3,T4,T5,T6 IGBT

Safe operating area as a function of collector-emitter voltage

$I_C = f(V_{CE})$

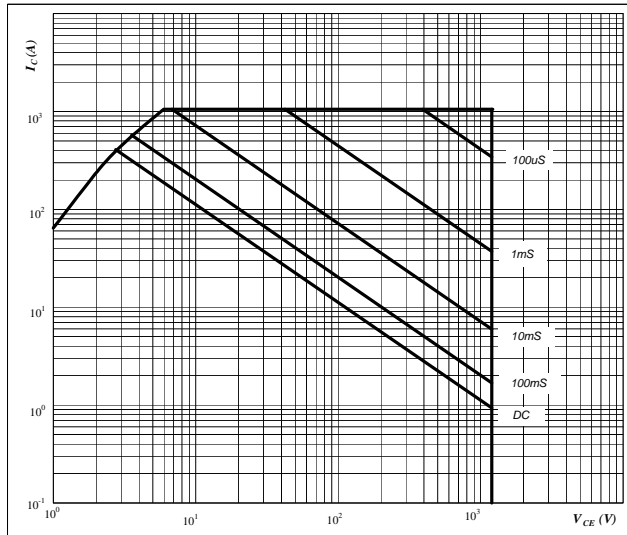

At
 D = single pulse
 $T_h = 80$ °C
 $V_{GE} = \pm 15$ V
 $T_j = T_{jmax}$ °C

Figure 26 T1,T2,T3,T4,T5,T6 IGBT

Gate voltage vs Gate charge

$V_{GE} = f(Q_{GE})$

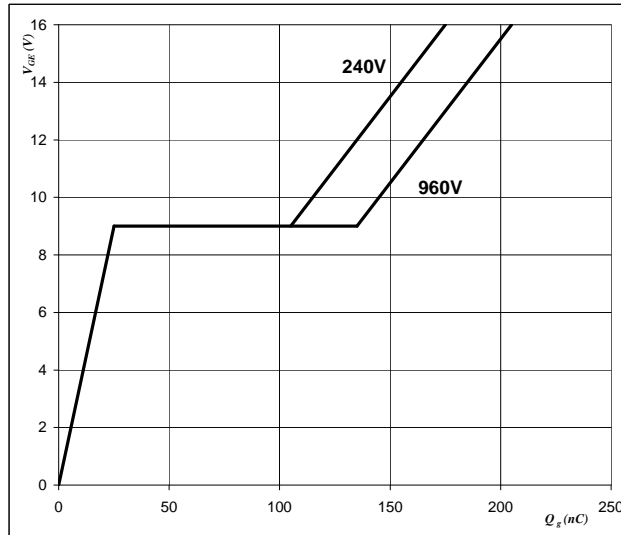

At
 $I_C = 35$ A

Thermistor
Figure 1 Thermistor

Typical PTC characteristic as a function of temperature

$R_T = f(T)$

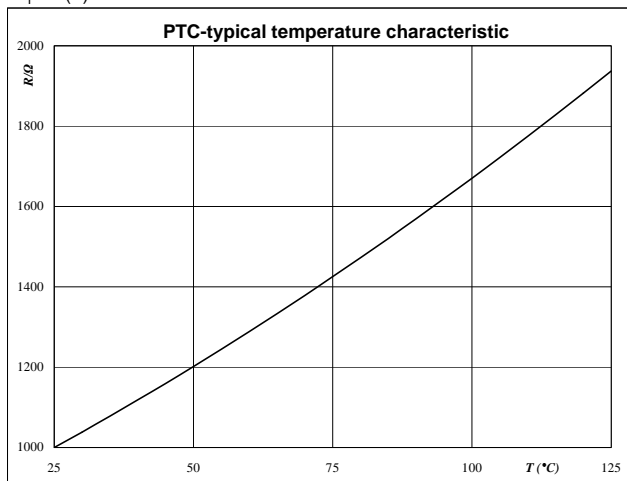

Switching Definitions Output Inverter

General conditions

T_j	=	150 °C
R_{gon}	=	16 Ω
R_{goff}	=	16 Ω

Figure 1 Output inverter IGBT

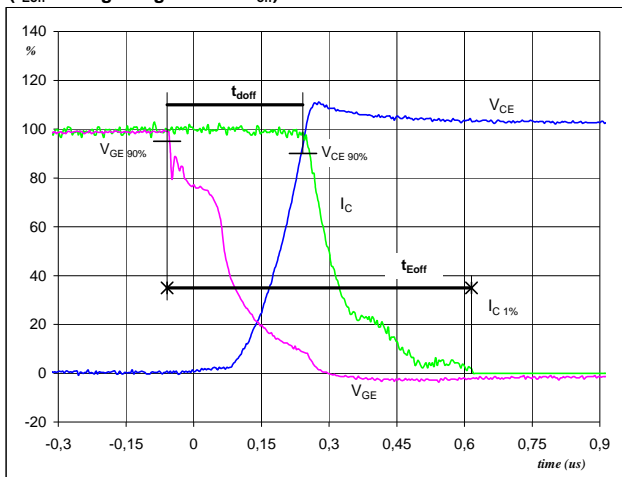
Turn-off Switching Waveforms & definition of t_{doff} , t_{Eoff}
(t_{Eoff} = integrating time for E_{off})

$V_{GE}(0\%) =$	-15	V
$V_{GE}(100\%) =$	15	V
$V_C(100\%) =$	600	V
$I_C(100\%) =$	35	A
$t_{doff} =$	0,29	μs
$t_{Eoff} =$	0,67	μs

Figure 2 Output inverter IGBT

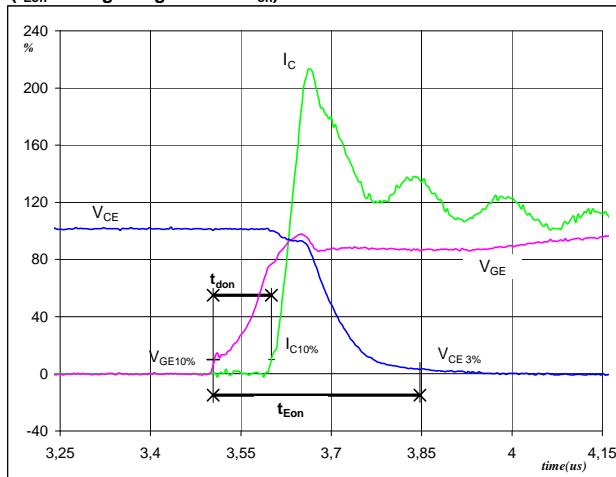
Turn-on Switching Waveforms & definition of t_{don} , t_{Eon}
(t_{Eon} = integrating time for E_{on})

$V_{GE}(0\%) =$	-15	V
$V_{GE}(100\%) =$	15	V
$V_C(100\%) =$	600	V
$I_C(100\%) =$	35	A
$t_{don} =$	0,10	μs
$t_{Eon} =$	0,34	μs

Figure 3 Output inverter IGBT

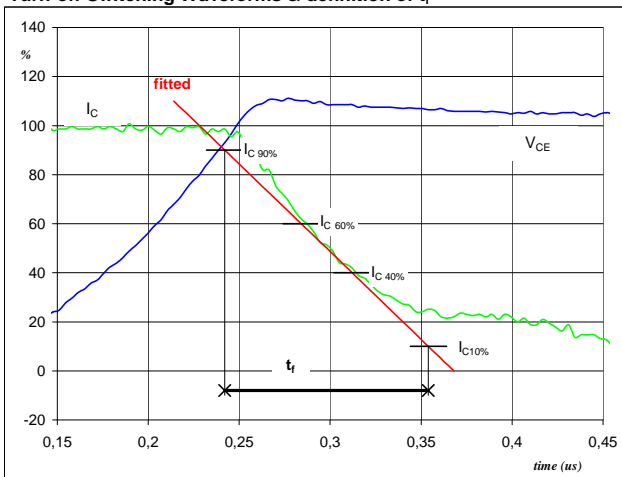
Turn-off Switching Waveforms & definition of t_f

$V_C(100\%) =$	600	V
$I_C(100\%) =$	35	A
$t_f =$	0,11	μs

Figure 4 Output inverter IGBT

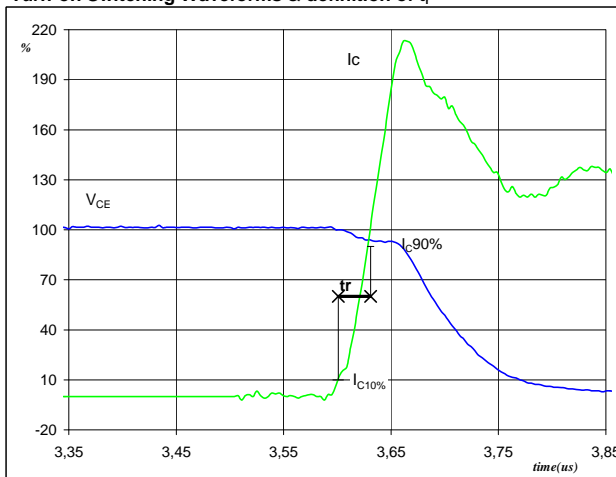
Turn-on Switching Waveforms & definition of t_r

$V_C(100\%) =$	600	V
$I_C(100\%) =$	35	A
$t_r =$	0,03	μs

Switching Definitions Output Inverter

Figure 5 Output inverter IGBT

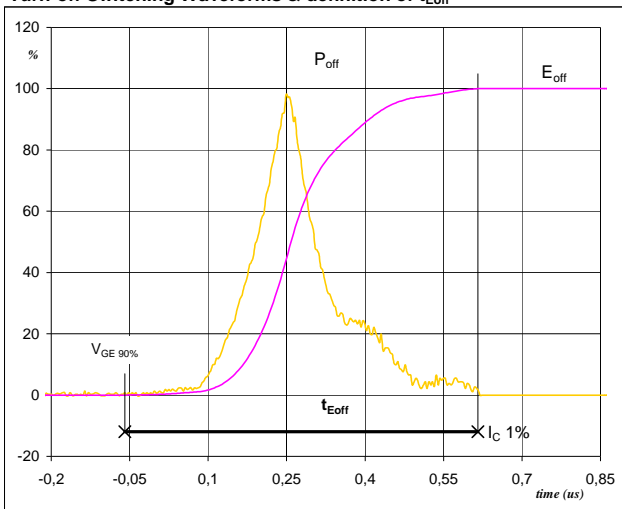
Turn-off Switching Waveforms & definition of t_{Eoff}

P_{off} (100%) =	21,03	kW
E_{off} (100%) =	3,28	mJ
t_{Eoff} =	0,67	μ s

Figure 6 Output inverter IGBT

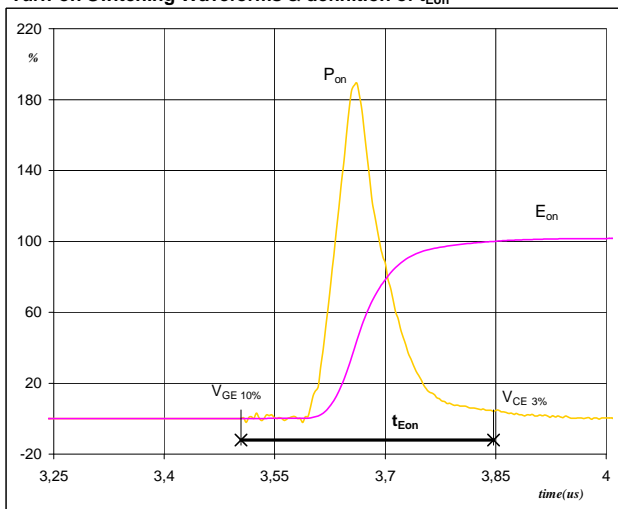
Turn-on Switching Waveforms & definition of t_{Eon}

P_{on} (100%) =	21,03	kW
E_{on} (100%) =	3,07	mJ
t_{Eon} =	0,34	μ s

Figure 7 Output inverter IGBT

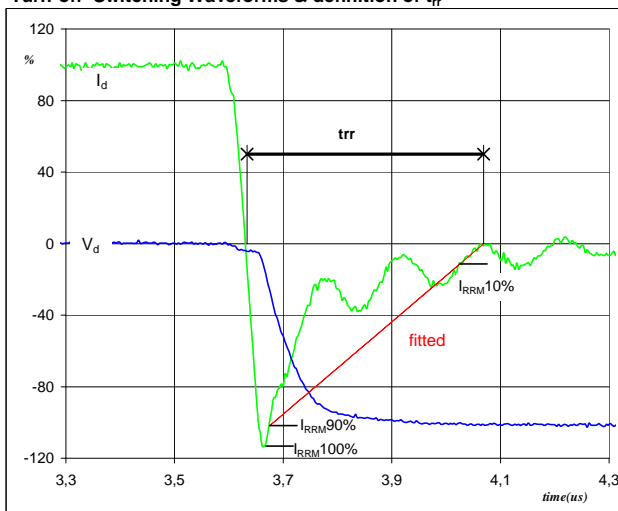
Turn-off Switching Waveforms & definition of t_{rr}

V_d (100%) =	600	V
I_d (100%) =	35	A
I_{RRM} (100%) =	-40	A
t_{rr} =	0,29	μ s

Switching Definitions Output Inverter

Figure 8 Output inverter FWD

Turn-on Switching Waveforms & definition of t_{Qrr}
 (t_{Qrr} = integrating time for Q_{rr})

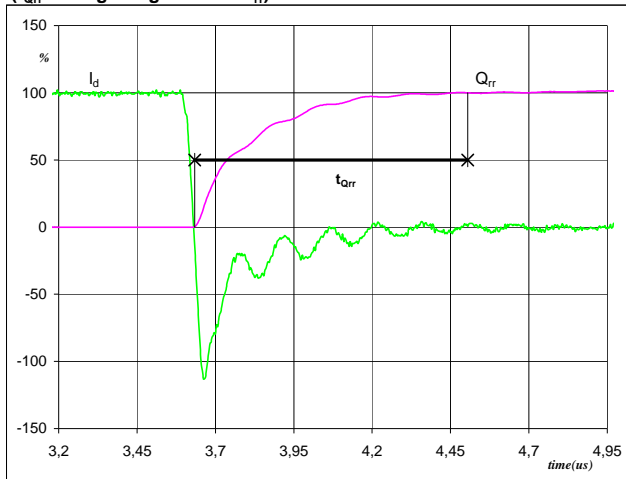

I_d (100%) =	35	A
Q_{rr} (100%) =	5,34	μC
t_{Qrr} =	0,87	μs

Figure 9 Output inverter FWD

Turn-on Switching Waveforms & definition of t_{Erec}
 (t_{Erec} = integrating time for E_{rec})

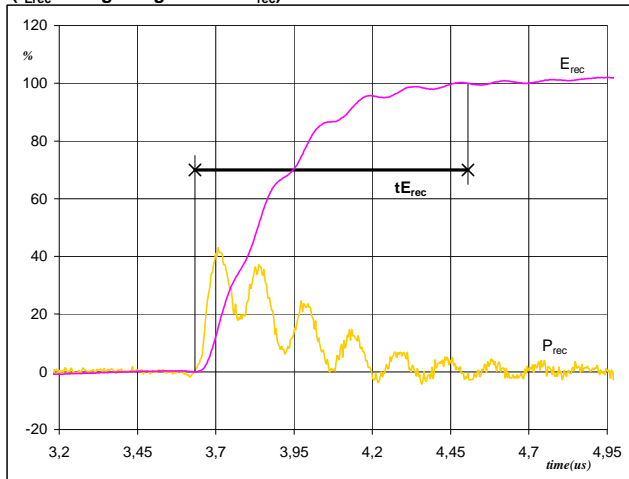

P_{rec} (100%) =	21,03	kW
E_{rec} (100%) =	2,07	mJ
t_{Erec} =	0,87	μs

Ordering Code and Marking - Outline - Pinout
Ordering Code & Marking

Version	Ordering Code	in DataMatrix as	in packaging barcode as
with std lid (black V23990-K22-T-PM)	V23990-K238-F40-/0A/-PM	K238F40	K238F40-/0A/
with std lid (black V23990-K22-T-PM) and P12	V23990-K238-F40-/1A/-PM	K238F40	K238F40-/1A/
with thin lid (white V23990-K23-T-PM)	V23990-K238-F40-/0B/-PM	K238F40	K238F40-/0B/
with thin lid (white V23990-K23-T-PM) and P12	V23990-K238-F40-/1B/-PM	K238F40	K238F40-/1B/

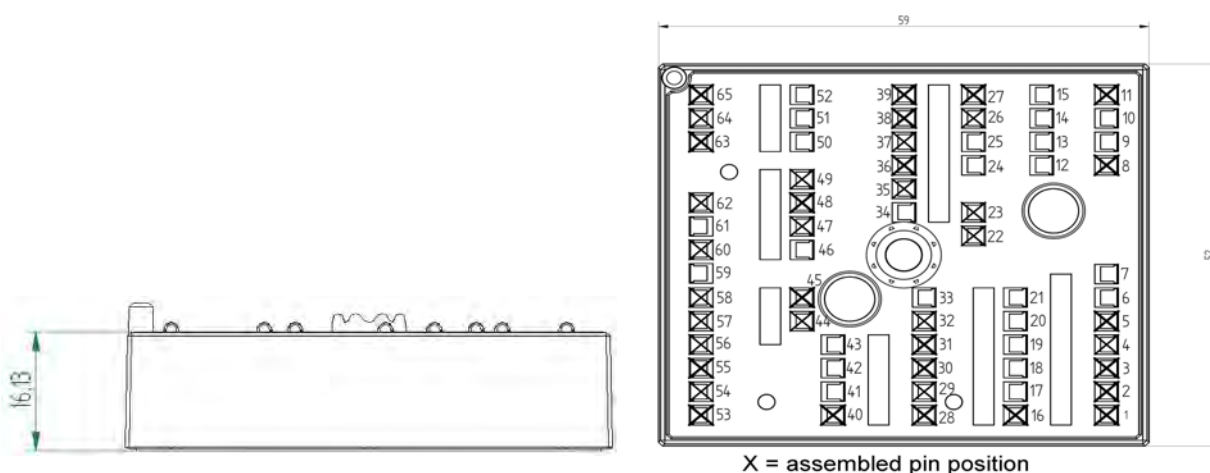
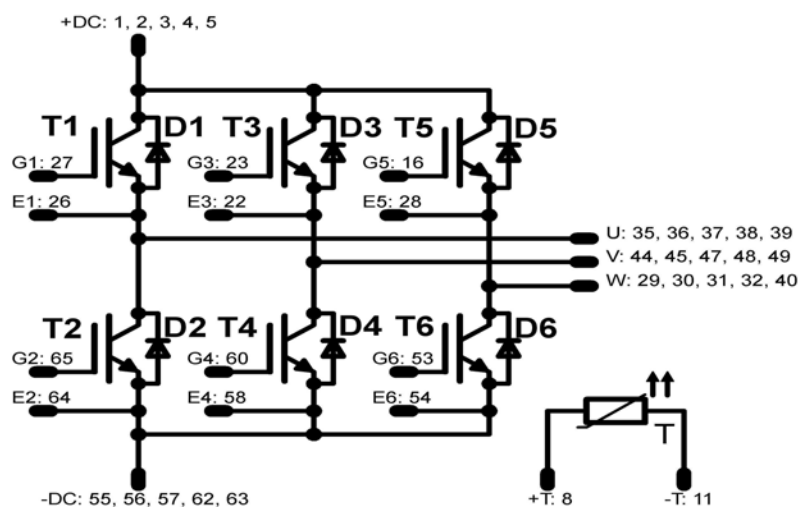
Outline

Pinout

DISCLAIMER

The information given in this datasheet describes the type of component and does not represent assured characteristics. For tested values please contact Vincotech. Vincotech reserves the right to make changes without further notice to any products herein to improve reliability, function or design. Vincotech does not assume any liability arising out of the application or use of any product or circuit described herein; neither does it convey any license under its patent rights, nor the rights of others.

LIFE SUPPORT POLICY

Vincotech products are not authorised for use as critical components in life support devices or systems without the express written approval of Vincotech.

As used herein:

1. Life support devices or systems are devices or systems which, (a) are intended for surgical implant into the body, or (b) support or sustain life, or (c) whose failure to perform when properly used in accordance with instructions for use provided in labelling can be reasonably expected to result in significant injury to the user.
2. A critical component is any component of a life support device or system whose failure to perform can be reasonably expected to cause the failure of the life support device or system, or to affect its safety or effectiveness.