

MiniSKiiP® 1 PACK	1200V/15A
<div style="border: 1px solid black; padding: 5px; margin-bottom: 5px;"> <p style="text-align: center; background-color: #000080; color: white; margin: 0;">Features</p> <ul style="list-style-type: none"> Solderless interconnection Trench Fieldstop IGBT4 technology </div> <div style="border: 1px solid black; padding: 5px; margin-bottom: 5px;"> <p style="text-align: center; background-color: #000080; color: white; margin: 0;">Target Applications</p> <ul style="list-style-type: none"> Servo Drives Industrial Motor Drives UPS </div> <div style="border: 1px solid black; padding: 5px;"> <p style="text-align: center; background-color: #000080; color: white; margin: 0;">Types</p> <ul style="list-style-type: none"> V23990-K219-F-PM </div>	<div style="border: 1px solid black; padding: 5px; margin-bottom: 5px;"> <p style="text-align: center; background-color: #000080; color: white; margin: 0;">MiniSKiiP® 1 housing</p> </div> <div style="border: 1px solid black; padding: 5px;"> <p style="text-align: center; background-color: #000080; color: white; margin: 0;">Schematic</p> </div>

Maximum Ratings

$T_j=25^{\circ}\text{C}$, unless otherwise specified

Parameter	Symbol	Condition	Value	Unit
T1, T2, T3, T4, T5, T6				
Collector-emitter break down voltage	V_{CE}		1200	V
DC collector current	I_C	$T_j=T_{j,max}$ $T_n=80^{\circ}\text{C}$	24	A
Repetitive peak collector current	$I_{C,pulse}$	t_p limited by $T_{j,max}$	45	A
Turn off safe operating area		$V_{CE} \leq 1200\text{V}$, $T_j \leq T_{op,max}$	45	A
Power dissipation per IGBT	P_{tot}	$T_j=T_{j,max}$ $T_h=80^{\circ}\text{C}$	61	W
Gate-emitter peak voltage	V_{GE}		± 20	V
Short circuit ratings	t_{SC}	$T_j \leq 150^{\circ}\text{C}$	10	μs
	V_{CC}	$V_{GE}=15\text{V}$	900	V
Maximum Junction Temperature	$T_{j,max}$		150	$^{\circ}\text{C}$

D1, D2, D3, D4, D5, D6

Peak Repetitive Reverse Voltage	V_{RRM}		1200	V
DC forward current	I_F	$T_j=T_{j,max}$ $T_n=80^{\circ}\text{C}$	19	A
Repetitive peak forward current	I_{FRM}	t_p limited by $T_{j,max}$	45	A
Power dissipation per Diode	P_{tot}	$T_j=T_{j,max}$ $T_n=80^{\circ}\text{C}$	36	W
Maximum Junction Temperature	$T_{j,max}$		150	$^{\circ}\text{C}$

Maximum Ratings

$T_j=25^{\circ}\text{C}$, unless otherwise specified

Parameter	Symbol	Condition	Value	Unit
-----------	--------	-----------	-------	------

Thermal Properties

Storage temperature	T_{stg}		-40...+125	°C
Operation temperature under switching condition	T_{op}		-40...+(T_{jmax} - 25)	°C

Insulation Properties

Insulation voltage	V_{is}	t=2s DC voltage	4000	V
Creepage distance			min 12,7	mm
Clearance			min 12,7	mm

Characteristic Values

Parameter	Symbol	Conditions					Value			Unit
		$V_{GE}[V]$ or $V_{GS}[V]$	$V_r[V]$ or $V_{CE}[V]$ or $V_{DS}[V]$	$I_c[A]$ or $I_F[A]$ or $I_b[A]$	T_j	Min	Typ	Max		
T1,T2,T3,T4,T5,T6										
Gate emitter threshold voltage	$V_{GE(th)}$	$V_{CE}=V_{GE}$			0,0006	$T_j=25^{\circ}C$ $T_j=125^{\circ}C$	5	5,8	6,5	V
Collector-emitter saturation voltage	$V_{CE(sat)}$		15		15	$T_j=25^{\circ}C$ $T_j=125^{\circ}C$	1,35	1,66 1,84	2,15	V
Collector-emitter cut-off current incl. diode	I_{CES}		0	1200		$T_j=25^{\circ}C$ $T_j=125^{\circ}C$			0,1	mA
Gate-emitter leakage current	I_{GES}		± 20	0		$T_j=25^{\circ}C$ $T_j=125^{\circ}C$			180	nA
Integrated Gate resistor	R_{gint}							-		Ω
Turn-on delay time	$t_{d(on)}$	$R_{goff}=36 \Omega$ $R_{gon}=36 \Omega$	± 15	300	50	$T_j=25^{\circ}C$		42		ns
Rise time	t_r					$T_j=125^{\circ}C$		40		
Turn-off delay time	$t_{d(off)}$					$T_j=25^{\circ}C$		18		
Fall time	t_f					$T_j=125^{\circ}C$		24		
Turn-on energy loss per pulse	E_{on}					$T_j=25^{\circ}C$		365		
Turn-off energy loss per pulse	E_{off}					$T_j=125^{\circ}C$		442		
Input capacitance	C_{ies}									
Output capacitance	C_{oss}	$f=1MHz$	0	25		$T_j=25^{\circ}C$		0,1		
Reverse transfer capacitance	C_{rss}					$T_j=25^{\circ}C$		0,1		
Gate charge	Q_{Gate}		± 15			$T_j=25^{\circ}C$		108		nC
Thermal resistance chip to heatsink per chip	R_{thJH}	Thermal grease thickness $\leq 50\mu m$ $\lambda=1W/mK$						1,15		K/W
D1,D2,D3,D4,D5,D6										
Diode forward voltage	V_F				15	$T_j=25^{\circ}C$ $T_j=125^{\circ}C$		1,61 1,64	1,8 1,8	V
Peak reverse recovery current	I_{RRM}					$T_j=25^{\circ}C$ $T_j=125^{\circ}C$		16 19		A
Reverse recovery time	t_{rr}					$T_j=25^{\circ}C$ $T_j=125^{\circ}C$		397 559		ns
Reverse recovered charge	Q_{rr}	$di/dt=tbd A/us$	15	600	15	$T_j=25^{\circ}C$ $T_j=125^{\circ}C$		2,11 3,42		μC
Peak rate of fall of recovery current	$di(rec)max/dt$					$T_j=25^{\circ}C$ $T_j=125^{\circ}C$		245 170		A/ μs
Reverse recovered energy	E_{rec}					$T_j=25^{\circ}C$ $T_j=125^{\circ}C$		0,81 1,38		mWs
Thermal resistance chip to heatsink per chip	R_{thJH}	Thermal grease thickness $\leq 50\mu m$ $\lambda=1W/mK$						1,95		K/W
Thermistor										
Rated resistance	R					$T=25^{\circ}C$		1000		Ω
Deviation of R100	$\Delta R/R$	$R_{100}=1670 \Omega$				$T=100^{\circ}C$	-3		3	%
R100	R					$T=100^{\circ}C$		1670,313		Ω
A-value	B(25/50)	Tol. %				$T=25^{\circ}C$		$7,635 \cdot 10^{-3}$		1/K
B-value	B(25/100)	Tol. %				$T=25^{\circ}C$		$1,731 \cdot 10^{-5}$		1/K ²
Vincotech NTC Reference									E	

T1,T2,T3,T4,T5,T6 / D1,D2,D3,D4,D5,D6

Figure 1 T1,T2,T3,T4,T5,T6 IGBT

Typical output characteristics

$I_C = f(V_{CE})$

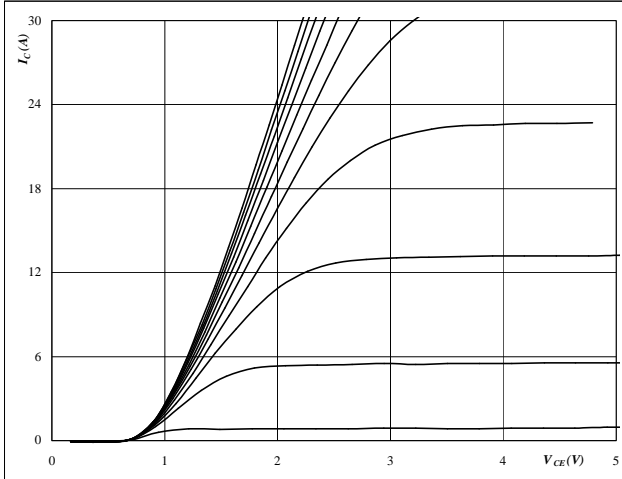

At
 $t_p = 250 \mu s$
 $T_j = 25 \text{ }^\circ C$
 V_{GE} from 7 V to 17 V in steps of 1 V

Figure 2 T1,T2,T3,T4,T5,T6 IGBT

Typical output characteristics

$I_C = f(V_{CE})$

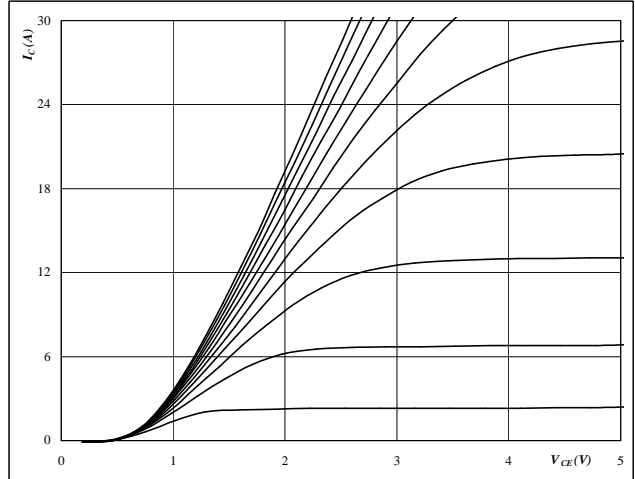

At
 $t_p = 250 \mu s$
 $T_j = 125 \text{ }^\circ C$
 V_{GE} from 7 V to 17 V in steps of 1 V

Figure 3 T1,T2,T3,T4,T5,T6 IGBT

Typical transfer characteristics

$I_C = f(V_{GE})$

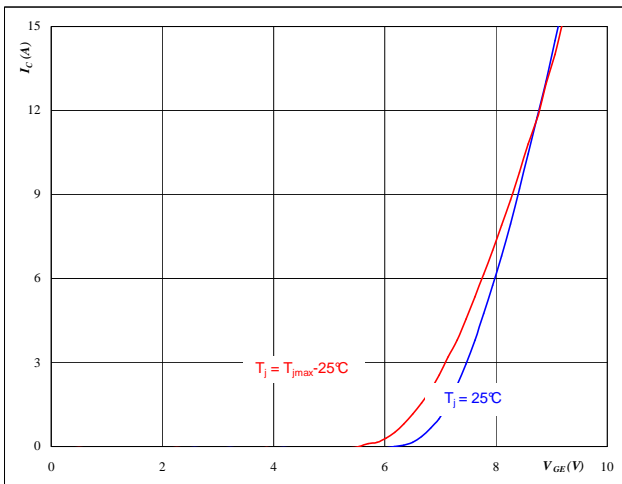

At
 $t_p = 250 \mu s$
 $V_{CE} = 10 V$

Figure 4 D1,D2,D3,D4,D5,D6 FWD

Typical diode forward current as a function of forward voltage

$I_F = f(V_F)$

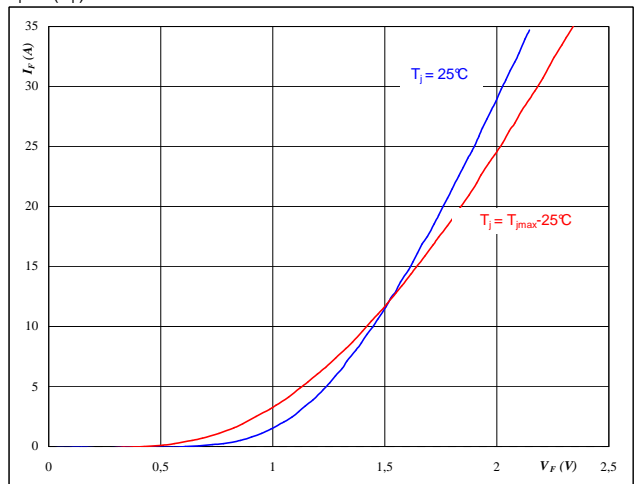

At
 $t_p = 250 \mu s$

T1,T2,T3,T4,T5,T6 / D1,D2,D3,D4,D5,D6

Figure 5 T1,T2,T3,T4,T5,T6 IGBT

Typical switching energy losses as a function of collector current

$E = f(I_C)$

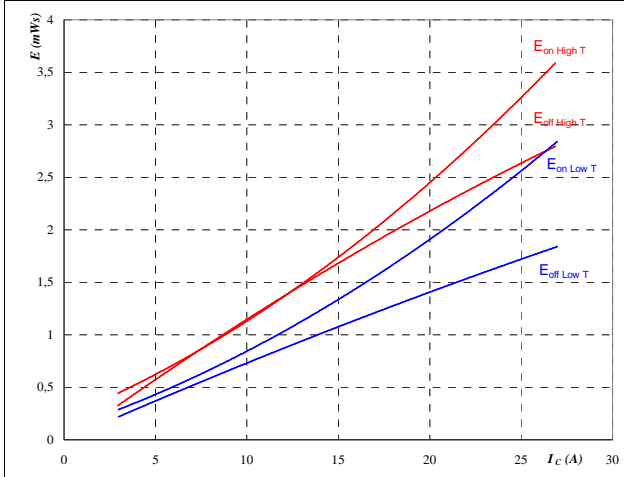

With an inductive load at

- T_J = 25/125 °C
- V_{CE} = 600 V
- V_{GE} = ±15 V
- R_{gon} = 54 Ω
- R_{goff} = 54 Ω

Figure 6 T1,T2,T3,T4,T5,T6 IGBT

Typical switching energy losses as a function of gate resistor

$E = f(R_G)$

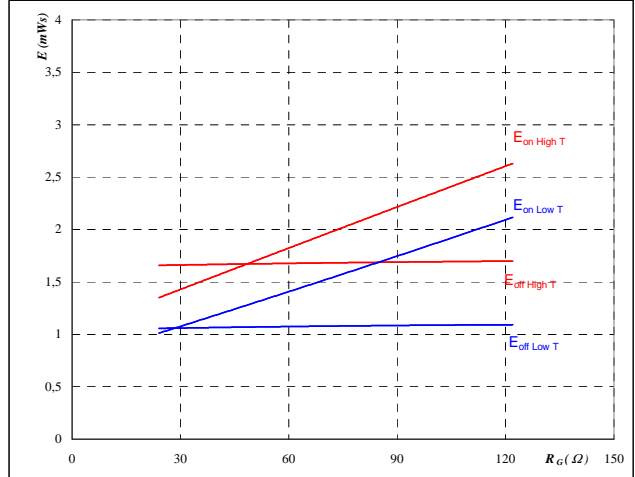

With an inductive load at

- T_J = 25/125 °C
- V_{CE} = 600 V
- V_{GE} = ±15 V
- I_C = 15 A

Figure 7 T1,T2,T3,T4,T5,T6 IGBT

Typical reverse recovery energy loss as a function of collector current

$E_{rec} = f(I_C)$

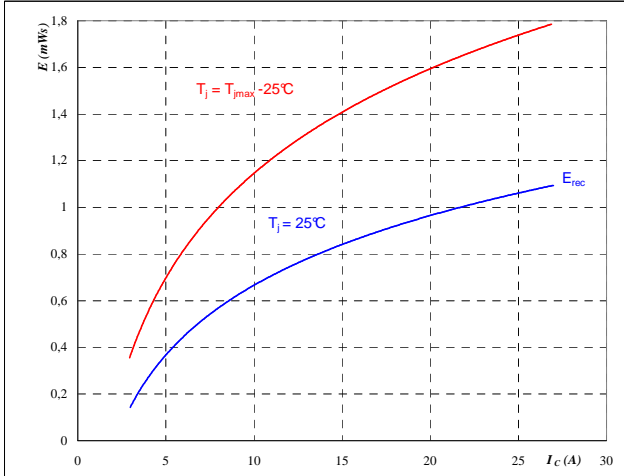

With an inductive load at

- T_J = 25/125 °C
- V_{CE} = 600 V
- V_{GE} = ±15 V
- R_{gon} = 54 Ω

Figure 8 T1,T2,T3,T4,T5,T6 IGBT

Typical reverse recovery energy loss as a function of gate resistor

$E_{rec} = f(R_G)$

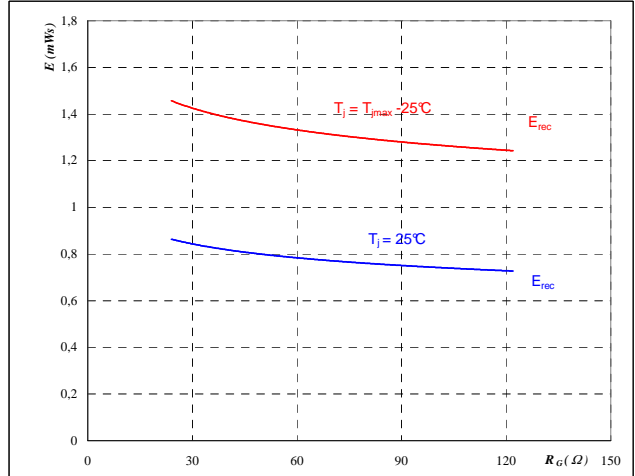

With an inductive load at

- T_J = 25/125 °C
- V_{CE} = 600 V
- V_{GE} = ±15 V
- I_C = 15 A

T1,T2,T3,T4,T5,T6 / D1,D2,D3,D4,D5,D6

Figure 9 T1,T2,T3,T4,T5,T6 IGBT

Typical switching times as a function of collector current

$t = f(I_C)$

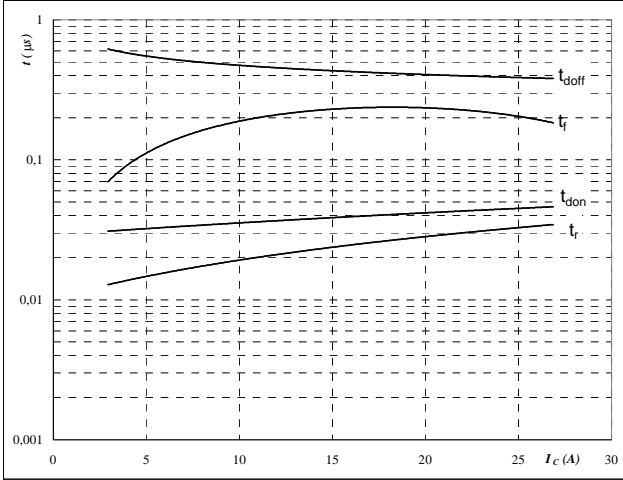

With an inductive load at

$T_J =$	125	°C
$V_{CE} =$	600	V
$V_{GE} =$	±15	V
$R_{gon} =$	54	Ω
$R_{goff} =$	54	Ω

Figure 10 T1,T2,T3,T4,T5,T6 IGBT

Typical switching times as a function of gate resistor

$t = f(R_G)$

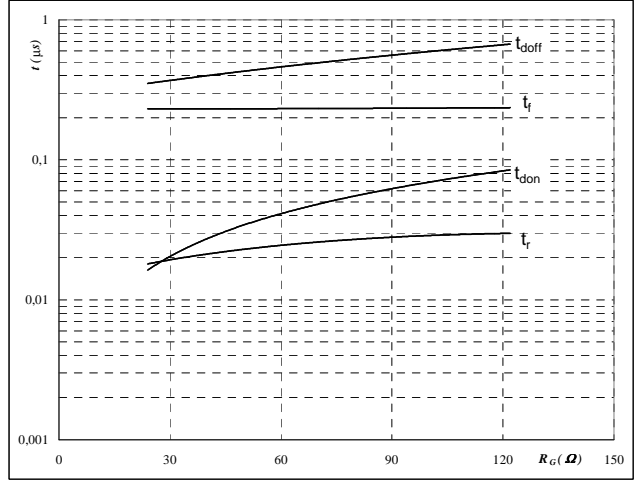

With an inductive load at

$T_J =$	125	°C
$V_{CE} =$	600	V
$V_{GE} =$	±15	V
$I_C =$	15	A

Figure 11 D1,D2,D3,D4,D5,D6 FWD

Typical reverse recovery time as a function of collector current

$t_{rr} = f(I_C)$

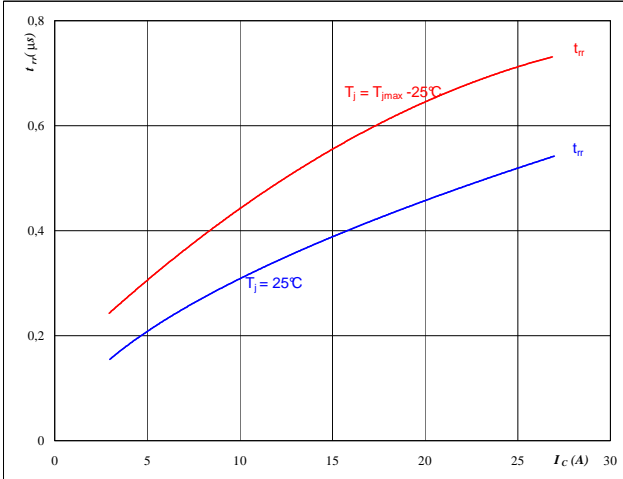

At

$T_J =$	25/125	°C
$V_{CE} =$	600	V
$V_{GE} =$	±15	V
$R_{gon} =$	54	Ω

Figure 12 D1,D2,D3,D4,D5,D6 FWD

Typical reverse recovery time as a function of IGBT turn on gate resistor

$t_{rr} = f(R_{gon})$

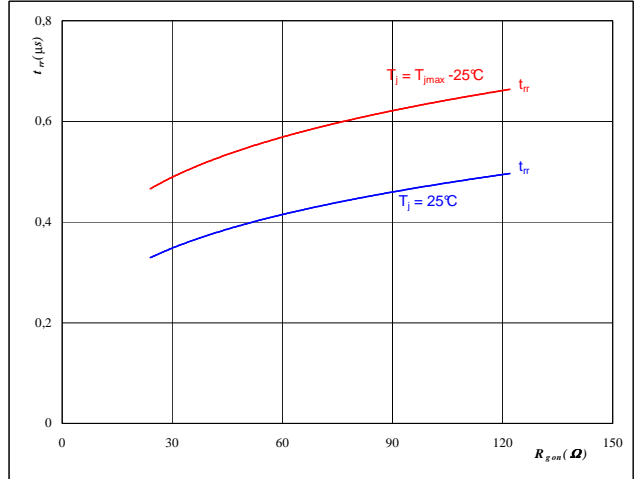

At

$T_J =$	25/125	°C
$V_R =$	600	V
$I_F =$	15	A
$V_{GE} =$	±15	V

T1,T2,T3,T4,T5,T6 / D1,D2,D3,D4,D5,D6

Figure 13 D1,D2,D3,D4,D5,D6 FWD

Typical reverse recovery charge as a function of collector current

$Q_{rr} = f(I_C)$

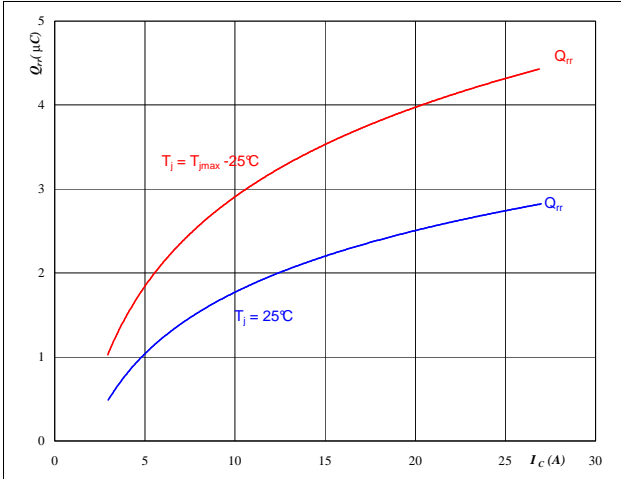

At

$T_j =$	25/125	$^\circ\text{C}$
$V_{CE} =$	600	V
$V_{GE} =$	± 15	V
$R_{gon} =$	54	Ω

Figure 14 D1,D2,D3,D4,D5,D6 FWD

Typical reverse recovery charge as a function of IGBT turn on gate resistor

$Q_{rr} = f(R_{gon})$

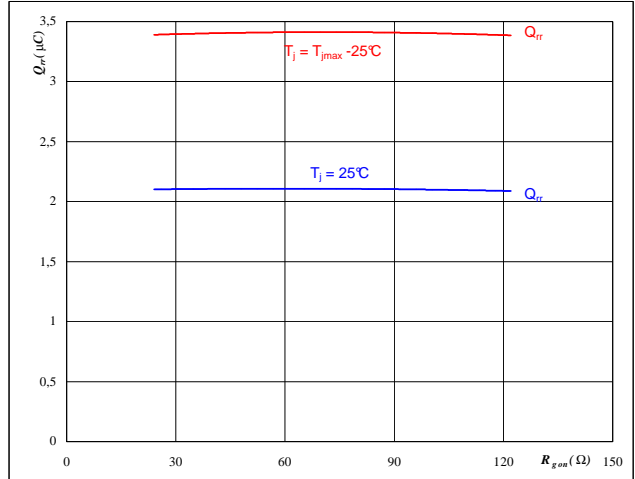

At

$T_j =$	25/125	$^\circ\text{C}$
$V_R =$	600	V
$I_F =$	15	A
$V_{GE} =$	± 15	V

Figure 15 D1,D2,D3,D4,D5,D6 FWD

Typical reverse recovery current as a function of collector current

$I_{RRM} = f(I_C)$

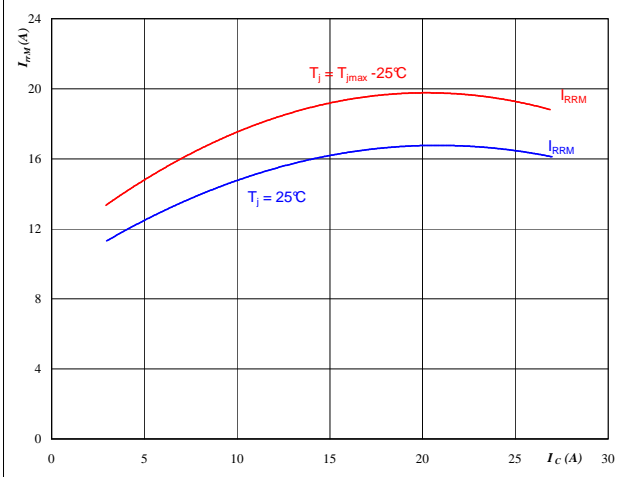

At

$T_j =$	25/125	$^\circ\text{C}$
$V_{CE} =$	600	V
$V_{GE} =$	± 15	V
$R_{gon} =$	54	Ω

Figure 16 D1,D2,D3,D4,D5,D6 FWD

Typical reverse recovery current as a function of IGBT turn on gate resistor

$I_{RRM} = f(R_{gon})$

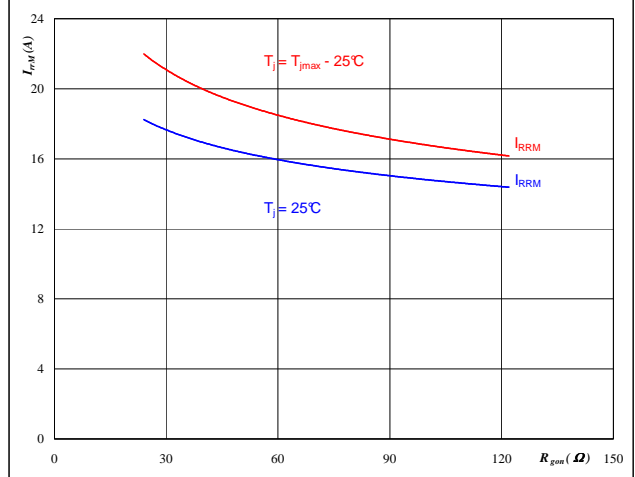

At

$T_j =$	25/125	$^\circ\text{C}$
$V_R =$	600	V
$I_F =$	15	A
$V_{GE} =$	± 15	V

T1,T2,T3,T4,T5,T6 / D1,D2,D3,D4,D5,D6

Figure 17 D1,D2,D3,D4,D5,D6 FWD

Typical rate of fall of forward and reverse recovery current as a function of collector current

$di_o/dt, di_{rec}/dt = f(I_c)$

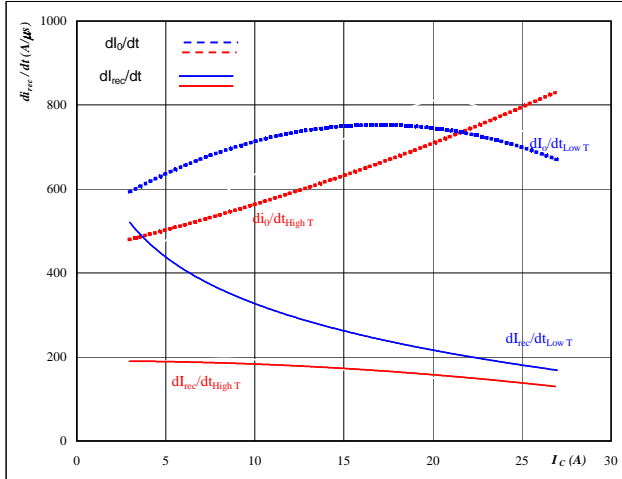

At
 $T_j = 25/125 \text{ } ^\circ\text{C}$
 $V_{CE} = 600 \text{ V}$
 $V_{GE} = \pm 15 \text{ V}$
 $R_{gon} = 54 \text{ } \Omega$

Figure 18 D1,D2,D3,D4,D5,D6 FWD

Typical rate of fall of forward and reverse recovery current as a function of IGBT turn on gate resistor

$di_o/dt, di_{rec}/dt = f(R_{gon})$

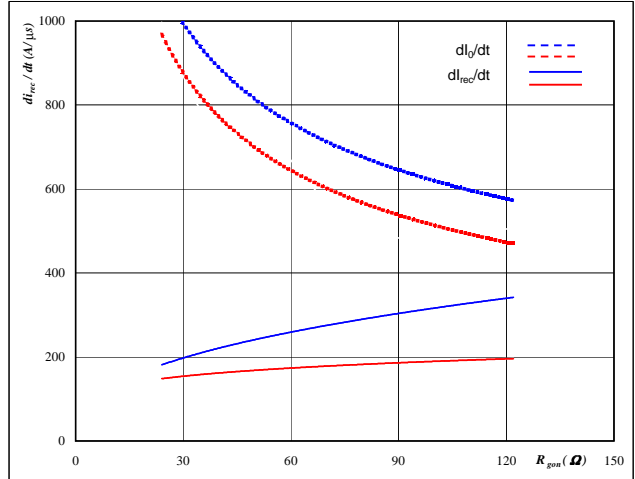

At
 $T_j = 25/125 \text{ } ^\circ\text{C}$
 $V_R = 600 \text{ V}$
 $I_F = 15 \text{ A}$
 $V_{GE} = \pm 15 \text{ V}$

Figure 19 T1,T2,T3,T4,T5,T6 IGBT

IGBT transient thermal impedance as a function of pulse width

$Z_{thJH} = f(t_p)$

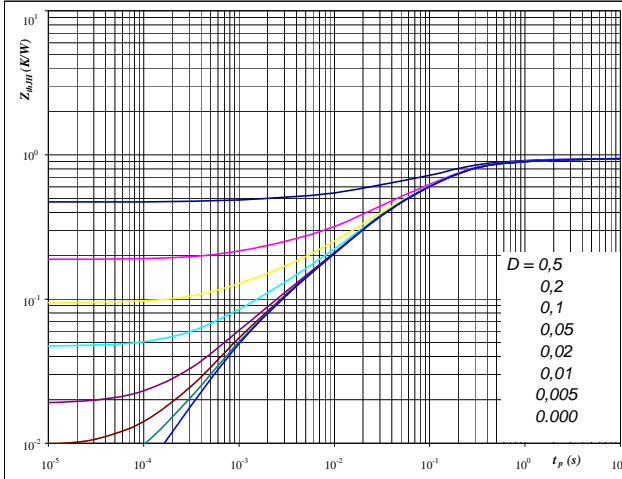

At
 $D = t_p / T$
 $R_{thJH} = 1,15 \text{ K/W}$

IGBT thermal model values

R (C/W)	Tau (s)
0,04	3,0E+00
0,14	4,6E-01
0,51	1,0E-01
0,20	1,4E-02
0,05	1,2E-03

Figure 20 D1,D2,D3,D4,D5,D6 FWD

FWD transient thermal impedance as a function of pulse width

$Z_{thJH} = f(t_p)$

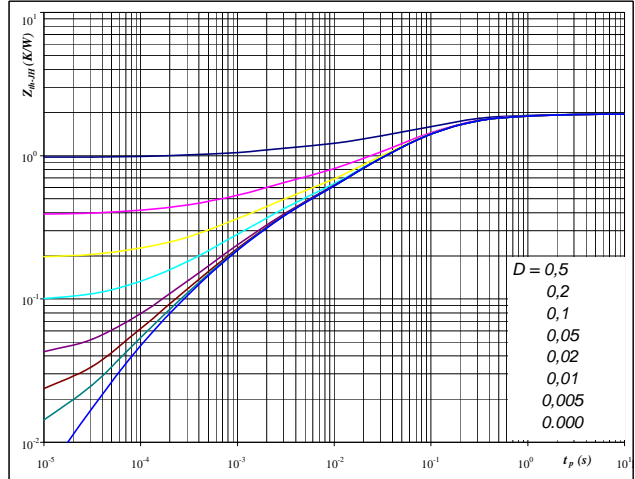

At
 $D = t_p / T$
 $R_{thJH} = 1,95 \text{ K/W}$

FWD thermal model values

R (C/W)	Tau (s)
0,09	9,5E-02
0,32	3,2E-01
0,88	8,9E-01
0,37	3,7E-01
0,22	2,3E-01
0,04	4,4E-02

T1,T2,T3,T4,T5,T6 / D1,D2,D3,D4,D5,D6

Figure 21 T1,T2,T3,T4,T5,T6 IGBT

Power dissipation as a function of heatsink temperature

$P_{tot} = f(T_h)$

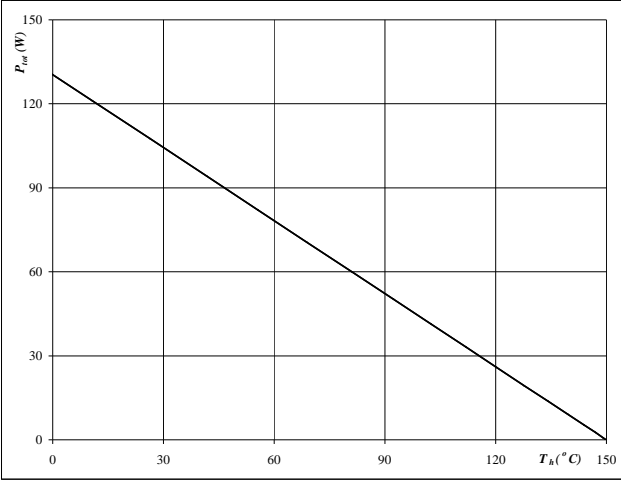

At
 $T_j = 150$ °C

Figure 22 T1,T2,T3,T4,T5,T6 IGBT

Collector current as a function of heatsink temperature

$I_C = f(T_h)$

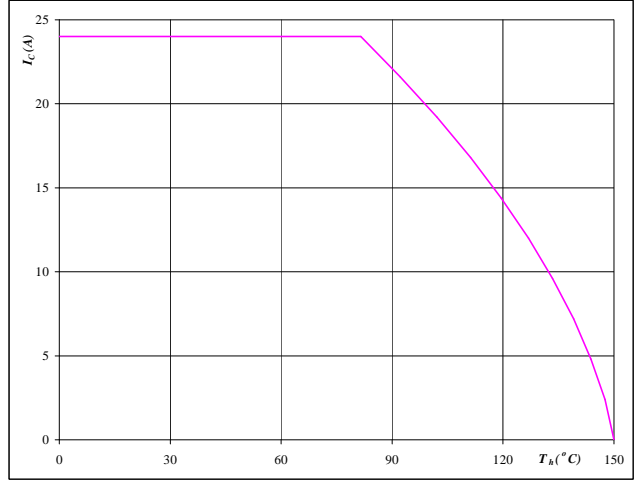

At
 $T_j = 150$ °C
 $V_{GE} = 15$ V

Figure 23 D1,D2,D3,D4,D5,D6 FWD

Power dissipation as a function of heatsink temperature

$P_{tot} = f(T_h)$

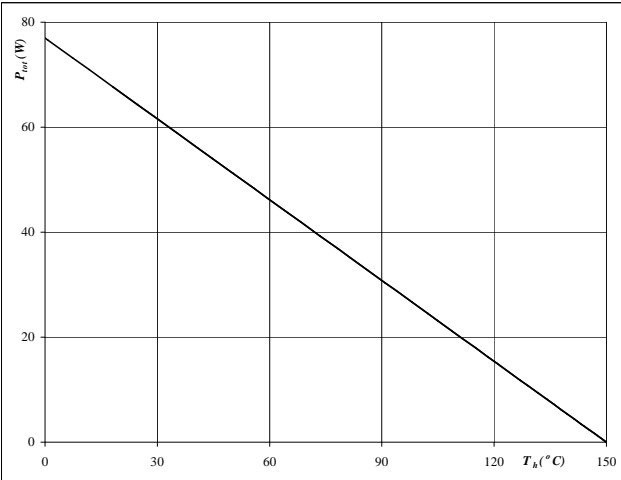

At
 $T_j = 150$ °C

Figure 24 D1,D2,D3,D4,D5,D6 FWD

Forward current as a function of heatsink temperature

$I_F = f(T_h)$

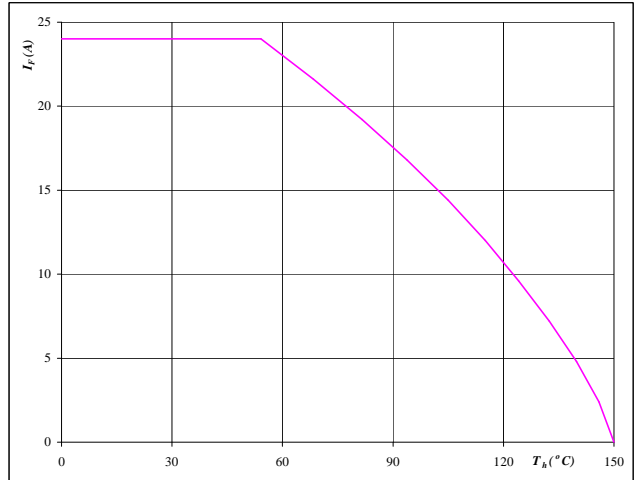

At
 $T_j = 150$ °C

T1,T2,T3,T4,T5,T6 / D1,D2,D3,D4,D5,D6

Figure 25 T1,T2,T3,T4,T5,T6 IGBT

Safe operating area as a function of collector-emitter voltage
 $I_C = f(V_{CE})$

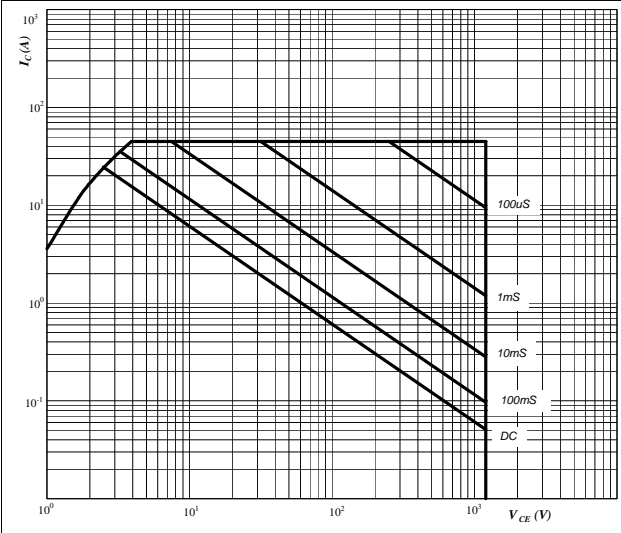

At
 D = single pulse
 $T_h = 80 \text{ } ^\circ\text{C}$
 $V_{GE} = \pm 15 \text{ V}$
 $T_j = T_{jmax} \text{ } ^\circ\text{C}$

Figure 26 T1,T2,T3,T4,T5,T6 IGBT

Gate voltage vs Gate charge
 $V_{GE} = f(Q_{GE})$

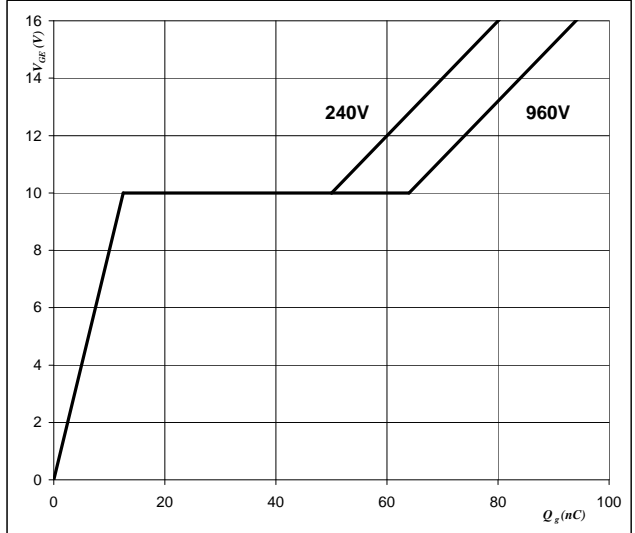

At
 $I_C = 15 \text{ A}$

Thermistor

Figure 1 Thermistor

Typical PTC characteristic as a function of temperature
 $R_T = f(T)$

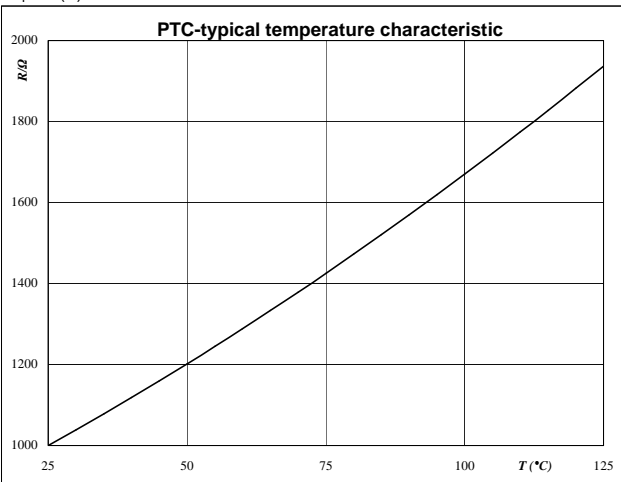

Switching Definitions Output Inverter

General conditions	
T_j	= 150 °C
R_{gon}	= 32 Ω
R_{goff}	= 32 Ω

Figure 1 Output inverter IGBT

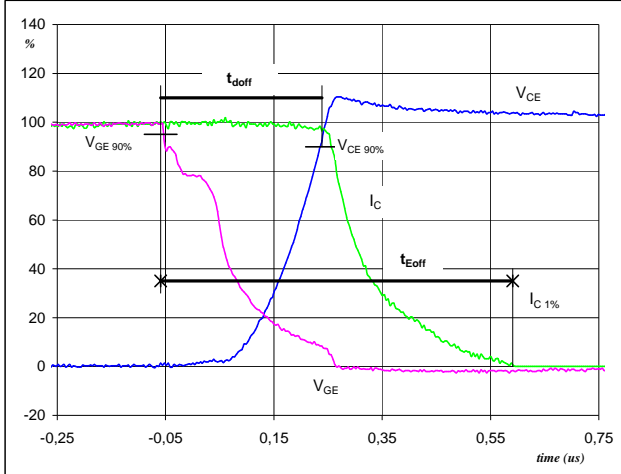
Turn-off Switching Waveforms & definition of t_{doff} , t_{Eoff}
(t_{Eoff} = integrating time for E_{off})

$V_{GE}(0\%) =$	-15	V
$V_{GE}(100\%) =$	15	V
$V_C(100\%) =$	600	V
$I_C(100\%) =$	15	A
$t_{doff} =$	0,29	μs
$t_{Eoff} =$	0,65	μs

Figure 2 Output inverter IGBT

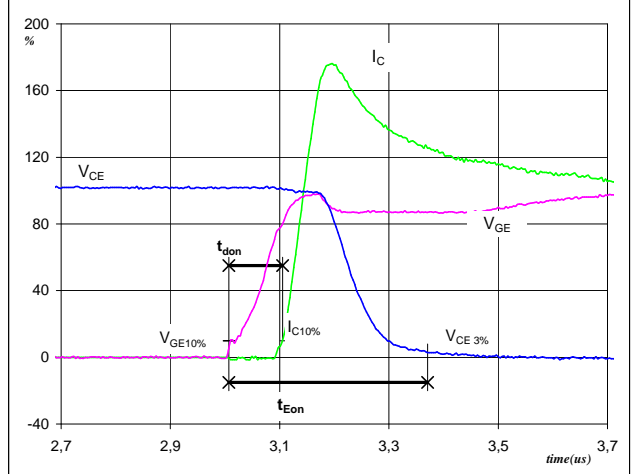
Turn-on Switching Waveforms & definition of t_{don} , t_{Eon}
(t_{Eon} = integrating time for E_{on})

$V_{GE}(0\%) =$	-15	V
$V_{GE}(100\%) =$	15	V
$V_C(100\%) =$	600	V
$I_C(100\%) =$	15	A
$t_{don} =$	0,10	μs
$t_{Eon} =$	0,36	μs

Figure 3 Output inverter IGBT

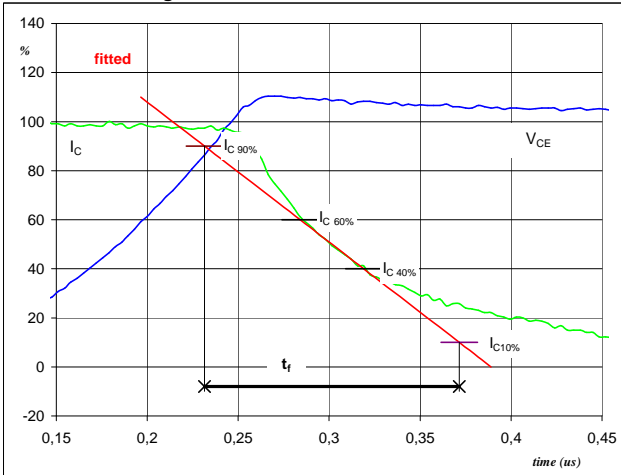
Turn-off Switching Waveforms & definition of t_f

$V_C(100\%) =$	600	V
$I_C(100\%) =$	15	A
$t_f =$	0,13	μs

Figure 4 Output inverter IGBT

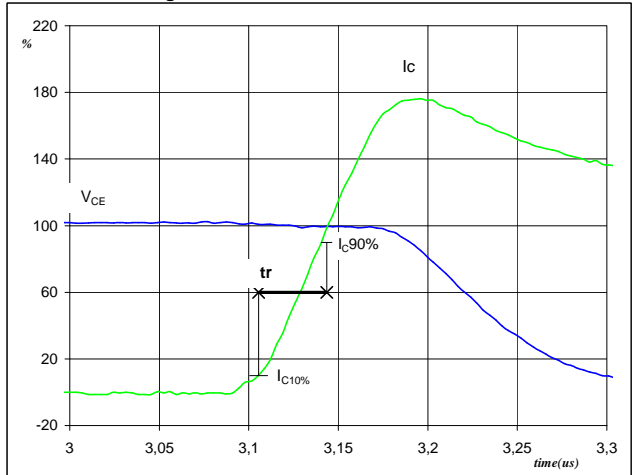
Turn-on Switching Waveforms & definition of t_r

$V_C(100\%) =$	600	V
$I_C(100\%) =$	15	A
$t_r =$	0,04	μs

Switching Definitions Output Inverter

Figure 5 Output inverter IGBT

Turn-off Switching Waveforms & definition of t_{Eoff}

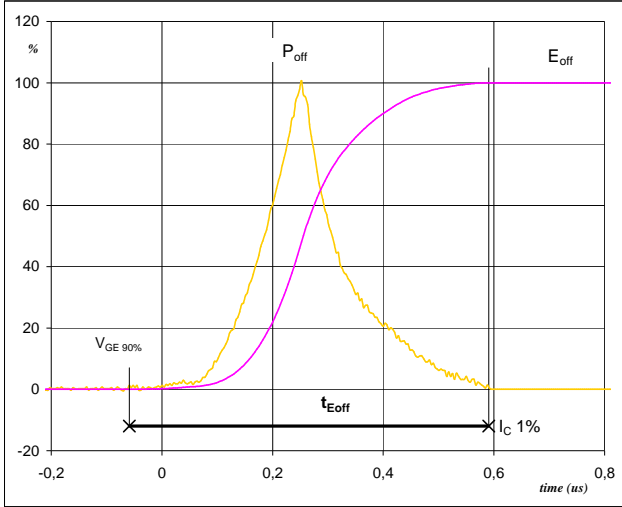

$P_{off}(100\%) =$	9,01	kW
$E_{off}(100\%) =$	1,48	mJ
$t_{Eoff} =$	0,65	μ s

Figure 6 Output inverter IGBT

Turn-on Switching Waveforms & definition of t_{Eon}

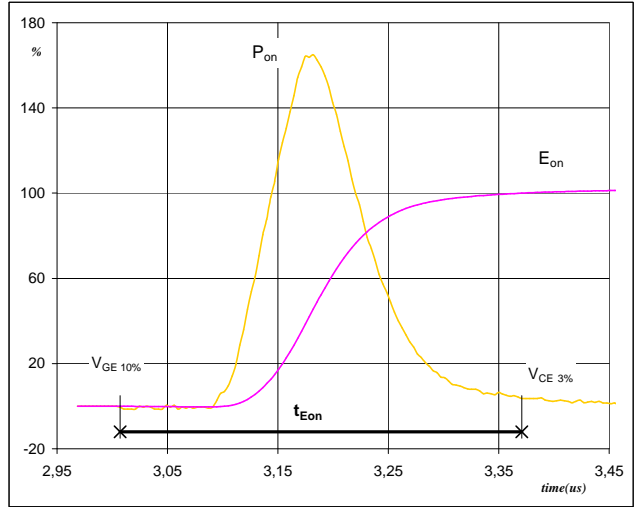

$P_{on}(100\%) =$	9,01	kW
$E_{on}(100\%) =$	1,52	mJ
$t_{Eon} =$	0,36	μ s

Figure 7 Output inverter FWD

Turn-off Switching Waveforms & definition of t_{tr}

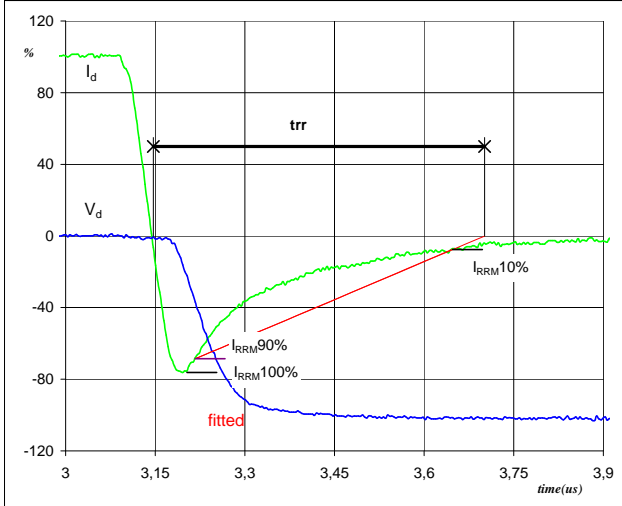

$V_d(100\%) =$	600	V
$I_d(100\%) =$	15	A
$I_{RRM}(100\%) =$	-11	A
$t_{tr} =$	0,54	μ s

Switching Definitions Output Inverter

Figure 8 Output inverter FWD

Turn-on Switching Waveforms & definition of t_{Qrr}
 (t_{Qrr} = integrating time for Q_{rr})

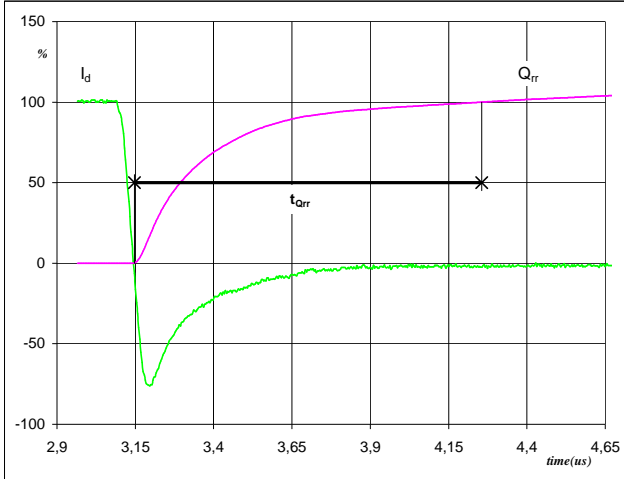

I_d (100%) =	15	A
Q_{rr} (100%) =	2,38	μC
t_{Qrr} =	1,11	μs

Figure 9 Output inverter FWD

Turn-on Switching Waveforms & definition of t_{Erec}
 (t_{Erec} = integrating time for E_{rec})

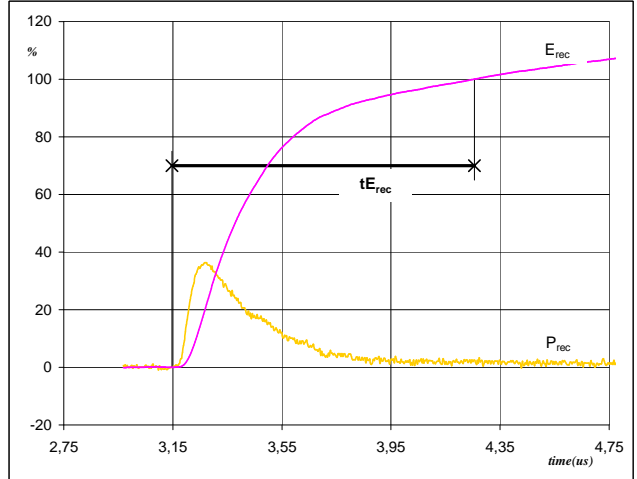

P_{rec} (100%) =	9,01	kW
E_{rec} (100%) =	0,98	mJ
t_{Erec} =	1,11	μs

Ordering Code and Marking - Outline - Pinout

Ordering Code & Marking

Version	Ordering Code	in DataMatrix as	in packaging barcode as
with std lid (black V23990-K12-T-PM)	V23990-K219-F-/0A/-PM	K219F	K219F-/0A/
with std lid (black V23990-K12-T-PM) and P12	V23990-K219-F-/1A/-PM	K219F	K219F-/1A/
with thin lid (white V23990-K13-T-PM)	V23990-K219-F-/0B/-PM	K219F	K219F-/0B/
with thin lid (white V23990-K13-T-PM) and P12	V23990-K219-F-/1B/-PM	K219F	K219F-/1B/

Outline

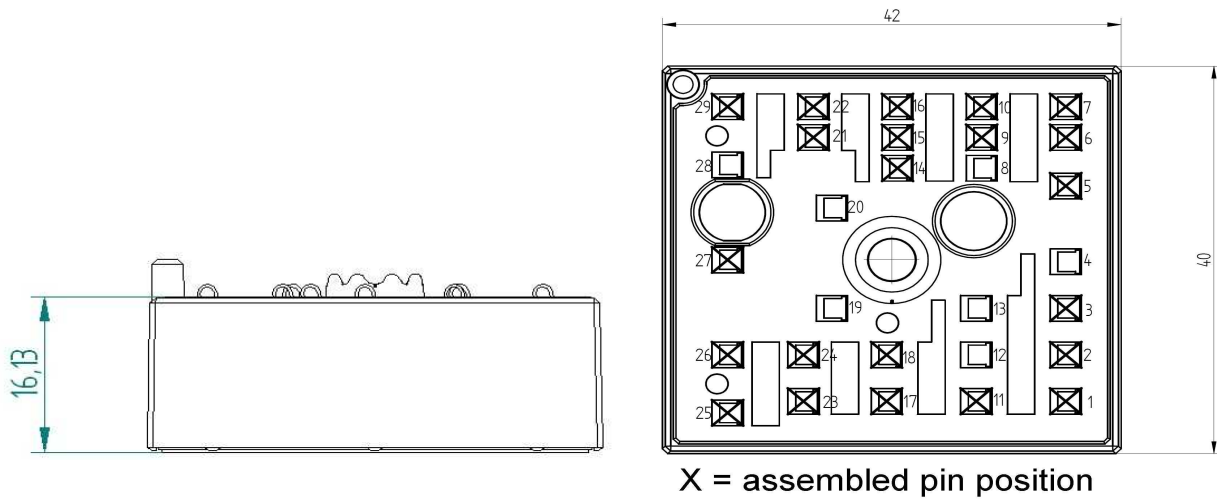

Pinout

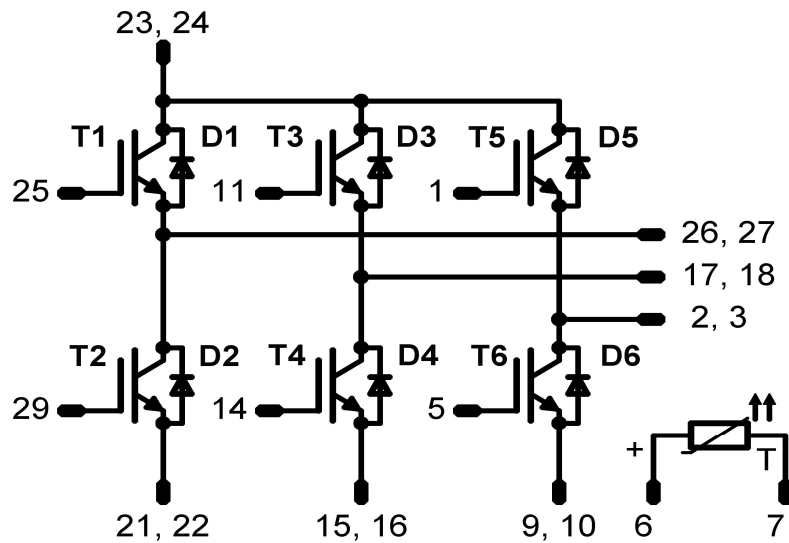

DISCLAIMER

The information given in this datasheet describes the type of component and does not represent assured characteristics. For tested values please contact Vincotech. Vincotech reserves the right to make changes without further notice to any products herein to improve reliability, function or design. Vincotech does not assume any liability arising out of the application or use of any product or circuit described herein; neither does it convey any license under its patent rights, nor the rights of others.

LIFE SUPPORT POLICY

Vincotech products are not authorised for use as critical components in life support devices or systems without the express written approval of Vincotech.

As used herein:

1. Life support devices or systems are devices or systems which, (a) are intended for surgical implant into the body, or (b) support or sustain life, or (c) whose failure to perform when properly used in accordance with instructions for use provided in labelling can be reasonably expected to result in significant injury to the user.
2. A critical component is any component of a life support device or system whose failure to perform can be reasonably expected to cause the failure of the life support device or system, or to affect its safety or effectiveness.