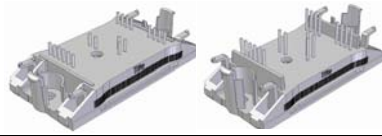
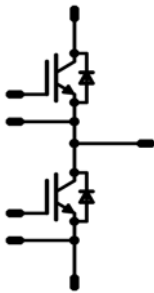

<i>flow</i> PHASE 0	1200 V/100 A
<div style="border: 1px solid black; padding: 5px; margin-bottom: 5px;"> <p style="text-align: center; background-color: #000080; color: white; margin: 0;"><b>Features</b></p> <ul style="list-style-type: none"> <li>Trench Fieldstop IGBT<sup>4</sup> technology</li> <li>2-clip housing in 12mm and 17mm height</li> <li>Compact and low inductance design</li> <li>AlN substrate for improved performance</li> </ul> </div> <div style="border: 1px solid black; padding: 5px; margin-bottom: 5px;"> <p style="text-align: center; background-color: #000080; color: white; margin: 0;"><b>Target Applications</b></p> <ul style="list-style-type: none"> <li>Motor Drive</li> <li>UPS</li> </ul> </div> <div style="border: 1px solid black; padding: 5px;"> <p style="text-align: center; background-color: #000080; color: white; margin: 0;"><b>Types</b></p> <ul style="list-style-type: none"> <li>FZ122PA100SC01</li> <li>F0122PA100SC01</li> </ul> </div>	<div style="border: 1px solid black; padding: 5px; margin-bottom: 5px;"> <p style="text-align: center; background-color: #000080; color: white; margin: 0;"><i>flow</i> 0 housing</p>  </div> <div style="border: 1px solid black; padding: 5px;"> <p style="text-align: center; background-color: #000080; color: white; margin: 0;"><b>Schematic</b></p>  </div>

### Maximum Ratings

$T_j=25^{\circ}\text{C}$ , unless otherwise specified

Parameter	Symbol	Condition	Value	Unit
<b>Inverter Transistor</b>				
Collector-emitter break down voltage	$V_{CE}$		1200	V
DC collector current	$I_C$	$T_j=T_{jmax}$ $T_h=80^{\circ}\text{C}$ $T_c=80^{\circ}\text{C}$	111 142	A
Repetitive peak collector current	$I_{Cpulse}$	$t_p$ limited by $T_{jmax}$	300	A
Power dissipation per IGBT	$P_{tot}$	$T_j=T_{jmax}$ $T_h=80^{\circ}\text{C}$ $T_c=80^{\circ}\text{C}$	297 450	W
Gate-emitter peak voltage	$V_{GE}$		$\pm 20$	V
Short circuit ratings	$t_{SC}$ $V_{CC}$	$T_j \leq 150^{\circ}\text{C}$ $V_{GE} = 15\text{V}$	10 800	$\mu\text{s}$ V
Maximum Junction Temperature	$T_{jmax}$		175	$^{\circ}\text{C}$
<b>Inverter Diode</b>				
Peak Repetitive Reverse Voltage	$V_{RRM}$	$T_j=25^{\circ}\text{C}$	1200	V
DC forward current	$I_F$	$T_j=T_{jmax}$ $T_h=80^{\circ}\text{C}$ $T_c=80^{\circ}\text{C}$	103 130	A
Repetitive peak forward current	$I_{FRM}$	$t_p$ limited by $T_{jmax}$	200	A
Power dissipation per Diode	$P_{tot}$	$T_j=T_{jmax}$ $T_h=80^{\circ}\text{C}$ $T_c=80^{\circ}\text{C}$	187 284	W
Maximum Junction Temperature	$T_{jmax}$		175	$^{\circ}\text{C}$

### Maximum Ratings

 $T_j=25^{\circ}\text{C}$ , unless otherwise specified

Parameter	Symbol	Condition	Value	Unit
-----------	--------	-----------	-------	------

#### Thermal Properties

Storage temperature	$T_{\text{stg}}$		-40...+125	$^{\circ}\text{C}$
Operation temperature under switching condition	$T_{\text{op}}$		-40...+( $T_{\text{jmax}}$ - 25)	$^{\circ}\text{C}$

#### Insulation Properties

Insulation voltage	$V_{\text{is}}$	$t=2\text{s}$ DC voltage	4000	V
Creepage distance			min 12,7	mm
Clearance			min 12,7	mm

**Characteristic Values**

Parameter	Symbol	Conditions					Value			Unit
		$V_{GE}[V]$ or $V_{GS}[V]$	$V_r[V]$ or $V_{CE}[V]$ or $V_{DS}[V]$	$I_c[A]$ or $I_F[A]$ or $I_b[A]$	$T_j$	Min	Typ	Max		
<b>Inverter Transistor</b>										
Gate emitter threshold voltage	$V_{GE(th)}$	$V_{CE}=V_{GE}$			0,0036	$T_j=25^\circ C$ $T_j=150^\circ C$	5	5,8	6,5	V
Collector-emitter saturation voltage	$V_{CE(sat)}$		15		100	$T_j=25^\circ C$ $T_j=150^\circ C$	1,5	1,95 2,39	2,3	V
Collector-emitter cut-off current incl. Diode	$I_{CES}$		0	1200		$T_j=25^\circ C$ $T_j=150^\circ C$			0,035	mA
Gate-emitter leakage current	$I_{GES}$		20	0		$T_j=25^\circ C$ $T_j=150^\circ C$			700	nA
Integrated Gate resistor	$R_{gint}$							7,5		$\Omega$
Turn-on delay time	$t_{d(on)}$	Rgoff=4 $\Omega$ Rgon=4 $\Omega$	$\pm 15$	600	100	$T_j=25^\circ C$		193		ns
Rise time	$t_r$					$T_j=150^\circ C$		210		
Turn-off delay time	$t_{d(off)}$					$T_j=25^\circ C$		32		
Fall time	$t_f$					$T_j=150^\circ C$		42		
Turn-on energy loss per pulse	$E_{on}$					$T_j=25^\circ C$		299		
Turn-off energy loss per pulse	$E_{off}$					$T_j=150^\circ C$		383		
Input capacitance	$C_{ies}$									
Output capacitance	$C_{oss}$	f=1MHz	0	25		$T_j=25^\circ C$		405		
Reverse transfer capacitance	$C_{rss}$							345		
Gate charge	$Q_{Gate}$		$\pm 15$			$T_j=25^\circ C$		386		nC
Thermal resistance chip to heatsink per chip	$R_{thJH}$	Thermal foil thickness=76um						0,32		K/W
Thermal resistance chip to case per chip	$R_{thJC}$	Kunze foil KU-ALF5								
<b>Inverter Diode</b>										
Diode forward voltage	$V_F$				50	$T_j=25^\circ C$ $T_j=150^\circ C$	1	1,81 1,77	2,3	V
Peak reverse recovery current	$I_{RRM}$	Rgon=4 $\Omega$	$\pm 15$	600	100	$T_j=25^\circ C$		98,18		A
Reverse recovery time	$t_{rr}$					$T_j=150^\circ C$		113,5		
Reverse recovered charge	$Q_{rr}$					$T_j=25^\circ C$		283,4		
Peak rate of fall of recovery current	$di(rec)max/dt$					$T_j=150^\circ C$		454,7		
Reverse recovered energy	Erec					$T_j=25^\circ C$		8,93		
						$T_j=150^\circ C$		18,06		
Thermal resistance chip to heatsink per chip	$R_{thJH}$	Thermal foil thickness=76um						0,51		K/W
Thermal resistance chip to case per chip	$R_{thJC}$	Kunze foil KU-ALF5								

### Output Inverter

**Figure 1** Output inverter IGBT

**Typical output characteristics**

$$I_C = f(V_{CE})$$

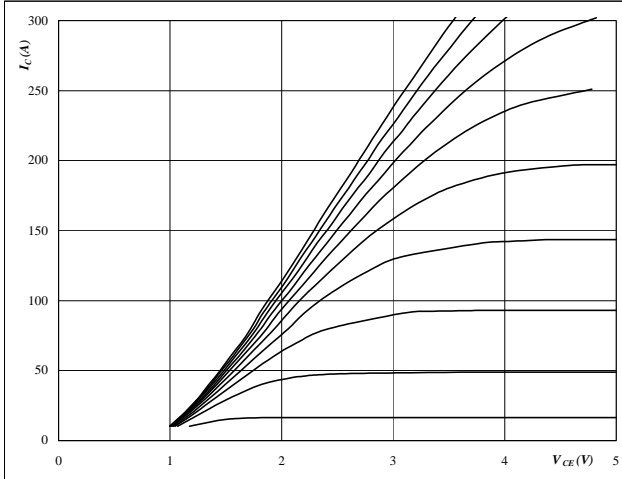

**At**  
 $t_p = 350 \mu s$   
 $T_J = 25 \text{ } ^\circ C$   
 $V_{GE}$  from 7 V to 17 V in steps of 1 V

**Figure 2** Output inverter IGBT

**Typical output characteristics**

$$I_C = f(V_{CE})$$

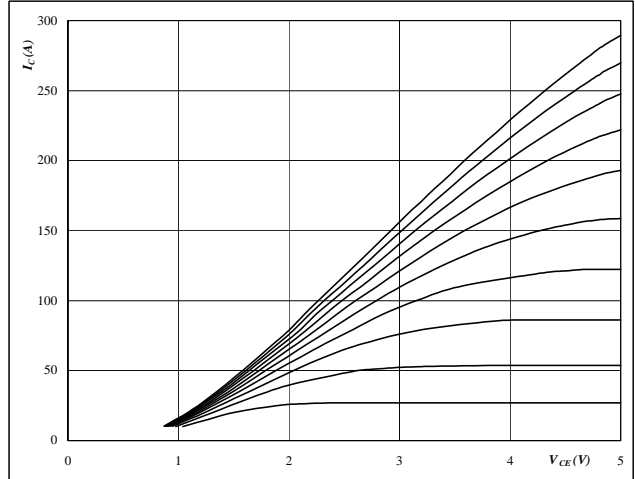

**At**  
 $t_p = 350 \mu s$   
 $T_J = 150 \text{ } ^\circ C$   
 $V_{GE}$  from 7 V to 17 V in steps of 1 V

**Figure 3** Output inverter IGBT

**Typical transfer characteristics**

$$I_C = f(V_{GE})$$

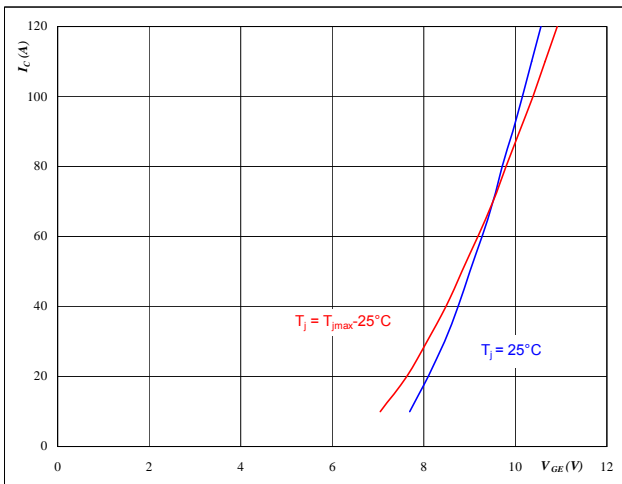

**At**  
 $t_p = 350 \mu s$   
 $V_{CE} = 10 V$

**Figure 4** Output inverter FRED

**Typical diode forward current as a function of forward voltage**

$$I_F = f(V_F)$$

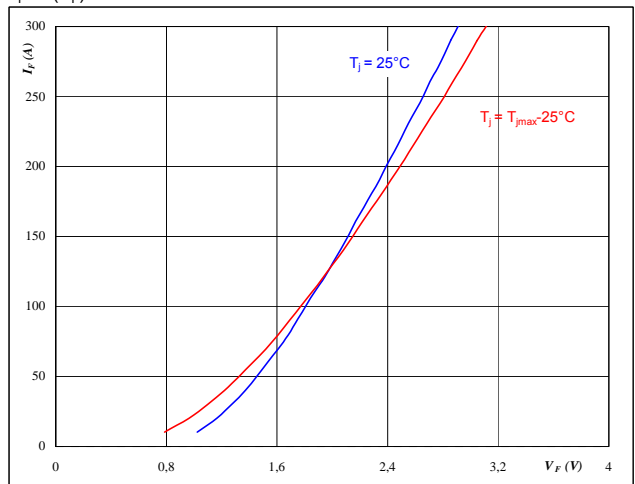

**At**  
 $t_p = 350 \mu s$

### Output Inverter

**Figure 5** Output inverter IGBT

**Typical switching energy losses as a function of collector current**  
 $E = f(I_C)$

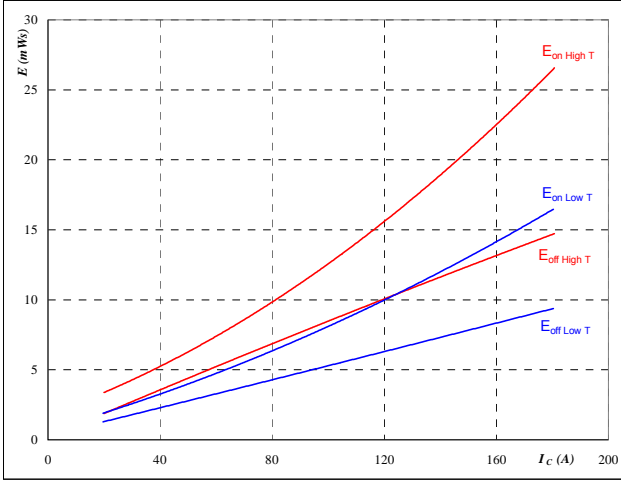

With an inductive load at  
 $T_J = 25/150 \text{ } ^\circ\text{C}$   
 $V_{CE} = 600 \text{ V}$   
 $V_{GE} = \pm 15 \text{ V}$   
 $R_{gon} = 4 \text{ } \Omega$   
 $R_{goff} = 4 \text{ } \Omega$

**Figure 6** Output inverter IGBT

**Typical switching energy losses as a function of gate resistor**  
 $E = f(R_G)$

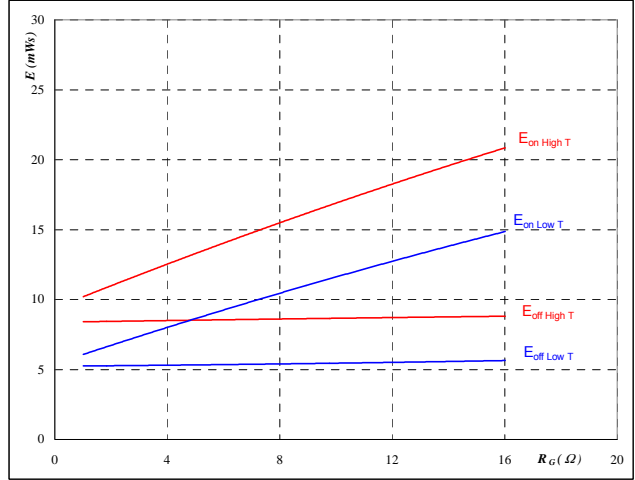

With an inductive load at  
 $T_J = 25/150 \text{ } ^\circ\text{C}$   
 $V_{CE} = 600 \text{ V}$   
 $V_{GE} = \pm 15 \text{ V}$   
 $I_C = 100 \text{ A}$

**Figure 7** Output inverter IGBT

**Typical reverse recovery energy loss as a function of collector current**  
 $E_{rec} = f(I_C)$

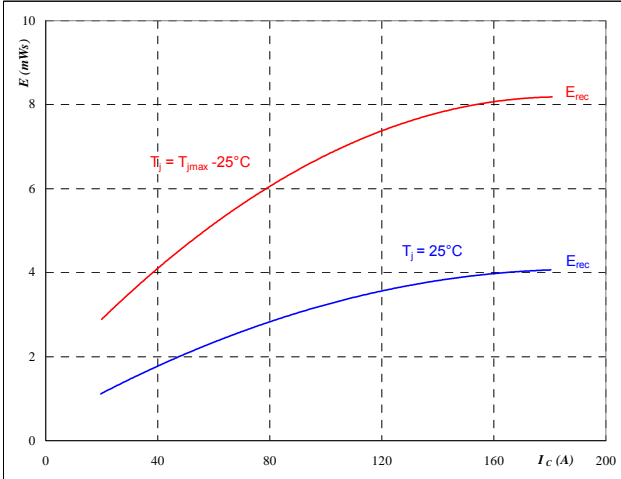

With an inductive load at  
 $T_J = 25/150 \text{ } ^\circ\text{C}$   
 $V_{CE} = 600 \text{ V}$   
 $V_{GE} = \pm 15 \text{ V}$   
 $R_{gon} = 4 \text{ } \Omega$

**Figure 8** Output inverter IGBT

**Typical reverse recovery energy loss as a function of gate resistor**  
 $E_{rec} = f(R_G)$

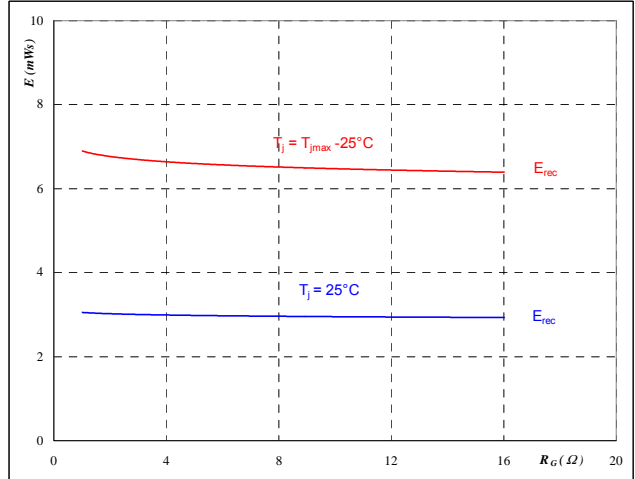

With an inductive load at  
 $T_J = 25/150 \text{ } ^\circ\text{C}$   
 $V_{CE} = 600 \text{ V}$   
 $V_{GE} = \pm 15 \text{ V}$   
 $I_C = 100 \text{ A}$

### Output Inverter

**Figure 9** Output inverter IGBT

Typical switching times as a function of collector current  
 $t = f(I_C)$

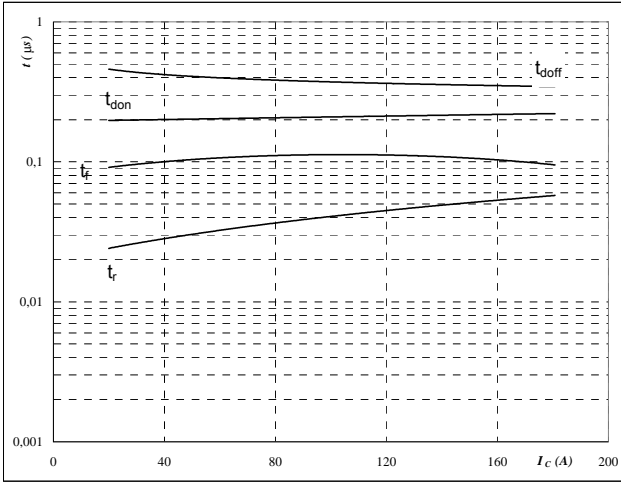

With an inductive load at

$T_J =$	150	°C
$V_{CE} =$	600	V
$V_{GE} =$	±15	V
$R_{gon} =$	4	Ω
$R_{goff} =$	4	Ω

**Figure 10** Output inverter IGBT

Typical switching times as a function of gate resistor  
 $t = f(R_G)$

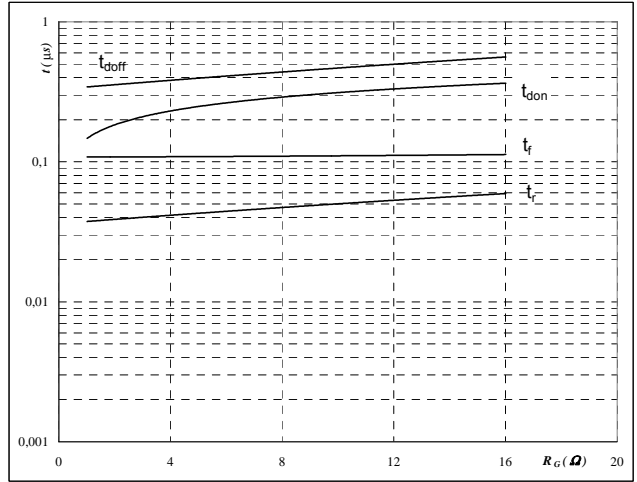

With an inductive load at

$T_J =$	150	°C
$V_{CE} =$	600	V
$V_{GE} =$	±15	V
$I_C =$	100	A

**Figure 11** Output inverter FRED

Typical reverse recovery time as a function of collector current  
 $t_{rr} = f(I_C)$

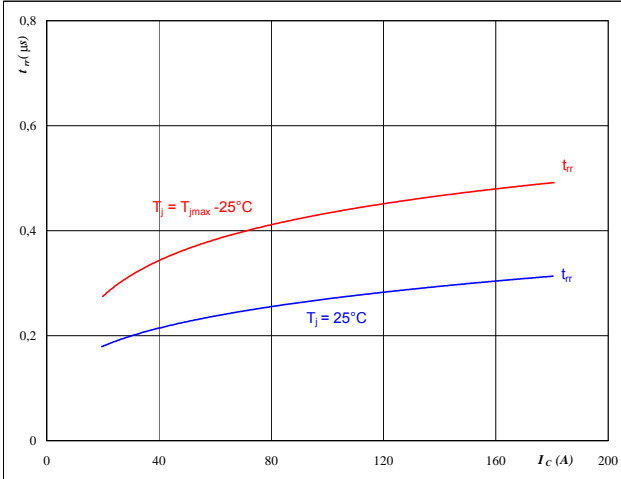

At

$T_J =$	25/150	°C
$V_{CE} =$	600	V
$V_{GE} =$	±15	V
$R_{gon} =$	4	Ω

**Figure 12** Output inverter FRED

Typical reverse recovery time as a function of IGBT turn on gate resistor  
 $t_{rr} = f(R_{gon})$

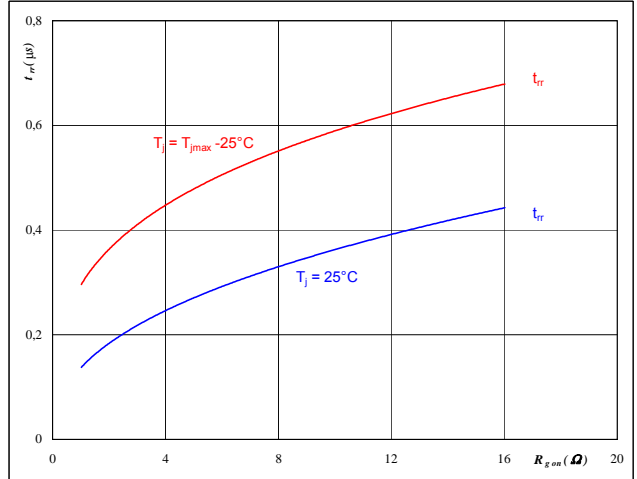

At

$T_J =$	25/150	°C
$V_R =$	600	V
$I_F =$	100	A
$V_{GE} =$	±15	V

### Output Inverter

**Figure 13** Output inverter FRED

Typical reverse recovery charge as a function of collector current

$$Q_{rr} = f(I_C)$$

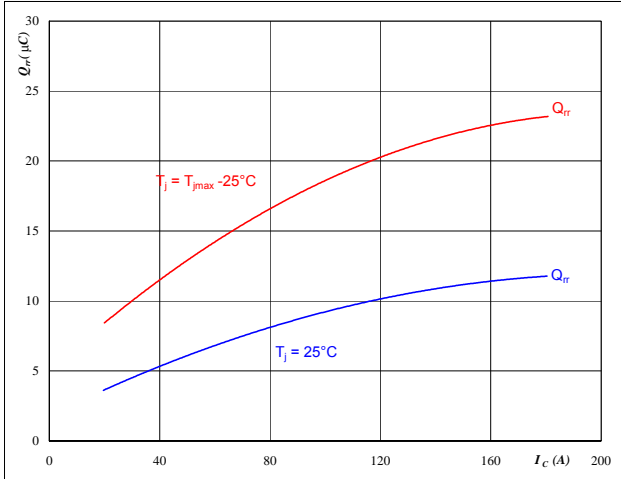

**At**  
 $T_j = 25/150$  °C  
 $V_{CE} = 600$  V  
 $V_{GE} = \pm 15$  V  
 $R_{gon} = 4$  Ω

**Figure 14** Output inverter FRED

Typical reverse recovery charge as a function of IGBT turn on gate resistor

$$Q_{rr} = f(R_{gon})$$

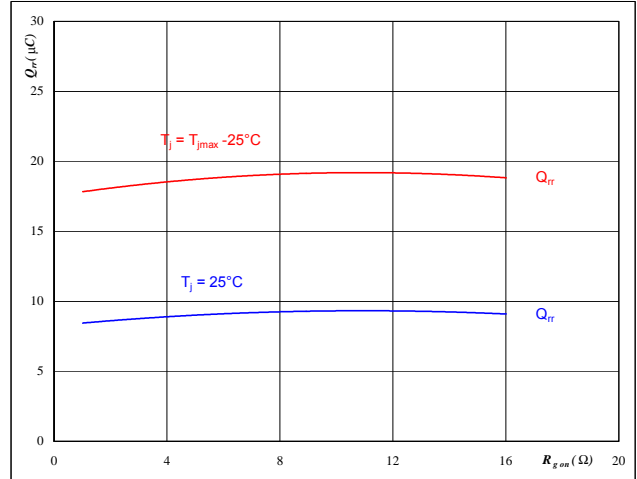

**At**  
 $T_j = 25/150$  °C  
 $V_R = 600$  V  
 $I_F = 100$  A  
 $V_{GE} = \pm 15$  V

**Figure 15** Output inverter FRED

Typical reverse recovery current as a function of collector current

$$I_{RRM} = f(I_C)$$

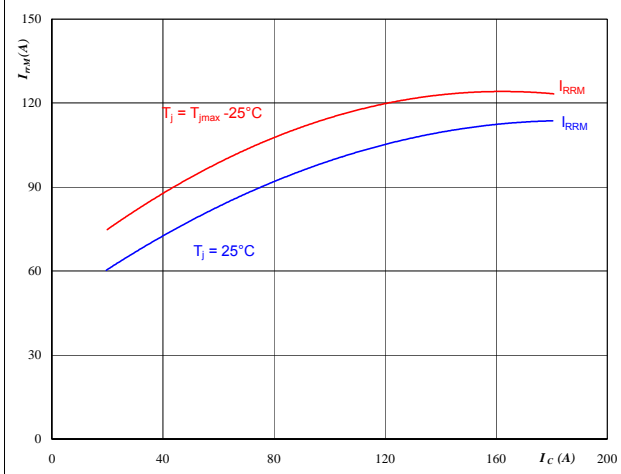

**At**  
 $T_j = 25/150$  °C  
 $V_{CE} = 600$  V  
 $V_{GE} = \pm 15$  V  
 $R_{gon} = 4$  Ω

**Figure 16** Output inverter FRED

Typical reverse recovery current as a function of IGBT turn on gate resistor

$$I_{RRM} = f(R_{gon})$$

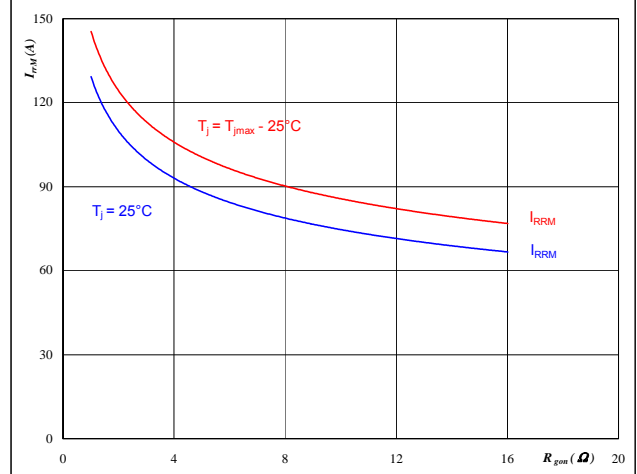

**At**  
 $T_j = 25/150$  °C  
 $V_R = 600$  V  
 $I_F = 100$  A  
 $V_{GE} = \pm 15$  V

## Output Inverter

Figure 17 Output inverter FRED

Typical rate of fall of forward and reverse recovery current as a function of collector current

$$dI_f/dt, dI_{rec}/dt = f(I_c)$$

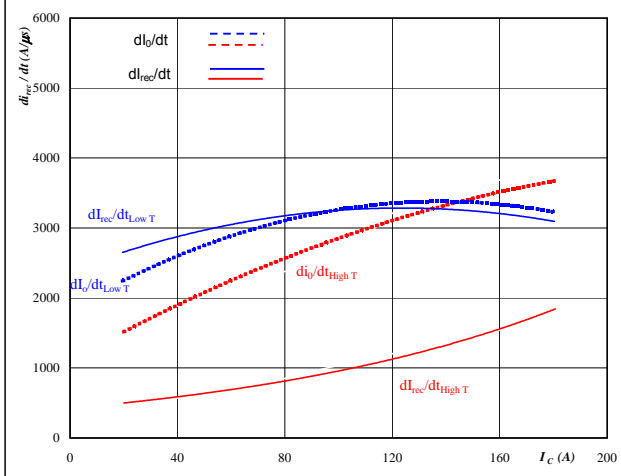

At  
 $T_j = 25/150$  °C  
 $V_{CE} = 600$  V  
 $V_{GE} = \pm 15$  V  
 $R_{gon} = 4$  Ω

Figure 18 Output inverter FRED

Typical rate of fall of forward and reverse recovery current as a function of IGBT turn on gate resistor

$$dI_f/dt, dI_{rec}/dt = f(R_{gon})$$

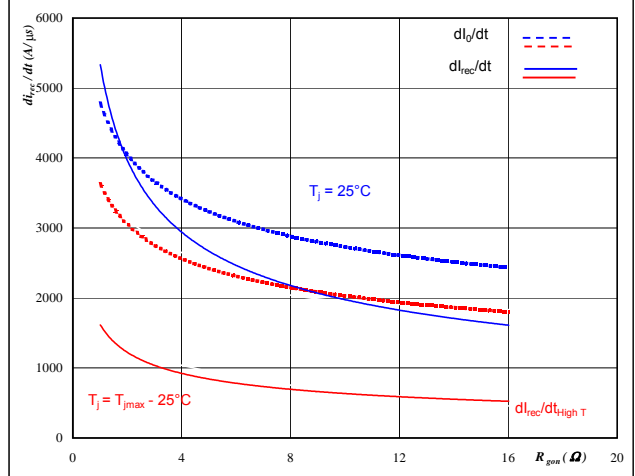

At  
 $T_j = 25/150$  °C  
 $V_R = 600$  V  
 $I_F = 100$  A  
 $V_{GE} = \pm 15$  V

Figure 19 Output inverter IGBT

IGBT transient thermal impedance as a function of pulse width

$$Z_{thJH} = f(t_p)$$

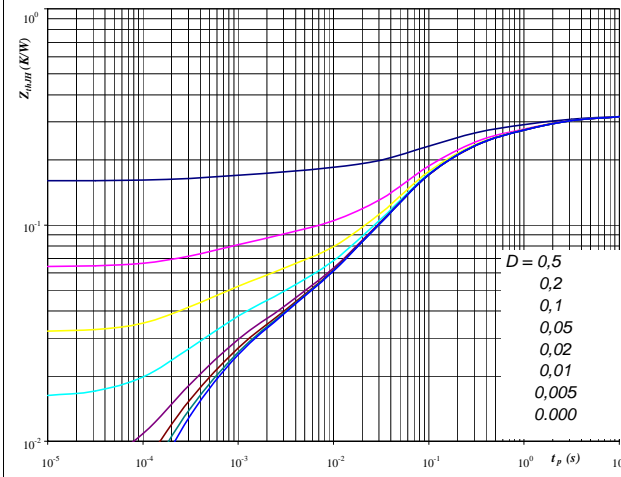

At  
 $D = t_p / T$   
 $R_{thJH} = 0,32$  K/W

IGBT thermal model values

R (C/W)	Tau (s)
0,03	4,4E+00
0,06	9,7E-01
0,11	1,5E-01
0,08	4,2E-02
0,02	2,5E-03
0,02	3,5E-04

Figure 20 Output inverter FRED

FRED transient thermal impedance as a function of pulse width

$$Z_{thJH} = f(t_p)$$

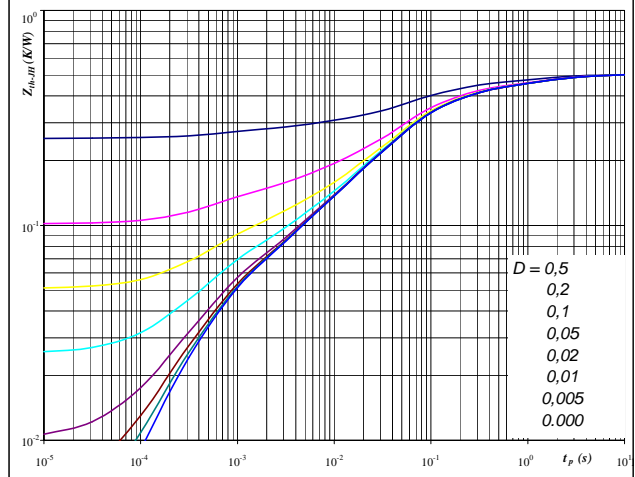

At  
 $D = t_p / T$   
 $R_{thJH} = 0,51$  K/W

FRED thermal model values

R (C/W)	Tau (s)
0,02	9,2E+00
0,08	1,2E+00
0,14	1,5E-01
0,18	3,9E-02
0,05	4,2E-03
0,04	5,1E-04



## Output Inverter

**Figure 21** Output inverter IGBT

**Power dissipation as a function of heatsink temperature**

$$P_{tot} = f(T_h)$$

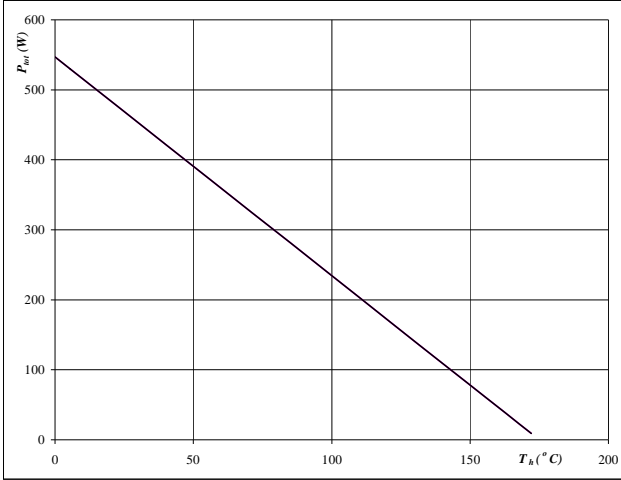

At  $T_j = 175$  °C

— single heating  
— overall heating

**Figure 22** Output inverter IGBT

**Collector current as a function of heatsink temperature**

$$I_C = f(T_h)$$

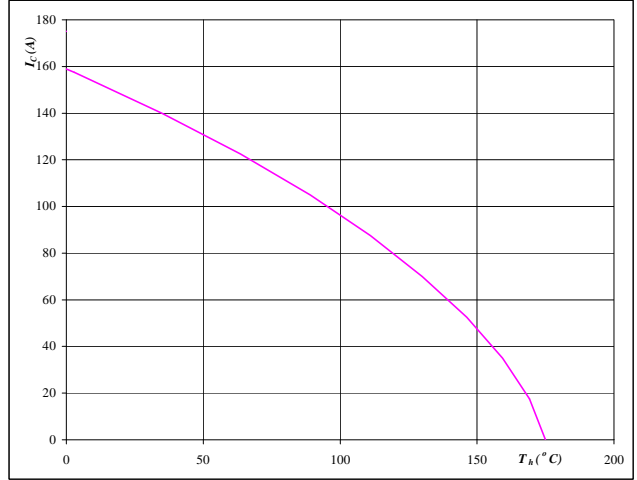

At  $T_j = 175$  °C  
 $V_{GE} = 15$  V

**Figure 23** Output inverter FRED

**Power dissipation as a function of heatsink temperature**

$$P_{tot} = f(T_h)$$

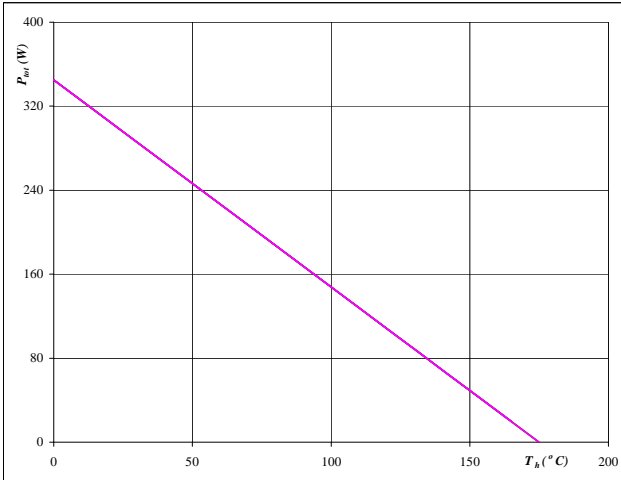

At  $T_j = 175$  °C

— single heating  
— overall heating

**Figure 24** Output inverter FRED

**Forward current as a function of heatsink temperature**

$$I_F = f(T_h)$$

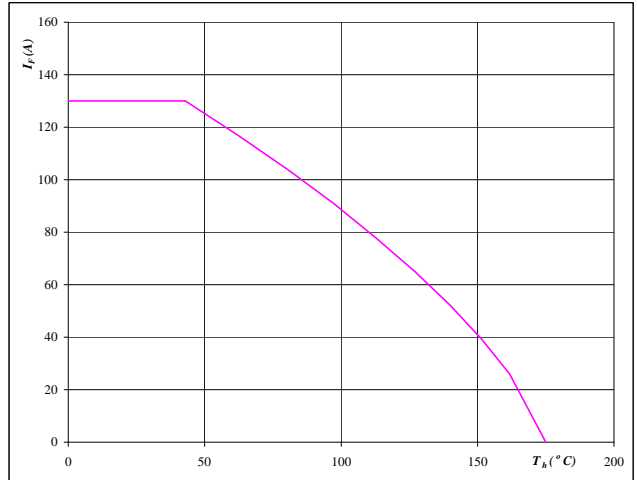

At  $T_j = 175$  °C

## Output Inverter

**Figure 25** Output inverter IGBT

**Safe operating area as a function of collector-emitter voltage**  
 $I_C = f(V_{CE})$

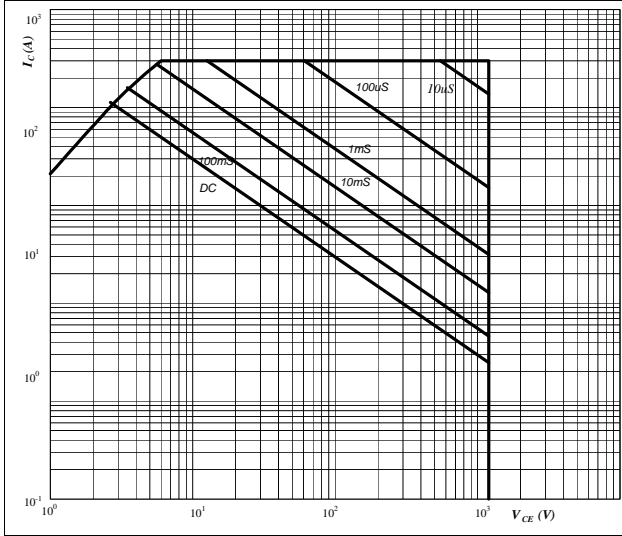

**At**  
D = single pulse  
 $T_n = 80$  °C  
 $V_{GE} = \pm 15$  V  
 $T_j = T_{jmax}$  °C

**Figure 26** Output inverter IGBT

**Gate voltage vs Gate charge**  
 $V_{GE} = f(Q_{GE})$

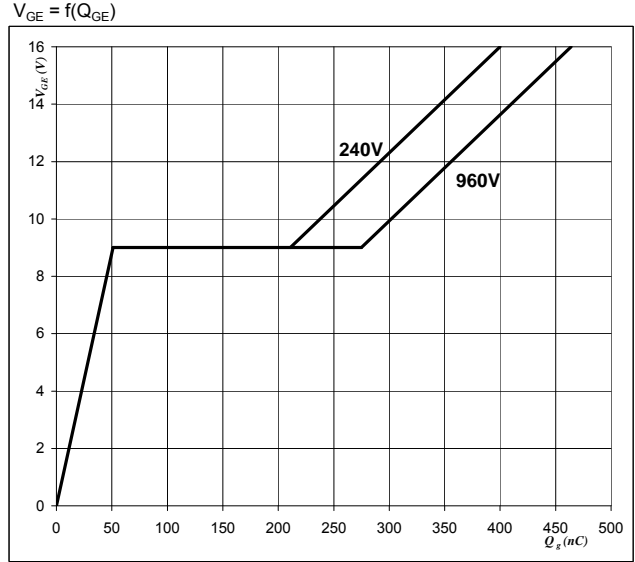

**At**  
 $I_C = 100$  A

### Switching Definitions Output Inverter

General conditions	
$T_j$	= 150 °C
$R_{gon}$	= 4 Ω
$R_{goff}$	= 4 Ω

**Figure 1** Output inverter IGBT

Turn-off Switching Waveforms & definition of  $t_{doff}$ ,  $t_{Eoff}$   
 ( $t_{Eoff}$  = integrating time for  $E_{off}$ )

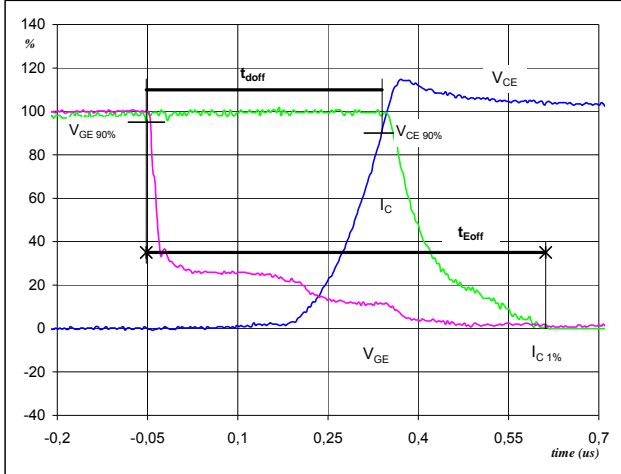

$V_{GE}(0\%) =$	-15	V
$V_{GE}(100\%) =$	15	V
$V_C(100\%) =$	600	V
$I_C(100\%) =$	99	A
$t_{doff} =$	0,38	μs
$t_{Eoff} =$	0,66	μs

**Figure 2** Output inverter IGBT

Turn-on Switching Waveforms & definition of  $t_{don}$ ,  $t_{Eon}$   
 ( $t_{Eon}$  = integrating time for  $E_{on}$ )

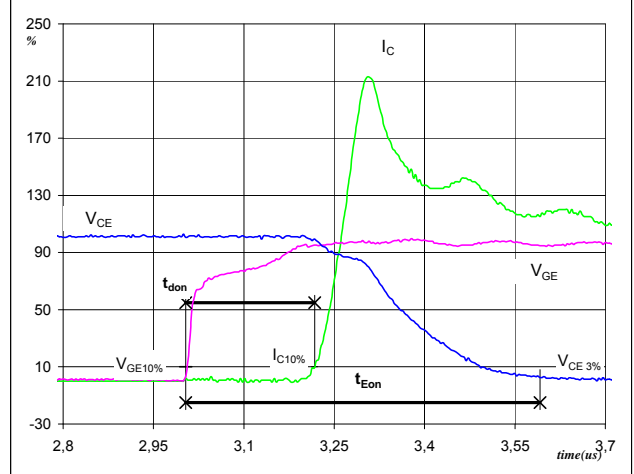

$V_{GE}(0\%) =$	-15	V
$V_{GE}(100\%) =$	15	V
$V_C(100\%) =$	600	V
$I_C(100\%) =$	99	A
$t_{don} =$	0,21	μs
$t_{Eon} =$	0,59	μs

**Figure 3** Output inverter IGBT

Turn-off Switching Waveforms & definition of  $t_f$

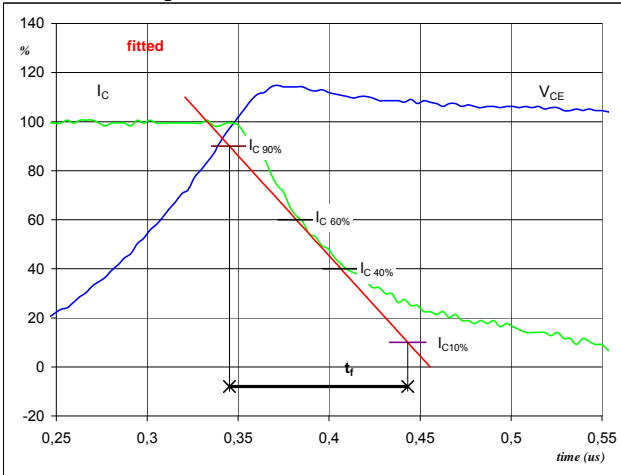

$V_C(100\%) =$	600	V
$I_C(100\%) =$	99	A
$t_f =$	0,11	μs

**Figure 4** Output inverter IGBT

Turn-on Switching Waveforms & definition of  $t_r$

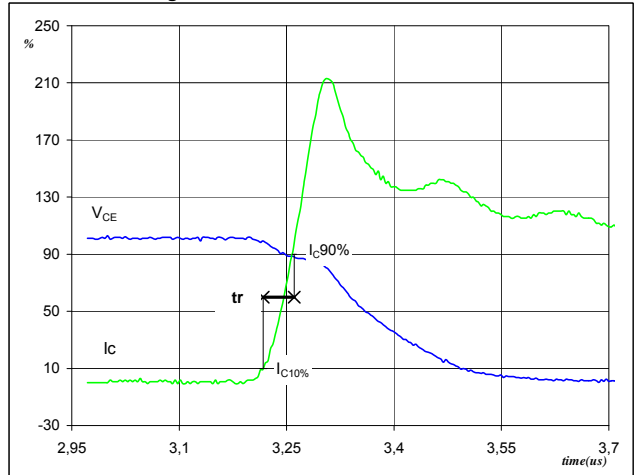

$V_C(100\%) =$	600	V
$I_C(100\%) =$	99	A
$t_r =$	0,04	μs

### Switching Definitions Output Inverter

**Figure 5** Output inverter IGBT

Turn-off Switching Waveforms & definition of  $t_{Eoff}$

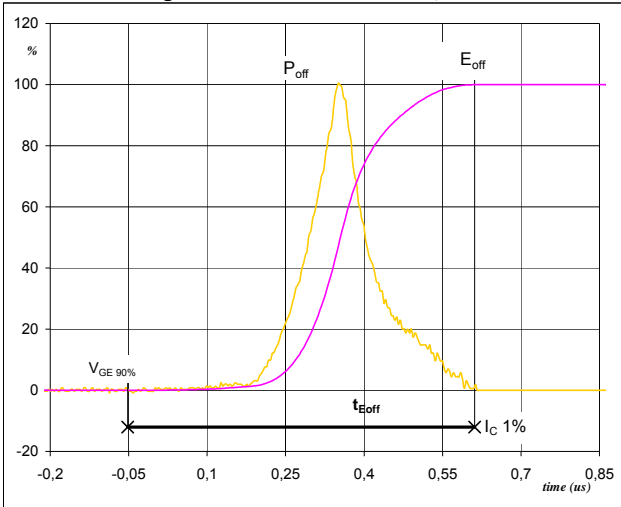

$P_{off} (100\%) = 59,42 \text{ kW}$   
 $E_{off} (100\%) = 8,45 \text{ mJ}$   
 $t_{Eoff} = 0,66 \text{ } \mu\text{s}$

**Figure 6** Output inverter IGBT

Turn-on Switching Waveforms & definition of  $t_{Eon}$

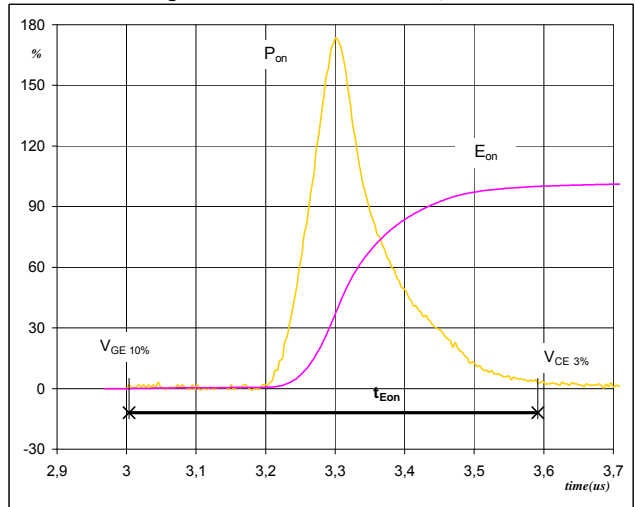

$P_{on} (100\%) = 59,42 \text{ kW}$   
 $E_{on} (100\%) = 12,38 \text{ mJ}$   
 $t_{Eon} = 0,59 \text{ } \mu\text{s}$

**Figure 7** Output inverter FRED

Gate voltage vs Gate charge (measured)

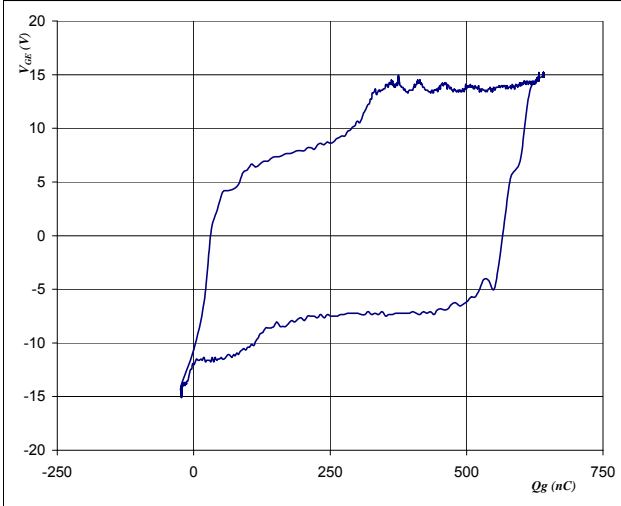

$V_{GEoff} = -15 \text{ V}$   
 $V_{GEon} = 15 \text{ V}$   
 $V_C (100\%) = 600 \text{ V}$   
 $I_C (100\%) = 99 \text{ A}$   
 $Q_g = 6433,37 \text{ nC}$

**Figure 8** Output inverter IGBT

Turn-off Switching Waveforms & definition of  $t_{rr}$

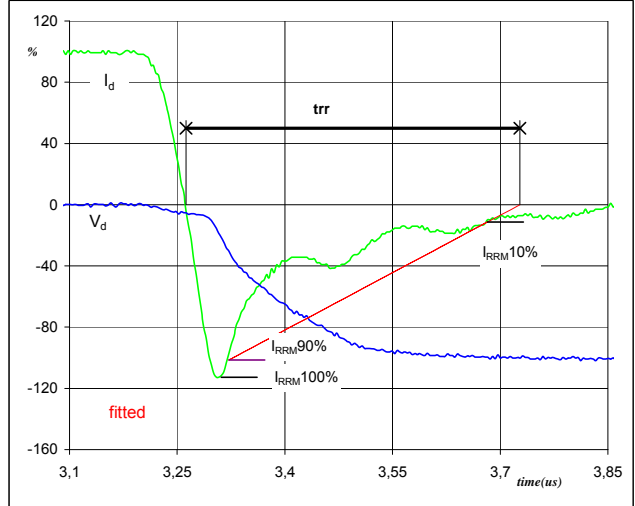

$V_d (100\%) = 600 \text{ V}$   
 $I_d (100\%) = 99 \text{ A}$   
 $I_{RRM} (100\%) = -113 \text{ A}$   
 $t_{rr} = 0,46 \text{ } \mu\text{s}$

## Switching Definitions Output Inverter

**Figure 9** Output inverter FRED

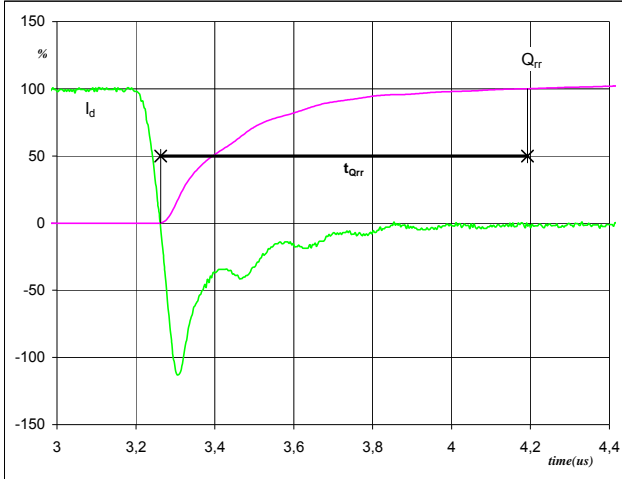
**Turn-on Switching Waveforms & definition of  $t_{Qrr}$**   
 ( $t_{Qrr}$  = integrating time for  $Q_{rr}$ )

$I_d$ (100%) =	99	A
$Q_{rr}$ (100%) =	18,12	$\mu\text{C}$
$t_{Qrr}$ =	0,93	$\mu\text{s}$

**Figure 10** Output inverter FRED

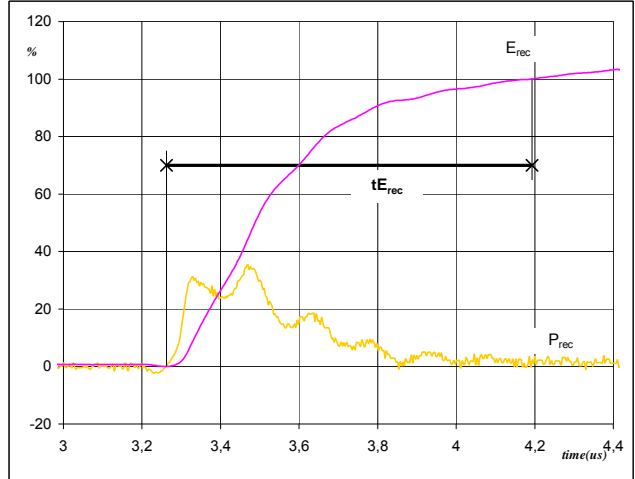
**Turn-on Switching Waveforms & definition of  $t_{Erec}$**   
 ( $t_{Erec}$  = integrating time for  $E_{rec}$ )

$P_{rec}$ (100%) =	59,42	kW
$E_{rec}$ (100%) =	6,60	mJ
$t_{Erec}$ =	0,93	$\mu\text{s}$

## Ordering Code and Marking - Outline - Pinout

### Ordering Code & Marking

Version	Ordering Code	in DataMatrix as	in packaging barcode as
without thermal paste 12mm housing	10-FZ122PA100SC01-P999F18	P999F18	P999F18
without thermal paste 17mm housing	10-F0122PA100SC01-P999F19	P999F19	P999F19

### Outline

Pin table		
Pin	X	Y
1	0	0
2	0	2,3
3	0	4,6
4	0	6,9
5	0	15,6
6	0	17,9
7	0	20,2
8	0	22,5
9	13,85	16,45
10	16,75	16,45
11	33,5	11,5
12	33,5	9,2
13	33,5	6,9
14	33,5	4,6
15	33,5	2,3
16	33,5	0
17	13,85	13,55
18	19,55	4,95
19	19,55	7,85

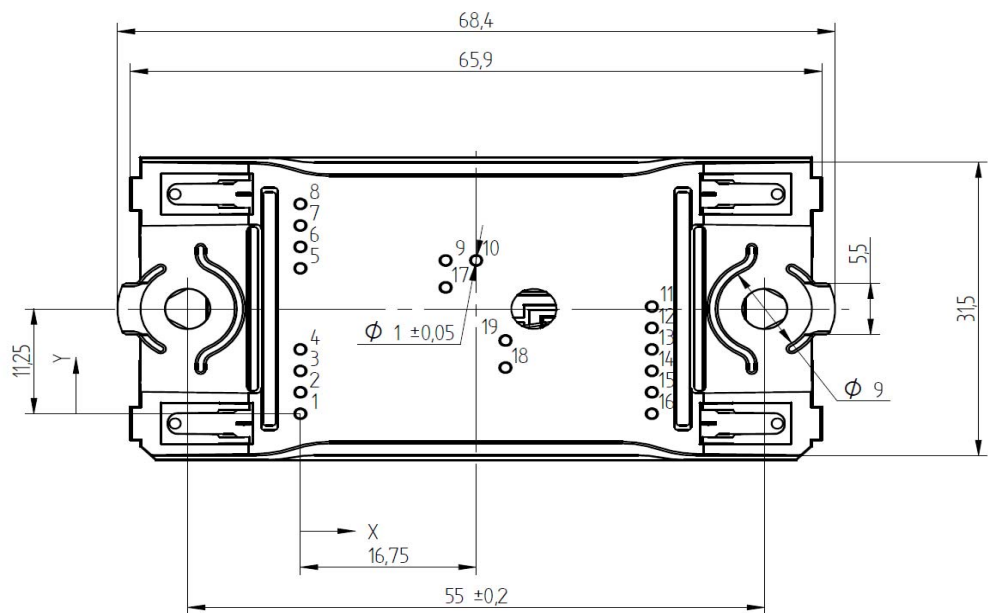

### Pinout

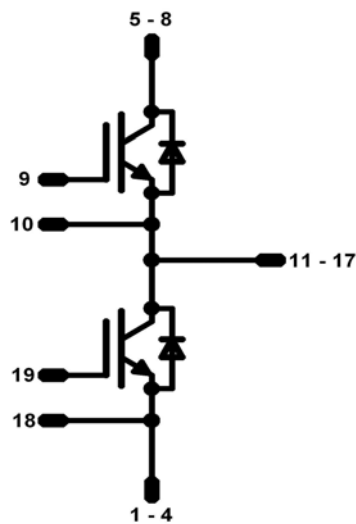

**PRODUCT STATUS DEFINITIONS**

Datasheet Status	Product Status	Definition
Target	Formative or In Design	This datasheet contains the design specifications for product development. Specifications may change in any manner without notice. The data contained is exclusively intended for technically trained staff.
Preliminary	First Production	This datasheet contains preliminary data, and supplementary data may be published at a later date. Vincotech reserves the right to make changes at any time without notice in order to improve design. The data contained is exclusively intended for technically trained staff.
Final	Full Production	This datasheet contains final specifications. Vincotech reserves the right to make changes at any time without notice in order to improve design. The data contained is exclusively intended for technically trained staff.

**DISCLAIMER**

The information given in this datasheet describes the type of component and does not represent assured characteristics. For tested values please contact Vincotech. Vincotech reserves the right to make changes without further notice to any products herein to improve reliability, function or design. Vincotech does not assume any liability arising out of the application or use of any product or circuit described herein; neither does it convey any license under its patent rights, nor the rights of others.

**LIFE SUPPORT POLICY**

Vincotech products are not authorised for use as critical components in life support devices or systems without the express written approval of Vincotech.

As used herein:

1. Life support devices or systems are devices or systems which, (a) are intended for surgical implant into the body, or (b) support or sustain life, or (c) whose failure to perform when properly used in accordance with instructions for use provided in labelling can be reasonably expected to result in significant injury to the user.
2. A critical component is any component of a life support device or system whose failure to perform can be reasonably expected to cause the failure of the life support device or system, or to affect its safety or effectiveness.