

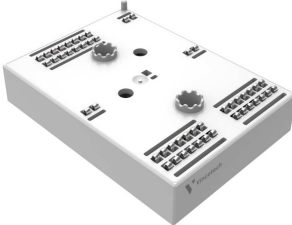
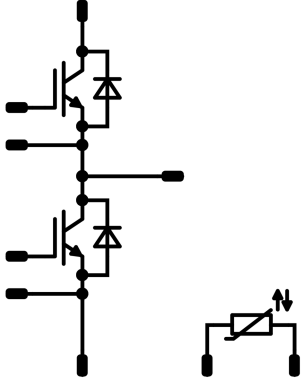

Vincotech

MiniSKiiP®DUAL 3	1200 V / 300 A
<div style="border: 1px solid black; padding: 5px; margin-bottom: 10px;"> <p style="text-align: center; background-color: #cccccc; margin: 0;">Features</p> <ul style="list-style-type: none"> IGBT M7 technology with low V_{CESat} and improved EMC behavior Solder-free spring contact technology Standard MiniSKiiP package sizes Built-in NTC </div> <div style="border: 1px solid black; padding: 5px; margin-bottom: 10px;"> <p style="text-align: center; background-color: #cccccc; margin: 0;">Target applications</p> <ul style="list-style-type: none"> Industrial Drives Power Supply Solar Inverters UPS </div> <div style="border: 1px solid black; padding: 5px;"> <p style="text-align: center; background-color: #cccccc; margin: 0;">Types</p> <ul style="list-style-type: none"> 80-M3122PA300M7-K839F70 </div>	<div style="border: 1px solid black; padding: 5px; margin-bottom: 10px;"> <p style="text-align: center; background-color: #cccccc; margin: 0;">MiniSKiiP®3 housing</p>  </div> <div style="border: 1px solid black; padding: 5px;"> <p style="text-align: center; background-color: #cccccc; margin: 0;">Schematic</p>  </div>

Maximum Ratings

$T_j = 25\text{ °C}$, unless otherwise specified

Parameter	Symbol	Condition	Value	Unit
Half-Bridge Switch				
Collector-emitter voltage	V_{CES}		1200	V
Collector current	I_C		300	A
Repetitive peak collector current	I_{CRM}	t_p limited by T_{jmax}	600	A
Total power dissipation	P_{tot}	$T_j = T_{jmax}$ $T_s = 80\text{ °C}$	722	W
Gate-emitter voltage	V_{GES}		±20	V
Short circuit ratings	t_{SC}	$V_{GE} = 15\text{ V}$ $V_{CE} = 800\text{ V}$ $T_j = 150\text{ °C}$	9,5	µs
Maximum junction temperature	T_{jmax}		175	°C



Vincotech

Maximum Ratings

$T_j = 25\text{ °C}$, unless otherwise specified

Parameter	Symbol	Condition	Value	Unit
Half-Bridge Diode				
Peak repetitive reverse voltage	V_{RRM}		1200	V
Continuous (direct) forward current	I_F	$T_j = T_{jmax}$ $T_s = 80\text{ °C}$	258	A
Repetitive peak forward current	I_{FRM}		600	A
Total power dissipation	P_{tot}	$T_j = T_{jmax}$ $T_s = 80\text{ °C}$	447	W
Maximum junction temperature	T_{jmax}		175	°C

Module Properties

Thermal Properties

Storage temperature	T_{stg}		-40...+125	°C
Operation temperature under switching condition	T_{top}		-40...($T_{jmax} - 25$)	°C

Isolation Properties

Isolation voltage	V_{isol}	DC Test Voltage* $t_p = 2\text{ s}$	5500	V
		AC Voltage $t_p = 1\text{ min}$	2500	V
Creepage distance		With std lid For more informations see handling instructions	6,3	mm
Clearance		With std lid For more informations see handling instructions	6,3	mm
Comparative Tracking Index	CTI		> 200	

*100 % tested in production



Vincotech

Characteristic Values

Parameter	Symbol	Conditions					Value			Unit
		V_{GE} [V] V_{GS} [V]	V_{CE} [V] V_{DS} [V] V_F [V]	I_C [A] I_D [A] I_F [A]	T_j [°C]	Min	Typ	Max		

Half-Bridge Switch

Static

Gate-emitter threshold voltage	$V_{GE(th)}$		10	0,03	25	5,4	6	6,6	V
Collector-emitter saturation voltage	V_{CEsat}	15		300	25 125 150		1,55 1,70 1,75	1,9	V
Collector-emitter cut-off current	I_{CES}	0	1200		25			400	μA
Gate-emitter leakage current	I_{GES}	20	0		25			2000	nA
Internal gate resistance	r_g						1		Ω
Input capacitance	C_{ies}						64000		pF
Output capacitance	C_{oes}	0	10		25		1920		
Reverse transfer capacitance	C_{res}						760		
Gate charge	Q_g	15	600	300	25		2280		nC

Thermal

Thermal resistance junction to sink	$R_{th(j-s)}$	$\lambda_{paste} = 2,5$ W/mK (HPTP)					0,13		K/W
-------------------------------------	---------------	--	--	--	--	--	------	--	-----

Dynamic

Turn-on delay time	$t_{d(on)}$				25 125 150		381 387 386		ns
Rise time	t_r	$R_{gon} = 2$ Ω $R_{goff} = 2$ Ω			25 125 150		48 56 59		
Turn-off delay time	$t_{d(off)}$		±15	600	300	25 125 150	331 365 372		
Fall time	t_f					25 125 150	78 93 103		
Turn-on energy (per pulse)	E_{on}	$Q_{tFWD} = 31,6$ μC $Q_{tFWD} = 48,5$ μC $Q_{tFWD} = 53,8$ μC				25 125 150	26,05 33,99 37,10		mWs
Turn-off energy (per pulse)	E_{off}					25 125 150	21,56 27,54 29,53		



Vincotech

Characteristic Values

Parameter	Symbol	Conditions					Value			Unit	
		V_{GE} [V] V_{GS} [V]	V_{CE} [V] V_{DS} [V] V_F [V]	I_C [A] I_D [A] I_F [A]	T_j [°C]	Min	Typ	Max			
Half-Bridge Diode											
Static											
Forward voltage	V_F			300	25 125 150		1,73 1,83 1,84	2,15		V	
Reverse leakage current	I_R		1200		25			220		μA	
Thermal											
Thermal resistance junction to sink	$R_{th(j-s)}$	$\lambda_{paste} = 2,5 \text{ W/mK}$ (HPTP)						0,21			K/W
Dynamic											
Peak recovery current	I_{RRM}				25 125 150		241 241 248			A	
Reverse recovery time	t_{rr}				25 125 150		323 467 507			ns	
Recovered charge	Q_r	$di/dt = 6099 \text{ A/}\mu\text{s}$ $di/dt = 5119 \text{ A/}\mu\text{s}$ $di/dt = 5338 \text{ A/}\mu\text{s}$	± 15	600	300	25 125 150	31,61 48,49 53,78			μC	
Reverse recovered energy	E_{rec}				25 125 150		11,27 17,91 19,96			mWs	
Peak rate of fall of recovery current	$(di_{rf}/dt)_{max}$				25 125 150		1525 1174 1151			A/μs	
Thermistor											
Rated resistance	R				25		5			kΩ	
Deviation of R_{100}	$\Delta_{R/R}$	$R_{100} = 493 \Omega$			100	-5		+5		%	
Power dissipation	P				25		245			mW	
Power dissipation constant					25		1,4			mW/K	
B-value	$B_{(25/50)}$	Tol. $\pm 2 \%$			25		3375			K	
B-value	$B_{(25/100)}$	Tol. $\pm 2 \%$			25		3437			K	
Vincotech NTC Reference									K		



Half-Bridge Switch Characteristics

figure 1. IGBT

Typical output characteristics

$$I_C = f(V_{CE})$$

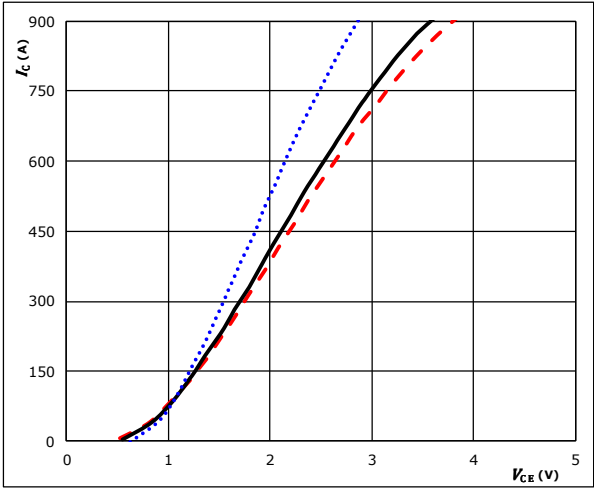

$t_p = 250 \mu s$
 $V_{CE} = 15 V$
 $T_j: 25 \text{ } ^\circ C$ (dotted blue)
 $125 \text{ } ^\circ C$ (solid black)
 $150 \text{ } ^\circ C$ (dashed red)

figure 2. IGBT

Typical output characteristics

$$I_C = f(V_{CE})$$

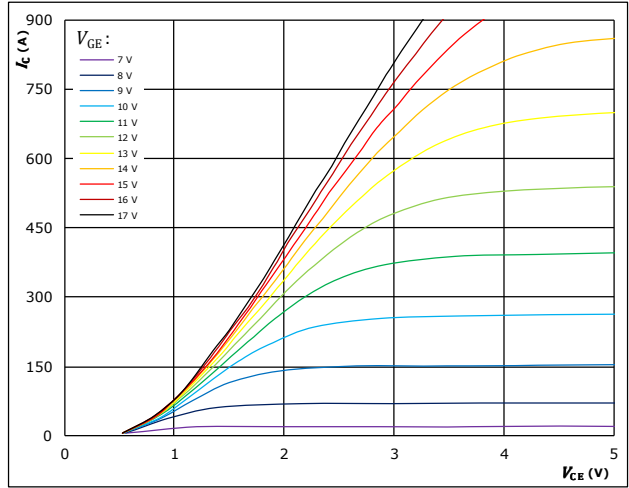

$t_p = 250 \mu s$
 $T_j = 150 \text{ } ^\circ C$
 V_{GE} from 7 V to 17 V in steps of 1 V

figure 3. IGBT

Typical transfer characteristics

$$I_C = f(V_{GE})$$

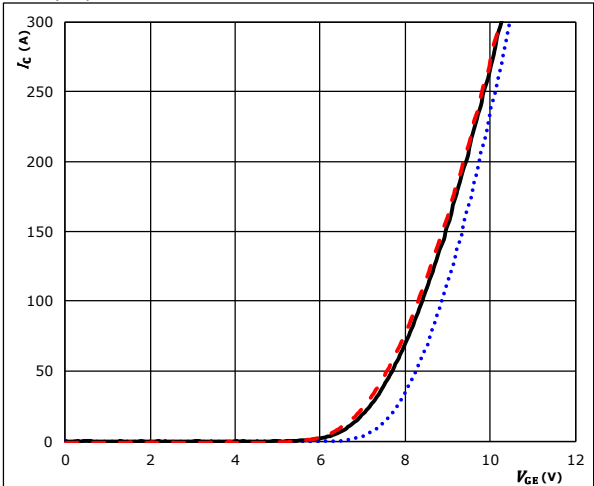

$t_p = 100 \mu s$
 $V_{CE} = 10 V$
 $T_j: 25 \text{ } ^\circ C$ (dotted blue)
 $125 \text{ } ^\circ C$ (solid black)
 $150 \text{ } ^\circ C$ (dashed red)

figure 4. IGBT

Transient thermal impedance as function of pulse duration

$$Z_{th(j-s)} = f(t_p)$$

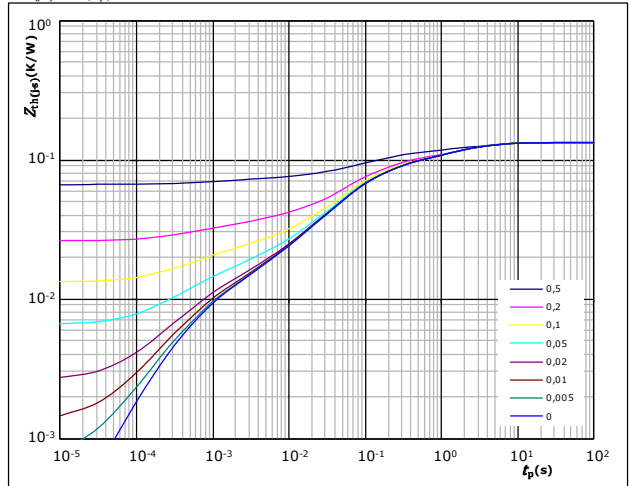

$D = t_p / T$
 $R_{th(j-s)} = 0,13 \text{ K/W}$

IGBT thermal model values

R (K/W)	τ (s)
3,61E-02	1,83E+00
2,63E-02	2,40E-01
5,03E-02	5,34E-02
8,46E-03	7,56E-03
5,96E-03	1,02E-03
4,50E-03	2,62E-04



Vincotech

Half-Bridge Switch Characteristics

figure 5. IGBT

Safe operating area

$$I_C = f(V_{CE})$$

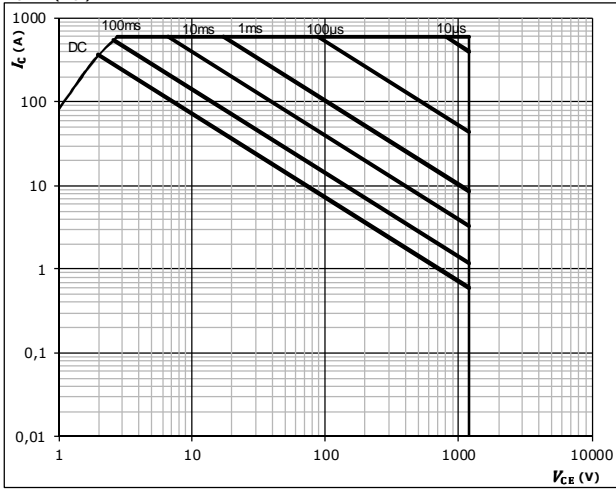

$D =$ single pulse
 $T_s = 80$ °C
 $V_{GE} = \pm 15$ V
 $T_j = T_{jmax}$



Half-Bridge Diode Characteristics

figure 1. FWD

Typical forward characteristics

$$I_F = f(V_F)$$

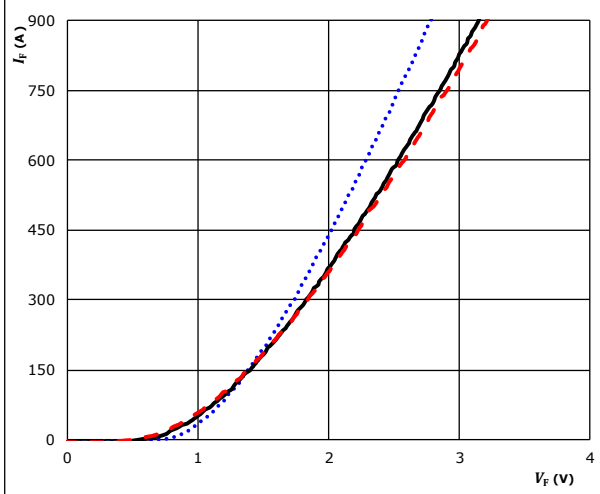

$t_p = 250 \mu s$
 T_j : 25 °C
 125 °C ———
 150 °C - - - -

figure 2. FWD

Transient thermal impedance as a function of pulse width

$$Z_{th(j-s)} = f(t_p)$$

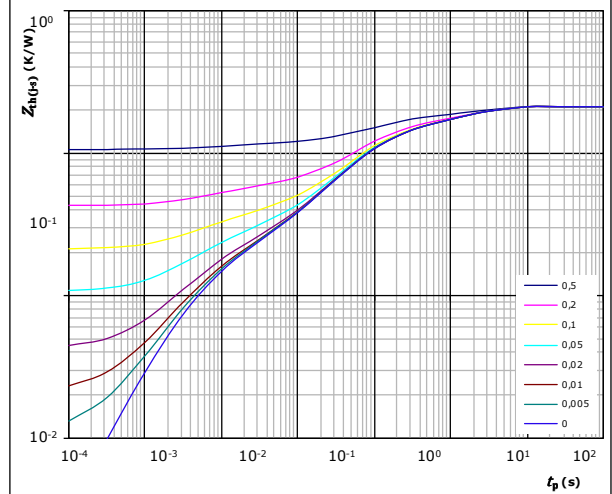

$D = t_p / T$
 $R_{th(j-s)} = 0,21 \text{ K/W}$
 FWD thermal model values

R (K/W)	τ (s)
5,84E-02	2,95E+00
4,24E-02	3,87E-01
8,13E-02	8,62E-02
1,37E-02	1,22E-02
9,63E-03	1,64E-03
7,27E-03	4,23E-04

Thermistor Characteristics

figure 1. Thermistor

Typical NTC characteristic
as a function of temperature

$$R = f(T)$$

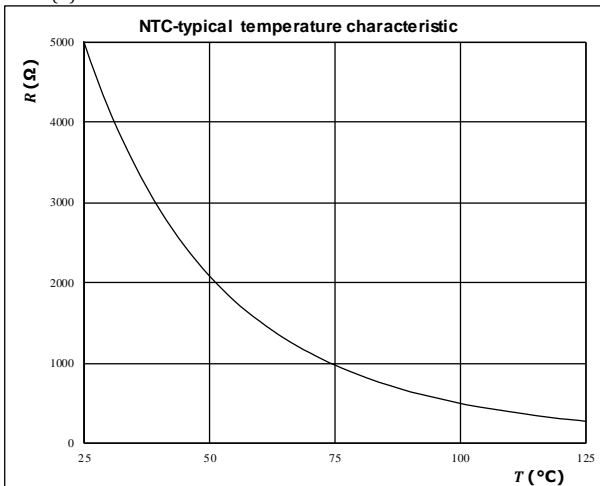



Half-Bridge Switching Characteristics

figure 1. IGBT
Typical switching energy losses as a function of collector current

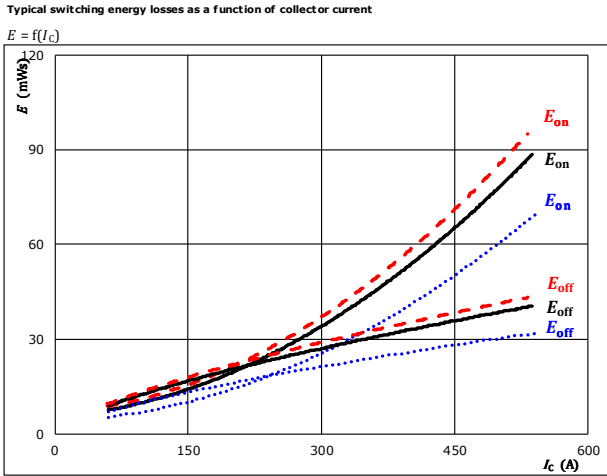

With an inductive load at

$V_{CE} = 600$ V	$T_j:$ 25 °C
$V_{GE} = \pm 15$ V	125 °C	————
$R_{\theta on} = 2$ Ω	150 °C	- - - -
$R_{\theta off} = 2$ Ω		

figure 2. IGBT
Typical switching energy losses as a function of gate resistor

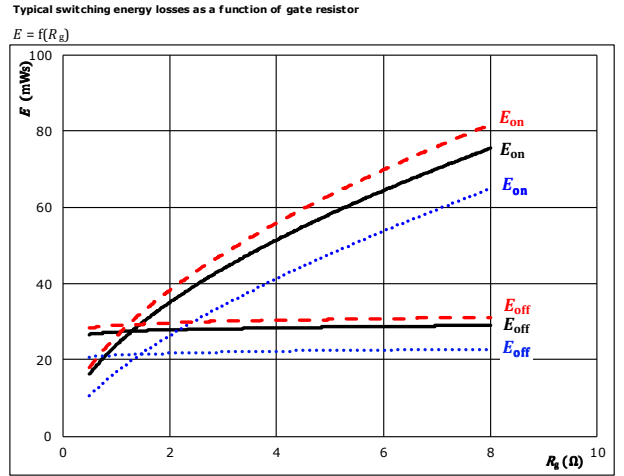

With an inductive load at

$V_{CE} = 600$ V	$T_j:$ 25 °C
$V_{GE} = \pm 15$ V	125 °C	————
$I_C = 300$ A	150 °C	- - - -

figure 3. FWD
Typical reverse recovered energy loss as a function of collector current

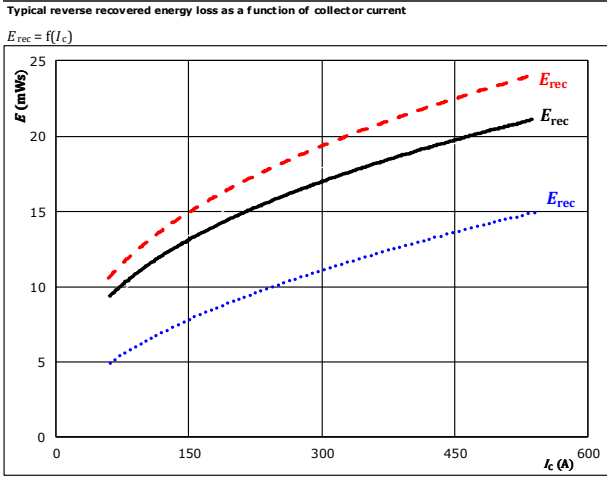

With an inductive load at

$V_{CE} = 600$ V	$T_j:$ 25 °C
$V_{GE} = \pm 15$ V	125 °C	————
$R_{\theta on} = 2$ Ω	150 °C	- - - -

figure 4. FWD
Typical reverse recovered energy loss as a function of gate resistor

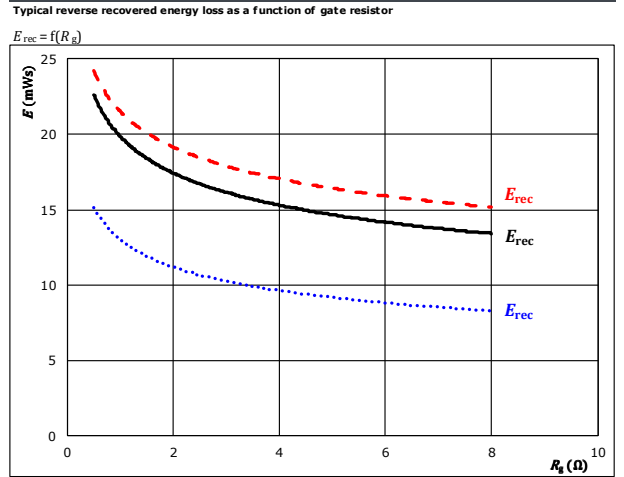

With an inductive load at

$V_{CE} = 600$ V	$T_j:$ 25 °C
$V_{GE} = \pm 15$ V	125 °C	————
$I_C = 300$ A	150 °C	- - - -



Half-Bridge Switching Characteristics

figure 5. IGBT

Typical switching times as a function of collector current

$$t = f(I_C)$$

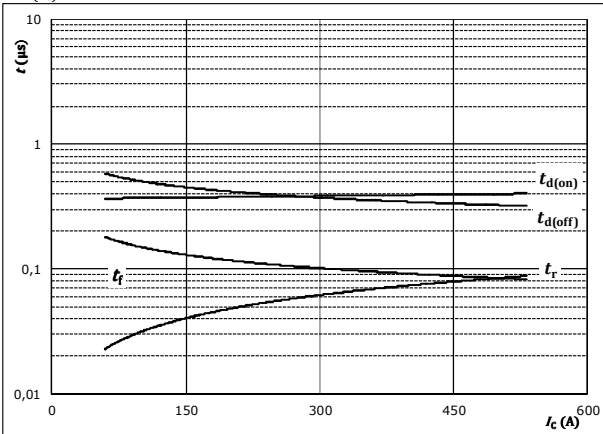

With an inductive load at

$T_j =$	150	°C
$V_{CE} =$	600	V
$V_{GE} =$	±15	V
$R_{g(on)} =$	2	Ω
$R_{g(off)} =$	2	Ω

figure 6. IGBT

Typical switching times as a function of gate resistor

$$t = f(R_g)$$

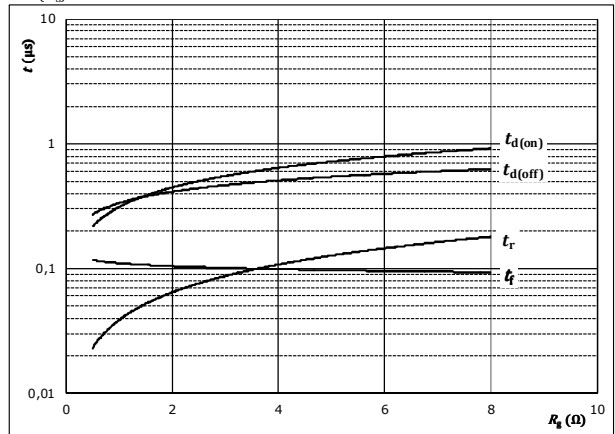

With an inductive load at

$T_j =$	150	°C
$V_{CE} =$	600	V
$V_{GE} =$	±15	V
$I_C =$	300	A

figure 7. FWD

Typical reverse recovery time as a function of collector current

$$t_{rr} = f(I_C)$$

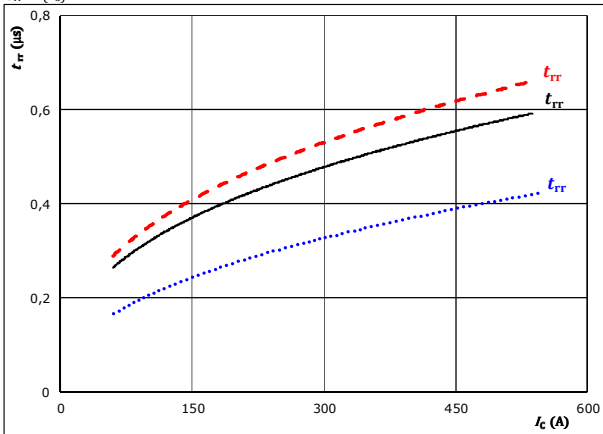

With an inductive load at

$V_{CE} =$	600	V	$T_j:$	25 °C
$V_{GE} =$	±15	V		125 °C	————
$R_{g(on)} =$	2	Ω		150 °C	-----

figure 8. FWD

Typical reverse recovery time as a function of IGBT turn on gate resistor

$$t_{rr} = f(R_{g(on)})$$

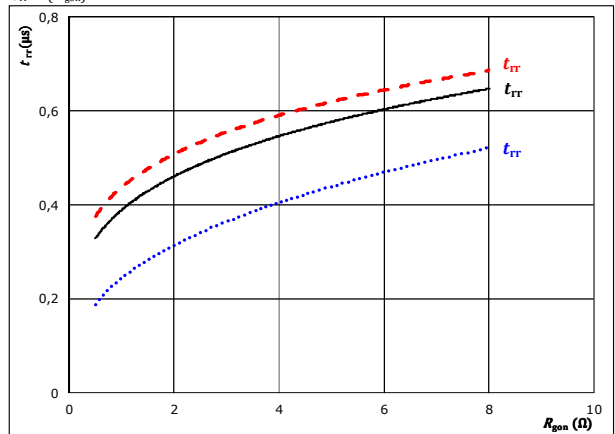

With an inductive load at

$V_{CE} =$	600	V	$T_j:$	25 °C
$V_{GE} =$	±15	V		125 °C	————
$I_C =$	300	A		150 °C	-----



Half-Bridge Switching Characteristics

figure 9. FWD
Typical recovered charge as a function of collector current

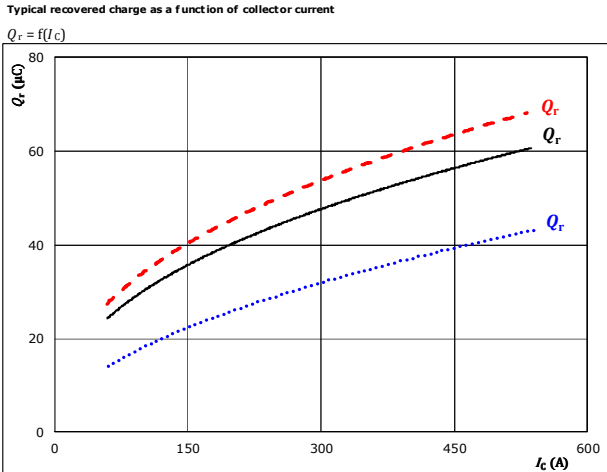

With an inductive load at

$V_{CE} = 600$ V	$T_j = 25$ °C
$V_{GE} = \pm 15$ V	$T_j = 125$ °C	————
$R_{gpn} = 2$ Ω	$T_j = 150$ °C	-----

figure 10. FWD
Typical recovered charge as a function of IGBT turn on gate resistor

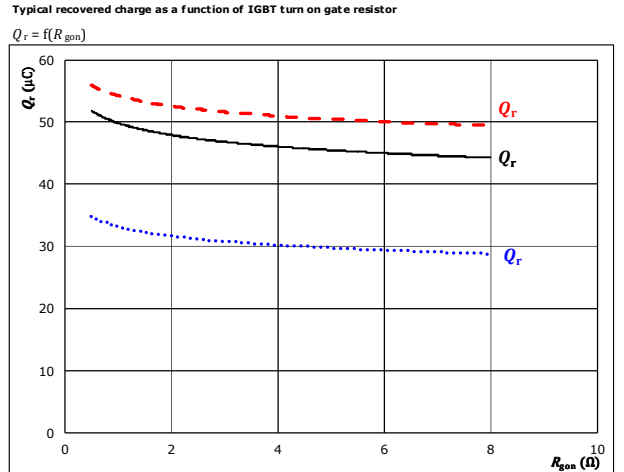

With an inductive load at

$V_{CE} = 600$ V	$T_j = 25$ °C
$V_{GE} = \pm 15$ V	$T_j = 125$ °C	————
$I_c = 300$ A	$T_j = 150$ °C	-----

figure 11. FWD
Typical peak reverse recovery current current as a function of collector current

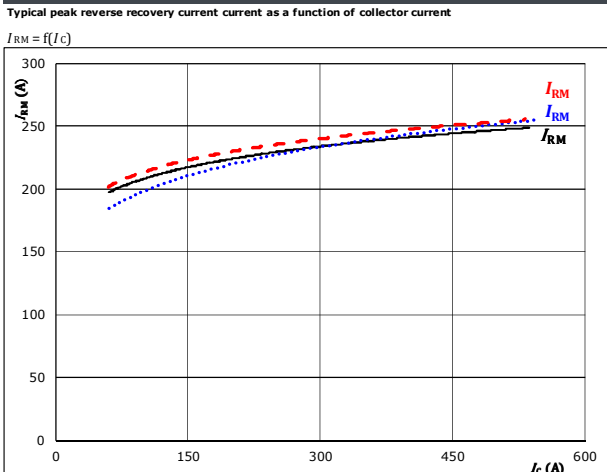

With an inductive load at

$V_{CE} = 600$ V	$T_j = 25$ °C
$V_{GE} = \pm 15$ V	$T_j = 125$ °C	————
$R_{gpn} = 2$ Ω	$T_j = 150$ °C	-----

figure 12. FWD
Typical peak reverse recovery current as a function of IGBT turn on gate resistor

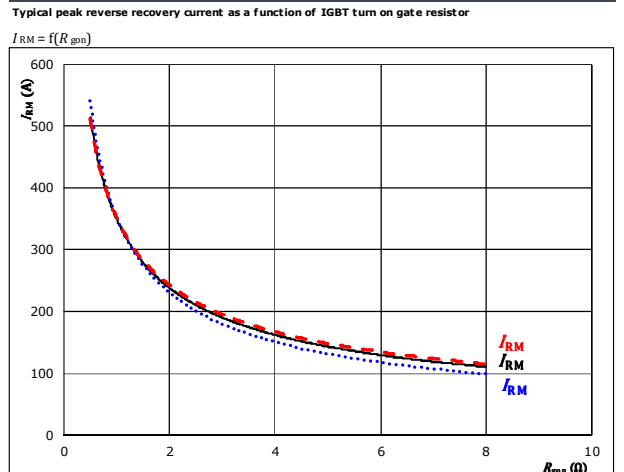

With an inductive load at

$V_{CE} = 600$ V	$T_j = 25$ °C
$V_{GE} = \pm 15$ V	$T_j = 125$ °C	————
$I_c = 300$ A	$T_j = 150$ °C	-----



Half-Bridge Switching Characteristics

figure 13. FWD

Typical rate of fall of forward and reverse recovery current as a function of collector current
 $di_f/dt, di_{rr}/dt = f(I_c)$

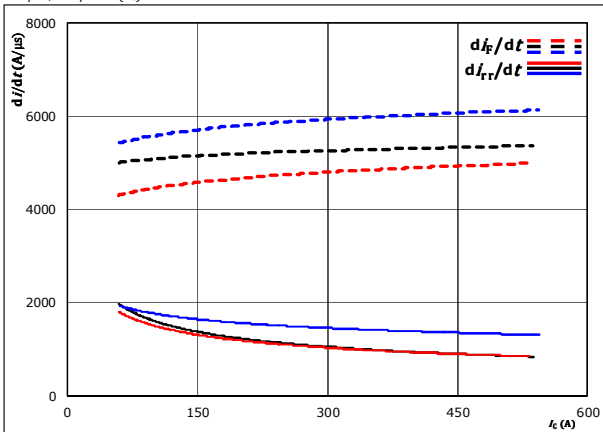

With an inductive load at
 $V_{CE} = 600$ V
 $V_{GE} = \pm 15$ V
 $R_{g(on)} = 2$ Ω
 $T_j = 25$ °C
 125 °C
 150 °C

figure 14. FWD

Typical rate of fall of forward and reverse recovery current as a function of IGBT turn on gate resistor
 $di_f/dt, di_{rr}/dt = f(R_{g(on)})$

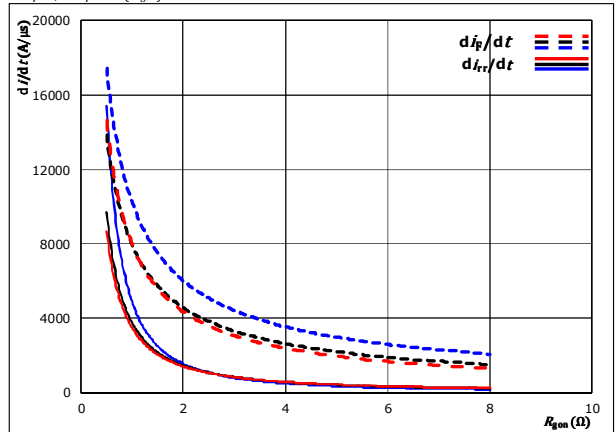

With an inductive load at
 $V_{CE} = 600$ V
 $V_{GE} = \pm 15$ V
 $I_C = 300$ A
 $T_j = 25$ °C
 125 °C
 150 °C

figure 15. IGBT

Reverse bias safe operating area
 $I_C = f(V_{CE})$

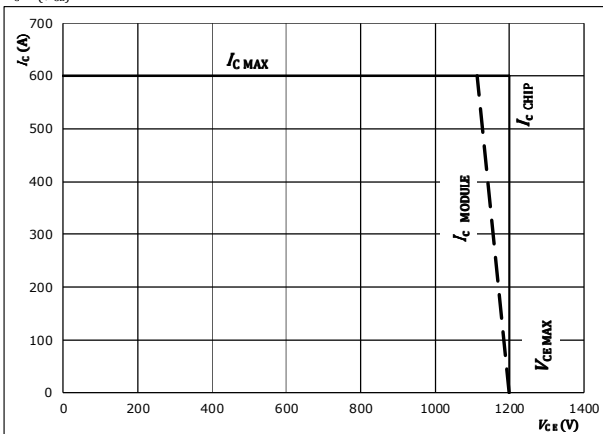

At
 $T_j = 125$ °C
 $R_{g(on)} = 2$ Ω
 $R_{g(off)} = 2$ Ω



Half-Bridge Switching Definitions

General conditions

T_j	=	125 °C
R_{gon}	=	2 Ω
R_{goff}	=	2 Ω

figure 1. IGBT

Turn-off Switching Waveforms & definition of t_{doff} , t_{Eoff} (t_{Eoff} = integrating time for E_{off})

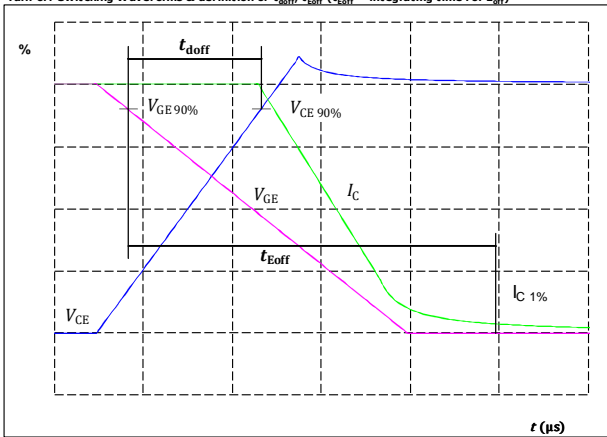

$V_{CE}(0\%) =$	-15	V
$V_{GE}(100\%) =$	15	V
$V_C(100\%) =$	600	V
$I_C(100\%) =$	300	A
$t_{doff} =$	365	ns

figure 2. IGBT

Turn-on Switching Waveforms & definition of t_{don} , t_{Eon} (t_{Eon} = integrating time for E_{on})

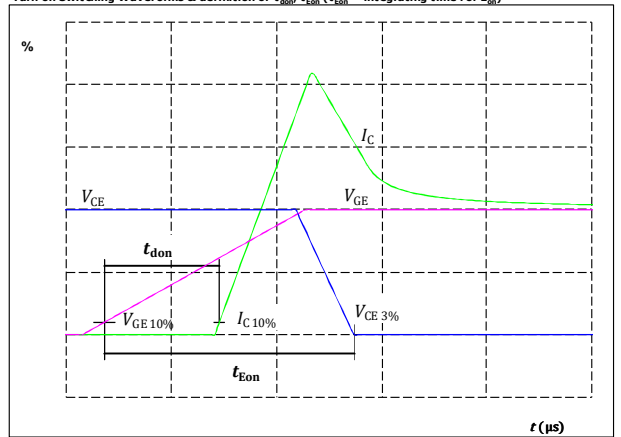

$V_{CE}(0\%) =$	-15	V
$V_{GE}(100\%) =$	15	V
$V_C(100\%) =$	600	V
$I_C(100\%) =$	300	A
$t_{don} =$	387	ns

figure 3. IGBT

Turn-off Switching Waveforms & definition of t_f

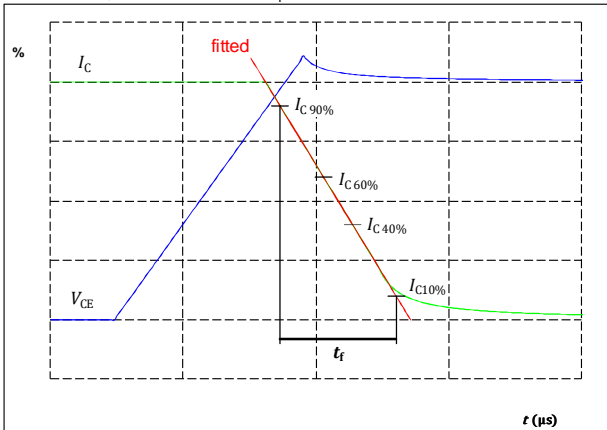

$V_C(100\%) =$	600	V
$I_C(100\%) =$	300	A
$t_f =$	93	ns

figure 4. IGBT

Turn-on Switching Waveforms & definition of t_r

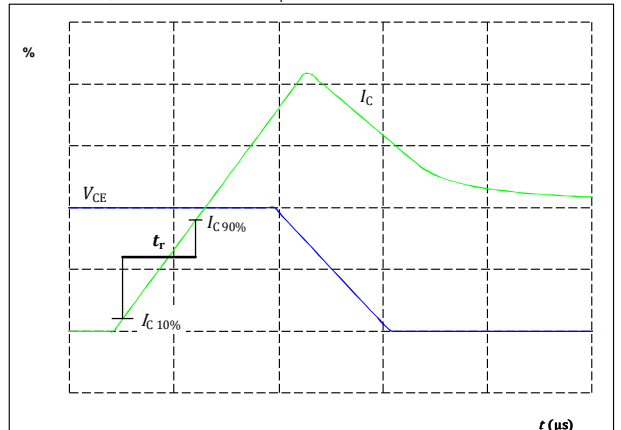

$V_C(100\%) =$	600	V
$I_C(100\%) =$	300	A
$t_r =$	56	ns



Vincotech

Half-Bridge Switching Characteristics

figure 5. FWD
Turn-off Switching Waveforms & definition of t_{rr}

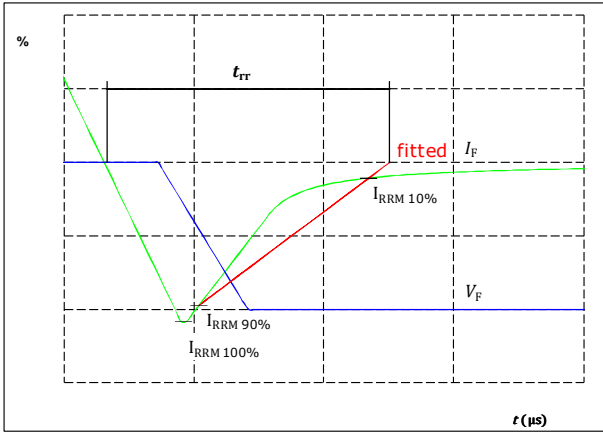

$V_F(100\%) =$	600	V
$I_F(100\%) =$	300	A
$I_{RRM}(100\%) =$	241	A
$t_{rr} =$	467	ns

figure 6. FWD
Turn-on Switching Waveforms & definition of t_{Qr} ($t_{Qr} =$ integrating time for Q_r)

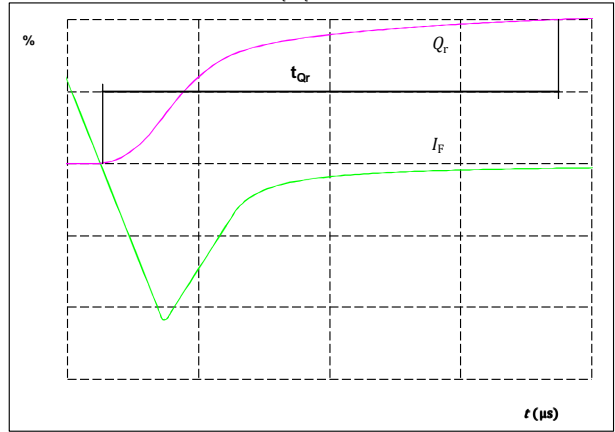

$I_F(100\%) =$	300	A
$Q_r(100\%) =$	48,49	μC



Vincotech

Ordering Code & Marking							
Version			Ordering Code				
With std lid (6.5mm height) + no thermal grease			80-M3122PA300M7-K839F70-/0A/				
With thin lid (2.8mm height) + no thermal grease			80-M3122PA300M7-K839F70-/0B/				
With std lid (6.5mm height) + thermal grease (0,8 W/mK, P12, silicone-based)			80-M3122PA300M7-K839F70-/1A/				
With thin lid (2.8mm height) + thermal grease (0,8 W/mK, P12, silicone-based)			80-M3122PA300M7-K839F70-/1B/				
With std lid (6.5mm height) + thermal grease (2,5 W/mK, TG20032, silicone-free)			80-M3122PA300M7-K839F70-/4A/				
With thin lid (2.8mm height) + thermal grease (2,5 W/mK, TG20032, silicone-free)			80-M3122PA300M7-K839F70-/4B/				
With std lid (6.5mm height) + thermal grease (2,5 W/mK, HPTP, silicone-based)			80-M3122PA300M7-K839F70-/5A/				
With thin lid (2.8mm height) + thermal grease (2,5 W/mK, HPTP, silicone-based)			80-M3122PA300M7-K839F70-/5B/				
	Text	Name		Date code	UL & VIN	Lot	Serial
		NN-NNNNNNNNNNNNNN-TTTTTWW		WWYY	UL VIN	LLLLL	SSSS
		Datamatrix	Type&Ver	Lot number	Serial	Date code	
		TTTTTWW	LLLLL	SSSS	WWYY		

Outline							
PCB pad table				PCB pad table			
Pin	X	Y	Function	Pin	X	Y	Function
1	-53,95	-17,8	Ph	48	13,95	15,4	+DC
2	-53,95	-14,6	Ph	49	13,95	18,6	+DC
3	-53,95	-11,4	Ph	50	13,95	21,8	+DC
4	-53,95	-8,2	Ph	51	13,95	25	+DC
5	-53,95	-5	Ph				
6	-53,95	-1,8	Ph				
7	-53,95	1,4	Ph				
8	-53,95	4,6	Ph				
9	-49,95	-17,8	Ph				
10	-49,95	-14,6	Ph				
11	-49,95	-11,4	Ph				
12	-49,95	-8,2	Ph				
13	-49,95	-5	Ph				
14	-49,95	-1,8	Ph				
15	-49,95	1,4	Ph				
16	-49,95	4,6	Ph				
17	-51,75	21,8	Therm1				
18	-51,75	25,4	Therm2				
19	-20,25	-25,4	G11				
20	-20,25	-22	S11				
21	Not assembled						
22	-20,15	21,8	S12				
23	-20,15	25,4	G12				
24	9,95	-25	-DC				
25	9,95	-21,8	-DC				
26	9,95	-18,6	-DC				
27	9,95	-15,4	-DC				
28	9,95	-12,2	-DC				
29	9,95	-9	-DC				
30	9,95	-5,8	-DC				
31	13,95	-25	-DC				
32	13,95	-21,8	-DC				
33	13,95	-18,6	-DC				
34	13,95	-15,4	-DC				
35	13,95	-12,2	-DC				
36	13,95	-9	-DC				
37	13,95	-5,8	-DC				
38	9,95	5,8	+DC				
39	9,95	9	+DC				
40	9,95	12,2	+DC				
41	9,95	15,4	+DC				
42	9,95	18,6	+DC				
43	9,95	21,8	+DC				
44	9,95	25	+DC				
45	13,95	5,8	+DC				
46	13,95	9	+DC				
47	13,95	12,2	+DC				

Pad positions refers to center point. For more informations on pad design please see package data



Vincotech

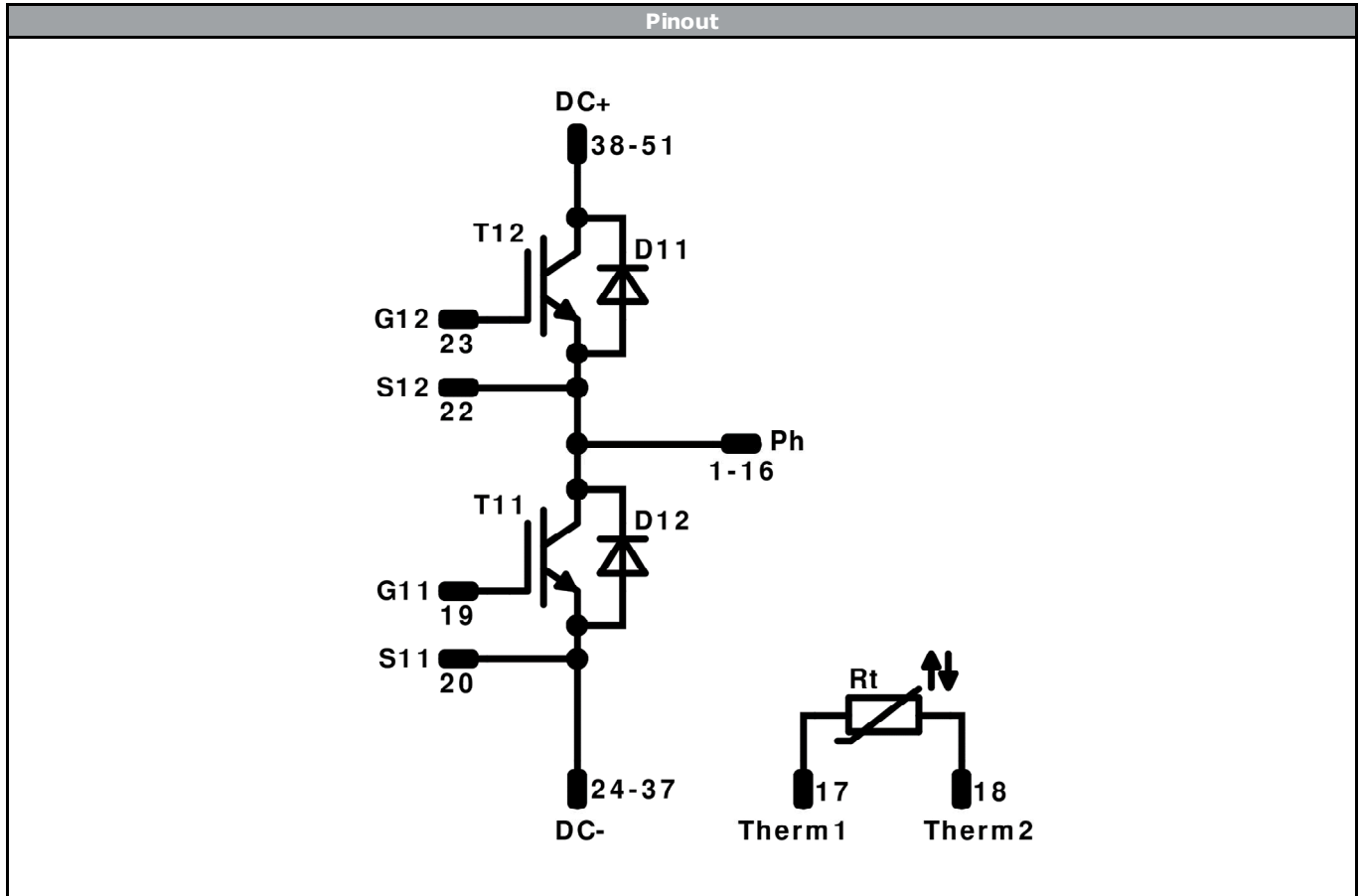

Identification					
ID	Component	Voltage	Current	Function	Comment
T11, T12	IGBT	1200 V	300 A	Half-Bridge Switch	
D11, D12	FWD	1200 V	300 A	Half-Bridge Diode	
Rt	NTC			Thermistor	



Vincotech

Packaging instruction			
Standard packaging quantity (SPQ) 48	>SPQ	Standard	<SPQ Sample

Handling instruction
Handling instructions for MiniSkiiP® 3 packages see vincotech.com website.

Package data
Package data for MiniSkiiP® 3 packages see vincotech.com website.

UL recognition and file number
This device is certified according to UL 1557 standard, UL file number E192116. For more information see vincotech.com website. 

Document No.:	Date:	Modification:	Pages
80-M3122PA300M7-K839F70-D1-14	08 Nov. 2018		

DISCLAIMER

The information, specifications, procedures, methods and recommendations herein (together "information") are presented by Vincotech to reader in good faith, are believed to be accurate and reliable, but may well be incomplete and/or not applicable to all conditions or situations that may exist or occur. Vincotech reserves the right to make any changes without further notice to any products to improve reliability, function or design. No representation, guarantee or warranty is made to reader as to the accuracy, reliability or completeness of said information or that the application or use of any of the same will avoid hazards, accidents, losses, damages or injury of any kind to persons or property or that the same will not infringe third parties rights or give desired results. It is reader's sole responsibility to test and determine the suitability of the information and the product for reader's intended use.

LIFE SUPPORT POLICY

Vincotech products are not authorised for use as critical components in life support devices or systems without the express written approval of Vincotech.

As used herein:

1. Life support devices or systems are devices or systems which, (a) are intended for surgical implant into the body, or (b) support or sustain life, or (c) whose failure to perform when properly used in accordance with instructions for use provided in labelling can be reasonably expected to result in significant injury to the user.
2. A critical component is any component of a life support device or system whose failure to perform can be reasonably expected to cause the failure of the life support device or system, or to affect its safety or effectiveness.