

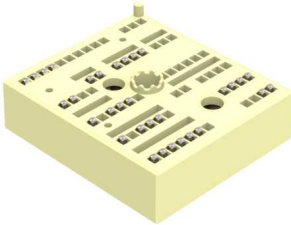
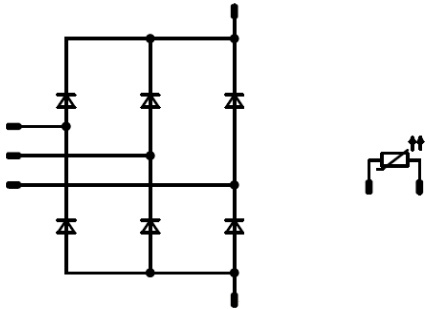

Vincotech

MiniSkiiP [®] CON 2	1600 V / 75 A
<div style="background-color: #eee; padding: 2px; margin-bottom: 5px;">Features</div> <ul style="list-style-type: none"> 3-phase rectifier Thermal sensor integrated 	<div style="background-color: #eee; padding: 2px; margin-bottom: 5px;">MiniSkiiP[®] 2 housing</div> 
<div style="background-color: #eee; padding: 2px; margin-bottom: 5px;">Target applications</div> <ul style="list-style-type: none"> Industrial Drives 	<div style="background-color: #eee; padding: 2px; margin-bottom: 5px;">Schematic</div> 
<div style="background-color: #eee; padding: 2px; margin-bottom: 5px;">Types</div> <ul style="list-style-type: none"> 80-M2166RA075RS-K738H 	

Maximum Ratings

$T_j = 25\text{ °C}$, unless otherwise specified

Parameter	Symbol	Condition	Value	Unit
Rectifier Diode				
Peak Repetitive Reverse Voltage	V_{RRM}		1600	V
Continuous (direct) forward current	I_F	$T_j = T_{jmax}$ $T_s = 80\text{ °C}$	99	A
Surge (non-repetitive) forward current	I_{FSM}	$t_p = 10\text{ ms, sin } 180^\circ$ $T_j = 150\text{ °C}$	890	A
Surge current capability	I^2t		3960	A ² s
Total power dissipation	P_{tot}	$T_j = T_{jmax}$ $T_s = 80\text{ °C}$	99	W
Maximum Junction Temperature	T_{jmax}		150	°C



Vincotech

Maximum Ratings

$T_j = 25\text{ °C}$, unless otherwise specified

Parameter	Symbol	Condition	Value	Unit
-----------	--------	-----------	-------	------

Module Properties

Thermal Properties

Storage temperature	T_{stg}		-40...+125	°C
Operation temperature under switching condition	T_{jop}		-40...(T _{jmax} - 25)	°C

Isolation Properties

Isolation voltage	V_{isol}	DC Test Voltage $t_p = 2\text{ s}$	4000	V
Creepage distance			min. 12,7	mm
Clearance			min. 12,7	mm
Comparative Tracking Index	CTI		> 200	



Vincotech

Characteristic Values

Parameter	Symbol	Conditions					Value			Unit
		V_{GE} [V] V_{GS} [V]	V_{CE} [V] V_{DS} [V] V_F [V]	I_C [A] I_D [A] I_F [A]	T_j [°C]	Min	Typ	Max		

Rectifier Diode

Static

Forward voltage	V_F			75	25 125		1,10 1,05	1,8	V
Reverse leakage current	I_r		1600		25 145			50 1100	μ A

Thermal

Thermal resistance junction to sink	$R_{th(j-s)}$	Thermal grease thickness $\leq 50\mu$ m $\lambda = 1$ W/mK					0,72		K/W
-------------------------------------	---------------	---	--	--	--	--	------	--	-----

Thermistor

Rated resistance	R				25		1		k Ω
Deviation of R_{100}	$\Delta_{R/R}$	$R_{100} = 1670 \Omega$			100	-2		+2	%
R_{100}	R				100		1670		Ω
Power dissipation constant					25		0,76		mW/K
A-value	$A_{(25/50)}$				25		$7,635 \cdot 10^{-3}$		1/K
B-value	$B_{(25/100)}$				25		$1,731 \cdot 10^{-5}$		1/K ²
Vincotech PTC Reference								E	



Vincotech

Rectifier Diode Characteristics

figure 1. Rectifier Diode
Typical forward characteristics

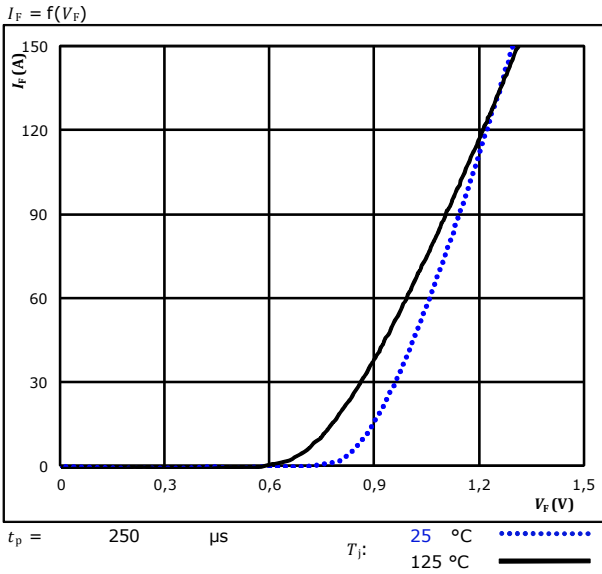
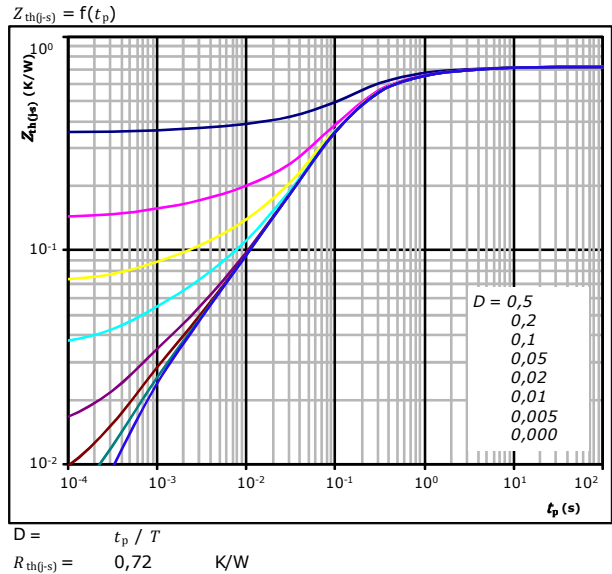

figure 2. Rectifier Diode
Transient thermal impedance as a function of pulse width



Diode thermal model values

R (K/W)	τ (s)
3,58E-02	5,02E+00
9,43E-02	9,66E-01
3,27E-01	1,91E-01
2,03E-01	6,81E-02
3,79E-02	6,02E-03
1,79E-02	7,71E-04



Vincotech

Thermistor Characteristics

figure 1. Thermistor

Typical PTC characteristic
as a function of temperature

$$R = f(T)$$

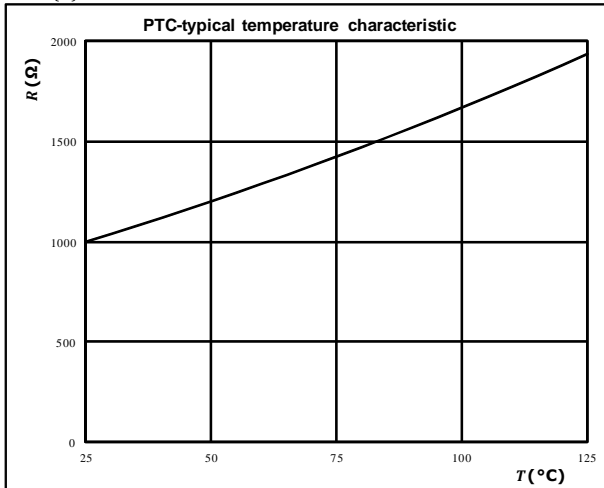



Vincotech

Ordering Code & Marking						
Version				Ordering Code		
with std lid (black V23990-K22-T-2-PM) without thermal paste				80-M2166RA075RS-K738H-/0A/		
						
Text	Name		Date code	UL & VIN	Lot	Serial
	NN-NNNNNNNNNNNNNN-TTTTTWW		WWYY	UL VIN	LLLLL	SSSS
	Datamatrix	Type&Ver	Lot number	Serial	Date code	
	TTTTTTTV	LLLLL	SSSS	WWYY		

Outline							
Pin table [mm]				Pin table [mm]			
Pin	X	Y	Function	Pin	X	Y	Function
1	24,38	-21,8	ACIn3	34			Not assembled
2	24,38	-18,6	ACIn3	35			Not assembled
3	24,38	-15,4	ACIn3	36			Not assembled
4	24,38	-12,2	ACIn3	37			Not assembled
5	24,38	-9	ACIn3	38			Not assembled
6	24,38	-5,8	ACIn3	39			Not assembled
7			Not assembled	40	-8,5	-21,8	DC-Rect
8			Not assembled	41	-8,5	-18,6	DC-Rect
9			Not assembled	42			Not assembled
10	24,38	18,6	DC+	43			Not assembled
11	24,38	21,8	DC+	44	-12,22	-9	ACIn1
12	16,58	12,2	DC+	45	-12,22	-5,8	ACIn1
13	16,58	15,4	DC+	46	-12,22	0,7	ACIn1
14	16,58	18,6	DC+	47	-12,22	3,9	ACIn1
15	16,58	21,8	DC+	48	-12,22	7,1	ACIn1
16	13,42	-21,8	Therm1	49	-12,22	10,3	ACIn1
17			Not assembled	50			Not assembled
18	13,42	-15,4	ACIn2	51			Not assembled
19	13,42	-12,2	ACIn2	52			Not assembled
20	13,42	-9	ACIn2	53	-24,38	-21,8	DC-Rect
21			Not assembled	54	-24,38	-18,6	DC-Rect
22			Not assembled	55	-24,38	-15,4	DC-Rect
23			Not assembled	56	-24,38	-12,2	DC-Rect
24			Not assembled	57			Not assembled
25			Not assembled	58			Not assembled
26			Not assembled	59			Not assembled
27			Not assembled	60			Not assembled
28	2,46	-21,8	Therm2	61			Not assembled
29			Not assembled	62			Not assembled
30	2,46	-15,4	ACIn2	63			Not assembled
31	2,46	-12,2	ACIn2	64			Not assembled
32	2,46	-9	ACIn2	65			Not assembled
33			Not assembled				

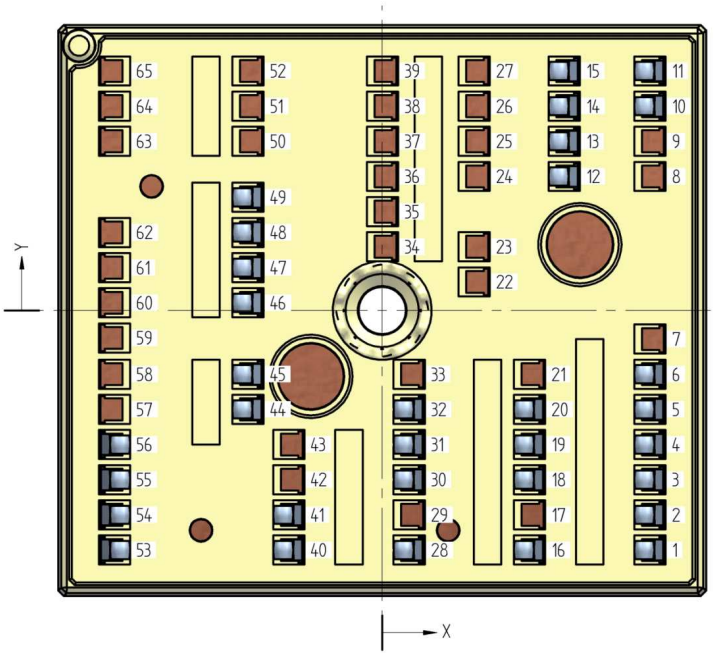

mid. Of BCB pads are dimensioned



Vincotech

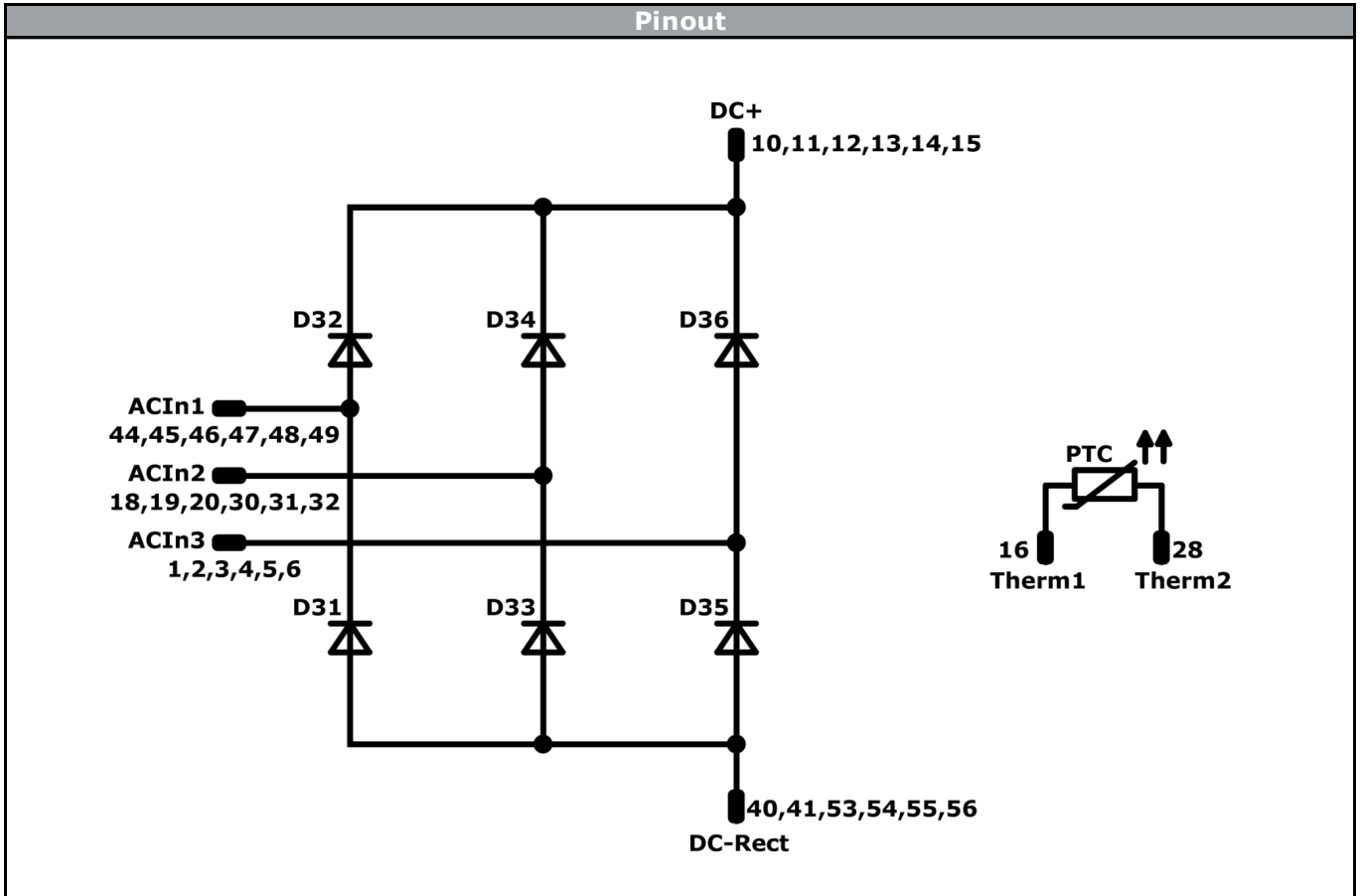

Identification					
ID	Component	Voltage	Current	Function	Comment
D31-D36	FWD	1600 V	75 A	Rectifier Diode	
PTC	Thermistor			Thermistor	



Vincotech

Packaging instruction			
Standard packaging quantity (SPQ) 72	>SPQ	Standard	<SPQ Sample

Handling instruction
Handling instructions for MiniSkiiP® 2 packages see vincotech.com website.

Package data
Package data for MiniSkiiP® 2 packages see vincotech.com website.

UL recognition and file number
This device is certified according to UL 1557 standard, UL file number E192116. For more information see vincotech.com website. 

Document No.:	Date:	Modification:	Pages
80-M2166RA075RS-K738H-D2-14	06 Mar. 2017	Thermal condition correction	3

DISCLAIMER

The information, specifications, procedures, methods and recommendations herein (together "information") are presented by Vincotech to reader in good faith, are believed to be accurate and reliable, but may well be incomplete and/or not applicable to all conditions or situations that may exist or occur. Vincotech reserves the right to make any changes without further notice to any products to improve reliability, function or design. No representation, guarantee or warranty is made to reader as to the accuracy, reliability or completeness of said information or that the application or use of any of the same will avoid hazards, accidents, losses, damages or injury of any kind to persons or property or that the same will not infringe third parties rights or give desired results. It is reader's sole responsibility to test and determine the suitability of the information and the product for reader's intended use.

LIFE SUPPORT POLICY

Vincotech products are not authorised for use as critical components in life support devices or systems without the express written approval of Vincotech.

As used herein:

1. Life support devices or systems are devices or systems which, (a) are intended for surgical implant into the body, or (b) support or sustain life, or (c) whose failure to perform when properly used in accordance with instructions for use provided in labelling can be reasonably expected to result in significant injury to the user.
2. A critical component is any component of a life support device or system whose failure to perform can be reasonably expected to cause the failure of the life support device or system, or to affect its safety or effectiveness.