

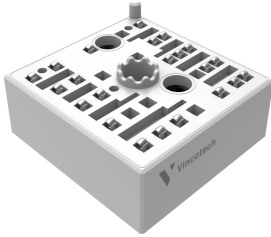

MiniSKiiP PACK 1		1200 V / 35 A	
Topology features <ul style="list-style-type: none">• Inverter• Open Emitter configuration• Temperature sensor		MiniSKiiP® 1 16 mm housing 	
Component features <ul style="list-style-type: none">• Easy paralleling• Low turn-off losses• Low collector emitter saturation voltage• Positive temperature coefficient• Short tail current• Switching optimized for EMC			
Housing features <ul style="list-style-type: none">• Base isolation: Al₂O₃• Easy assembly in one mounting step• Flexible PCB design w/o pin holes• Rugged solderless spring contacts			
Target applications <ul style="list-style-type: none">• Industrial Drives			
Types <ul style="list-style-type: none">• 80-M1126PA035M7-K210F70			
		Schematic 	

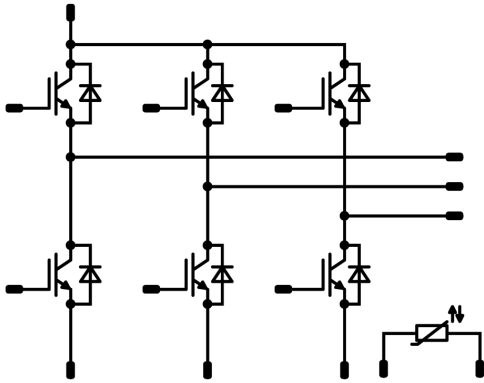

Maximum Ratings

 $T_j = 25\text{ °C}$, unless otherwise specified

Parameter	Symbol	Conditions	Value	Unit
Inverter Switch				
Collector-emitter voltage	V_{CES}		1200	V
Collector current (DC current)	I_C	$T_j = T_{jmax}$ $T_s \leq 80\text{ °C}$	70 ⁽¹⁾	A
Repetitive peak collector current	I_{CRM}	t_p limited by T_{jmax}	70	A
Total power dissipation	P_{tot}	$T_j = T_{jmax}$ $T_s = 80\text{ °C}$	129	W
Gate-emitter voltage	V_{GES}		± 20	V
Short circuit ratings	t_{SC}	$V_{GE} = 15\text{ V}$, $V_{CC} = 800\text{ V}$ $T_j = 150\text{ °C}$	9,5	μs
Maximum junction temperature	T_{jmax}		175	$^{\circ}\text{C}$

⁽¹⁾ limited by I_{CRM}

Inverter Diode

Peak repetitive reverse voltage	V_{RRM}		1200	V
Forward current (DC current)	I_F	$T_j = T_{jmax}$ $T_s = 80\text{ °C}$	45	A
Repetitive peak forward current	I_{FRM}	t_p limited by T_{jmax}	70	A
Total power dissipation	P_{tot}	$T_j = T_{jmax}$ $T_s = 80\text{ °C}$	89	W
Maximum junction temperature	T_{jmax}		175	$^{\circ}\text{C}$

Module Properties

Thermal Properties

Storage temperature	T_{stg}		-40...+125	$^{\circ}\text{C}$
Operation temperature under switching condition	T_{jop}		-40...+($T_{jmax} - 25$)	$^{\circ}\text{C}$

Isolation Properties

Isolation voltage	V_{isol}	DC Test Voltage* $t_p = 2\text{ s}$	5500	V
Creepage distance		With std lid For more informations see handling instructions	6,3	mm
Clearance		With std lid For more informations see handling instructions	6,3	mm
Comparative Tracking Index	CTI		≥ 600	

*100 % tested in production



Vincotech

Characteristic Values

Parameter	Symbol	Conditions					Values			Unit
		V_{GE} [V] V_{GS} [V]	V_{CE} [V] V_{DS} [V] V_F [V]	I_C [A] I_D [A] I_F [A]	T_j [°C]	Min	Typ	Max		

Inverter Switch

Static

Gate-emitter threshold voltage	$V_{GE(th)}$		10	0,0035	25	5,4	6	6,6	V
Collector-emitter saturation voltage	$V_{CE(sat)}$	15		35	25 125 150		1,47 1,64 1,68	1,85 ⁽²⁾	V
Collector-emitter cut-off current	I_{CES}	0	1200		25			80	μA
Gate-emitter leakage current	I_{GES}	20	0		25			200	nA
Internal gate resistance	r_g						None		Ω
Input capacitance	C_{ies}						7900		pF
Output capacitance	C_{oes}	0	10		25		270		pF
Reverse transfer capacitance	C_{res}						97		pF
Gate charge	Q_g	$V_{CC} = 600$ V	0/15		35	25	260		nC

Thermal

Thermal resistance junction to sink ⁽³⁾	$R_{th(j-s)}$	$\lambda_{paste} = 2,5$ W/mK (HPTP)					0,73		K/W
--	---------------	--	--	--	--	--	------	--	-----

Dynamic

Turn-on delay time	$t_{d(on)}$					25 125 150	124,2 122,4 121,4		ns
Rise time	t_r	$R_{gon} = 8$ Ω $R_{goff} = 8$ Ω				25 125 150	14,2 17 17,8		ns
Turn-off delay time	$t_{d(off)}$		±15	600	35	25 125 150	178,6 202,8 208,2		ns
Fall time	t_f					25 125 150	95,14 117,86 118,79		ns
Turn-on energy (per pulse)	E_{on}	$Q_{tFWD} = 4,34$ μC $Q_{tFWD} = 6,18$ μC $Q_{tFWD} = 6,9$ μC				25 125 150	1,45 1,92 2,09		mWs
Turn-off energy (per pulse)	E_{off}					25 125 150	2,4 3,17 3,42		mWs



Vincotech

80-M1126PA035M7-K210F70
datasheet

Characteristic Values

Parameter	Symbol	Conditions					Values			Unit
		V_{GE} [V] V_{GS} [V]	V_{CE} [V] V_{DS} [V] V_F [V]	I_C [A] I_D [A] I_F [A]	T_j [°C]	Min	Typ	Max		
Inverter Diode										
Static										
Forward voltage	V_F				35	25 125 150		1,66 1,76 1,75	2,1 ⁽²⁾	V
Reverse leakage current	I_R	$V_r = 1200$ V				25			40	μA
Thermal										
Thermal resistance junction to sink ⁽³⁾	$R_{th(j-s)}$	$\lambda_{paste} = 2,5$ W/mK (HPTP)						1,06		K/W
Dynamic										
Peak recovery current	I_{RM}	$di/dt=2681$ A/μs $di/dt=2670$ A/μs $di/dt=2690$ A/μs	±15	600	35	25 125 150		77,33 75,64 76,58		A
Reverse recovery time	t_{rr}					25 125 150		157,26 283,67 310,8		ns
Recovered charge	Q_r					25 125 150		4,34 6,18 6,9		μC
Reverse recovered energy	E_{rec}					25 125 150		1,96 2,82 3,13		mWs
Peak rate of fall of recovery current	$(di_r/dt)_{max}$					25 125 150		2734 2205 2101		A/μs



Vincotech

Characteristic Values

Parameter	Symbol	Conditions					Values			Unit
		V_{GS} [V]	V_{GE} [V]	V_{DS} [V]	V_{CE} [V]	I_D [A]	I_C [A]	T_j [°C]	Min	

Thermistor

Static

Rated resistance	R					25		1		kΩ
Deviation of R100	$A_{R/R}$	$R_{100} = 1670 \Omega$				100	-2		2	%
Maximum Current	I_{max}							3		mA
Power dissipation constant	d					25		0,76		mW/K
A-value	A							$7,635 \times 10^{-3}$		1/K
B-value	B							$1,73 \times 10^{-5}$		1/K ²
Vincotech Thermistor Reference									E	

⁽²⁾ Value at chip level

⁽³⁾ Only valid with pre-applied Vincotech thermal interface material.



Inverter Switch Characteristics

figure 1. IGBT

Typical output characteristics

$$I_C = f(V_{CE})$$

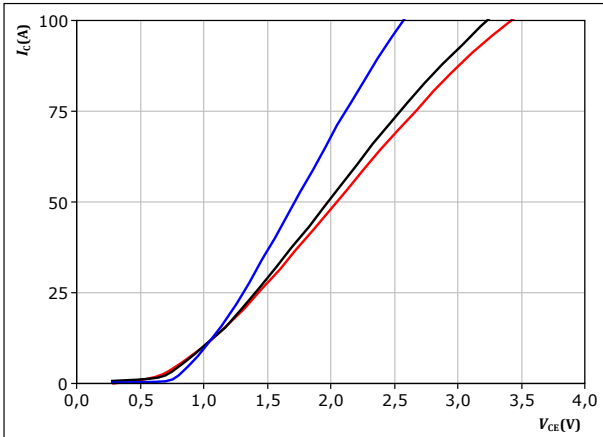

$t_p = 250 \mu s$
 $V_{GE} = 15 V$
 $T_j:$ — 25 °C
 — 125 °C
 — 150 °C

figure 2. IGBT

Typical output characteristics

$$I_C = f(V_{CE})$$

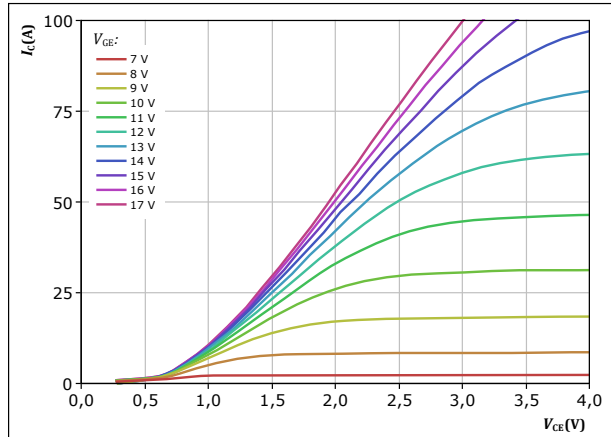

$t_p = 250 \mu s$
 $T_j = 150 \text{ }^\circ C$
 V_{GE} from 7 V to 17 V in steps of 1 V

figure 3. IGBT

Typical transfer characteristics

$$I_C = f(V_{GE})$$

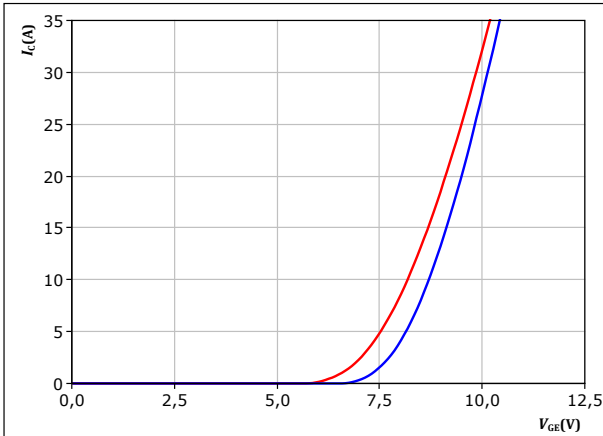

$t_p = 250 \mu s$
 $V_{CE} = 10 V$
 $T_j:$ — 25 °C
 — 125 °C

figure 4. IGBT

Transient thermal impedance as a function of pulse width

$$Z_{th(j-s)} = f(t_p)$$

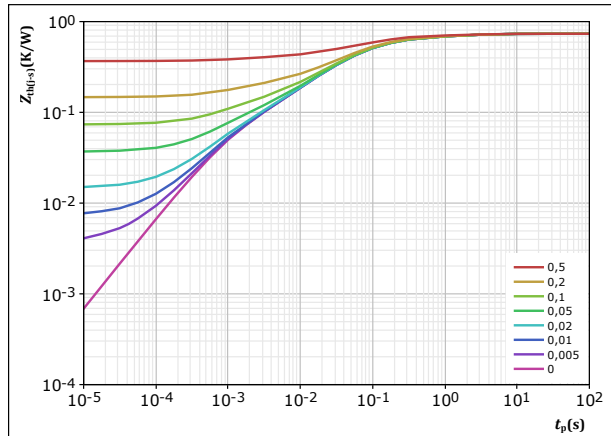

$D = t_p / T$
 $R_{th(j-s)} = 0,734 \text{ K/W}$
 IGBT thermal model values

R (K/W)	τ (s)
4,86E-02	2,88E+00
1,00E-01	4,81E-01
3,87E-01	7,10E-02
1,44E-01	1,25E-02
5,43E-02	1,05E-03



Inverter Switch Characteristics

figure 5. IGBT

Safe operating area
 $I_C = f(V_{CE})$

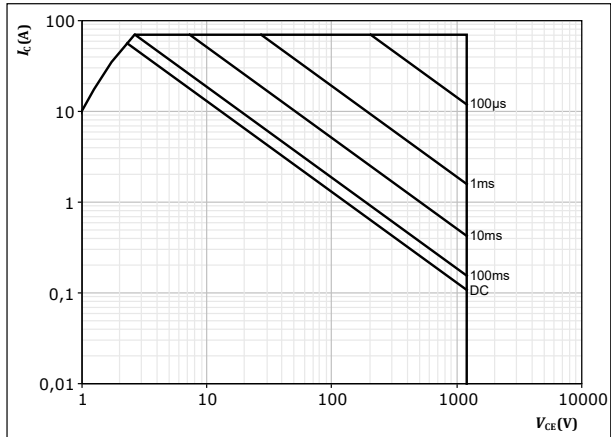

$D =$ single pulse
 $T_s = 80 \text{ } ^\circ\text{C}$
 $V_{GE} = 15 \text{ V}$
 $T_j = T_{jmax}$

figure 6. IGBT

Gate voltage vs gate charge
 $V_{GE} = f(Q_g)$

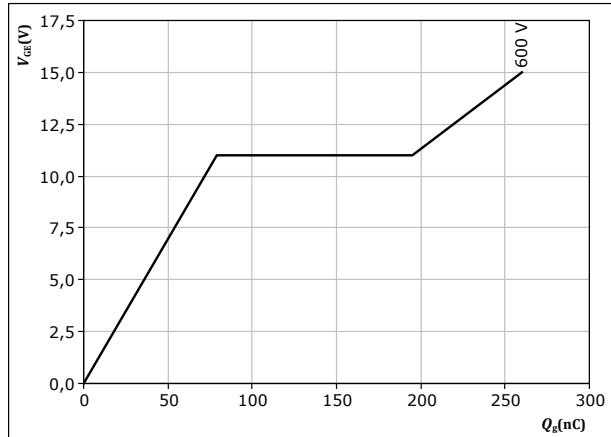

$I_C = 35 \text{ A}$
 $T_j = 25 \text{ } ^\circ\text{C}$



Inverter Diode Characteristics

figure 7. FWD

Typical forward characteristics

$$I_F = f(V_F)$$

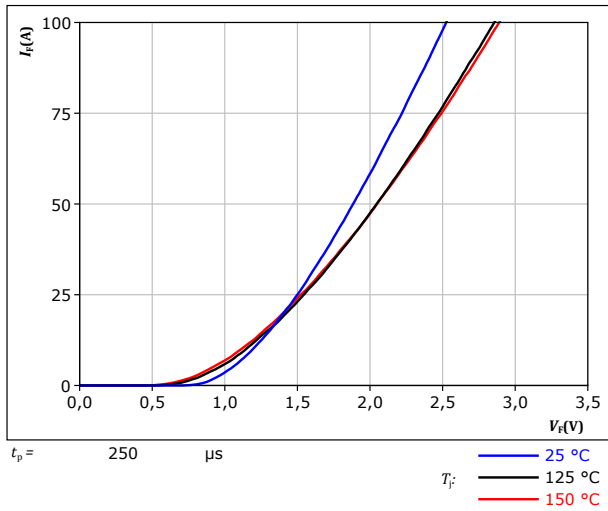
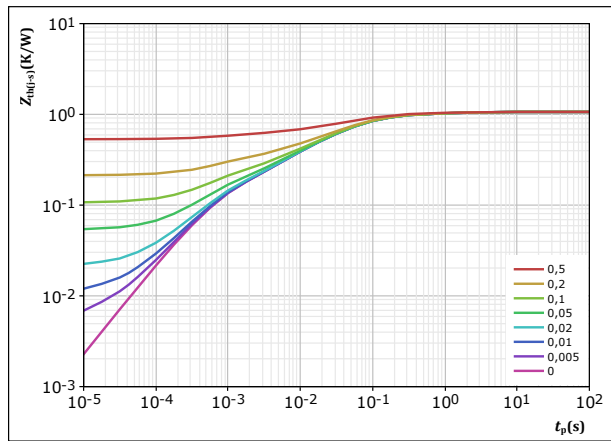

figure 8. FWD

Transient thermal impedance as a function of pulse width

$$Z_{th(j-s)} = f(t_p)$$



$D = \frac{t_p}{T}$
 $R_{th(j-s)} = 1,064 \text{ K/W}$
 FWD thermal model values

R (K/W)	τ (s)
6,06E-02	1,82E+00
2,37E-01	1,58E-01
4,33E-01	3,97E-02
2,08E-01	7,61E-03
1,26E-01	6,66E-04



Thermistor Characteristics

figure 9. Thermistor

Typical PTC characteristic as function of temperature

$$R_T = f(T)$$

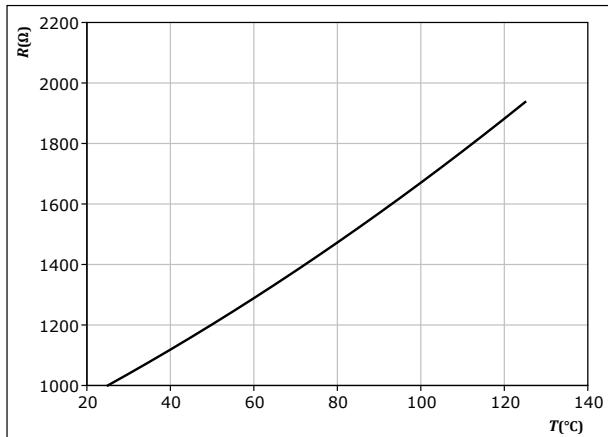



Inverter Switching Characteristics

figure 10. IGBT

Typical switching energy losses as a function of collector current
 $E = f(I_c)$

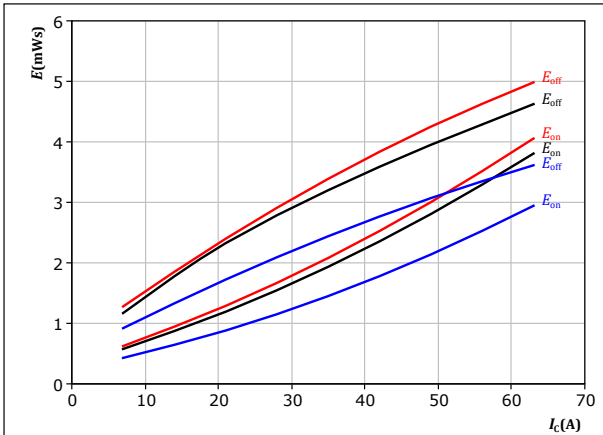

With an inductive load at

$V_{CE} = 600$ V	$T_j:$ 25 °C
$V_{GE} = \pm 15$ V	125 °C
$R_{gon} = 8$ Ω	150 °C
$R_{goff} = 8$ Ω	

figure 11. IGBT

Typical switching energy losses as a function of IGBT turn on gate resistor
 $E = f(R_g)$

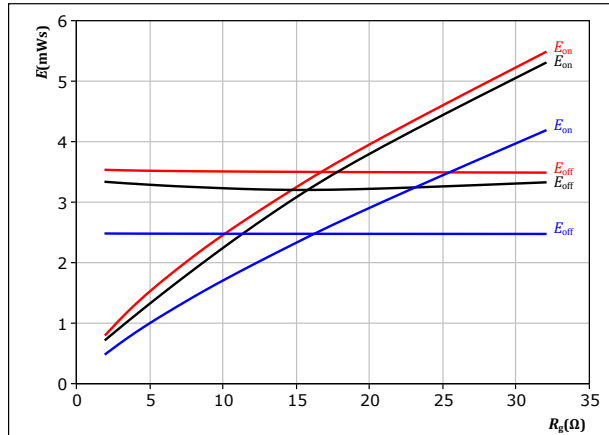

With an inductive load at

$V_{CE} = 600$ V	$T_j:$ 25 °C
$V_{GE} = \pm 15$ V	125 °C
$I_c = 35$ A	150 °C

figure 12. FWD

Typical reverse recovered energy loss as a function of collector current
 $E_{rec} = f(I_c)$

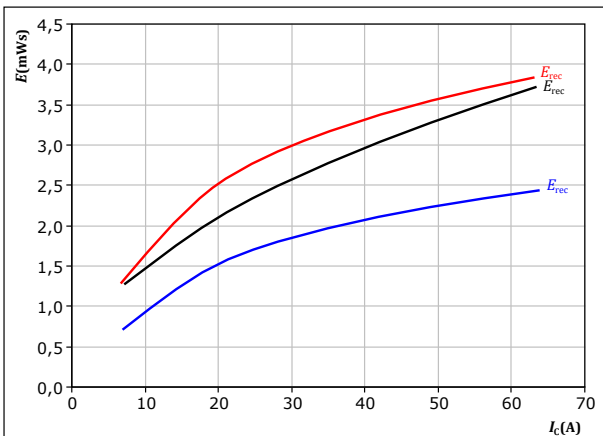

With an inductive load at

$V_{CE} = 600$ V	$T_j:$ 25 °C
$V_{GE} = \pm 15$ V	125 °C
$R_{gon} = 8$ Ω	150 °C

figure 13. FWD

Typical reverse recovered energy loss as a function of IGBT turn on gate resistor
 $E_{rec} = f(R_g)$

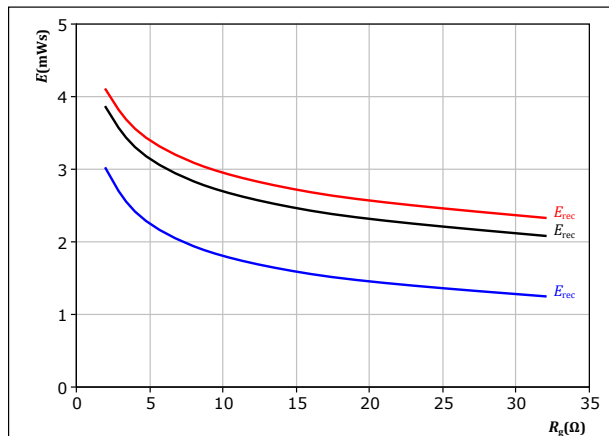

With an inductive load at

$V_{CE} = 600$ V	$T_j:$ 25 °C
$V_{GE} = \pm 15$ V	125 °C
$I_c = 35$ A	150 °C



Inverter Switching Characteristics

figure 14. IGBT

Typical switching times as a function of collector current
 $t = f(I_c)$

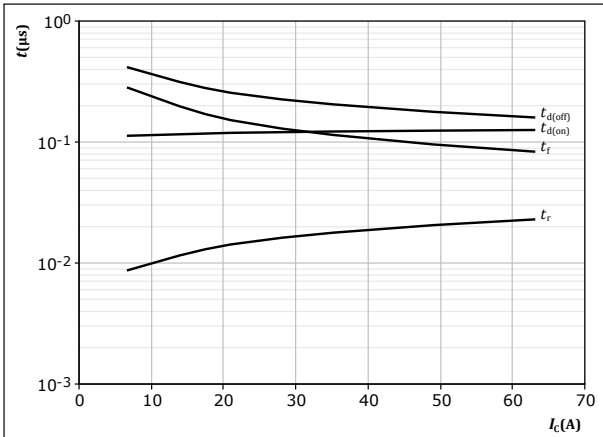

With an inductive load at
 $T_j = 150 \text{ }^\circ\text{C}$
 $V_{CE} = 600 \text{ V}$
 $V_{GE} = \pm 15 \text{ V}$
 $R_{gon} = 8 \text{ } \Omega$
 $R_{goff} = 8 \text{ } \Omega$

figure 15. IGBT

Typical switching times as a function of IGBT turn on gate resistor
 $t = f(R_g)$

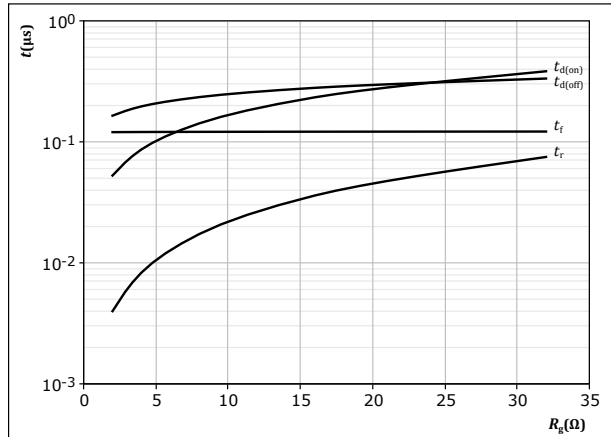

With an inductive load at
 $T_j = 150 \text{ }^\circ\text{C}$
 $V_{CE} = 600 \text{ V}$
 $V_{GE} = \pm 15 \text{ V}$
 $I_c = 35 \text{ A}$

figure 16. FWD

Typical reverse recovery time as a function of collector current
 $t_{rr} = f(I_c)$

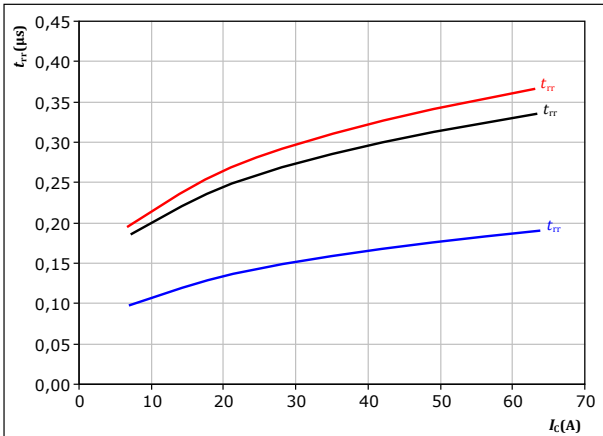

With an inductive load at
 $V_{CE} = 600 \text{ V}$
 $V_{GE} = \pm 15 \text{ V}$
 $R_{gon} = 8 \text{ } \Omega$
 $T_j:$ — 25 °C
— 125 °C
— 150 °C

figure 17. FWD

Typical reverse recovery time as a function of IGBT turn on gate resistor
 $t_{rr} = f(R_{gon})$

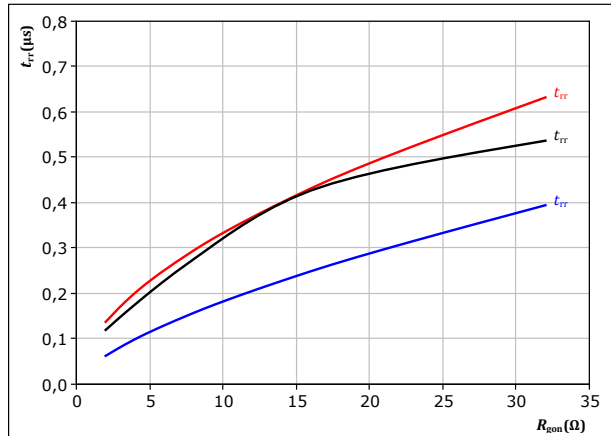

With an inductive load at
 $V_{CE} = 600 \text{ V}$
 $V_{GE} = \pm 15 \text{ V}$
 $I_c = 35 \text{ A}$
 $T_j:$ — 25 °C
— 125 °C
— 150 °C



Inverter Switching Characteristics

figure 18. FWD

Typical recovered charge as a function of collector current

$$Q_r = f(I_c)$$

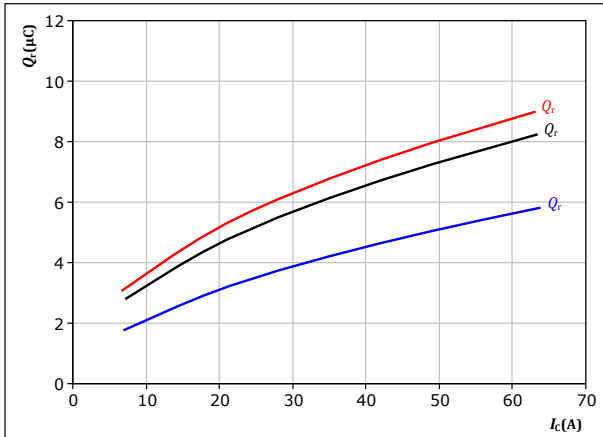

With an inductive load at

$V_{CE} = 600 \text{ V}$
 $V_{GE} = \pm 15 \text{ V}$
 $R_{gon} = 8 \ \Omega$

T_j : — 25 °C
 — 125 °C
 — 150 °C

figure 19. FWD

Typical recovered charge as a function of IGBT turn on gate resistor

$$Q_r = f(R_{gon})$$

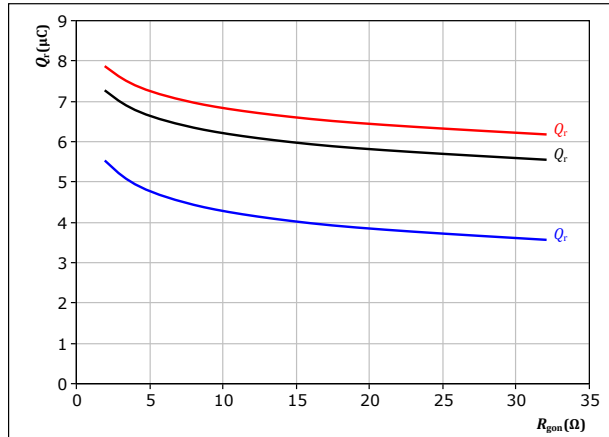

With an inductive load at

$V_{CE} = 600 \text{ V}$
 $V_{GE} = \pm 15 \text{ V}$
 $I_c = 35 \text{ A}$

T_j : — 25 °C
 — 125 °C
 — 150 °C

figure 20. FWD

Typical peak reverse recovery current as a function of collector current

$$I_{RM} = f(I_c)$$

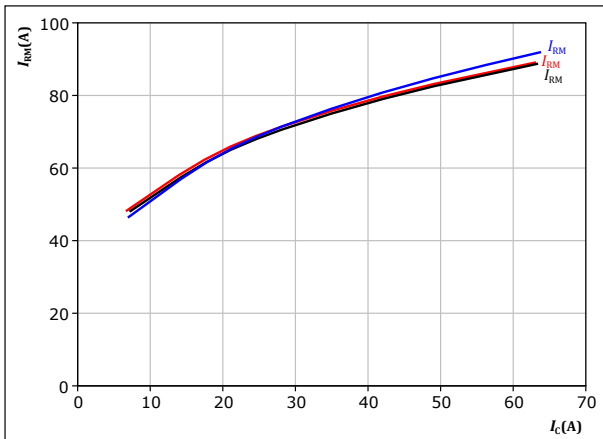

With an inductive load at

$V_{CE} = 600 \text{ V}$
 $V_{GE} = \pm 15 \text{ V}$
 $R_{gon} = 8 \ \Omega$

T_j : — 25 °C
 — 125 °C
 — 150 °C

figure 21. FWD

Typical peak reverse recovery current as a function of IGBT turn on gate resistor

$$I_{RM} = f(R_{gon})$$

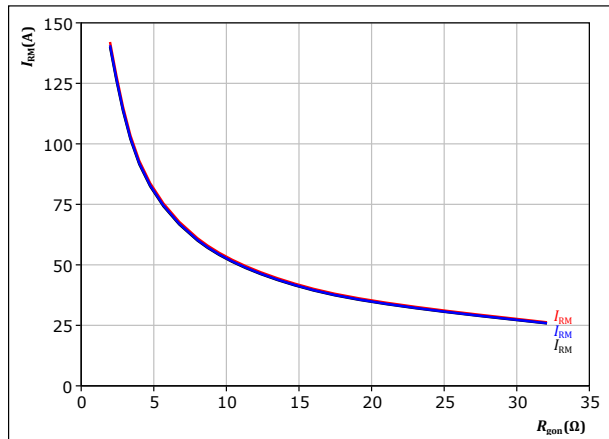

With an inductive load at

$V_{CE} = 600 \text{ V}$
 $V_{GE} = \pm 15 \text{ V}$
 $I_c = 35 \text{ A}$

T_j : — 25 °C
 — 125 °C
 — 150 °C



Inverter Switching Characteristics

figure 22. FWD

Typical rate of fall of forward and reverse recovery current as a function of collector current
 $di_f/dt, di_r/dt = f(I_C)$

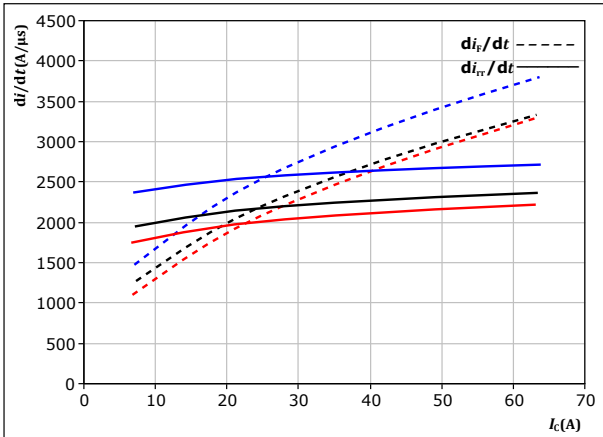

With an inductive load at

$V_{CE} = 600 \text{ V}$
 $V_{GE} = \pm 15 \text{ V}$
 $R_{gon} = 8 \ \Omega$

$T_j:$ — 25 °C
 — 125 °C
 — 150 °C

figure 23. FWD

Typical rate of fall of forward and reverse recovery current as a function of turn on gate resistor
 $di_f/dt, di_r/dt = f(R_{gon})$

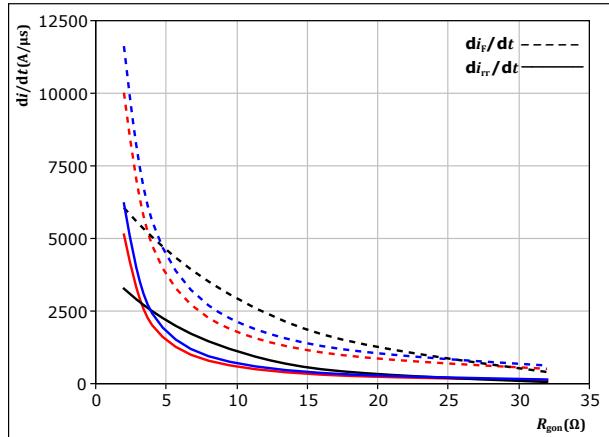

With an inductive load at

$V_{CE} = 600 \text{ V}$
 $V_{GE} = \pm 15 \text{ V}$
 $I_C = 35 \text{ A}$

$T_j:$ — 25 °C
 — 125 °C
 — 150 °C

figure 24. IGBT

Reverse bias safe operating area

$I_C = f(V_{CE})$

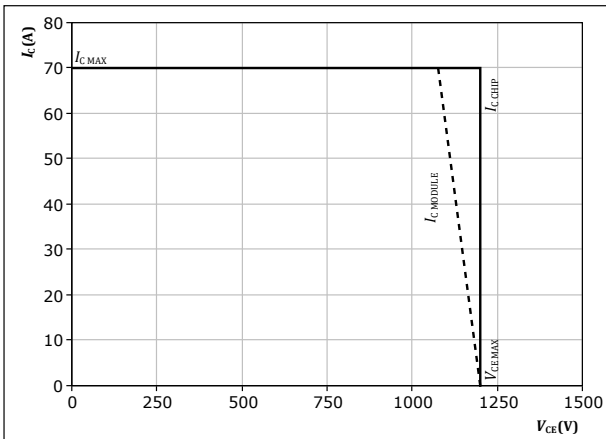

At $T_j = 150 \text{ °C}$
 $R_{gon} = 8 \ \Omega$
 $R_{goff} = 8 \ \Omega$



Inverter Switching Definitions

figure 25. IGBT
Turn-off Switching Waveforms & definition of t_{doff} , t_{Eoff} (t_{Eoff} = integrating time for E_{off})

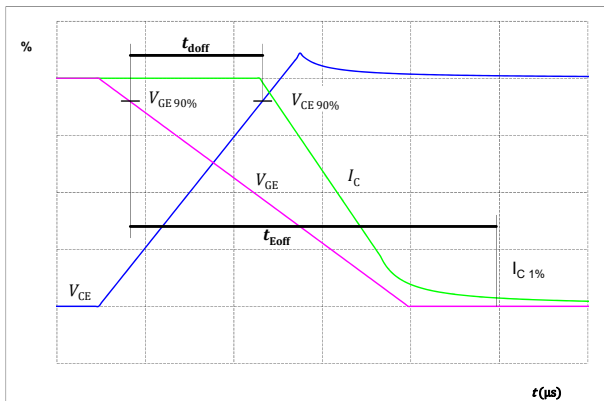

figure 26. IGBT
Turn-on Switching Waveforms & definition of t_{don} , t_{Eon} (t_{Eon} = integrating time for E_{on})



figure 27. IGBT
Turn-off Switching Waveforms & definition of t_f

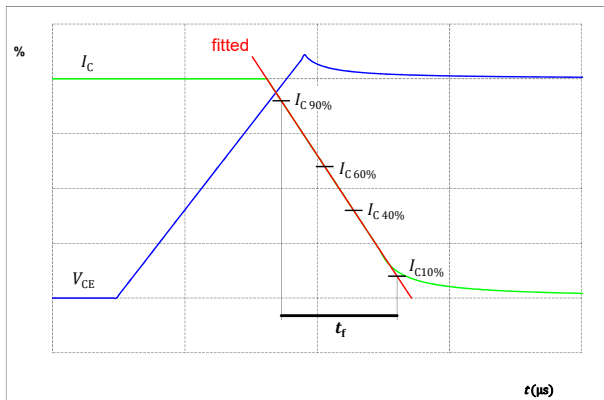
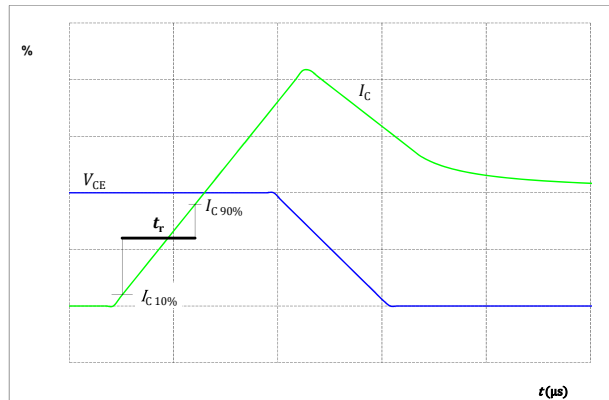

figure 28. IGBT
Turn-on Switching Waveforms & definition of t_r





Inverter Switching Definitions

figure 29. FWD

Turn-off Switching Waveforms & definition of t_{rr}



figure 30. FWD

Turn-on Switching Waveforms & definition of t_{Qr} (t_{Qr} = integrating time for Q_r)

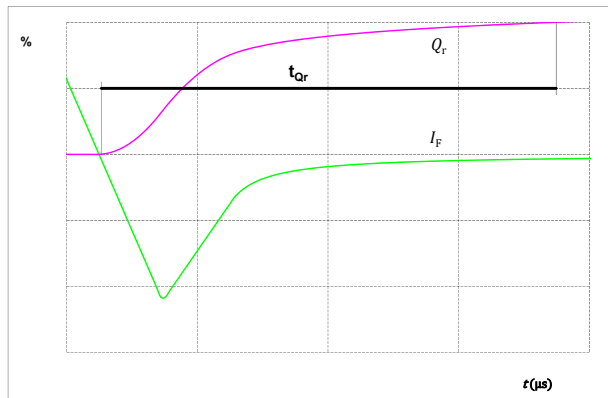



Vincotech

Ordering Code	
Version	Ordering Code
With std lid (6.5mm height) + no thermal grease	80-M1126PA035M7-K210F70-/0A/
With thin lid (2.8mm height) + no thermal grease	80-M1126PA035M7-K210F70-/0B/
With std lid (6.5mm height) + thermal grease (0,8 W/mK, P12, silicone-based)	80-M1126PA035M7-K210F70-/1A/
With thin lid (2.8mm height) + thermal grease (0,8 W/mK, P12, silicone-based)	80-M1126PA035M7-K210F70-/1B/
With std lid (6.5mm height) + thermal grease (2,5 W/mK, TG20032, silicone-free)	80-M1126PA035M7-K210F70-/4A/
With thin lid (2.8mm height) + thermal grease (2,5 W/mK, TG20032, silicone-free)	80-M1126PA035M7-K210F70-/4B/
With std lid (6.5mm height) + thermal grease (2,5 W/mK, HPTP, silicone-based)	80-M1126PA035M7-K210F70-/5A/
With thin lid (2.8mm height) + thermal grease (2,5 W/mK, HPTP, silicone-based)	80-M1126PA035M7-K210F70-/5B/

Marking						
Text	Name		Date code	UL & VIN	Lot	Serial
		NN-NNNNNNNNNNNNNN- TTTTTTTV		WWYY	UL VIN	LLLLL
Datamatrix		Type&Ver	Lot number	Serial	Date code	
	TTTTTTTV	LLLLL	SSSS	WWYY		

Outline				
Pin table [mm]				
Pin	X	Y	Function	
1	15,93	-14,6	G16	
2	15,93	-9,8	Ph3	
3	15,93	-5	Ph3	
4	not assembled			
5	15,93	7,62	G15	
6	15,93	12,62	Therm1	
7	15,93	15,8	Therm2	
8	not assembled			
9	8,23	12,62	DC-3	
10	8,23	15,8	DC-3	
11	7,73	-14,6	G14	
12	not assembled			
13	not assembled			
14	0,53	9,45	G13	
15	0,53	12,62	DC-2	
16	0,53	15,8	DC-2	
17	-0,47	-14,6	Ph2	
18	-0,47	-9,8	Ph2	
19	not assembled			
20	not assembled			
21	-7,17	12,62	DC-1	
22	-7,17	15,8	DC-1	
23	-8,07	-14,6	DC+	
24	-8,07	-9,8	DC+	
25	-15,02	-15,8	G12	
26	-15,02	-9,8	Ph1	
27	-15,02	0	Ph1	
28	not assembled			
29	-15,02	15,8	G11	

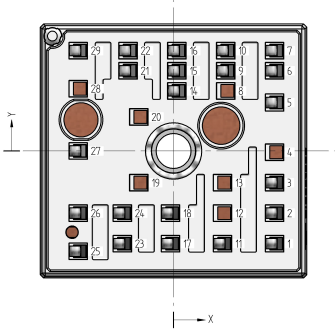

Pad positions refers to center point. For more informations on pad design please see package data



Vincotech

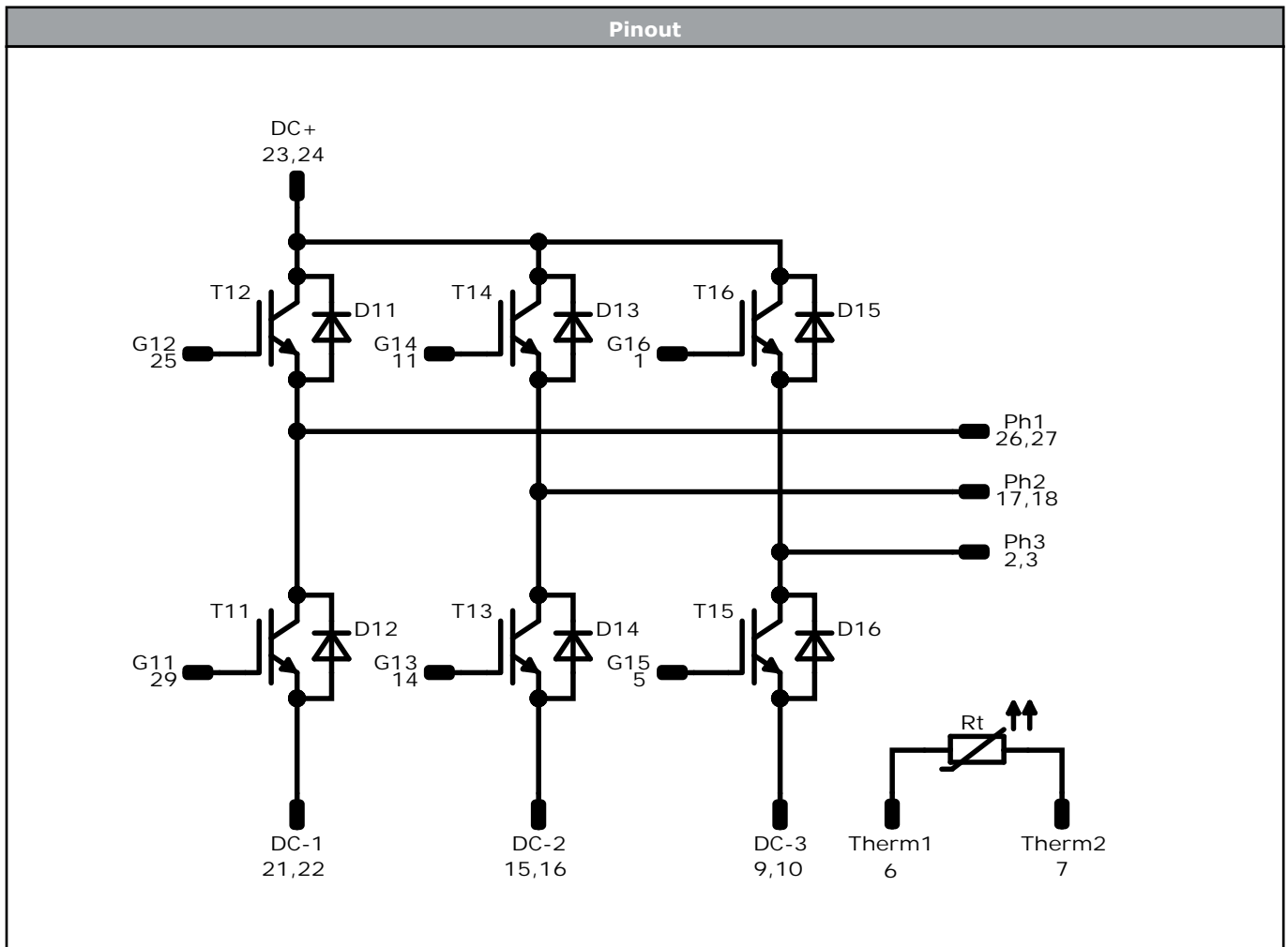

Identification					
ID	Component	Voltage	Current	Function	Comment
T11, T12, T13, T14, T15, T16	IGBT	1200 V	35 A	Inverter Switch	
D11, D12, D13, D14, D15, D16	FWD	1200 V	35 A	Inverter Diode	
Rt	Thermistor			Thermistor	



Packaging instruction				
Standard packaging quantity (SPQ) 120	>SPQ	Standard	<SPQ	Sample

Handling instruction
Handling instructions for MiniSKiiP® 1 packages see vincotech.com website.

Package data
Package data for MiniSKiiP® 1 packages see vincotech.com website.

Vincotech thermistor reference
See Vincotech thermistor reference table at vincotech.com website.

UL recognition and file number
This device is UL 1557 recognized under E192116 up to a junction temperature under switching condition $T_{j,sw}=150^{\circ}\text{C}$ and up to 2500VAC/1min isolation voltage. For more information see vincotech.com website.



Document No.:	Date:	Modification:	Pages
80-M1126PA035M7-K210F70-D2-14	26 Mar. 2024	Correction of Maximum Ratings values New datasheet format, module is unchanged	

DISCLAIMER

The information, specifications, procedures, methods and recommendations herein (together "information") are presented by Vincotech to reader in good faith, are believed to be accurate and reliable, but may well be incomplete and/or not applicable to all conditions or situations that may exist or occur. Vincotech reserves the right to make any changes without further notice to any products to improve reliability, function or design. No representation, guarantee or warranty is made to reader as to the accuracy, reliability or completeness of said information or that the application or use of any of the same will avoid hazards, accidents, losses, damages or injury of any kind to persons or property or that the same will not infringe third parties rights or give desired results. It is reader's sole responsibility to test and determine the suitability of the information and the product for reader's intended use.

LIFE SUPPORT POLICY

Vincotech products are not authorised for use as critical components in life support devices or systems without the express written approval of Vincotech.

As used herein:

1. Life support devices or systems are devices or systems which, (a) are intended for surgical implant into the body, or (b) support or sustain life, or (c) whose failure to perform when properly used in accordance with instructions for use provided in labelling can be reasonably expected to result in significant injury to the user.
2. A critical component is any component of a life support device or system whose failure to perform can be reasonably expected to cause the failure of the life support device or system, or to affect its safety or effectiveness.