



flowNPC E3BP

1200 V / 560 A

Topology features

- Low side Kelvin Emitter for improved switching performance
- Neutral Point Clamped Topology (I-Type)
- Split topology
- Temperature sensor

Component features

- High speed switching
- Low collector emitter saturation voltage
- Low turn-off losses
- Optimized for hard switching topologies
- Positive temperature coefficient

Housing features

- Base isolation: Al₂O₃
- Cu baseplate
- Convex shaped baseplate for superior thermal contact
- CTI600 housing material
- Baseplate with rough surface
- Thermo-mechanical push-and-pull force relief
- Solder pin

Target applications

- Energy Storage Systems
- Solar Inverters

Types

- 30-E312NIC560H7-PU10F57Z

flow E3BP 12 mm housing

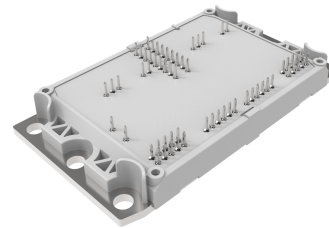

Schematic

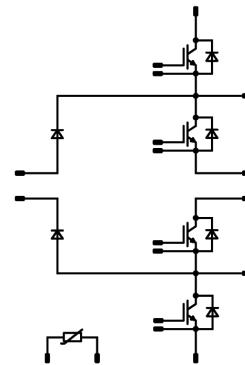



Vincotech

30-E312NIC560H7-PU10F57Z
datasheet

Maximum Ratings

$T_j = 25\text{ °C}$, unless otherwise specified

Parameter	Symbol	Conditions	Value	Unit
Buck Switch				
Collector-emitter voltage	V_{CES}		1200	V
Collector current (DC current)	I_C	$T_j = T_{jmax}$ $T_s = 80\text{ °C}$	290	A
Repetitive peak collector current	I_{CRM}	t_p limited by T_{jmax}	1680	A
Turn off safe operating area		$T_j = 150\text{ °C}$, $V_{CE} = 1200\text{ V}$	1680	A
Total power dissipation	P_{tot}	$T_j = T_{jmax}$ $T_s = 80\text{ °C}$	495	W
Gate-emitter voltage	V_{GES}		± 20	V
Maximum junction temperature	T_{jmax}		175	°C

Buck Diode

Peak repetitive reverse voltage	V_{RRM}		1200	V
Forward current (DC current)	I_F	$T_j = T_{jmax}$ $T_s = 80\text{ °C}$	176	A
Repetitive peak forward current	I_{FRM}	t_p limited by T_{jmax}	480	A
Surge (non-repetitive) forward current	I_{FSM}	Single Half Sine Wave, $t_p = 10\text{ ms}$ $T_j = 25\text{ °C}$	1920	A
Total power dissipation	P_{tot}	$T_j = T_{jmax}$ $T_s = 80\text{ °C}$	316	W
Maximum junction temperature	T_{jmax}		175	°C

Boost Switch

Collector-emitter voltage	V_{CES}		1200	V
Collector current (DC current)	I_C	$T_j = T_{jmax}$ $T_s = 80\text{ °C}$	290	A
Repetitive peak collector current	I_{CRM}	t_p limited by T_{jmax}	1680	A
Turn off safe operating area		$T_j = 150\text{ °C}$, $V_{CE} = 1200\text{ V}$	1680	A
Total power dissipation	P_{tot}	$T_j = T_{jmax}$ $T_s = 80\text{ °C}$	495	W
Gate-emitter voltage	V_{GES}		± 20	V
Maximum junction temperature	T_{jmax}		175	°C



Vincotech

Maximum Ratings

$T_j = 25\text{ °C}$, unless otherwise specified

Parameter	Symbol	Conditions	Value	Unit
Boost Diode				
Peak repetitive reverse voltage	V_{RRM}		1200	V
Forward current (DC current)	I_F	$T_j = T_{jmax}$ $T_s = 80\text{ °C}$	176	A
Repetitive peak forward current	I_{FRM}	t_p limited by T_{jmax}	480	A
Surge (non-repetitive) forward current	I_{FSM}	Single Half Sine Wave, $t_p = 10\text{ ms}$ $T_j = 25\text{ °C}$	1920	A
Total power dissipation	P_{tot}	$T_j = T_{jmax}$ $T_s = 80\text{ °C}$	316	W
Maximum junction temperature	T_{jmax}		175	°C

Boost Sw. Inv. Diode

Peak repetitive reverse voltage	V_{RRM}		1200	V
Forward current (DC current)	I_F	$T_j = T_{jmax}$ $T_s = 80\text{ °C}$	187	A
Repetitive peak forward current	I_{FRM}	t_p limited by T_{jmax}	600	A
Total power dissipation	P_{tot}	$T_j = T_{jmax}$ $T_s = 80\text{ °C}$	287	W
Maximum junction temperature	T_{jmax}		175	°C

Module Properties

Thermal Properties

Storage temperature	T_{stg}		-40...+125	°C
Operation temperature under switching condition	T_{jop}		-40...+($T_{jmax} - 25$)	°C

Isolation Properties

Isolation voltage	V_{isol}	DC Test Voltage* $t_p = 2\text{ s}$	6800	V
Creepage distance			>12,7	mm
Clearance			11,76	mm
Comparative Tracking Index	CTI		≥ 200	

*100 % tested in production



Vincotech

30-E312NIC560H7-PU10F57Z
datasheet

Characteristic Values

Parameter	Symbol	Conditions					Values			Unit
		V_{GS} [V]	V_{GE} [V]	V_{DS} [V]	I_D [A]	T_j [°C]	Min	Typ	Max	

Buck Switch

Static

Gate-emitter threshold voltage	$V_{GE(th)}$	$V_{CE} = V_{GE}$			0,0048	25	4,7	5,5	6,2	V
Collector-emitter saturation voltage	$V_{CE(sat)}$		15		560	25 125 150		1,79 2,03 2,08	2,15 ⁽¹⁾	V
Collector-emitter cut-off current	I_{CES}		0	1200		25			16	μA
Gate-emitter leakage current	I_{GES}		20	0		25			400	nA
Internal gate resistance	r_g							None		Ω
Input capacitance	C_{ies}							74000		pF
Output capacitance	C_{oes}	$f = 100$ kHz	0	25		25		1268		pF
Reverse transfer capacitance	C_{res}							376		pF
Gate charge	Q_g	$V_{CC} = 960$ V	0/15		560	25		4128		nC

Thermal

Thermal resistance junction to sink ⁽²⁾	$R_{th(j-s)}$	$\lambda_{paste} = 5,2$ W/mK (PTM)						0,19		K/W
--	---------------	---------------------------------------	--	--	--	--	--	------	--	-----

Dynamic

Turn-on delay time	$t_{d(on)}$					25 125 150		907,3 891,46 887,56		ns
Rise time	t_r					25 125 150		75,17 76,89 76,95		ns
Turn-off delay time	$t_{d(off)}$					25 125 150		2337,34 2440,9 2466,79		ns
Fall time	t_f					25 125 150		37,38 26,38 33,59		ns
Turn-on energy (per pulse)	E_{on}	$Q_{tFWD} = 0,919$ μC $Q_{tFWD} = 0,993$ μC $Q_{tFWD} = 1,02$ μC				25 125 150		19,02 17,52 17,94		mWs
Turn-off energy (per pulse)	E_{off}					25 125 150		23,32 25,05 28,63		mWs



Vincotech

30-E312NIC560H7-PU10F57Z
datasheet

Characteristic Values

Parameter	Symbol	Conditions					Values			Unit
		V_{GE} [V] V_{GS} [V]	V_{CE} [V] V_{DS} [V] V_F [V]	I_C [A] I_D [A] I_F [A]	T_j [°C]	Min	Typ	Max		
Buck Diode										
Static										
Forward voltage	V_F				240	25 125 150		1,53 1,89 2,03	1,65 ⁽¹⁾ 2,3 ⁽¹⁾	V
Reverse leakage current	I_R	$V_r = 1200$ V				25		12	1200	μA
Thermal										
Thermal resistance junction to sink ⁽²⁾	$R_{th(j-s)}$	$\lambda_{paste} = 5,2$ W/mK (PTM)						0,3		K/W
Dynamic										
Peak recovery current	I_{RM}					25 125 150		57,06 60,3 61,57		A
Reverse recovery time	t_{rr}					25 125 150		26,41 27,4 27,17		ns
Recovered charge	Q_r	$di/dt=4135$ A/μs $di/dt=7502$ A/μs $di/dt=4154$ A/μs	-10/15	600	400	25 125 150		0,919 0,993 1,02		μC
Reverse recovered energy	E_{rec}					25 125 150		0,19 0,215 0,221		mWs
Peak rate of fall of recovery current	$(di_r/dt)_{max}$					25 125 150		5160,49 6170,23 6082,26		A/μs



Vincotech

30-E312NIC560H7-PU10F57Z
datasheet

Characteristic Values

Parameter	Symbol	Conditions					Values			Unit
		V_{GS} [V]	V_{GE} [V]	V_{DS} [V]	I_D [A]	T_j [°C]	Min	Typ	Max	

Boost Switch

Static

Gate-emitter threshold voltage	$V_{GE(th)}$	$V_{CE} = V_{GE}$			0,0048	25	4,7	5,5	6,2	V
Collector-emitter saturation voltage	$V_{CE(sat)}$		15		560	25 125 150		1,79 2,03 2,08	2,15 ⁽¹⁾	V
Collector-emitter cut-off current	I_{CES}		0	1200		25			16	μA
Gate-emitter leakage current	I_{GES}		20	0		25			400	nA
Internal gate resistance	r_g							None		Ω
Input capacitance	C_{ies}							74000		pF
Output capacitance	C_{oes}	$f = 100$ kHz	0	25		25		1268		pF
Reverse transfer capacitance	C_{res}							376		pF
Gate charge	Q_g	$V_{CC} = 960$ V	0/15		560	25		4128		nC

Thermal

Thermal resistance junction to sink ⁽²⁾	$R_{th(j-s)}$	$\lambda_{paste} = 5,2$ W/mK (PTM)						0,19		K/W
--	---------------	---------------------------------------	--	--	--	--	--	------	--	-----

Dynamic

Turn-on delay time	$t_{d(on)}$					25 125 150		920,36 908,42 902,82		ns
Rise time	t_r	$R_{gon} = 5,95$ Ω $R_{goff} = 12,19$ Ω				25 125 150		81,15 80,4 81,71		ns
Turn-off delay time	$t_{d(off)}$		-10/15	600	400	25 125 150		2215,66 2310,5 2337,69		ns
Fall time	t_f					25 125 150		33,45 23,4 29,35		ns
Turn-on energy (per pulse)	E_{on}	$Q_{tFWD} = 0,71$ μC $Q_{tFWD} = 0,768$ μC $Q_{tFWD} = 0,836$ μC				25 125 150		20,26 19,56 19,47		mWs
Turn-off energy (per pulse)	E_{off}					25 125 150		19,05 23 24,96		mWs



Vincotech

Characteristic Values

Parameter	Symbol	Conditions					Values			Unit
		V_{GE} [V] V_{GS} [V]	V_{CE} [V] V_{DS} [V] V_F [V]	I_C [A] I_D [A] I_F [A]	T_j [°C]	Min	Typ	Max		
Boost Diode										
Static										
Forward voltage	V_F				240	25 125 150		1,53 1,89 2,03	1,65 ⁽¹⁾ 2,3 ⁽¹⁾	V
Reverse leakage current	I_R	$V_r = 1200$ V				25		12	1200	μA
Thermal										
Thermal resistance junction to sink ⁽²⁾	$R_{th(j-s)}$	$\lambda_{paste} = 5,2$ W/mK (PTM)						0,3		K/W
Dynamic										
Peak recovery current	I_{RM}					25 125 150		46,17 50,44 52,41		A
Reverse recovery time	t_{rr}					25 125 150		25,13 25,53 27,44		ns
Recovered charge	Q_r	$di/dt=5976$ A/μs $di/dt=3750$ A/μs $di/dt=5984$ A/μs	-10/15	600	400	25 125 150		0,71 0,768 0,836		μC
Reverse recovered energy	E_{rec}					25 125 150		0,125 0,139 0,154		mWs
Peak rate of fall of recovery current	$(di_r/dt)_{max}$					25 125 150		4780,52 4769,88 5311,72		A/μs



Vincotech

Characteristic Values

Parameter	Symbol	Conditions					Values			Unit
		V_{GE} [V] V_{GS} [V]	V_{CE} [V] V_{DS} [V] V_F [V]	I_C [A] I_D [A] I_F [A]	T_j [°C]	Min	Typ	Max		

Boost Sw. Inv. Diode

Static

Forward voltage	V_F				300	25 125 150	1,45	1,91 1,93 1,91	1,95 ⁽¹⁾	V
Reverse leakage current	I_R	$V_r = 1200$ V				25			3	μA

Thermal

Thermal resistance junction to sink ⁽²⁾	$R_{th(j-s)}$	$\lambda_{paste} = 5,2$ W/mK (PTM)						0,33		K/W
--	---------------	---------------------------------------	--	--	--	--	--	------	--	-----

Thermistor

Static

Rated resistance	R					25		22		kΩ
Deviation of R100	$\Delta_{R/R}$	$R_{100} = 1484$ Ω				100	-5		5	%
Power dissipation	P					25		130		mW
Power dissipation constant	d					25		1,5		mW/K
B-value	$B_{(25/50)}$	Tol. ±1 %						3962		K
B-value	$B_{(25/100)}$	Tol. ±1 %						4000		K
Vincotech Thermistor Reference									I	

⁽¹⁾ Value at chip level

⁽²⁾ Only valid with pre-applied Vincotech thermal interface material.



Buck Switch Characteristics

figure 1. IGBT

Typical output characteristics

$$I_C = f(V_{CE})$$

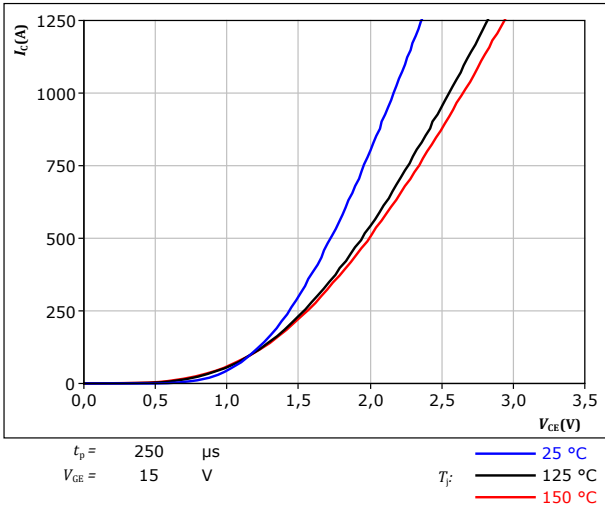

figure 2. IGBT

Typical output characteristics

$$I_C = f(V_{CE})$$

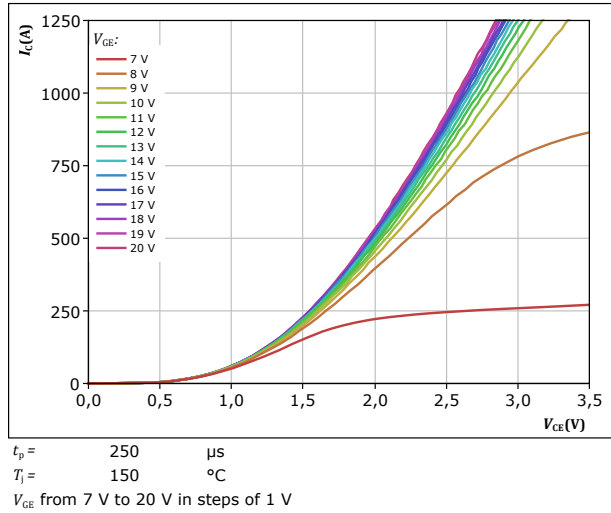

figure 3. IGBT

Typical transfer characteristics

$$I_C = f(V_{GE})$$

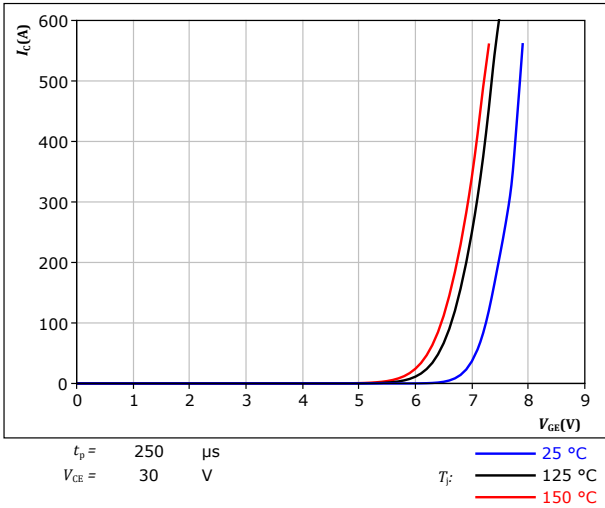
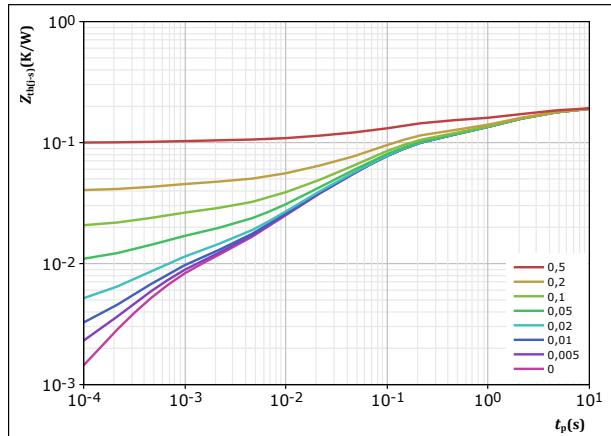

figure 4. IGBT

Transient thermal impedance as a function of pulse width

$$Z_{th(j-s)} = f(t_p)$$



$D = t_p / T$
 $R_{th(j-s)} = 0,192 \text{ K/W}$

IGBT thermal model values

R (K/W)	τ (s)
3,88E-02	6,87E+00
6,56E-02	1,33E+00
7,12E-02	8,85E-02
1,67E-02	1,12E-02
7,15E-03	5,40E-04



Buck Switch Characteristics

figure 5. IGBT

Safe operating area
 $I_C = f(V_{CE})$

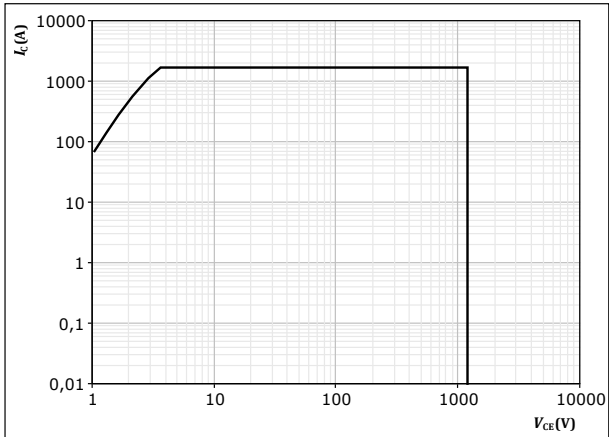

$D =$ single pulse
 $T_s = 80$ °C
 $V_{GE} = 15$ V
 $T_j = T_{jmax}$

figure 6. IGBT

Gate voltage vs gate charge
 $V_{GE} = f(Q_g)$

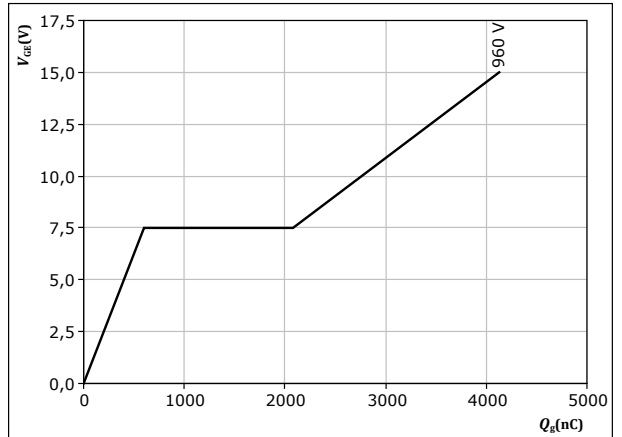

$I_C = 560$ A
 $T_j = 25$ °C



Buck Diode Characteristics

figure 7. FWD

Typical forward characteristics

$$I_F = f(V_F)$$

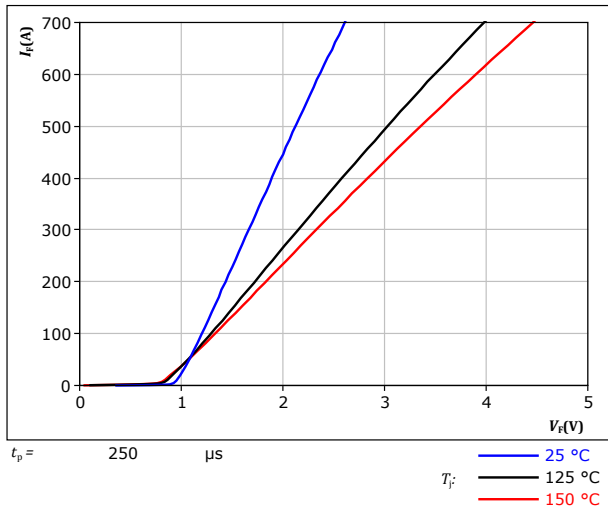
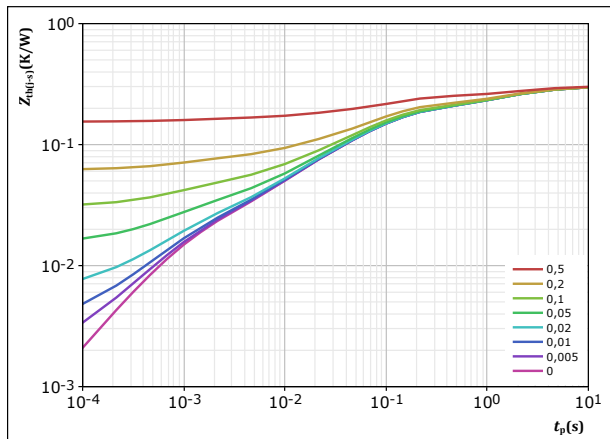

figure 8. FWD

Transient thermal impedance as a function of pulse width

$$Z_{th(j-s)} = f(t_p)$$



$D =$	t_p / T	
$R_{th(j-s)} =$	0,3	K/W
FWD thermal model values		
R (K/W)	τ (s)	
3,83E-02	8,10E+00	
8,96E-02	1,32E+00	
1,33E-01	8,16E-02	
3,22E-02	1,19E-02	
1,60E-02	9,15E-04	



Boost Switch Characteristics

figure 9. IGBT

Typical output characteristics

$$I_C = f(V_{CE})$$

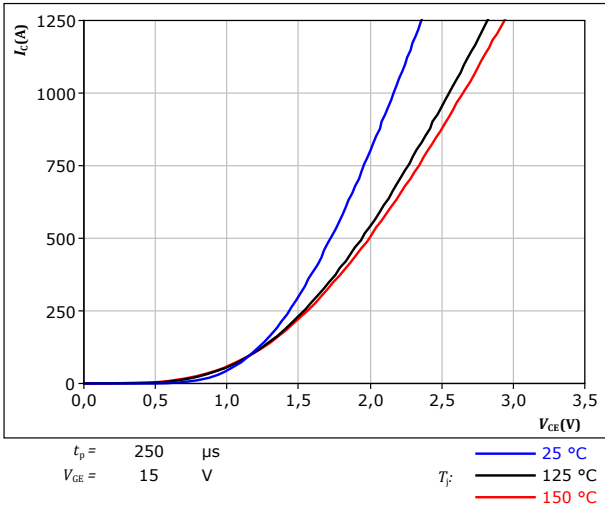

figure 10. IGBT

Typical output characteristics

$$I_C = f(V_{CE})$$

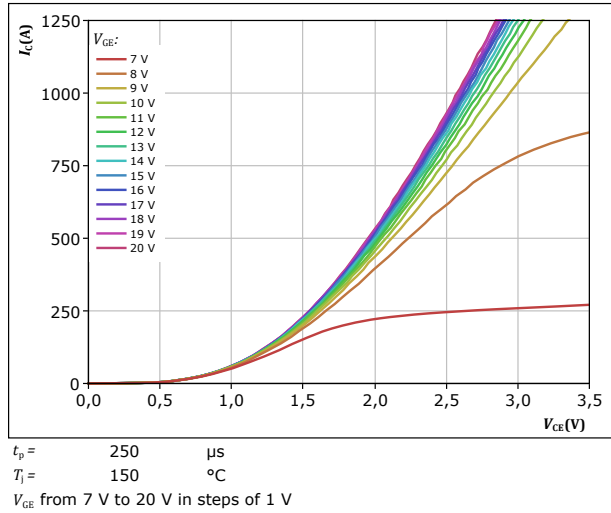

figure 11. IGBT

Typical transfer characteristics

$$I_C = f(V_{GE})$$

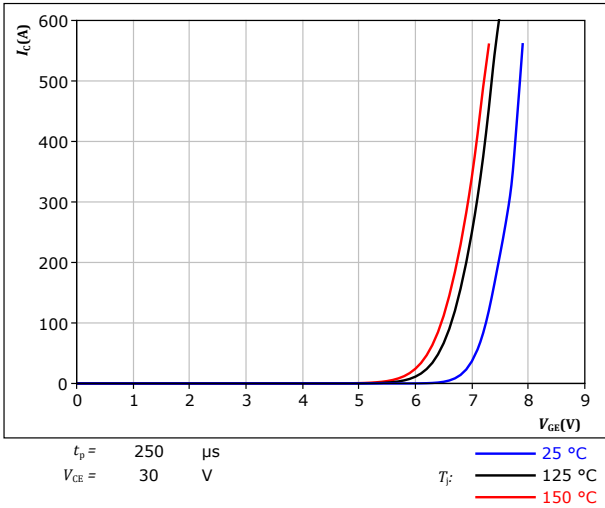
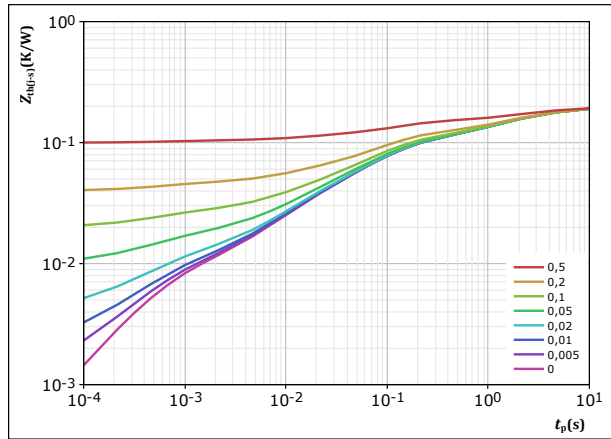

figure 12. IGBT

Transient thermal impedance as a function of pulse width

$$Z_{th(j-s)} = f(t_p)$$



$D = t_p / T$
 $R_{th(j-s)} = 0,192 \text{ K/W}$

IGBT thermal model values

R (K/W)	τ (s)
3,88E-02	6,87E+00
6,56E-02	1,33E+00
7,12E-02	8,85E-02
1,67E-02	1,12E-02
7,15E-03	5,40E-04



Boost Switch Characteristics

figure 13. IGBT

Safe operating area
 $I_C = f(V_{CE})$

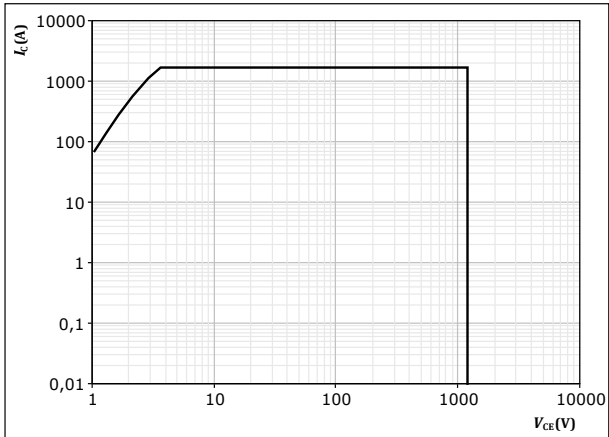

D = single pulse
T_s = 80 °C
V_{GE} = 15 V
T_j = T_{jmax}

figure 14. IGBT

Gate voltage vs gate charge
 $V_{GE} = f(Q_g)$

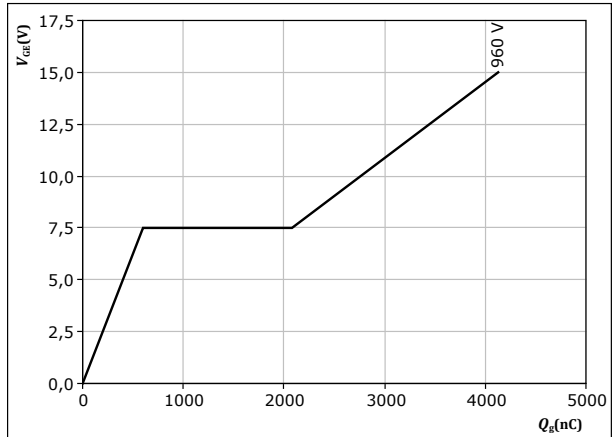

I_C = 560 A
T_j = 25 °C



Boost Diode Characteristics

figure 15. FWD

Typical forward characteristics

$$I_F = f(V_F)$$

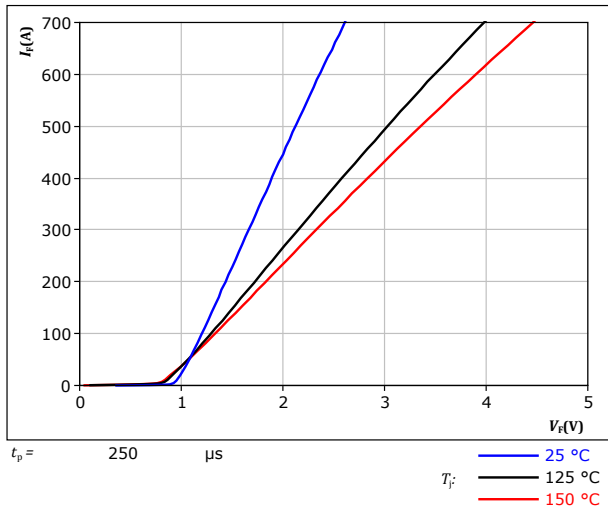
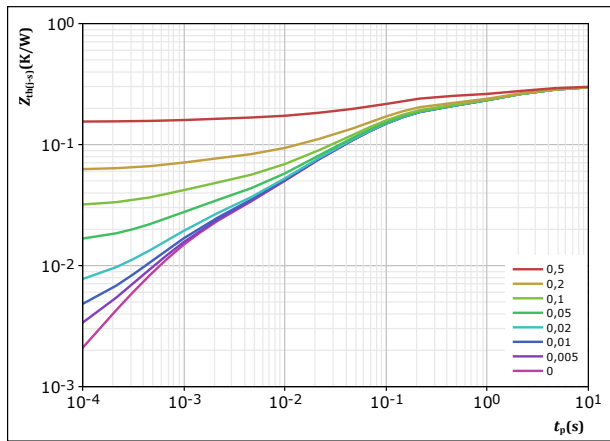

figure 16. FWD

Transient thermal impedance as a function of pulse width

$$Z_{th(j-s)} = f(t_p)$$



$D = t_p / T$
 $R_{th(j-s)} = 0,3 \text{ K/W}$
 FWD thermal model values

R (K/W)	τ (s)
3,83E-02	8,10E+00
8,96E-02	1,32E+00
1,33E-01	8,16E-02
3,22E-02	1,19E-02
1,60E-02	9,15E-04



Boost Sw. Inv. Diode Characteristics

figure 17. FWD

Typical forward characteristics

$$I_F = f(V_F)$$

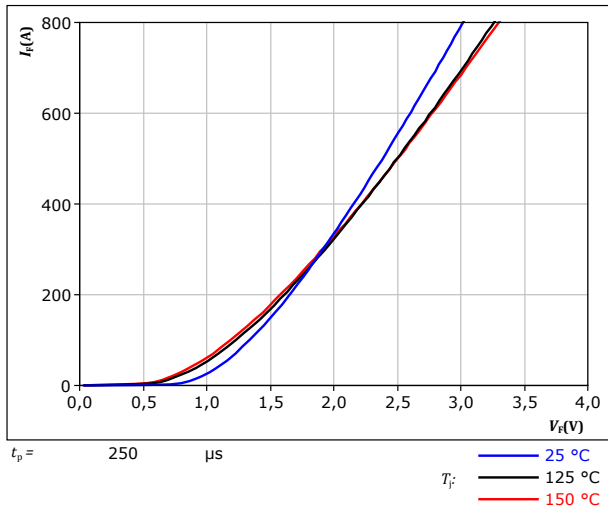
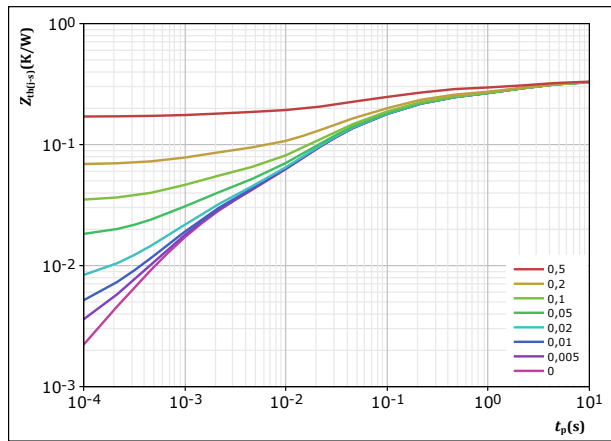

figure 18. FWD

Transient thermal impedance as a function of pulse width

$$Z_{th(j-s)} = f(t_p)$$



$D = t_p / T$

$R_{th(j-s)} = 0,331 \text{ K/W}$

FWD thermal model values

R (K/W)	τ (s)
3,16E-02	1,00E+01
7,88E-02	1,75E+00
1,21E-01	1,25E-01
8,68E-02	2,27E-02
2,22E-02	1,23E-03



Thermistor Characteristics

figure 19. Thermistor

Typical NTC characteristic as function of temperature
 $R_T = f(T)$

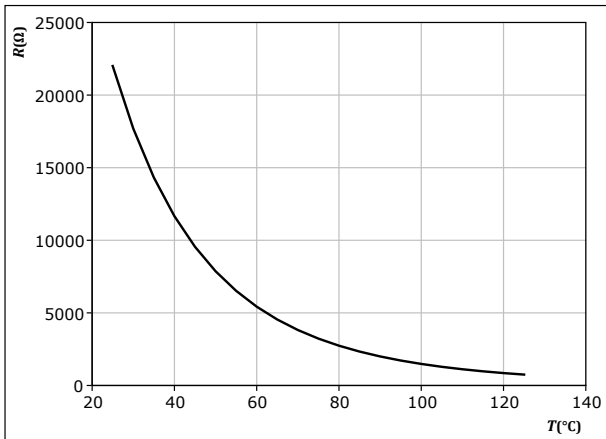



Buck Switching Characteristics

figure 20. IGBT

Typical switching energy losses as a function of collector current
 $E = f(I_c)$

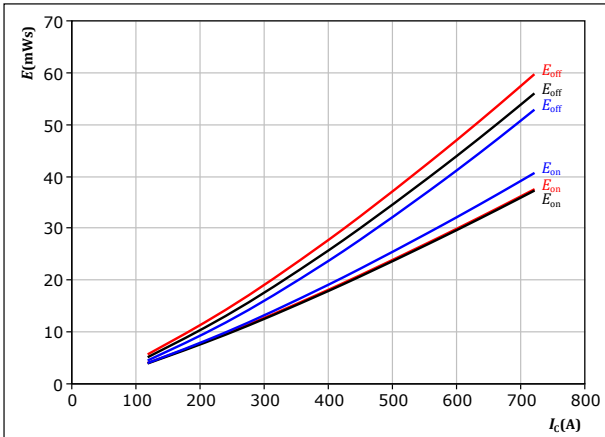

With an inductive load at
 $V_{CE} = 600 \text{ V}$
 $V_{GE} = -10/15 \text{ V}$
 $R_{gon} = 5,82 \ \Omega$
 $R_{goff} = 12,8 \ \Omega$

T_j : 25 °C (blue), 125 °C (black), 150 °C (red)

figure 21. IGBT

Typical switching energy losses as a function of IGBT turn on gate resistor
 $E = f(R_g)$

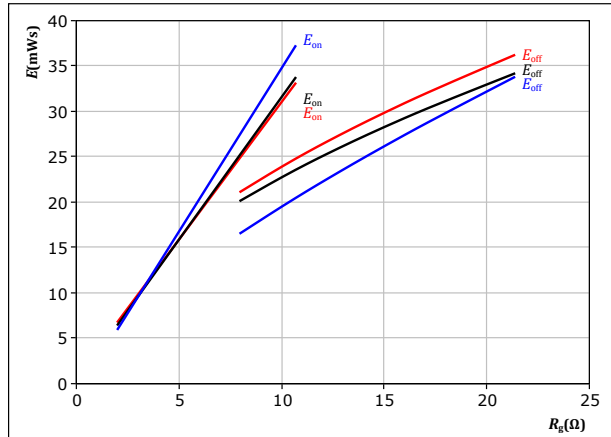

With an inductive load at
 $V_{CE} = 600 \text{ V}$
 $V_{GE} = -10/15 \text{ V}$
 $I_c = 400 \text{ A}$

T_j : 25 °C (blue), 125 °C (black), 150 °C (red)

figure 22. FWD

Typical reverse recovered energy loss as a function of collector current
 $E_{rec} = f(I_c)$

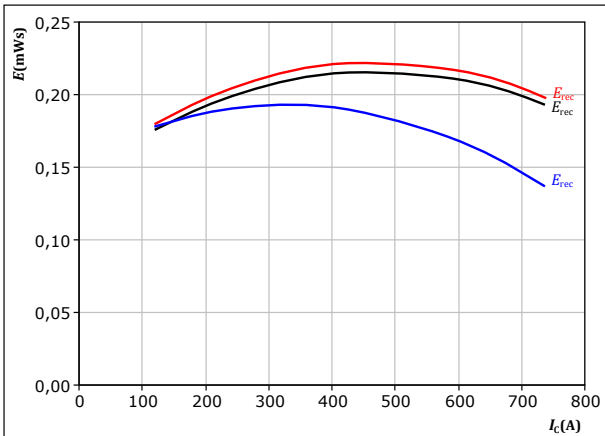

With an inductive load at
 $V_{CE} = 600 \text{ V}$
 $V_{GE} = -10/15 \text{ V}$
 $R_{gon} = 5,82 \ \Omega$

T_j : 25 °C (blue), 125 °C (black), 150 °C (red)

figure 23. FWD

Typical reverse recovered energy loss as a function of IGBT turn on gate resistor
 $E_{rec} = f(R_g)$

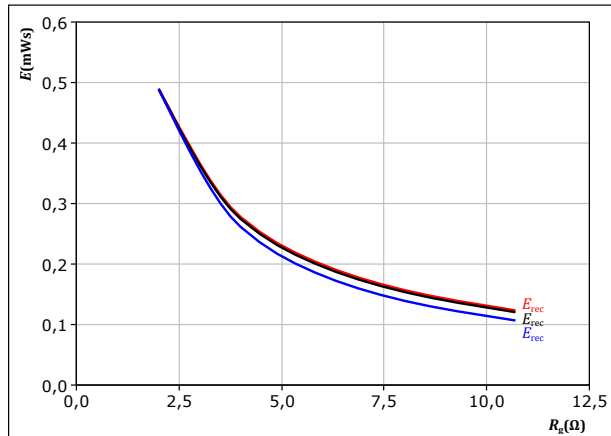

With an inductive load at
 $V_{CE} = 600 \text{ V}$
 $V_{GE} = -10/15 \text{ V}$
 $I_c = 400 \text{ A}$

T_j : 25 °C (blue), 125 °C (black), 150 °C (red)



Buck Switching Characteristics

figure 24. IGBT

Typical switching times as a function of collector current
 $t = f(I_c)$

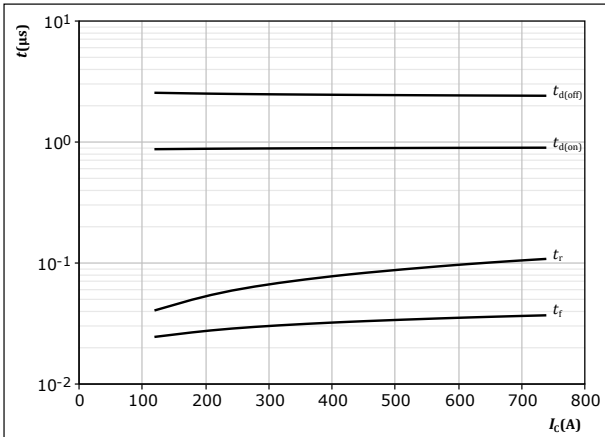

With an inductive load at
 $T_j = 150 \text{ }^\circ\text{C}$
 $V_{CE} = 600 \text{ V}$
 $V_{GE} = -10/15 \text{ V}$
 $R_{gon} = 5,82 \text{ } \Omega$
 $R_{goff} = 12,8 \text{ } \Omega$

figure 25. IGBT

Typical switching times as a function of IGBT turn on gate resistor
 $t = f(R_g)$

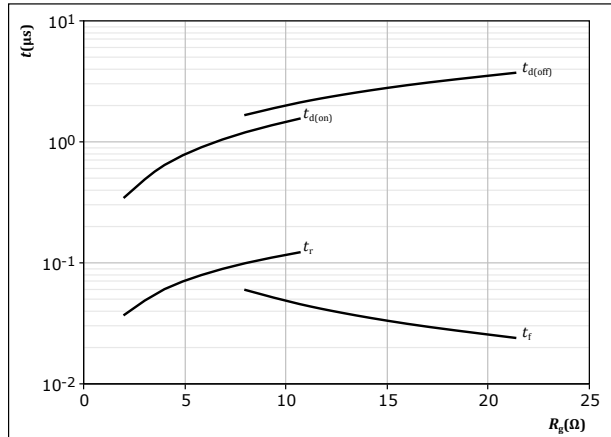

With an inductive load at
 $T_j = 150 \text{ }^\circ\text{C}$
 $V_{CE} = 600 \text{ V}$
 $V_{GE} = -10/15 \text{ V}$
 $I_c = 400 \text{ A}$

figure 26. FWD

Typical reverse recovery time as a function of collector current
 $t_{rr} = f(I_c)$

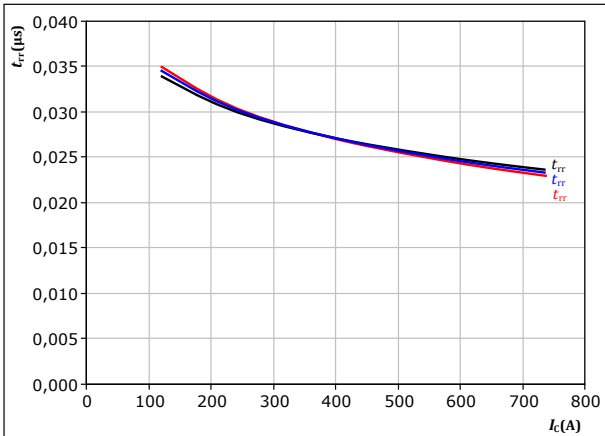

With an inductive load at
 $V_{CE} = 600 \text{ V}$
 $V_{GE} = -10/15 \text{ V}$
 $R_{gon} = 5,82 \text{ } \Omega$
 $T_j:$ — 25 °C
— 125 °C
— 150 °C

figure 27. FWD

Typical reverse recovery time as a function of IGBT turn on gate resistor
 $t_{rr} = f(R_{gon})$

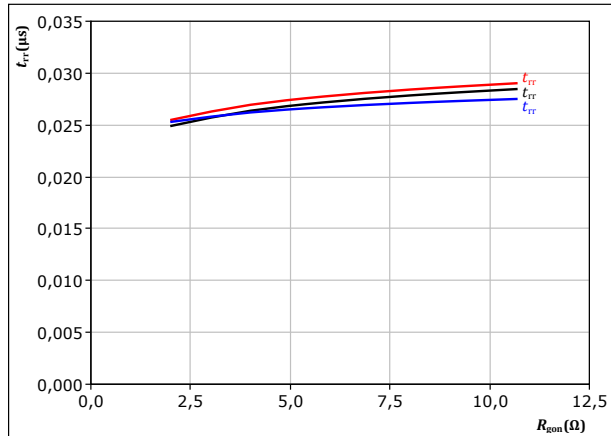

With an inductive load at
 $V_{CE} = 600 \text{ V}$
 $V_{GE} = -10/15 \text{ V}$
 $I_c = 400 \text{ A}$
 $T_j:$ — 25 °C
— 125 °C
— 150 °C



Buck Switching Characteristics

figure 28. FWD

Typical recovered charge as a function of collector current

$$Q_r = f(I_c)$$

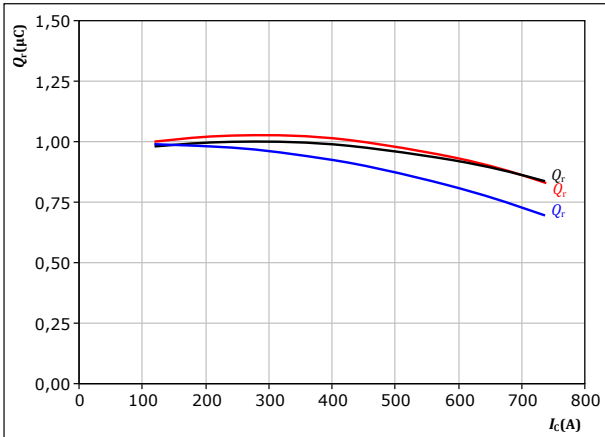

With an inductive load at

$V_{CE} = 600 \text{ V}$
 $V_{GE} = -10/15 \text{ V}$
 $R_{gon} = 5,82 \ \Omega$

T_j : — 25 °C
— 125 °C
— 150 °C

figure 29. FWD

Typical recovered charge as a function of IGBT turn on gate resistor

$$Q_r = f(R_{gon})$$

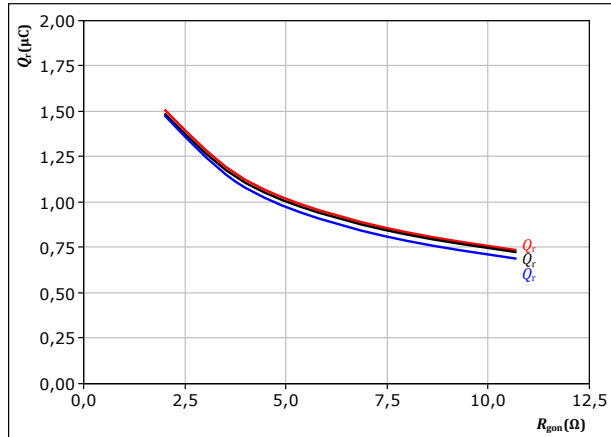

With an inductive load at

$V_{CE} = 600 \text{ V}$
 $V_{GE} = -10/15 \text{ V}$
 $I_c = 400 \text{ A}$

T_j : — 25 °C
— 125 °C
— 150 °C

figure 30. FWD

Typical peak reverse recovery current as a function of collector current

$$I_{RM} = f(I_c)$$

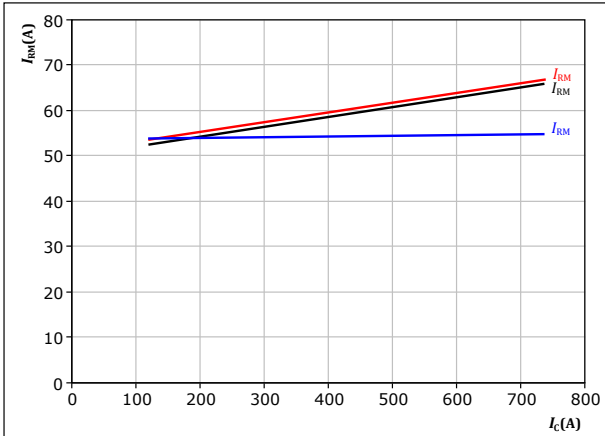

With an inductive load at

$V_{CE} = 600 \text{ V}$
 $V_{GE} = -10/15 \text{ V}$
 $R_{gon} = 5,82 \ \Omega$

T_j : — 25 °C
— 125 °C
— 150 °C

figure 31. FWD

Typical peak reverse recovery current as a function of IGBT turn on gate resistor

$$I_{RM} = f(R_{gon})$$

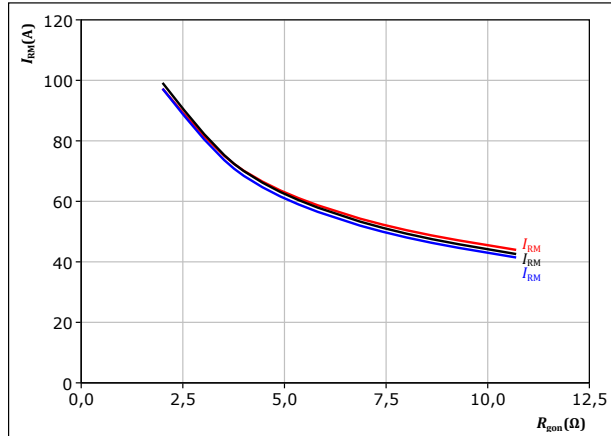

With an inductive load at

$V_{CE} = 600 \text{ V}$
 $V_{GE} = -10/15 \text{ V}$
 $I_c = 400 \text{ A}$

T_j : — 25 °C
— 125 °C
— 150 °C



Buck Switching Characteristics

figure 32. FWD

Typical rate of fall of forward and reverse recovery current as a function of collector current
 $di_f/dt, di_{rr}/dt = f(I_c)$

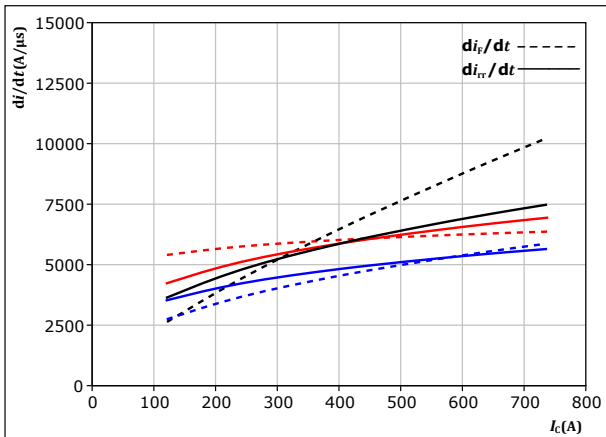

With an inductive load at

$V_{CE} = 600$ V	$T_j = 25$ °C
$V_{GE} = -10/15$ V	$T_j = 125$ °C
$R_{gon} = 5,82$ Ω	$T_j = 150$ °C

figure 33. FWD

Typical rate of fall of forward and reverse recovery current as a function of turn on gate resistor
 $di_f/dt, di_{rr}/dt = f(R_{gon})$

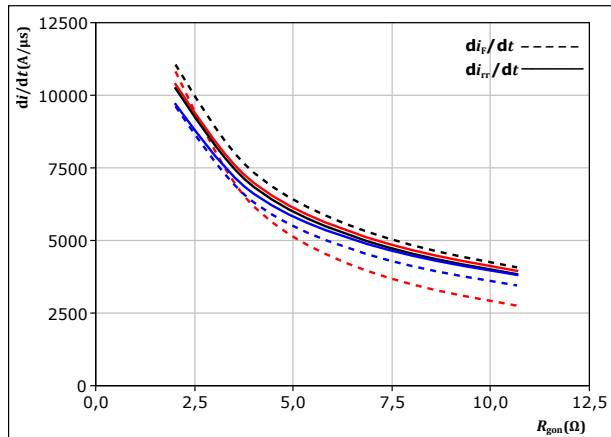

With an inductive load at

$V_{CE} = 600$ V	$T_j = 25$ °C
$V_{GE} = -10/15$ V	$T_j = 125$ °C
$I_c = 400$ A	$T_j = 150$ °C

figure 34. IGBT

Reverse bias safe operating area
 $I_c = f(V_{CE})$

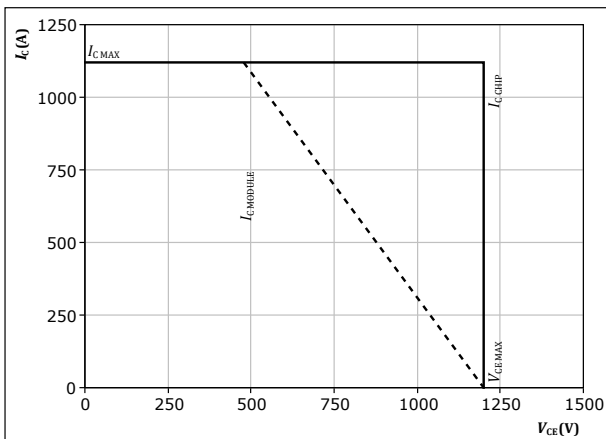

At $T_j = 150$ °C
 $R_{gon} = 5,82$ Ω
 $R_{goff} = 12,8$ Ω



Boost Switching Characteristics

figure 35. IGBT

Typical switching energy losses as a function of collector current
 $E = f(I_c)$

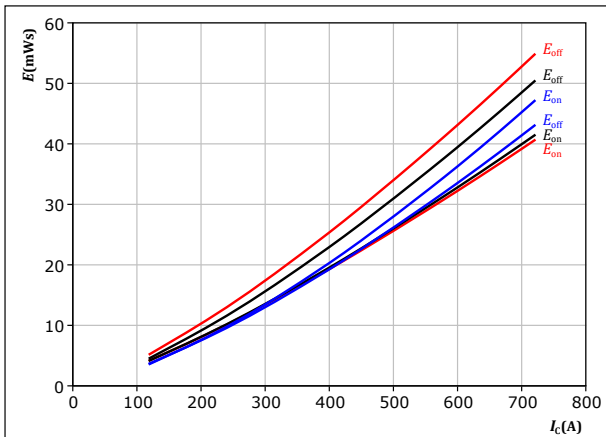

With an inductive load at
 $V_{CE} = 600 \text{ V}$
 $V_{GE} = -10/15 \text{ V}$
 $R_{gon} = 5,95 \ \Omega$
 $R_{goff} = 12,19 \ \Omega$

T_j :
— 25 °C
— 125 °C
— 150 °C

figure 36. IGBT

Typical switching energy losses as a function of IGBT turn on gate resistor
 $E = f(R_g)$

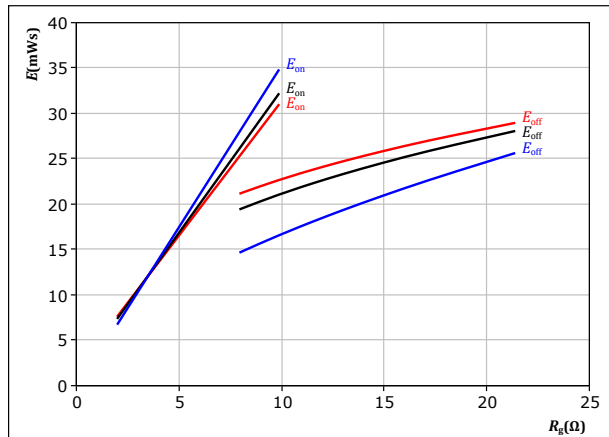

With an inductive load at
 $V_{CE} = 600 \text{ V}$
 $V_{GE} = -10/15 \text{ V}$
 $I_c = 400 \text{ A}$

T_j :
— 25 °C
— 125 °C
— 150 °C

figure 37. FWD

Typical reverse recovered energy loss as a function of collector current
 $E_{rec} = f(I_c)$

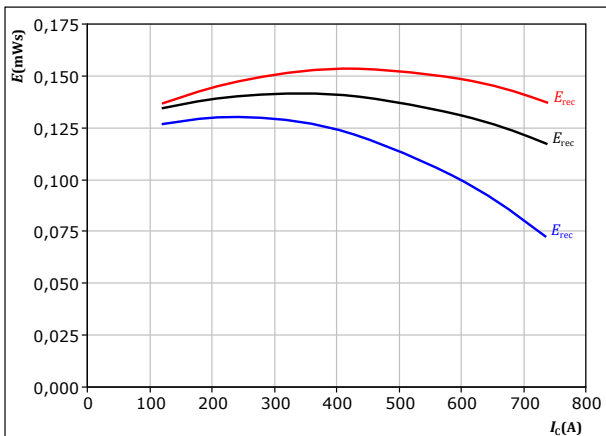

With an inductive load at
 $V_{CE} = 600 \text{ V}$
 $V_{GE} = -10/15 \text{ V}$
 $R_{gon} = 5,95 \ \Omega$

T_j :
— 25 °C
— 125 °C
— 150 °C

figure 38. FWD

Typical reverse recovered energy loss as a function of IGBT turn on gate resistor
 $E_{rec} = f(R_g)$

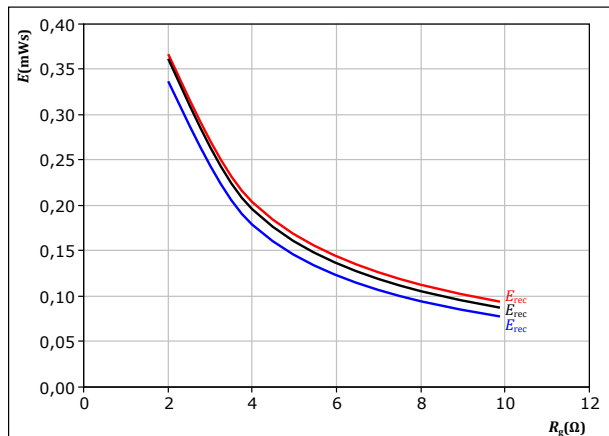

With an inductive load at
 $V_{CE} = 600 \text{ V}$
 $V_{GE} = -10/15 \text{ V}$
 $I_c = 400 \text{ A}$

T_j :
— 25 °C
— 125 °C
— 150 °C



Boost Switching Characteristics

figure 39. IGBT

Typical switching times as a function of collector current
 $t = f(I_c)$

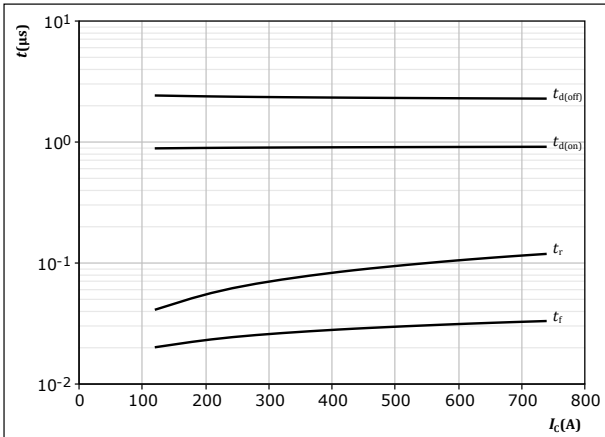

With an inductive load at
 $T_j = 150 \text{ }^\circ\text{C}$
 $V_{CE} = 600 \text{ V}$
 $V_{GE} = -10/15 \text{ V}$
 $R_{gon} = 5,95 \text{ } \Omega$
 $R_{goff} = 12,19 \text{ } \Omega$

figure 40. IGBT

Typical switching times as a function of IGBT turn on gate resistor
 $t = f(R_g)$

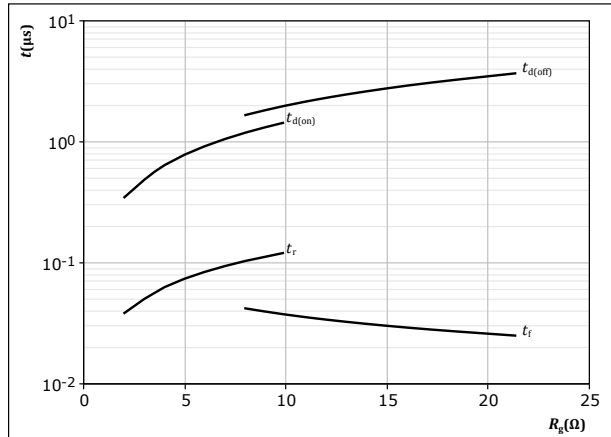

With an inductive load at
 $T_j = 150 \text{ }^\circ\text{C}$
 $V_{CE} = 600 \text{ V}$
 $V_{GE} = -10/15 \text{ V}$
 $I_c = 400 \text{ A}$

figure 41. FWD

Typical reverse recovery time as a function of collector current
 $t_{rr} = f(I_c)$

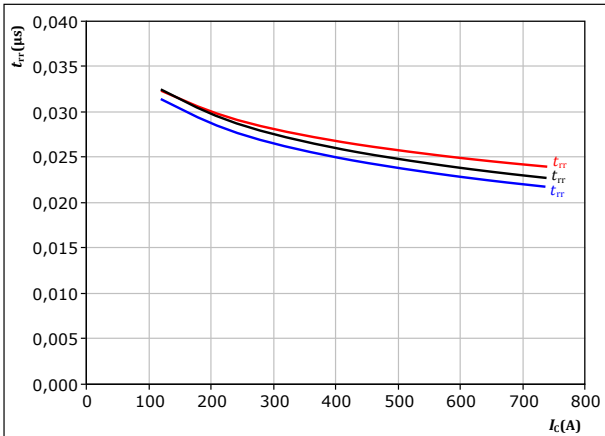

With an inductive load at
 $V_{CE} = 600 \text{ V}$
 $V_{GE} = -10/15 \text{ V}$
 $R_{gon} = 5,95 \text{ } \Omega$
 $T_j:$ — 25 °C
 — 125 °C
 — 150 °C

figure 42. FWD

Typical reverse recovery time as a function of IGBT turn on gate resistor
 $t_{rr} = f(R_{gon})$

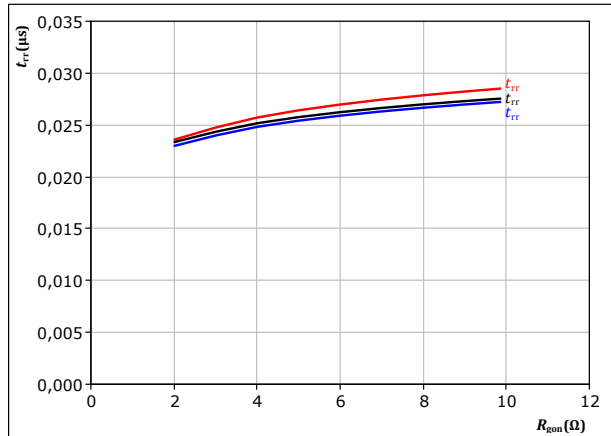

With an inductive load at
 $V_{CE} = 600 \text{ V}$
 $V_{GE} = -10/15 \text{ V}$
 $I_c = 400 \text{ A}$
 $T_j:$ — 25 °C
 — 125 °C
 — 150 °C



Boost Switching Characteristics

figure 43. FWD

Typical recovered charge as a function of collector current

$$Q_r = f(I_c)$$

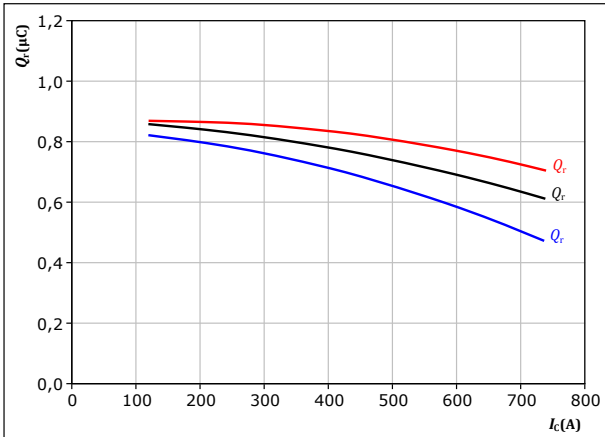

With an inductive load at

$V_{CE} = 600 \text{ V}$
 $V_{GE} = -10/15 \text{ V}$
 $R_{gon} = 5,95 \ \Omega$

T_j :
— 25 °C
— 125 °C
— 150 °C

figure 44. FWD

Typical recovered charge as a function of IGBT turn on gate resistor

$$Q_r = f(R_{gon})$$

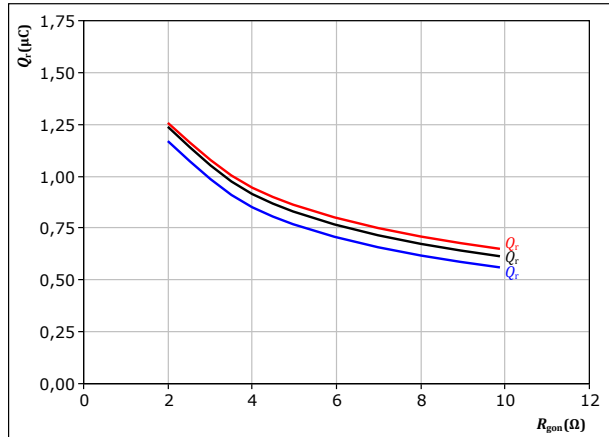

With an inductive load at

$V_{CE} = 600 \text{ V}$
 $V_{GE} = -10/15 \text{ V}$
 $I_c = 400 \text{ A}$

T_j :
— 25 °C
— 125 °C
— 150 °C

figure 45. FWD

Typical peak reverse recovery current as a function of collector current

$$I_{RM} = f(I_c)$$

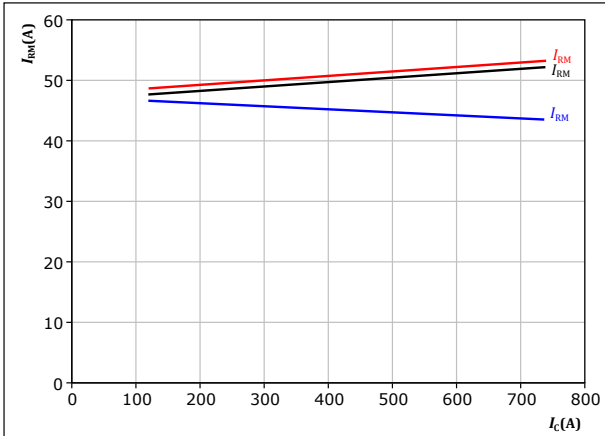

With an inductive load at

$V_{CE} = 600 \text{ V}$
 $V_{GE} = -10/15 \text{ V}$
 $R_{gon} = 5,95 \ \Omega$

T_j :
— 25 °C
— 125 °C
— 150 °C

figure 46. FWD

Typical peak reverse recovery current as a function of IGBT turn on gate resistor

$$I_{RM} = f(R_{gon})$$

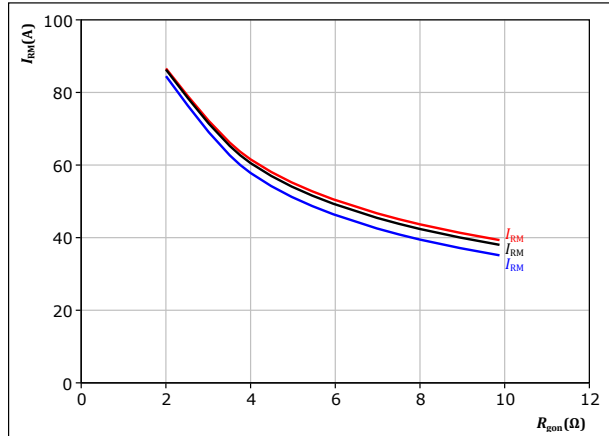

With an inductive load at

$V_{CE} = 600 \text{ V}$
 $V_{GE} = -10/15 \text{ V}$
 $I_c = 400 \text{ A}$

T_j :
— 25 °C
— 125 °C
— 150 °C



Boost Switching Characteristics

figure 47. FWD

Typical rate of fall of forward and reverse recovery current as a function of collector current
 $di_i/dt, di_r/dt = f(I_c)$

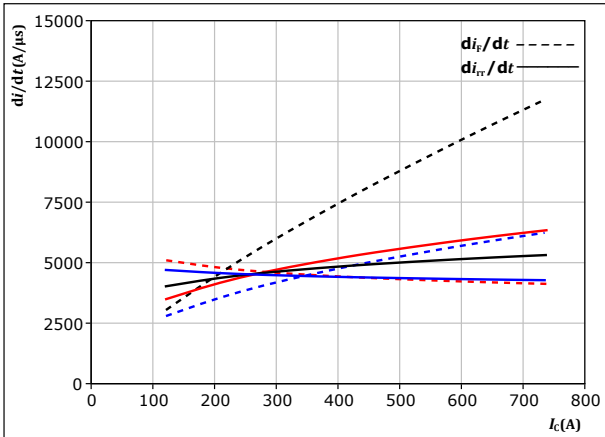

With an inductive load at

$V_{CE} = 600$ V
 $V_{GE} = -10/15$ V
 $R_{gon} = 5,95$ Ω

T_j : 25 °C
 125 °C
 150 °C

figure 48. FWD

Typical rate of fall of forward and reverse recovery current as a function of turn on gate resistor
 $di_i/dt, di_r/dt = f(R_{gon})$

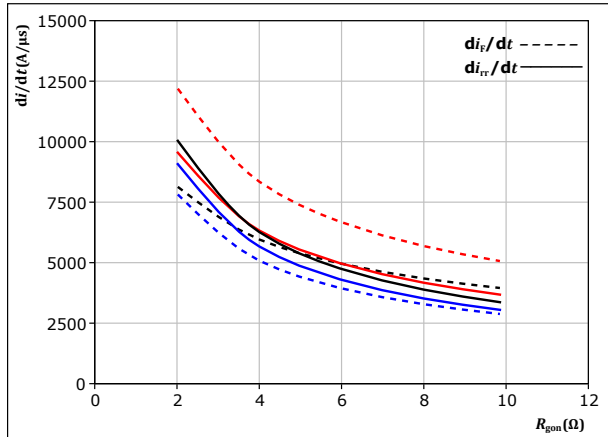

With an inductive load at

$V_{CE} = 600$ V
 $V_{GE} = -10/15$ V
 $I_c = 400$ A

T_j : 25 °C
 125 °C
 150 °C

figure 49. IGBT

Reverse bias safe operating area

$I_c = f(V_{CE})$

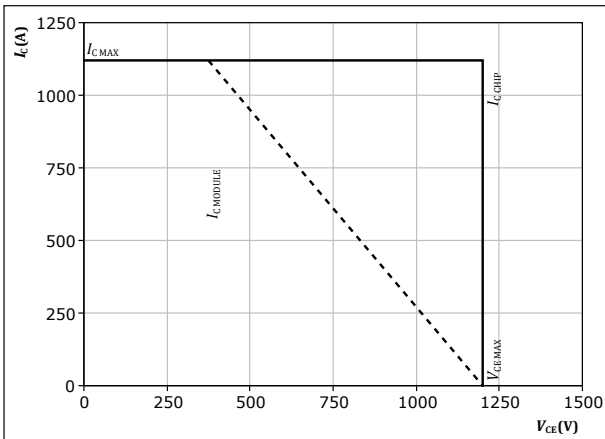

At $T_j = 150$ °C
 $R_{gon} = 5,95$ Ω
 $R_{goff} = 12,19$ Ω



Switching Definitions

figure 50. IGBT

Turn-off Switching Waveforms & definition of t_{doff} , t_{Eoff} (t_{Eoff} = integrating time for E_{off})

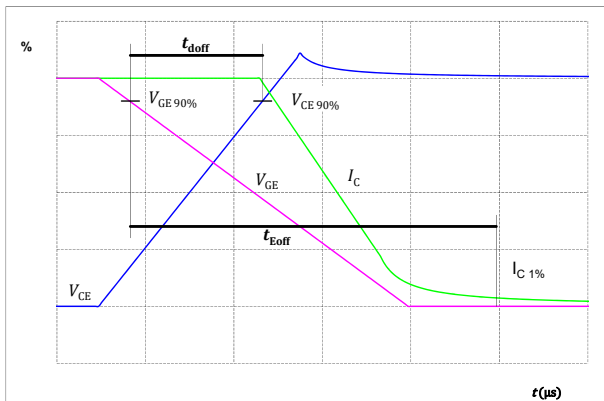

figure 51. IGBT

Turn-on Switching Waveforms & definition of t_{don} , t_{Eon} (t_{Eon} = integrating time for E_{on})

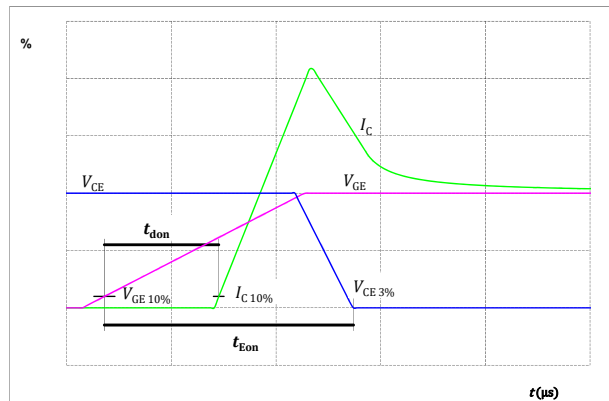

figure 52. IGBT

Turn-off Switching Waveforms & definition of t_f

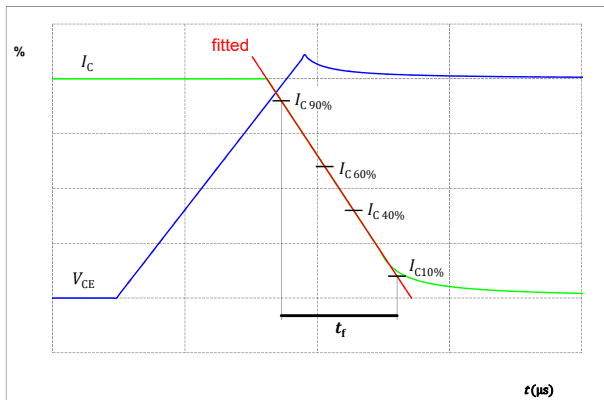
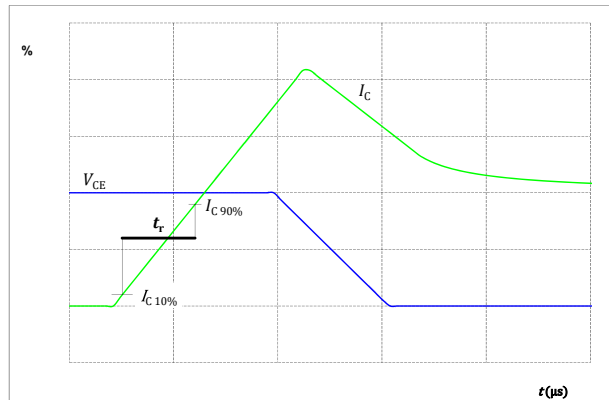

figure 53. IGBT

Turn-on Switching Waveforms & definition of t_r





Switching Definitions

figure 54. FWD

Turn-off Switching Waveforms & definition of t_{rr}

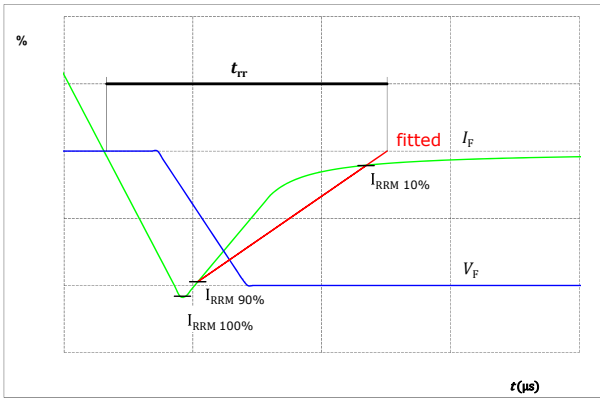
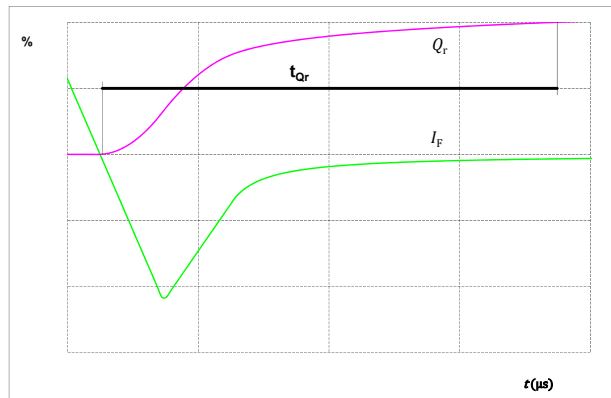
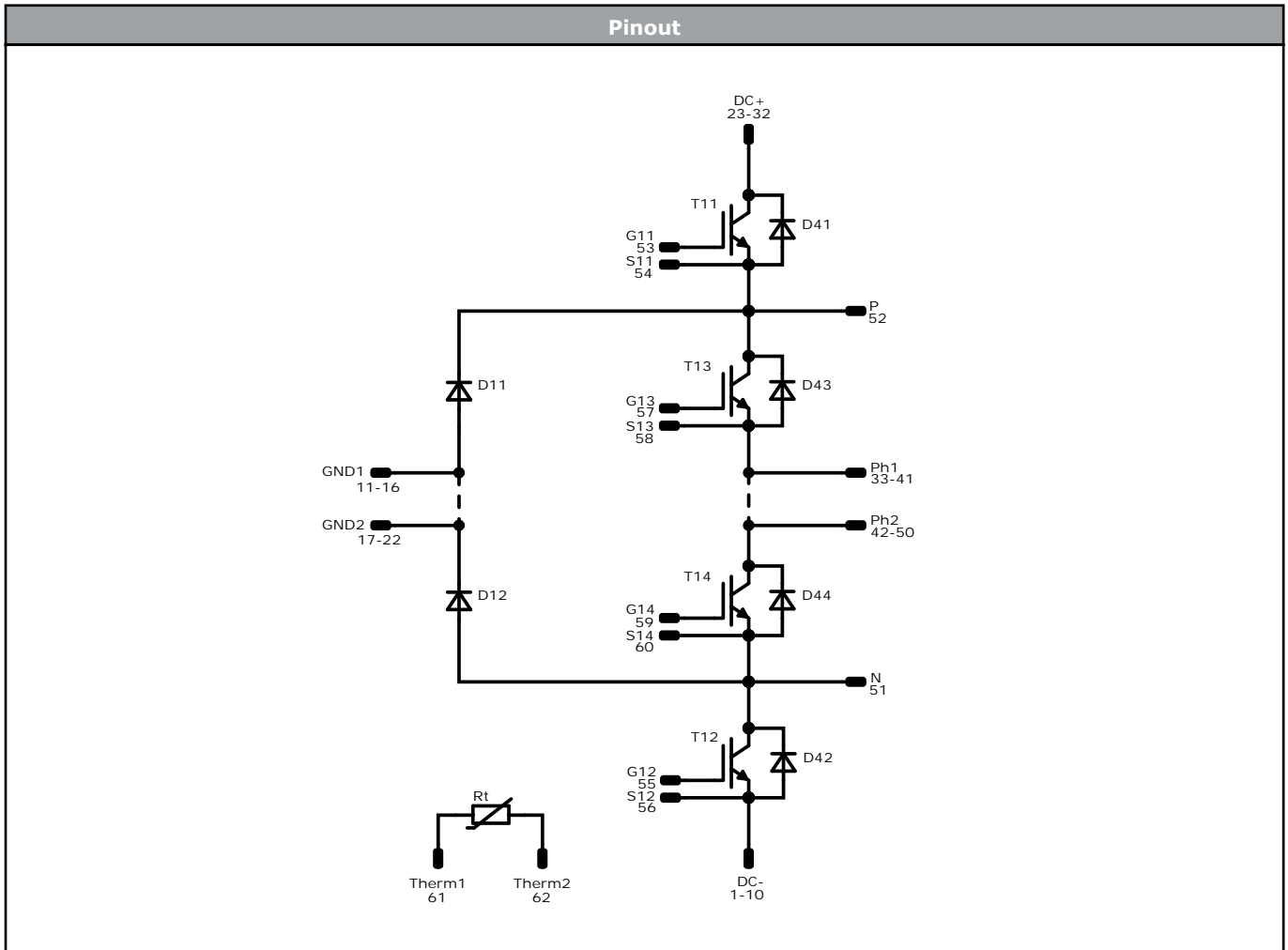

figure 55. FWD

Turn-on Switching Waveforms & definition of t_{Qr} (t_{Qr} = integrating time for Q_r)





Identification					
ID	Component	Voltage	Current	Function	Comment
T11, T12	IGBT	1200 V	560 A	Buck Switch	
D11, D12	FWD	1200 V	240 A	Buck Diode	
T13, T14	IGBT	1200 V	560 A	Boost Switch	
D42, D41	FWD	1200 V	240 A	Boost Diode	
D43, D44	FWD	1200 V	300 A	Boost Sw. Inv. Diode	
Rt	Thermistor			Thermistor	



Vincotech

Packaging instruction				
Standard packaging quantity (SPQ) 24	>SPQ	Standard	<SPQ	Sample

Handling instruction
Handling instructions for <i>flow</i> E3BP packages see vincotech.com website.

Package data
Package data for <i>flow</i> E3BP packages see vincotech.com website.

Vincotech thermistor reference
See Vincotech thermistor reference table at vincotech.com website.

UL recognition and file number
This device is UL 1557 recognized under E192116 up to a junction temperature under switching condition $T_{j,op}=175^{\circ}\text{C}$ and up to 4000VAC/1min isolation voltage. For more information see vincotech.com website.



Document No.:	Date:	Modification:	Pages
30-E312NIC560H7-PU10F57Z-D2-14	22 Apr. 2026	Extend current range of dynamic characteristics	
30-E312NIC560H7-PU10F57Z-D3-14	14 May. 2026	New dynamic characteristics	

DISCLAIMER

The information, specifications, procedures, methods and recommendations herein (together "information") are presented by Vincotech to reader in good faith, are believed to be accurate and reliable, but may well be incomplete and/or not applicable to all conditions or situations that may exist or occur. Vincotech reserves the right to make any changes without further notice to any products to improve reliability, function or design. No representation, guarantee or warranty is made to reader as to the accuracy, reliability or completeness of said information or that the application or use of any of the same will avoid hazards, accidents, losses, damages or injury of any kind to persons or property or that the same will not infringe third parties rights or give desired results. It is reader's sole responsibility to test and determine the suitability of the information and the product for reader's intended use.

LIFE SUPPORT POLICY

Vincotech products are not authorised for use as critical components in life support devices or systems without the express written approval of Vincotech.

As used herein:

1. Life support devices or systems are devices or systems which, (a) are intended for surgical implant into the body, or (b) support or sustain life, or (c) whose failure to perform when properly used in accordance with instructions for use provided in labelling can be reasonably expected to result in significant injury to the user.
2. A critical component is any component of a life support device or system whose failure to perform can be reasonably expected to cause the failure of the life support device or system, or to affect its safety or effectiveness.