



**flowPIM 1 + PFC**

**600 V / 30 A**

**Topology features**

- 3x Shunts
- Converter + 2-leg interleaved PFC + Inverter
- On-board Capacitors
- Open Emitter configuration
- Temperature sensor

**Component features**

- 5us short circuit withstand time
- High speed switching
- Low EMI
- Short tail current

**Housing features**

- Base isolation: Al<sub>2</sub>O<sub>3</sub>
- Convex shaped substrate for superior thermal contact
- Thermo-mechanical push-and-pull force relief
- Press-fit pin
- Reliable cold welding connection

**Target applications**

- Embedded Drives
- Industrial Drives

**Types**

- 10-PG06PPA030SJ04-LJ02B03T

**flow 1 12 mm housing**

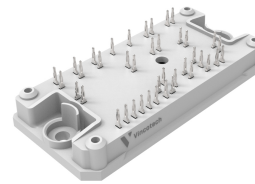

**Schematic**

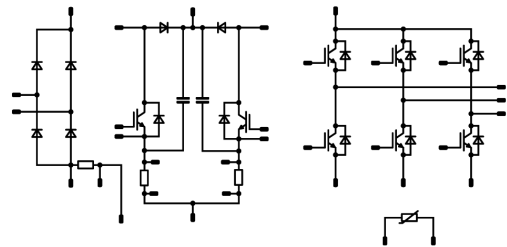



Vincotech

10-PG06PPA030SJ04-LJ02B03T  
datasheet

## Maximum Ratings

$T_j = 25\text{ °C}$ , unless otherwise specified

Parameter	Symbol	Conditions	Value	Unit
<b>Inverter Switch</b>				
Collector-emitter voltage	$V_{CES}$		600	V
Collector current (DC current)	$I_C$	$T_j = T_{jmax}$ $T_s = 80\text{ °C}$	30	A
Repetitive peak collector current	$I_{CRM}$	$t_p$ limited by $T_{jmax}$	90	A
Total power dissipation	$P_{tot}$	$T_j = T_{jmax}$ $T_s = 80\text{ °C}$	63	W
Gate-emitter voltage	$V_{GES}$		$\pm 20$	V
Short circuit ratings	$t_{SC}$	$V_{GE} = 15\text{ V}$ , $V_{CC} = 400\text{ V}$ $T_j = 150\text{ °C}$	5	$\mu\text{s}$
Maximum junction temperature	$T_{jmax}$		175	$^{\circ}\text{C}$

## Inverter Diode

Peak repetitive reverse voltage	$V_{RRM}$		600	V
Forward current (DC current)	$I_F$	$T_j = T_{jmax}$ $T_s = 80\text{ °C}$	28	A
Repetitive peak forward current	$I_{FRM}$	$t_p$ limited by $T_{jmax}$	40	A
Total power dissipation	$P_{tot}$	$T_j = T_{jmax}$ $T_s = 80\text{ °C}$	50	W
Maximum junction temperature	$T_{jmax}$		175	$^{\circ}\text{C}$

## PFC Switch

Collector-emitter voltage	$V_{CES}$		650	V
Collector current (DC current)	$I_C$	$T_j = T_{jmax}$ $T_s = 80\text{ °C}$	29	A
Repetitive peak collector current	$I_{CRM}$	$t_p$ limited by $T_{jmax}$	90	A
Total power dissipation	$P_{tot}$	$T_j = T_{jmax}$ $T_s = 80\text{ °C}$	68	W
Gate-emitter voltage	$V_{GES}$		$\pm 20$	V
Maximum junction temperature	$T_{jmax}$		175	$^{\circ}\text{C}$



Vincotech

## Maximum Ratings

$T_j = 25\text{ °C}$ , unless otherwise specified

Parameter	Symbol	Conditions	Value	Unit
<b>PFC Diode</b>				
Peak repetitive reverse voltage	$V_{RRM}$		600	V
Forward current (DC current)	$I_F$	$T_j = T_{jmax}$ $T_s = 80\text{ °C}$	46	A
Repetitive peak forward current	$I_{FRM}$	$t_p$ limited by $T_{jmax}$	60	A
Surge (non-repetitive) forward current	$I_{FSM}$	Single Half Sine Wave, $t_p = 10\text{ ms}$ $T_j = 25\text{ °C}$	310	A
Total power dissipation	$P_{tot}$	$T_j = T_{jmax}$ $T_s = 80\text{ °C}$	60	W
Maximum junction temperature	$T_{jmax}$		175	°C

## PFC Sw. Protection Diode

Peak repetitive reverse voltage	$V_{RRM}$		650	V
Forward current (DC current)	$I_F$	$T_j = T_{jmax}$ $T_s \leq 80\text{ °C}$	12 <sup>(1)</sup>	A
Repetitive peak forward current	$I_{FRM}$	$t_p$ limited by $T_{jmax}$	12	A
Total power dissipation	$P_{tot}$	$T_j = T_{jmax}$ $T_s = 80\text{ °C}$	38	W
Maximum junction temperature	$T_{jmax}$		175	°C

<sup>(1)</sup> limited by  $I_{FRM}$

## Rectifier Diode

Peak repetitive reverse voltage	$V_{RRM}$		1600	V
Forward current (DC current)	$I_F$	$T_j = T_{jmax}$ $T_s = 80\text{ °C}$	50	A
Surge (non-repetitive) forward current	$I_{FSM}$	Single Half Sine Wave, $t_p = 10\text{ ms}$ $T_j = 150\text{ °C}$	270	A
Surge current capability	$I^2t$		365	A <sup>2</sup> s
Total power dissipation	$P_{tot}$	$T_j = T_{jmax}$ $T_s = 80\text{ °C}$	64	W
Maximum junction temperature	$T_{jmax}$		150	°C

## PFC Shunt

DC current	$I$		20	A
Power dissipation	$P_{tot}$	$T_c = 70\text{ °C}$	2	W
Operation Temperature	$T_{op}$		-65 ... 170	°C



Vincotech

**10-PG06PPA030SJ04-LJ02B03T**  
datasheet

## Maximum Ratings

$T_j = 25\text{ °C}$ , unless otherwise specified

Parameter	Symbol	Conditions	Value	Unit
<b>Shunt</b>				
DC current	$I$		20	A
Power dissipation	$P_{tot}$	$T_c = 70\text{ °C}$	2	W
Operation Temperature	$T_{op}$		-65 ... 170	°C

## Capacitor (PFC)

Maximum DC voltage	$V_{MAX}$		630	V
Operation Temperature	$T_{op}$		-55 ... 150	°C

## Module Properties

### Thermal Properties

Storage temperature	$T_{stg}$		-40...+125	°C
Operation temperature under switching condition	$T_{jop}$		$-40...+(T_{jmax} - 25)$	°C

### Isolation Properties

Isolation voltage	$V_{isol}$	DC Test Voltage* $t_p = 2\text{ s}$	6000	V
Isolation voltage	$V_{isol}$	AC Voltage $t_p = 1\text{ min}$	2500	V
Creepage distance			>12,7	mm
Clearance			7,82	mm
Comparative Tracking Index	CTI		≥ 600	

\*100 % tested in production



Vincotech

### Characteristic Values

Parameter	Symbol	Conditions					Values			Unit
		$V_{GS}$ [V]	$V_{GE}$ [V]	$V_{DS}$ [V]	$I_D$ [A]	$T_j$ [°C]	Min	Typ	Max	

#### Inverter Switch

##### Static

Gate-emitter threshold voltage	$V_{GE(th)}$	$V_{CE} = V_{GE}$			0,00048	25	4,1	5,1	5,7	V
Collector-emitter saturation voltage	$V_{CE(sat)}$		15		30	25 125 150		1,73 1,97 2,01	1,8 <sup>(2)</sup>	V
Collector-emitter cut-off current	$I_{CES}$		0	600		25			1,6	μA
Gate-emitter leakage current	$I_{GES}$		20	0		25			100	nA
Internal gate resistance	$r_g$							None		Ω
Input capacitance	$C_{ies}$							1050		pF
Output capacitance	$C_{oes}$	$f = 1$ Mhz	0	25		25		45		pF
Reverse transfer capacitance	$C_{res}$							36		pF
Gate charge	$Q_g$	$V_{CC} = 480$ V	15		30	25		130		nC

##### Thermal

Thermal resistance junction to sink <sup>(3)</sup>	$R_{th(j-s)}$	$\lambda_{paste} = 3,4$ W/mK (PSX)						1,52		K/W
--	---------------	------------------------------------	--	--	--	--	--	------	--	-----

##### Dynamic

Turn-on delay time	$t_{d(on)}$					25 125 150		37 38 38		ns
Rise time	$t_r$					25 125 150		12 13 15		ns
Turn-off delay time	$t_{d(off)}$					25 125 150		90 109 113		ns
Fall time	$t_f$					25 125 150		12 19,35 23,06		ns
Turn-on energy (per pulse)	$E_{on}$	$Q_{tFWD} = 0,812$ μC $Q_{tFWD} = 1,81$ μC $Q_{tFWD} = 2,02$ μC				25 125 150		0,758 0,981 1,04		mWs
Turn-off energy (per pulse)	$E_{off}$					25 125 150		0,233 0,422 0,469		mWs



Vincotech

10-PG06PPA030SJ04-LJ02B03T  
datasheet

### Characteristic Values

Parameter	Symbol	Conditions					Values			Unit
		$V_{GE}$ [V] $V_{GS}$ [V]	$V_{CE}$ [V] $V_{DS}$ [V] $V_F$ [V]	$I_C$ [A] $I_D$ [A] $I_F$ [A]	$T_j$ [°C]	Min	Typ	Max		
<b>Inverter Diode</b>										
<b>Static</b>										
Forward voltage	$V_F$				20	25 125 150	1,25	1,7 1,58 1,58	1,95 <sup>(2)</sup>	V
Reverse leakage current	$I_R$	$V_i = 600$ V				25			27	μA
<b>Thermal</b>										
Thermal resistance junction to sink <sup>(3)</sup>	$R_{th(j-s)}$	$\lambda_{paste} = 3,4$ W/mK (PSX)						1,91		K/W
<b>Dynamic</b>										
Peak recovery current	$I_{RM}$	$di/dt=500$ A/μs $di/dt=1295$ A/μs $di/dt=1294$ A/μs	±15	350	30	25 125 150		7,86 12,39 13,22		A
Reverse recovery time	$t_{rr}$					25 125 150		200,95 276,23 327,76		ns
Recovered charge	$Q_r$					25 125 150		0,812 1,81 2,02		μC
Reverse recovered energy	$E_{rec}$					25 125 150		0,161 0,388 0,431		mWs
Peak rate of fall of recovery current	$(di_r/dt)_{max}$					25 125 150		53,57 61,27 82,45		A/μs



Vincotech

10-PG06PPA030SJ04-LJ02B03T  
datasheet

### Characteristic Values

Parameter	Symbol	Conditions					Values			Unit
		$V_{GS}$ [V]	$V_{GE}$ [V]	$V_{DS}$ [V]	$V_F$ [V]	$I_C$ [A] $I_D$ [A] $I_F$ [A]	$T_j$ [°C]	Min	Typ	

### PFC Switch

#### Static

Gate-emitter threshold voltage	$V_{GE(th)}$	$V_{CE} = V_{GE}$			0,0003	25	3,3	4	4,7	V
Collector-emitter saturation voltage	$V_{CE(sat)}$		15		30	25 125		1,97 2,25	2,22 <sup>(2)</sup>	V
Collector-emitter cut-off current	$I_{CES}$		0	650		25			40	μA
Gate-emitter leakage current	$I_{GES}$		20	0		25			120	nA
Internal gate resistance	$r_g$							None		Ω
Input capacitance	$C_{ies}$							1800		pF
Output capacitance	$C_{oes}$	$f = 1$ Mhz	0	25		25		45		pF
Reverse transfer capacitance	$C_{res}$							9		pF
Gate charge	$Q_g$	$V_{CC} = 520$ V	15		30	25		65		nC

#### Thermal

Thermal resistance junction to sink <sup>(3)</sup>	$R_{th(j-s)}$	$\lambda_{paste} = 3,4$ W/mK (PSX)						1,39		K/W
--	---------------	---------------------------------------	--	--	--	--	--	------	--	-----

#### Dynamic

Turn-on delay time	$t_{d(on)}$					25 125 150		14,68 14,47 14,12		ns
Rise time	$t_r$					25 125 150		5,04 6,21 6,61		ns
Turn-off delay time	$t_{d(off)}$					25 125 150		84,2 100,34 103,9		ns
Fall time	$t_f$					25 125 150		1,16 3,01 10,29		ns
Turn-on energy (per pulse)	$E_{on}$	$Q_{tFWD} = 0,456$ μC $Q_{tFWD} = 1,34$ μC $Q_{tFWD} = 1,67$ μC				25 125 150		0,295 0,461 0,523		mWs
Turn-off energy (per pulse)	$E_{off}$					25 125 150		0,153 0,241 0,266		mWs



Vincotech

**10-PG06PPA030SJ04-LJ02B03T**  
datasheet

### Characteristic Values

Parameter	Symbol	Conditions					Values			Unit
		$V_{GE}$ [V] $V_{GS}$ [V]	$V_{CE}$ [V] $V_{DS}$ [V] $V_F$ [V]	$I_C$ [A] $I_D$ [A] $I_F$ [A]	$T_j$ [°C]	Min	Typ	Max		

#### PFC Diode

##### Static

Forward voltage	$V_F$				30	25 125 150		1,67 1,33 1,24	2,5 <sup>(2)</sup>	V
Reverse leakage current	$I_R$	$V_T = 600$ V				25			20	μA

##### Thermal

Thermal resistance junction to sink <sup>(3)</sup>	$R_{th(j-s)}$	$\lambda_{paste} = 3,4$ W/mK (PSX)						1,58		K/W
--	---------------	---------------------------------------	--	--	--	--	--	------	--	-----

##### Dynamic

Peak recovery current	$I_{RM}$					25 125 150		47,04 74,4 84,02		A
Reverse recovery time	$t_{rr}$					25 125 150		19,1 37,01 40,23		ns
Recovered charge	$Q_r$	$di/dt=4277$ A/μs $di/dt=4179$ A/μs $di/dt=4332$ A/μs	0/15	400	30	25 125 150		0,456 1,34 1,67		μC
Reverse recovered energy	$E_{rec}$					25 125 150		0,079 0,284 0,364		mWs
Peak rate of fall of recovery current	$(di_r/dt)_{max}$					25 125 150		6342,52 5926,83 5963,38		A/μs





Vincotech

### Characteristic Values

Parameter	Symbol	Conditions					Values			Unit
		$V_{GS}$ [V]	$V_{GE}$ [V]	$V_{DS}$ [V]	$V_{CE}$ [V]	$T_j$ [°C]	Min	Typ	Max	

#### PFC Sw. Protection Diode

##### Static

Forward voltage	$V_F$				6	25 125 150	1,23	1,72 1,58 1,54	1,87 <sup>(2)</sup>	V
Reverse leakage current	$I_R$	$V_r = 650$ V				25			0,1	μA

##### Thermal

Thermal resistance junction to sink <sup>(3)</sup>	$R_{th(j-s)}$	$\lambda_{paste} = 3,4$ W/mK (PSX)						2,53		K/W
--	---------------	------------------------------------	--	--	--	--	--	------	--	-----

#### Rectifier Diode

##### Static

Forward voltage	$V_F$				50	25 125 150		1,27 1,27	1,3 <sup>(2)</sup> 1,37 <sup>(2)</sup>	V
Reverse leakage current	$I_R$	$V_r = 1600$ V				25 150			20 1500	μA

##### Thermal

Thermal resistance junction to sink <sup>(3)</sup>	$R_{th(j-s)}$	$\lambda_{paste} = 3,4$ W/mK (PSX)						1,1		K/W
--	---------------	------------------------------------	--	--	--	--	--	-----	--	-----

#### PFC Shunt

##### Static

Resistance	$R$							5		mΩ
Tolerance							-1		1	%
Temperature coefficient	tc							110		ppm/K



Vincotech

### Characteristic Values

Parameter	Symbol	Conditions					Values			Unit
		$V_{GS}$ [V]	$V_{GE}$ [V]	$V_{DS}$ [V]	$V_{CE}$ [V]	$T_j$ [°C]	Min	Typ	Max	

#### Shunt

##### Static

Resistance	$R$							5		mΩ
Tolerance							-1		1	%
Temperature coefficient	tc							110		ppm/K

#### Capacitor (PFC)

##### Static

Capacitance	$C$	DC bias voltage = 0 V				25		33		nF
Tolerance							-5		5	%

#### Thermistor

##### Static

Rated resistance	$R$					25		22		kΩ
Deviation of R100	$\Delta_{R/R}$	$R_{100} = 1484 \Omega$				100	-5		5	%
Power dissipation	$P$					25		130		mW
Power dissipation constant	$d$					25		1,5		mW/K
B-value	$B_{(25/50)}$	Tol. $\pm 1 \%$						3962		K
B-value	$B_{(25/100)}$	Tol. $\pm 1 \%$						4000		K
Vincotech Thermistor Reference									I	

(2) Value at chip level

(3) Only valid with pre-applied Vincotech thermal interface material.



## Inverter Switch Characteristics

**figure 1.** IGBT

Typical output characteristics  
 $I_C = f(V_{CE})$

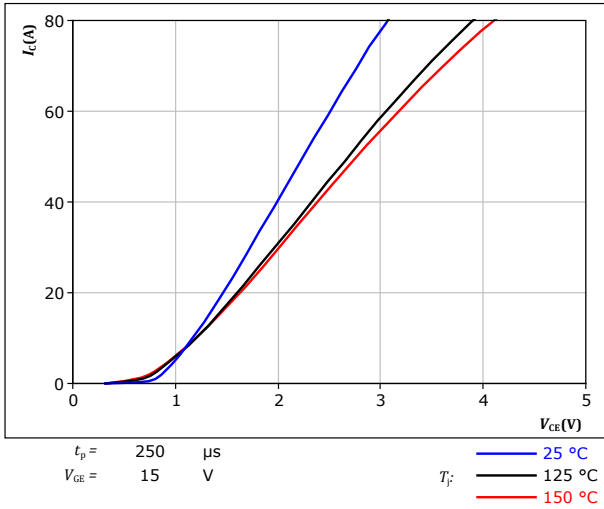

**figure 2.** IGBT

Typical output characteristics  
 $I_C = f(V_{CE})$

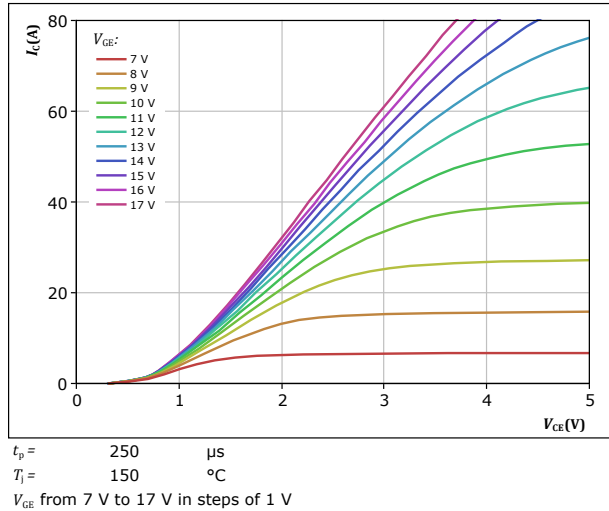

**figure 3.** IGBT

Typical transfer characteristics  
 $I_C = f(V_{GE})$

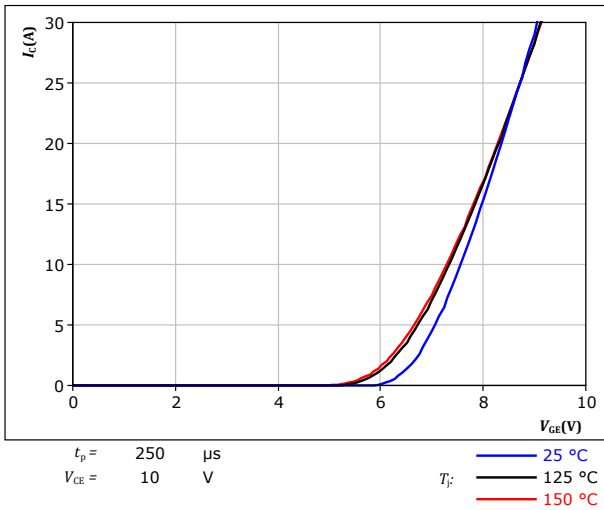

**figure 4.** IGBT

Short circuit withstand time as a function of  $V_{GE}$   
 $t_{sc} = f(V_{GE})$

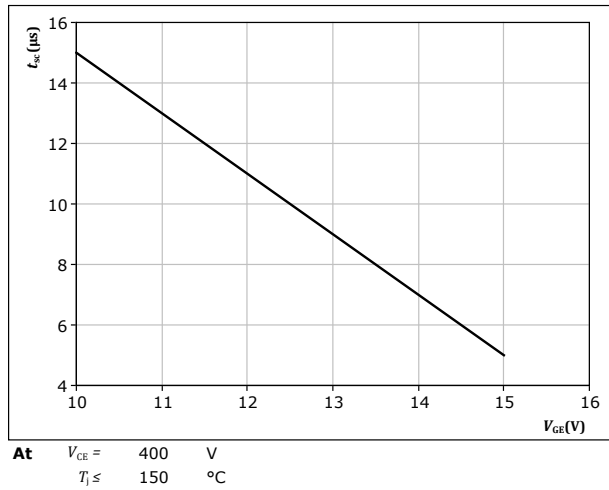



## Inverter Switch Characteristics

**figure 5.** IGBT

Typical short circuit current as a function of  $V_{GE}$   
 $I_{SC} = f(V_{GE})$

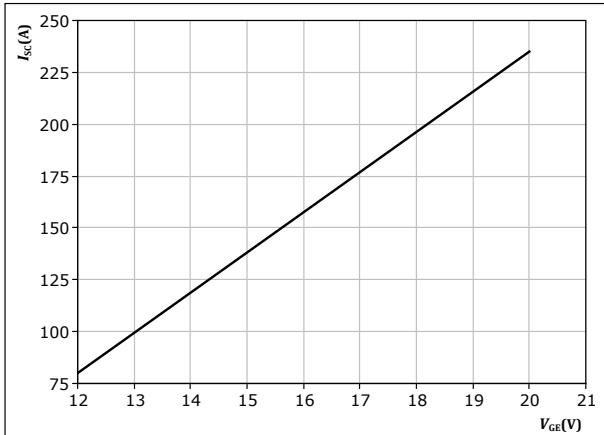

At  $V_{CE} = 400$  V  
 $T_j \leq 150$  °C

**figure 6.** IGBT

Transient thermal impedance as a function of pulse width  
 $Z_{th(j-s)} = f(t_p)$

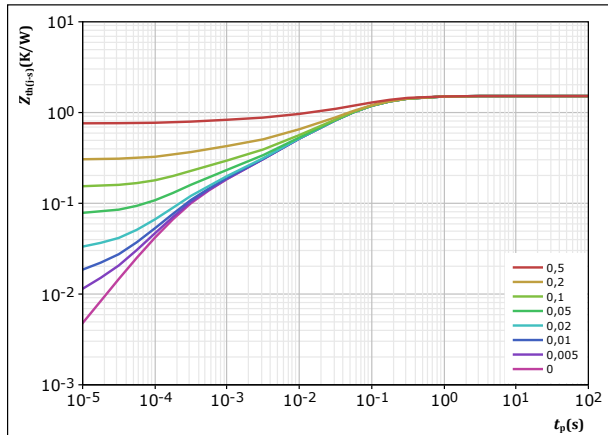

$D = t_p / T$   
 $R_{th(j-s)} = 1,52$  K/W  
IGBT thermal model values

$R$ (K/W)	$\tau$ (s)
1,77E-01	4,26E-01
6,88E-01	7,72E-02
3,07E-01	2,26E-02
2,02E-01	5,04E-03
6,94E-02	7,36E-04
7,56E-02	2,30E-04

**figure 7.** IGBT

Safe operating area  
 $I_C = f(V_{CE})$

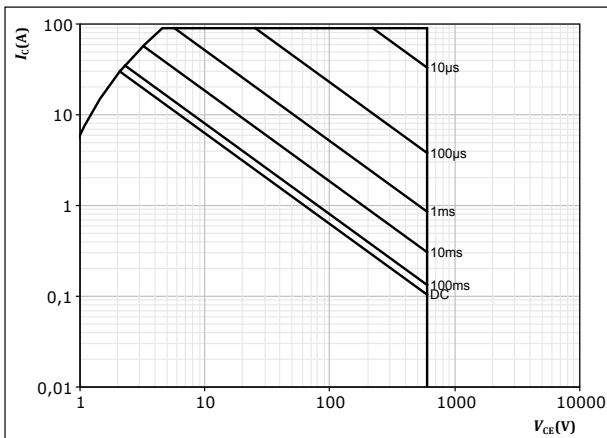

$D =$  single pulse  
 $T_j = 80$  °C  
 $V_{GE} = 15$  V  
 $T_j = T_{jmax}$

**figure 8.** IGBT

Gate voltage vs gate charge  
 $V_{GE} = f(Q_g)$

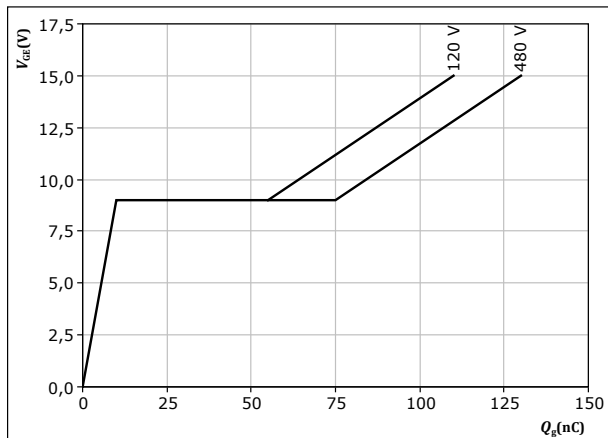

$I_C = 30$  A  
 $T_j = 25$  °C



## Inverter Diode Characteristics

figure 9. FWD

Typical forward characteristics

$$I_F = f(V_F)$$

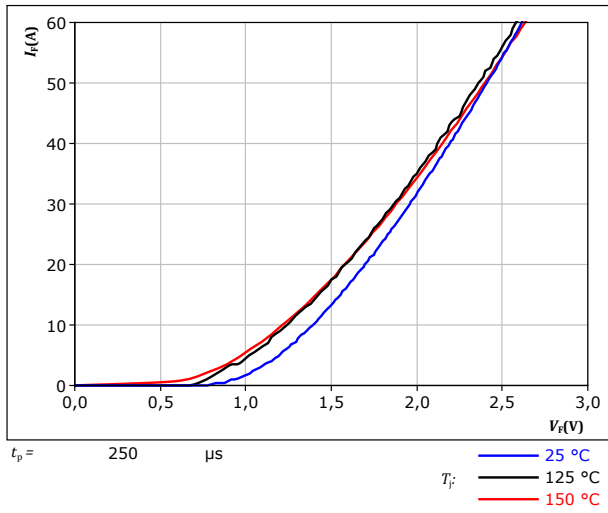
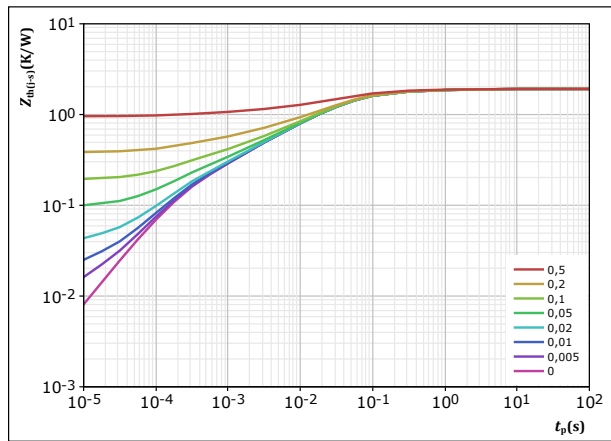

figure 10. FWD

Transient thermal impedance as a function of pulse width

$$Z_{th(j-s)} = f(t_p)$$



$D = \frac{t_p}{T}$   
 $R_{th(j-s)} = 1,914 \text{ K/W}$   
 FWD thermal model values

R (K/W)	$\tau$ (s)
8,07E-02	2,21E+00
2,18E-01	2,22E-01
8,50E-01	4,41E-02
4,32E-01	9,35E-03
2,00E-01	1,60E-03
1,34E-01	2,12E-04



### PFC Switch Characteristics

**figure 11.** IGBT

Typical output characteristics

$$I_C = f(V_{CE})$$

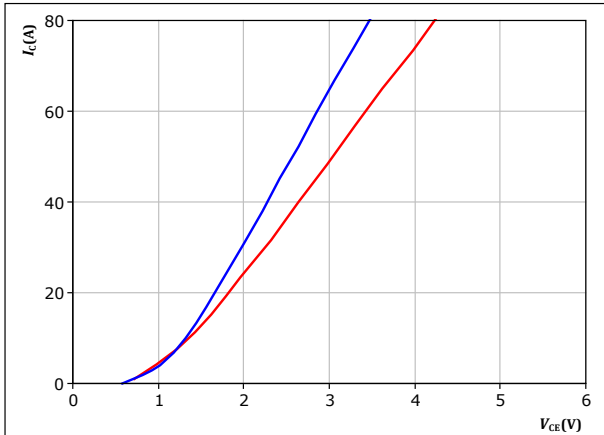

$t_p = 250 \mu s$   
 $V_{GE} = 15 V$   
 $T_j: 25^\circ C$  (blue line)  
 $125^\circ C$  (red line)

**figure 12.** IGBT

Typical output characteristics

$$I_C = f(V_{CE})$$

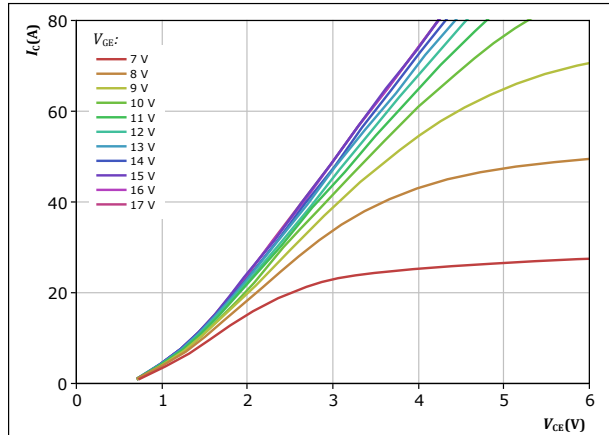

$t_p = 250 \mu s$   
 $T_j = 125^\circ C$   
 $V_{GE}$  from 7 V to 17 V in steps of 1 V

**figure 13.** IGBT

Typical transfer characteristics

$$I_C = f(V_{GE})$$

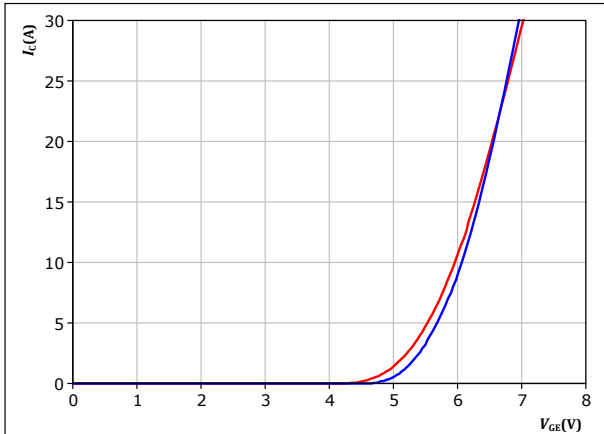

$t_p = 250 \mu s$   
 $V_{CE} = 10 V$   
 $T_j: 25^\circ C$  (blue line)  
 $125^\circ C$  (red line)

**figure 14.** IGBT

Transient thermal impedance as a function of pulse width

$$Z_{th(j-s)} = f(t_p)$$

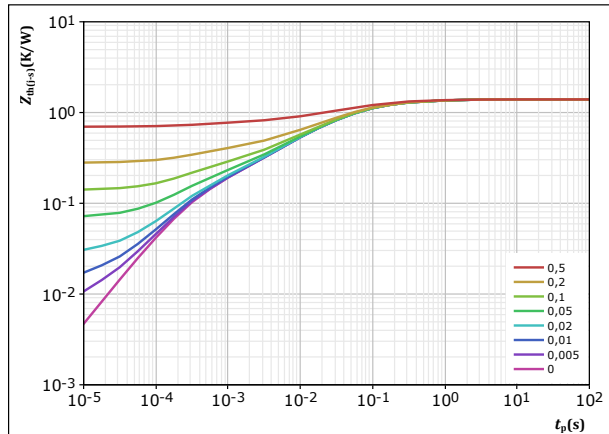

$D = t_p / T$   
 $R_{th(j-s)} = 1,394 K/W$   
IGBT thermal model values

R (K/W)	$\tau$ (s)
8,66E-02	1,03E+00
1,95E-01	1,93E-01
5,59E-01	5,17E-02
3,47E-01	9,99E-03
9,37E-02	1,86E-03
1,12E-01	2,95E-04



### PFC Switch Characteristics

figure 15. IGBT

Safe operating area

$$I_C = f(V_{CE})$$

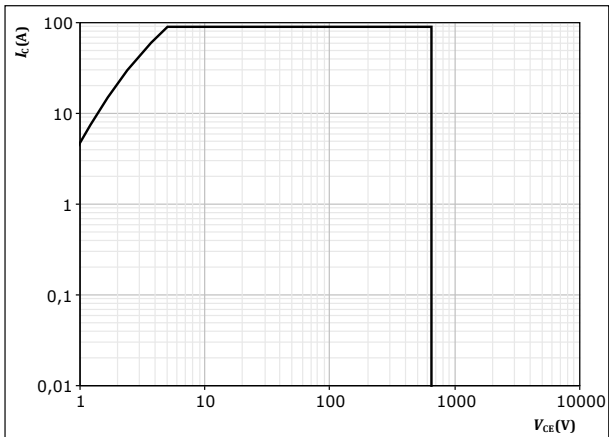

D = single pulse  
T<sub>s</sub> = 80 °C  
V<sub>GE</sub> = 15 V  
T<sub>j</sub> = T<sub>jmax</sub>

figure 16. IGBT

Gate voltage vs gate charge

$$V_{GE} = f(Q_g)$$

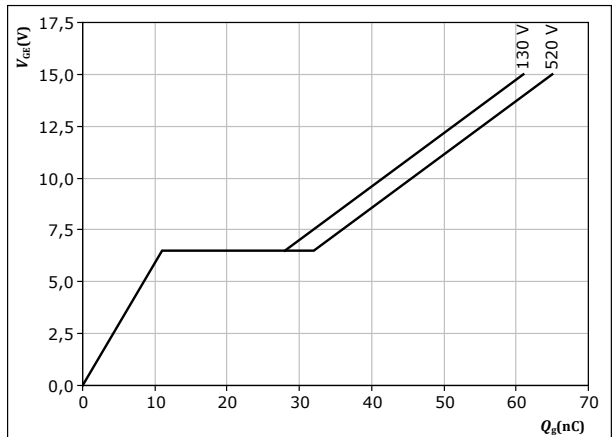

I<sub>C</sub> = 30 A  
T<sub>j</sub> = 25 °C



### PFC Diode Characteristics

figure 17. FWD

Typical forward characteristics

$$I_F = f(V_F)$$

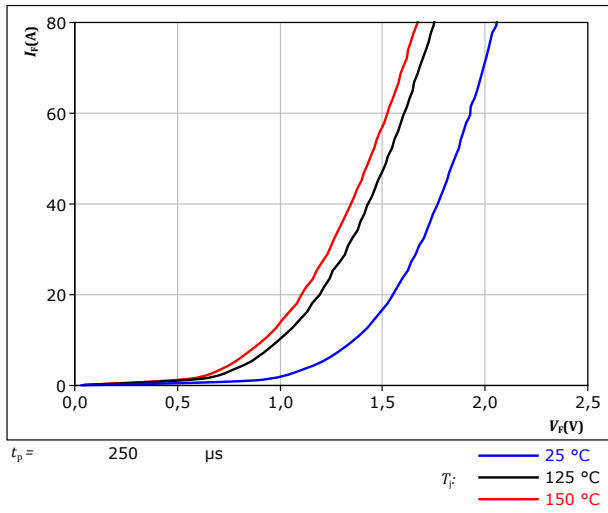
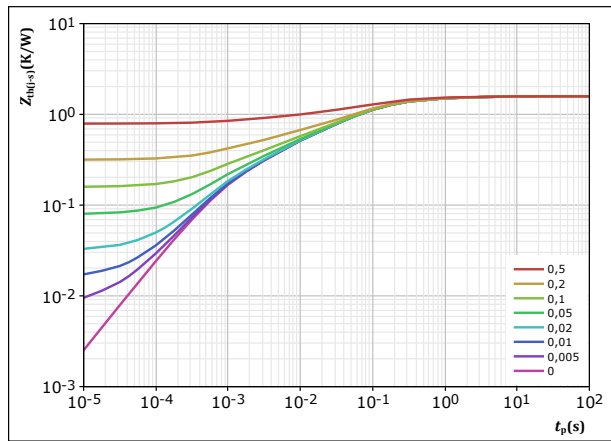

figure 18. FWD

Transient thermal impedance as a function of pulse width

$$Z_{th(j-s)} = f(t_p)$$



$D =$	$t_p / T$	
	1,581	K/W
FWD thermal model values		
$R$ (K/W)	$\tau$ (s)	
9,48E-02	2,80E+00	
2,89E-01	3,14E-01	
7,00E-01	6,69E-02	
3,27E-01	7,77E-03	
1,71E-01	8,57E-04	





## PFC Sw. Protection Diode Characteristics

figure 19. FWD

Typical forward characteristics

$$I_F = f(V_F)$$

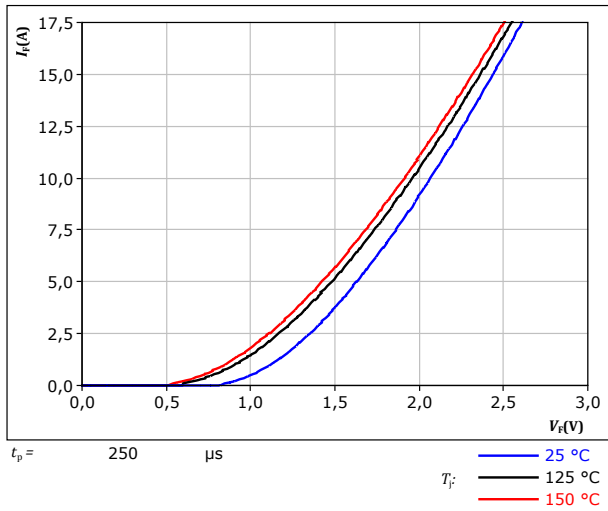
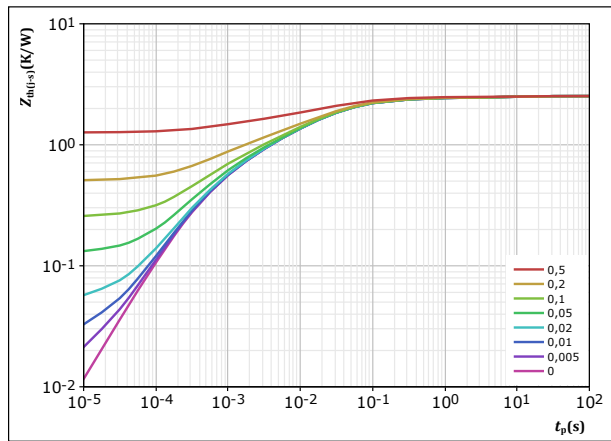

figure 20. FWD

Transient thermal impedance as a function of pulse width

$$Z_{th(j-s)} = f(t_p)$$



$D = \frac{t_p}{T}$   
 $R_{th(j-s)} = 2,527 \text{ K/W}$   
 FWD thermal model values

R (K/W)	$\tau$ (s)
9,24E-02	9,29E+00
1,75E-01	3,21E-01
7,31E-01	4,97E-02
7,14E-01	1,16E-02
4,89E-01	2,11E-03
3,27E-01	3,78E-04



## Rectifier Diode Characteristics

figure 21. Rectifier

Typical forward characteristics

$$I_F = f(V_F)$$

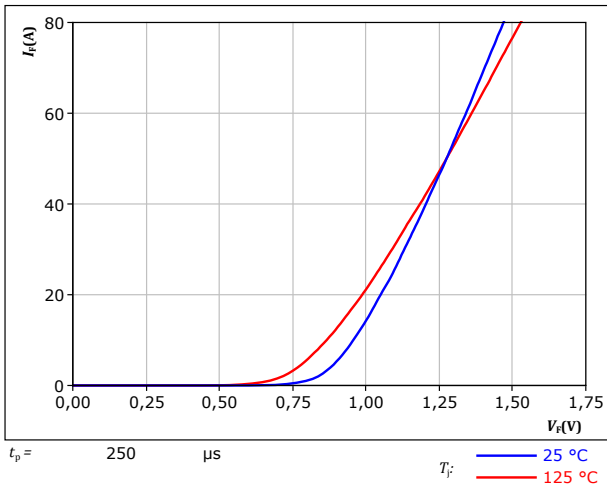
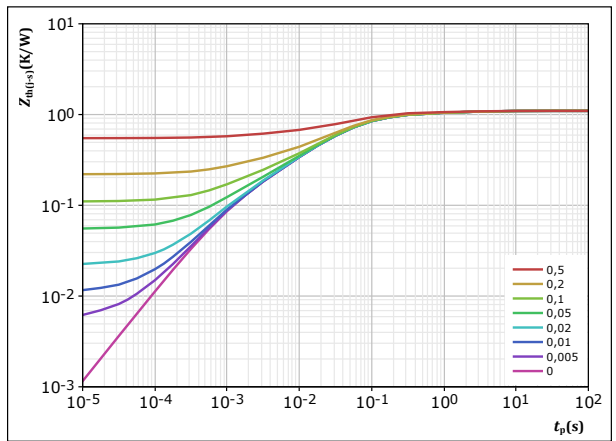

figure 22. Rectifier

Transient thermal impedance as a function of pulse width

$$Z_{th(j-s)} = f(t_p)$$



$D = t_p / T$   
 $R_{th(j-s)} = 1,098$  K/W  
 Rectifier thermal model values

$R$ (K/W)	$\tau$ (s)
4,35E-02	3,78E+00
9,34E-02	6,17E-01
3,79E-01	8,75E-02
3,82E-01	2,72E-02
1,24E-01	5,56E-03
7,66E-02	1,02E-03



## Thermistor Characteristics

figure 23. Thermistor

Typical NTC characteristic as function of temperature

$$R_T = f(T)$$

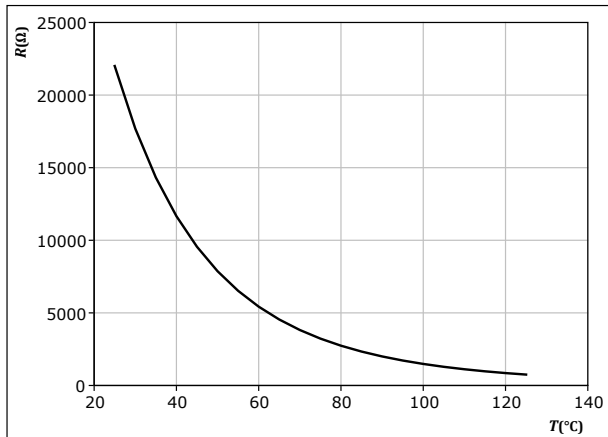



## Inverter Switching Characteristics

**figure 24.** IGBT

Typical switching energy losses as a function of collector current  
 $E = f(I_c)$

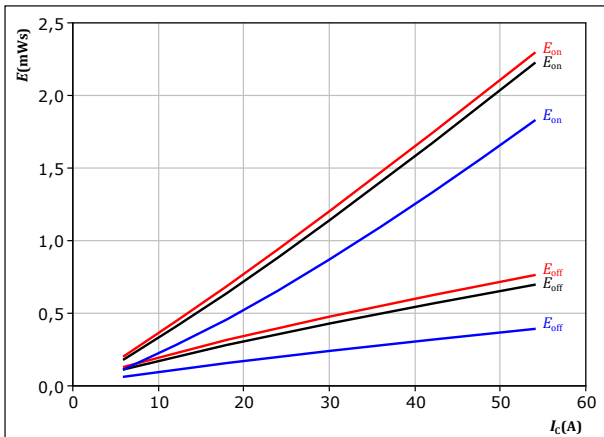

With an inductive load at

$V_{CE} =$	350	V	$T_j:$	— 25 °C
$V_{GE} =$	±15	V		— 125 °C
$R_{gon} =$	8	Ω		— 150 °C
$R_{goff} =$	8	Ω		

**figure 25.** IGBT

Typical switching energy losses as a function of IGBT turn on gate resistor  
 $E = f(R_g)$

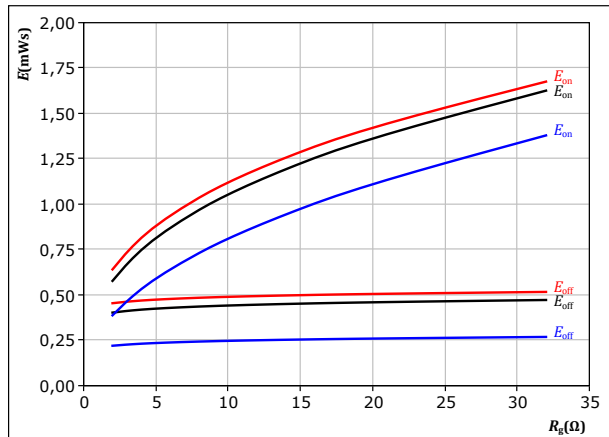

With an inductive load at

$V_{CE} =$	350	V	$T_j:$	— 25 °C
$V_{GE} =$	±15	V		— 125 °C
$I_c =$	30	A		— 150 °C

**figure 26.** FWD

Typical reverse recovered energy loss as a function of collector current  
 $E_{rec} = f(I_c)$

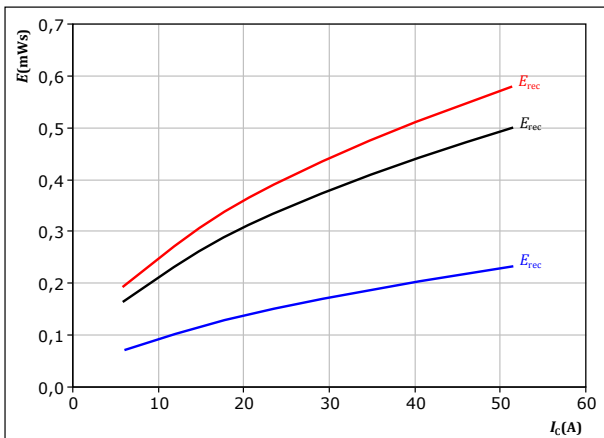

With an inductive load at

$V_{CE} =$	350	V	$T_j:$	— 25 °C
$V_{GE} =$	±15	V		— 125 °C
$R_{gon} =$	8	Ω		— 150 °C

**figure 27.** FWD

Typical reverse recovered energy loss as a function of IGBT turn on gate resistor  
 $E_{rec} = f(R_g)$

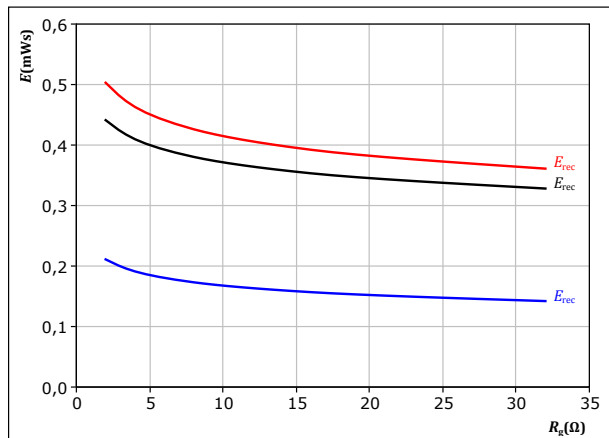

With an inductive load at

$V_{CE} =$	350	V	$T_j:$	— 25 °C
$V_{GE} =$	±15	V		— 125 °C
$I_c =$	30	A		— 150 °C



## Inverter Switching Characteristics

**figure 28.** IGBT

Typical switching times as a function of collector current  
 $t = f(I_c)$

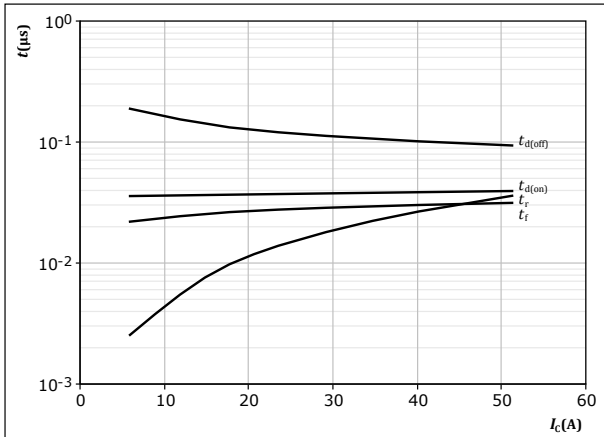

With an inductive load at  
 $T_j = 150 \text{ } ^\circ\text{C}$   
 $V_{CE} = 350 \text{ V}$   
 $V_{GE} = \pm 15 \text{ V}$   
 $R_{gon} = 8 \text{ } \Omega$   
 $R_{goff} = 8 \text{ } \Omega$

**figure 29.** IGBT

Typical switching times as a function of IGBT turn on gate resistor  
 $t = f(R_g)$

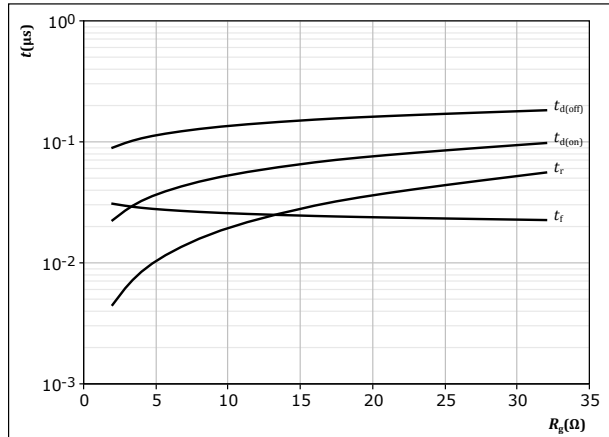

With an inductive load at  
 $T_j = 150 \text{ } ^\circ\text{C}$   
 $V_{CE} = 350 \text{ V}$   
 $V_{GE} = \pm 15 \text{ V}$   
 $I_c = 30 \text{ A}$

**figure 30.** FWD

Typical reverse recovery time as a function of collector current  
 $t_{rr} = f(I_c)$

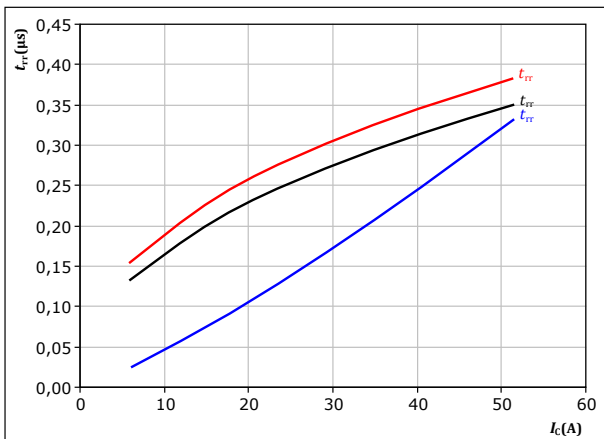

With an inductive load at  
 $V_{CE} = 350 \text{ V}$   
 $V_{GE} = \pm 15 \text{ V}$   
 $R_{gon} = 8 \text{ } \Omega$

$T_j$ : — 25 °C  
 — 125 °C  
 — 150 °C

**figure 31.** FWD

Typical reverse recovery time as a function of IGBT turn on gate resistor  
 $t_{rr} = f(R_{gon})$

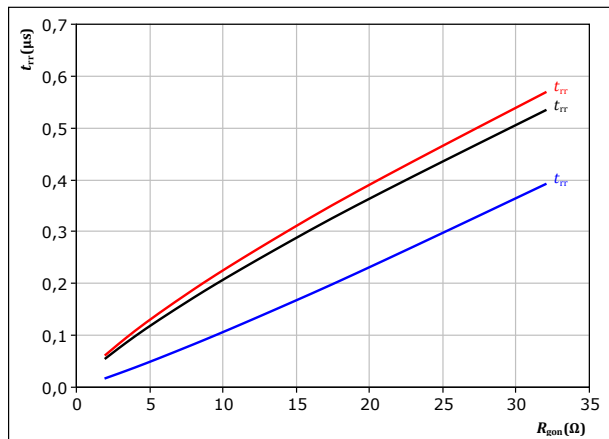

With an inductive load at  
 $V_{CE} = 350 \text{ V}$   
 $V_{GE} = \pm 15 \text{ V}$   
 $I_c = 30 \text{ A}$

$T_j$ : — 25 °C  
 — 125 °C  
 — 150 °C



## Inverter Switching Characteristics

figure 32. FWD

Typical recovered charge as a function of collector current

$$Q_r = f(I_c)$$

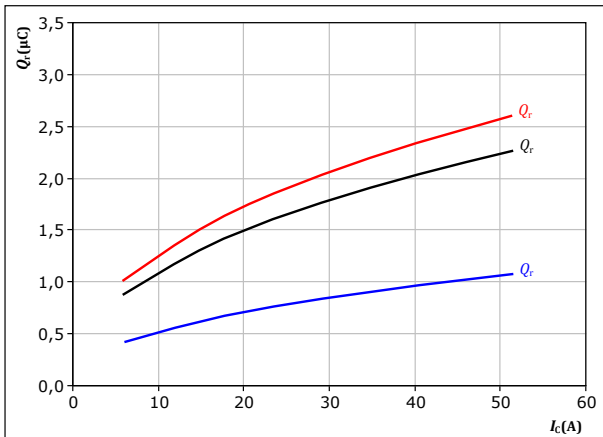

With an inductive load at

$V_{CE} = 350 \text{ V}$   
 $V_{GE} = \pm 15 \text{ V}$   
 $R_{gon} = 8 \ \Omega$

$T_j$ : 25 °C (blue)  
 125 °C (black)  
 150 °C (red)

figure 33. FWD

Typical recovered charge as a function of IGBT turn on gate resistor

$$Q_r = f(R_{gon})$$

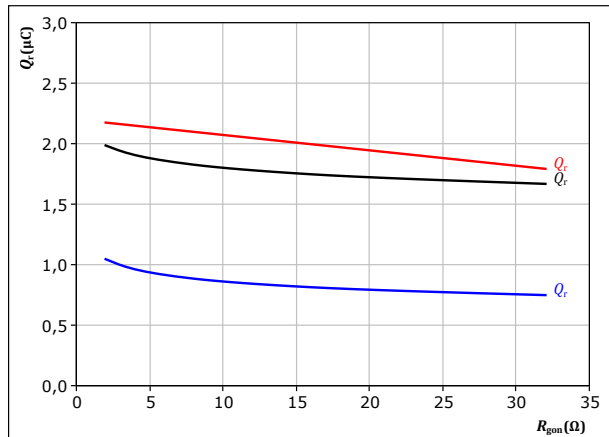

With an inductive load at

$V_{CE} = 350 \text{ V}$   
 $V_{GE} = \pm 15 \text{ V}$   
 $I_c = 30 \text{ A}$

$T_j$ : 25 °C (blue)  
 125 °C (black)  
 150 °C (red)

figure 34. FWD

Typical peak reverse recovery current as a function of collector current

$$I_{RM} = f(I_c)$$

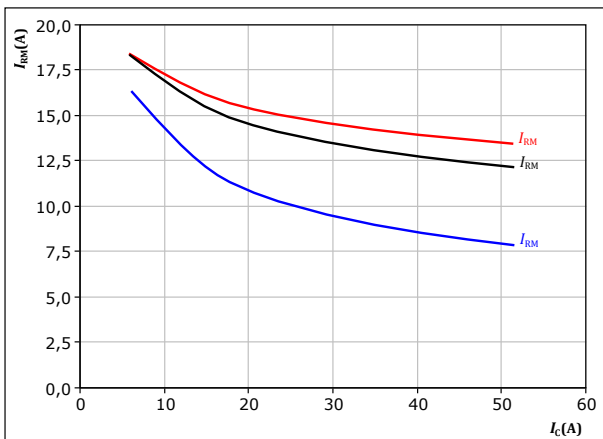

With an inductive load at

$V_{CE} = 350 \text{ V}$   
 $V_{GE} = \pm 15 \text{ V}$   
 $R_{gon} = 8 \ \Omega$

$T_j$ : 25 °C (blue)  
 125 °C (black)  
 150 °C (red)

figure 35. FWD

Typical peak reverse recovery current as a function of IGBT turn on gate resistor

$$I_{RM} = f(R_{gon})$$

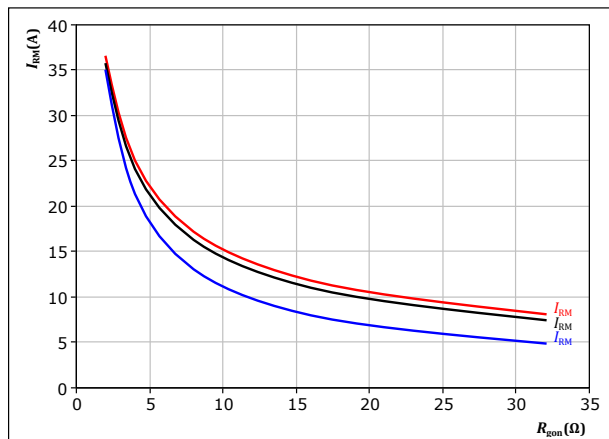

With an inductive load at

$V_{CE} = 350 \text{ V}$   
 $V_{GE} = \pm 15 \text{ V}$   
 $I_c = 30 \text{ A}$

$T_j$ : 25 °C (blue)  
 125 °C (black)  
 150 °C (red)



## Inverter Switching Characteristics

**figure 36.** FWD

Typical rate of fall of forward and reverse recovery current as a function of collector current  
 $di_f/dt, di_{rr}/dt = f(I_c)$

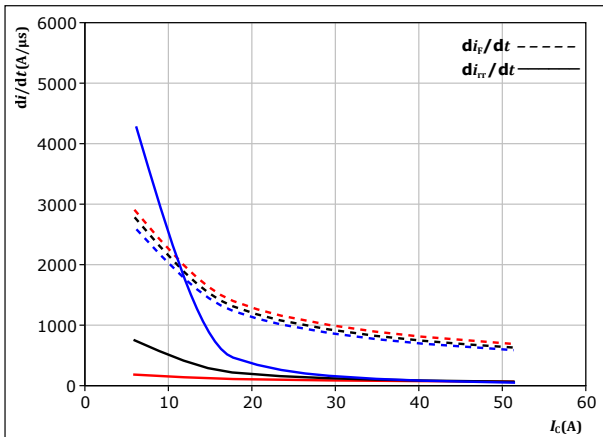

With an inductive load at

$V_{CE} =$	350	V	$T_j =$	25 °C
$V_{GE} =$	±15	V		125 °C
$R_{gon} =$	8	Ω		150 °C

**figure 37.** FWD

Typical rate of fall of forward and reverse recovery current as a function of turn on gate resistor  
 $di_f/dt, di_{rr}/dt = f(R_{gon})$

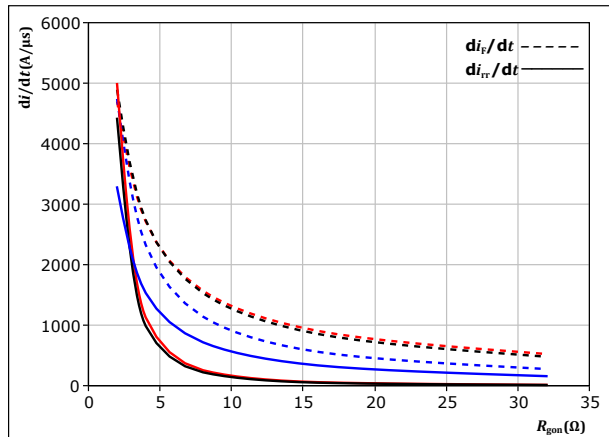

With an inductive load at

$V_{CE} =$	350	V	$T_j =$	25 °C
$V_{GE} =$	±15	V		125 °C
$I_c =$	30	A		150 °C

**figure 38.** IGBT

Reverse bias safe operating area

$I_c = f(V_{CE})$

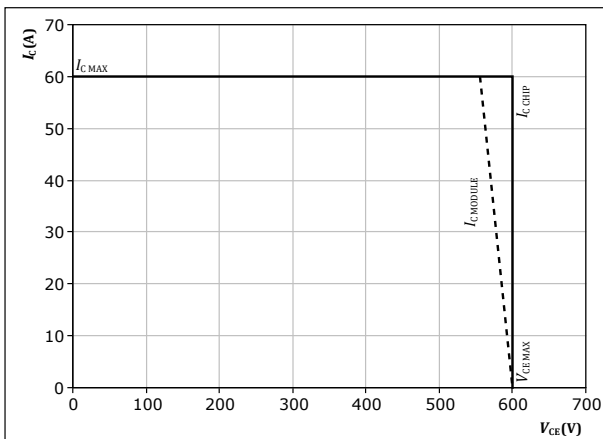

At  $T_j = 150$  °C  
 $R_{gon} = 8$  Ω  
 $R_{goff} = 8$  Ω



## PFC Switching Characteristics

**figure 39.** IGBT

Typical switching energy losses as a function of collector current  
 $E = f(I_c)$

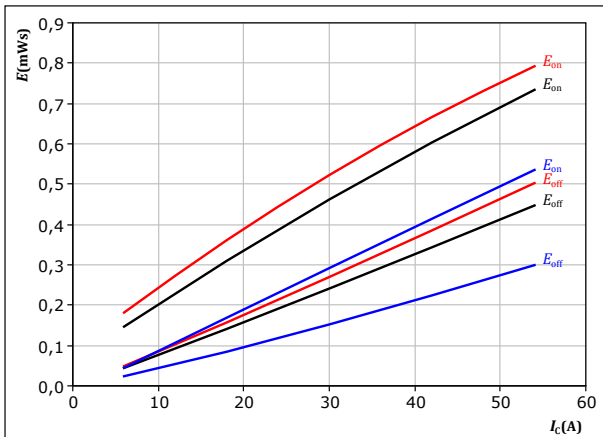

With an inductive load at  
 $V_{CE} = 400$  V  
 $V_{GE} = 0/15$  V  
 $R_{gon} = 8$   $\Omega$   
 $R_{goff} = 8$   $\Omega$

$T_j$ : — 25 °C  
 — 125 °C  
 — 150 °C

**figure 40.** IGBT

Typical switching energy losses as a function of IGBT turn on gate resistor  
 $E = f(R_g)$

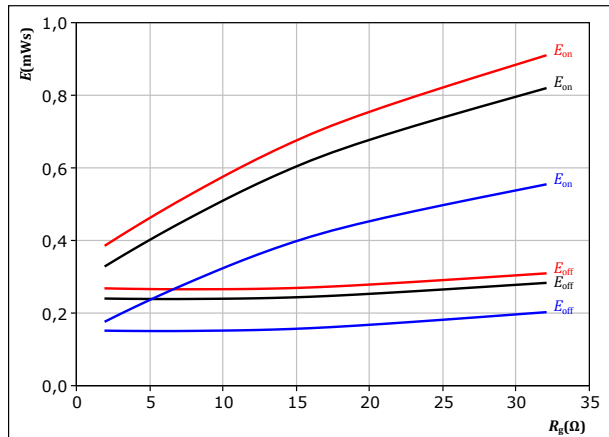

With an inductive load at  
 $V_{CE} = 400$  V  
 $V_{GE} = 0/15$  V  
 $I_c = 30$  A

$T_j$ : — 25 °C  
 — 125 °C  
 — 150 °C

**figure 41.** FWD

Typical reverse recovered energy loss as a function of collector current  
 $E_{rec} = f(I_c)$

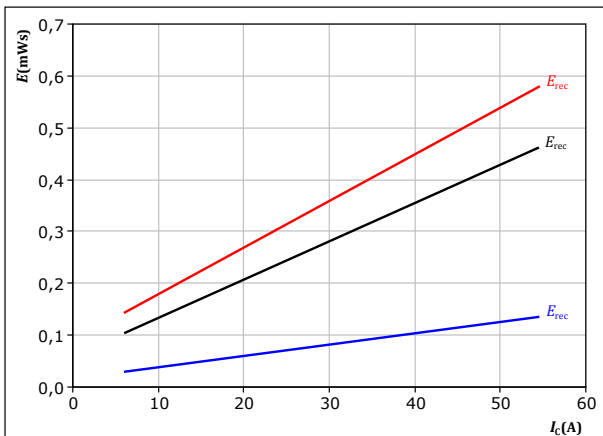

With an inductive load at  
 $V_{CE} = 400$  V  
 $V_{GE} = 0/15$  V  
 $R_{gon} = 8$   $\Omega$

$T_j$ : — 25 °C  
 — 125 °C  
 — 150 °C

**figure 42.** FWD

Typical reverse recovered energy loss as a function of IGBT turn on gate resistor  
 $E_{rec} = f(R_g)$

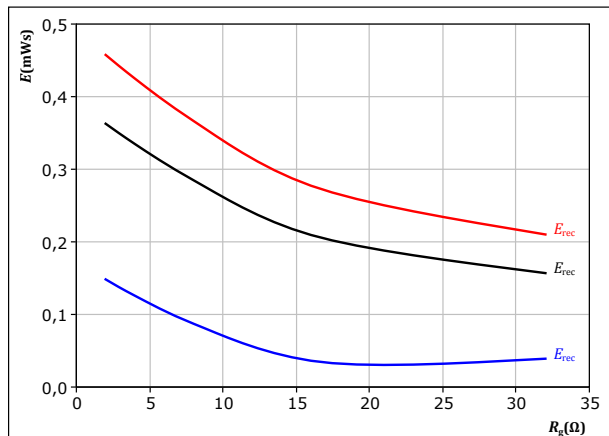

With an inductive load at  
 $V_{CE} = 400$  V  
 $V_{GE} = 0/15$  V  
 $I_c = 30$  A

$T_j$ : — 25 °C  
 — 125 °C  
 — 150 °C





## PFC Switching Characteristics

**figure 43.** IGBT

Typical switching times as a function of collector current  
 $t = f(I_c)$

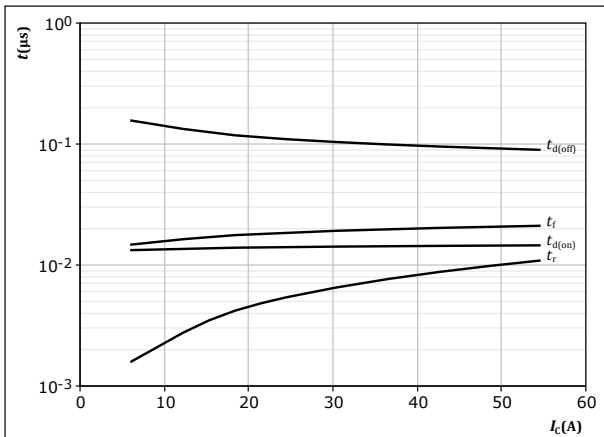

With an inductive load at  
 $T_j = 150$  °C  
 $V_{CE} = 400$  V  
 $V_{GE} = 0/15$  V  
 $R_{gon} = 8$  Ω  
 $R_{goff} = 8$  Ω

**figure 44.** IGBT

Typical switching times as a function of IGBT turn on gate resistor  
 $t = f(R_g)$

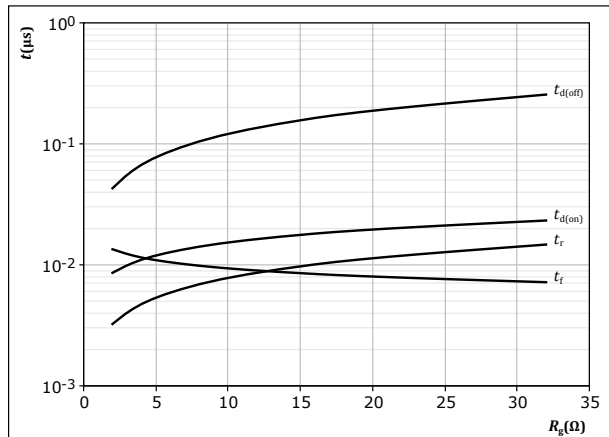

With an inductive load at  
 $T_j = 150$  °C  
 $V_{CE} = 400$  V  
 $V_{GE} = 0/15$  V  
 $I_c = 30$  A

**figure 45.** FWD

Typical reverse recovery time as a function of collector current  
 $t_{rr} = f(I_c)$

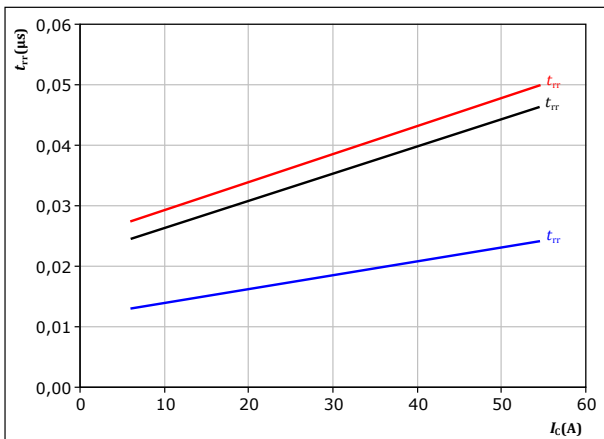

With an inductive load at  
 $V_{CE} = 400$  V  
 $V_{GE} = 0/15$  V  
 $R_{gon} = 8$  Ω  
 $T_j:$  — 25 °C  
— 125 °C  
— 150 °C

**figure 46.** FWD

Typical reverse recovery time as a function of IGBT turn on gate resistor  
 $t_{rr} = f(R_{gon})$

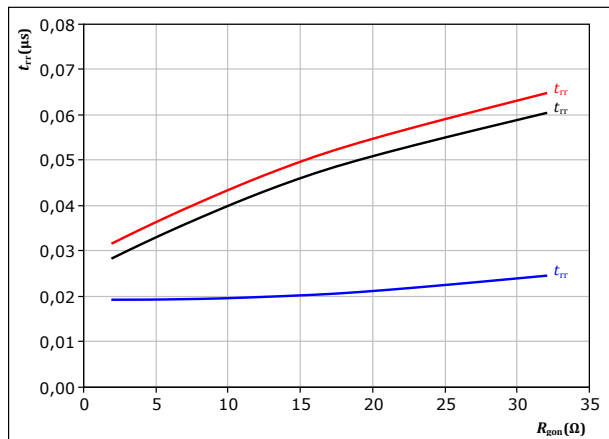

With an inductive load at  
 $V_{CE} = 400$  V  
 $V_{GE} = 0/15$  V  
 $I_c = 30$  A  
 $T_j:$  — 25 °C  
— 125 °C  
— 150 °C



## PFC Switching Characteristics

**figure 47.** FWD

Typical recovered charge as a function of collector current

$$Q_r = f(I_c)$$

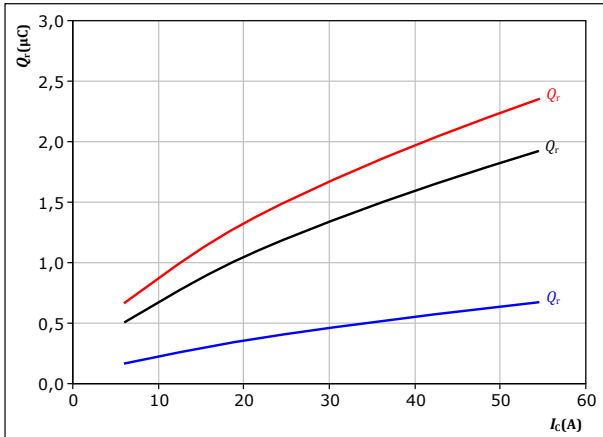

With an inductive load at

$V_{CE} = 400$  V  
 $V_{GE} = 0/15$  V  
 $R_{gon} = 8$  Ω

$T_j$ : — 25 °C  
— 125 °C  
— 150 °C

**figure 48.** FWD

Typical recovered charge as a function of IGBT turn on gate resistor

$$Q_r = f(R_{gon})$$

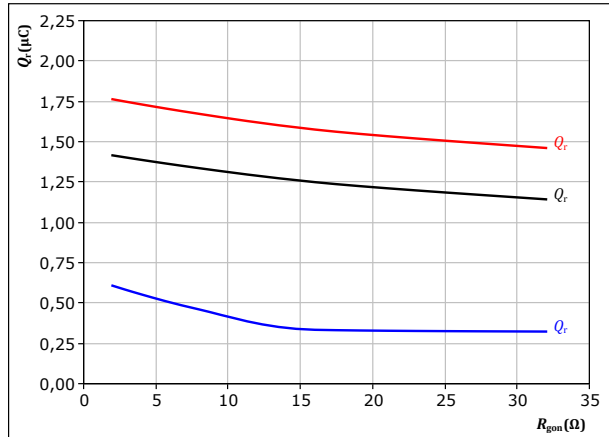

With an inductive load at

$V_{CE} = 400$  V  
 $V_{GE} = 0/15$  V  
 $I_c = 30$  A

$T_j$ : — 25 °C  
— 125 °C  
— 150 °C

**figure 49.** FWD

Typical peak reverse recovery current as a function of collector current

$$I_{RM} = f(I_c)$$

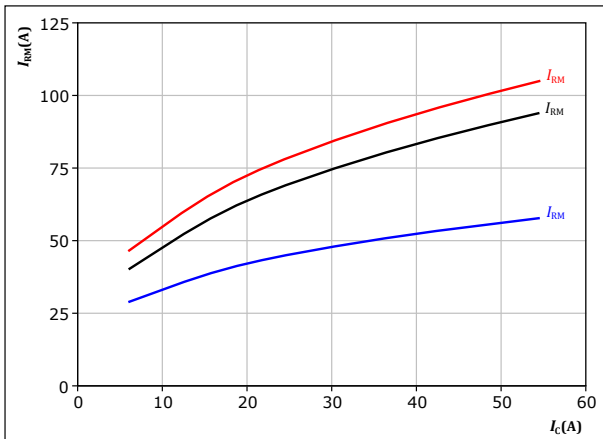

With an inductive load at

$V_{CE} = 400$  V  
 $V_{GE} = 0/15$  V  
 $R_{gon} = 8$  Ω

$T_j$ : — 25 °C  
— 125 °C  
— 150 °C

**figure 50.** FWD

Typical peak reverse recovery current as a function of IGBT turn on gate resistor

$$I_{RM} = f(R_{gon})$$

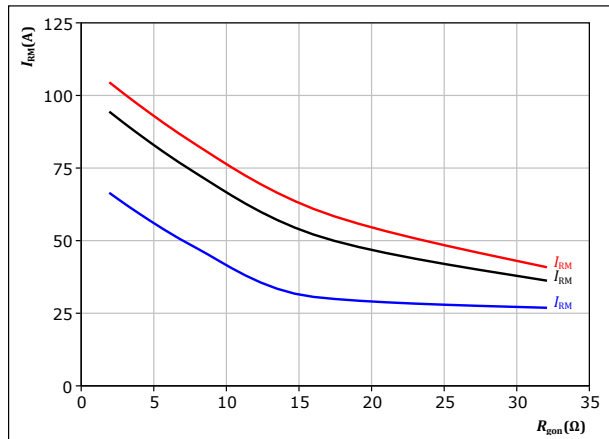

With an inductive load at

$V_{CE} = 400$  V  
 $V_{GE} = 0/15$  V  
 $I_c = 30$  A

$T_j$ : — 25 °C  
— 125 °C  
— 150 °C



## PFC Switching Characteristics

**figure 51.** FWD

Typical rate of fall of forward and reverse recovery current as a function of collector current  
 $di_i/dt, di_r/dt = f(I_c)$

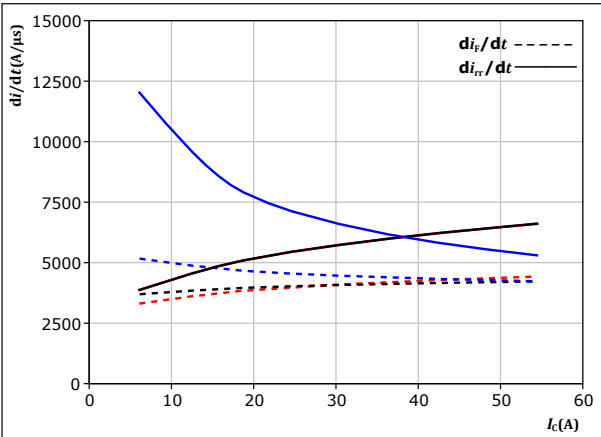

With an inductive load at

$V_{CE} = 400$  V  
 $V_{GE} = 0/15$  V  
 $R_{gon} = 8$   $\Omega$

$T_j$ : — 25 °C  
 — 125 °C  
 — 150 °C

**figure 52.** FWD

Typical rate of fall of forward and reverse recovery current as a function of turn on gate resistor  
 $di_i/dt, di_r/dt = f(R_{gon})$

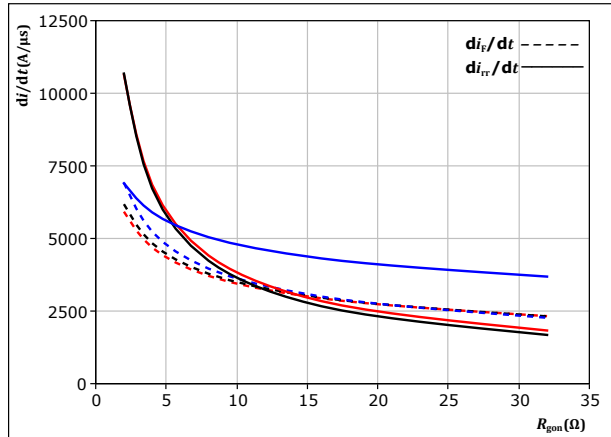

With an inductive load at

$V_{CE} = 400$  V  
 $V_{GE} = 0/15$  V  
 $I_c = 30$  A

$T_j$ : — 25 °C  
 — 125 °C  
 — 150 °C

**figure 53.** IGBT

Reverse bias safe operating area

$I_c = f(V_{CE})$

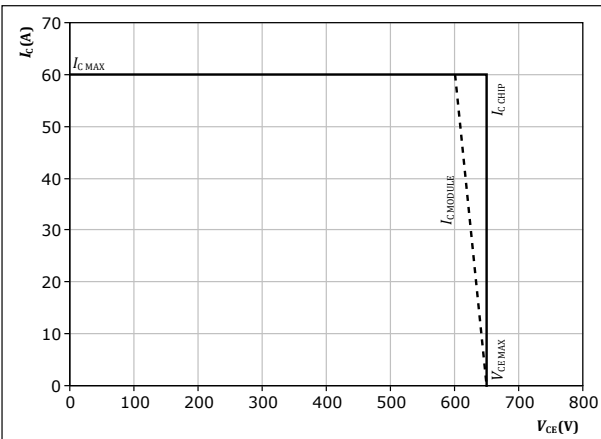

At  $T_j = 150$  °C  
 $R_{gon} = 8$   $\Omega$   
 $R_{goff} = 8$   $\Omega$



## Switching Definitions

figure 54. IGBT

Turn-off Switching Waveforms & definition of  $t_{doff}$ ,  $t_{Eoff}$  ( $t_{Eoff}$  = integrating time for  $E_{off}$ )

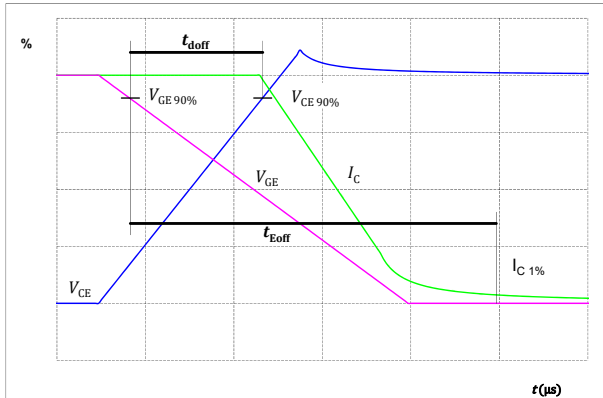

figure 55. IGBT

Turn-on Switching Waveforms & definition of  $t_{don}$ ,  $t_{Eon}$  ( $t_{Eon}$  = integrating time for  $E_{on}$ )

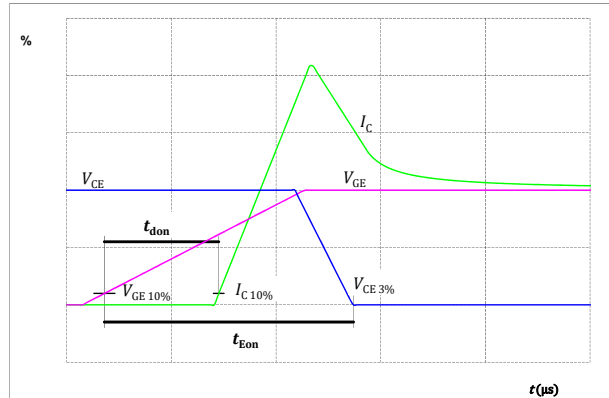

figure 56. IGBT

Turn-off Switching Waveforms & definition of  $t_f$

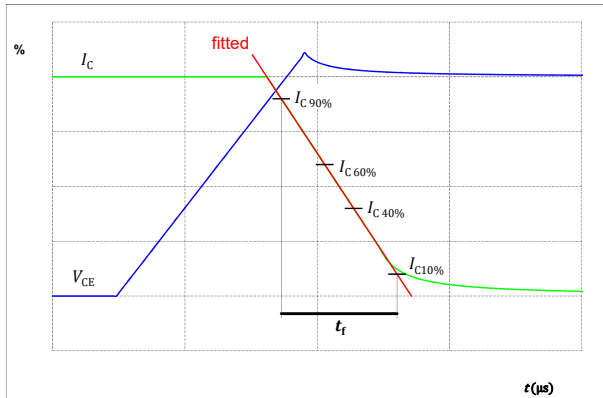
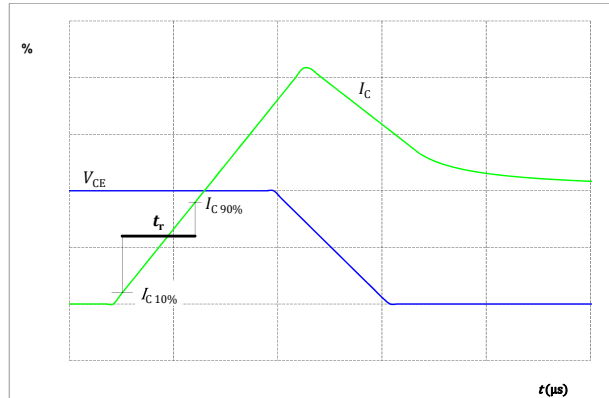

figure 57. IGBT

Turn-on Switching Waveforms & definition of  $t_r$





## Switching Definitions

figure 58. FWD

Turn-off Switching Waveforms & definition of  $t_{rr}$

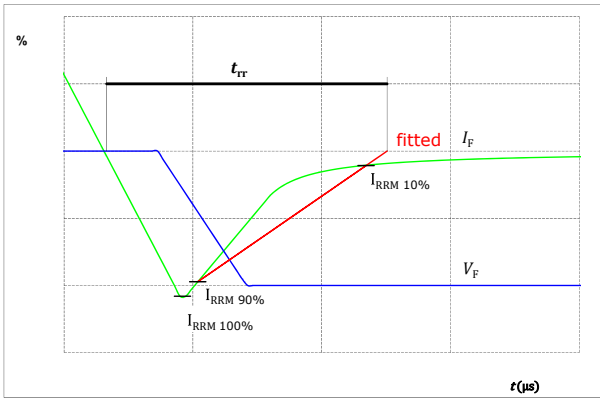
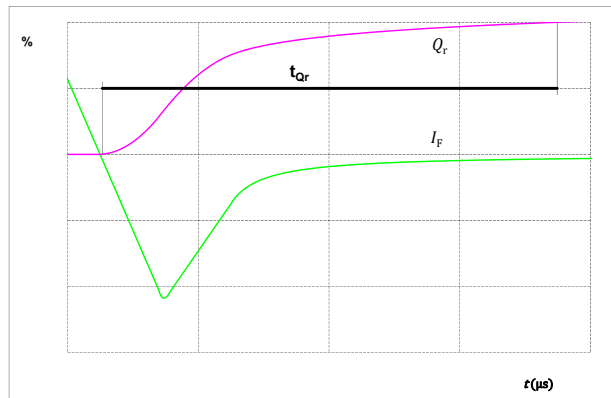

figure 59. FWD

Turn-on Switching Waveforms & definition of  $t_{Qr}$  ( $t_{Qr}$  = integrating time for  $Q_r$ )





Vincotech

Ordering Code	
<b>Version</b>	<b>Ordering Code</b>
Without thermal paste	10-PG06PPA030SJ04-LJ02B03T
With thermal paste (5,2 W/mK, PTM6000HV)	10-PG06PPA030SJ04-LJ02B03T-/7/
With thermal paste (3,4 W/mK, PSX-P7)	10-PG06PPA030SJ04-LJ02B03T-/3/

Marking						
	<b>Text</b>	<b>Name</b> NN-NNNNNNNNNNNNNN- TTTTIV	<b>Date code</b> WWYY	<b>UL &amp; VIN</b> UL VIN	<b>Lot</b> LLLLL	<b>Serial</b> SSSS
	<b>Datamatrix</b>	<b>Type&amp;Ver</b> TTTTIV	<b>Lot number</b> LLLLL	<b>Serial</b> SSSS	<b>Date code</b> WWYY	

Outline			
Pin table [mm]			
Pin	X	Y	Function
1	50,5	7,4	S2sh1
2	49,5	4,4	S1sh1
3	45,5	0	DC-Rect
4	42,8	0	DC-Rect
5	38,5	0	PFC-
6	38,5	3	S1sh2
7	38,5	6	S2sh2
8	31,8	1,2	PFC+
9	31,8	3,9	PFC+
10	25,1	1,9	S1sh3
11	23,1	4,9	S2sh3
12	22,1	0	PFC-
13	19,1	0	Therm1
14	19,1	3	Therm2
15	15	0	G11
16	12	0	DC-1
17	9	0	G13
18	6	0	DC-2
19	3	0	G15
20	0	0	DC-3
21	0	15,15	DC+Inv
22	0	17,85	DC+Inv
23	0	25,5	G16
24	0	28,5	Ph3
25	7,7	25,5	G14
26	7,7	28,5	Ph2
27	15,4	25,5	G12
28	15,4	28,5	Ph1
29	21,7	16,3	G27
30	21,7	19,3	S27
31	23,4	28,5	PFC2
32	31,1	28,5	PFC1
33	32,9	19,3	G25
34	35,9	19,3	S25
35	39,1	28,5	DC+Rect
36	41,8	28,5	DC+Rect
37	49,8	28,5	ACIn1
38	52,5	28,5	ACIn1
39	44,3	17,2	ACIn2
40	44,3	14,45	ACIn2

center of gross-fit pinhead  
for connection parameter see the handling instruction

10,25 ±0,1  
16,4 ±0,05

14,25  
26,25

Tolerance of pinpositions: ±0.4mm of the end of pins  
Dimension of coordinate axis is only offset without tolerance



Vincotech

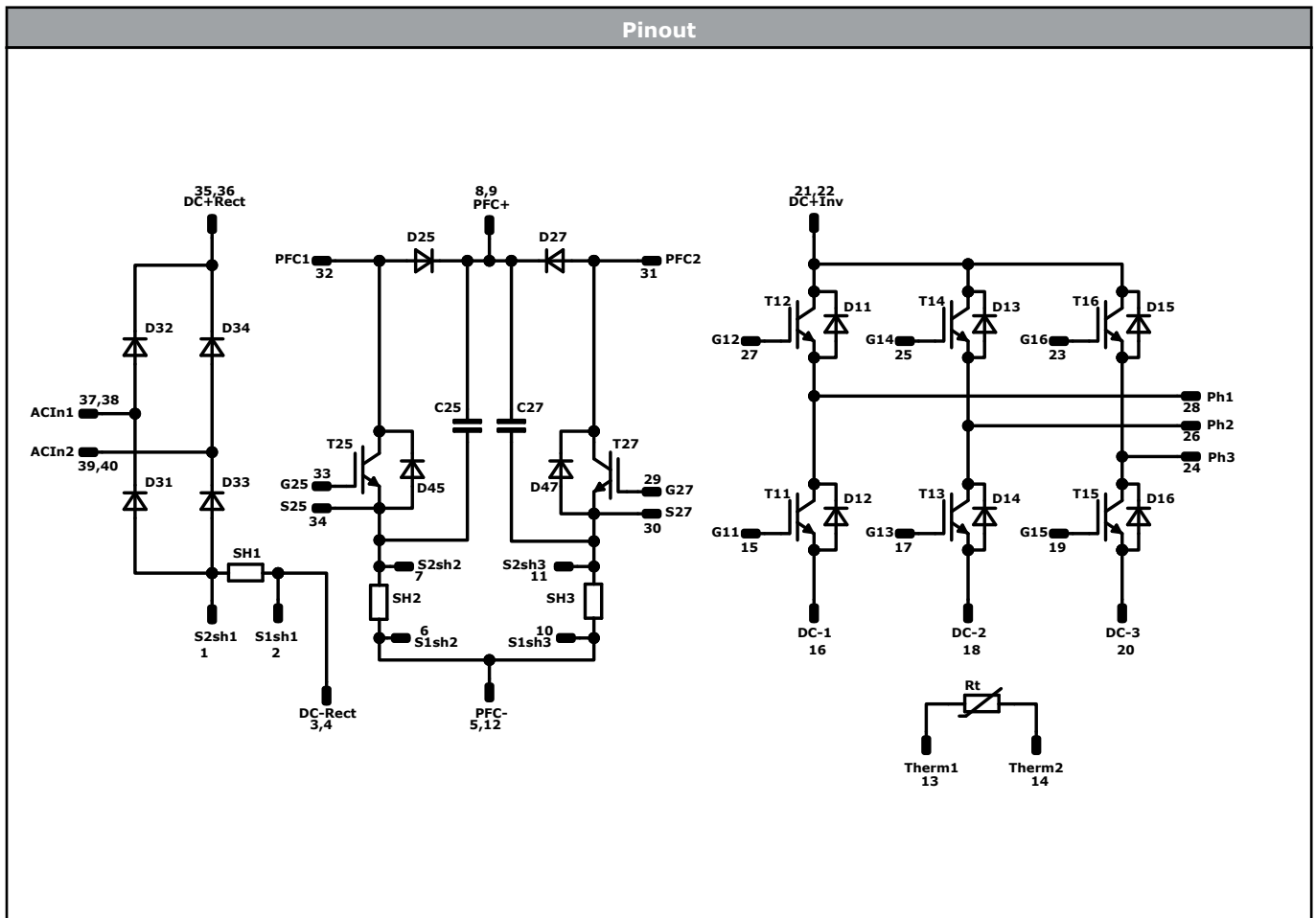

Identification					
ID	Component	Voltage	Current	Function	Comment
T11, T12, T13, T14, T15, T16	IGBT	600 V	30 A	Inverter Switch	
D11, D12, D13, D14, D15, D16	FWD	600 V	20 A	Inverter Diode	
T25, T27	IGBT	650 V	30 A	PFC Switch	
D25, D27	FWD	600 V	30 A	PFC Diode	
D45, D47	FWD	650 V	6 A	PFC Sw. Protection Diode	
D31, D32, D33, D34	Rectifier	1600 V	31 A	Rectifier Diode	
SH1	Shunt			PFC Shunt	
SH2, SH3	Shunt			Shunt	
C25, C27	Capacitor	630 V		Capacitor (PFC)	
Rt	Thermistor			Thermistor	



Vincotech

Packaging instruction				
Standard packaging quantity (SPQ) 100	>SPQ	Standard	<SPQ	Sample

Handling instruction
Handling instructions for <i>flow 1</i> packages see vincotech.com website.

Package data
Package data for <i>flow 1</i> packages see vincotech.com website.

Vincotech thermistor reference
See Vincotech thermistor reference table at vincotech.com website.

UL recognition and file number
This device is certified according to UL 1557 standard, UL file number E192116. For more information see vincotech.com website. 

Document No.:	Date:	Modification:	Pages
10-PG06PPA030SJ04-LJ02B03T-D2-14	8 Jun. 2023	PFC Diode change	

**DISCLAIMER**

The information, specifications, procedures, methods and recommendations herein (together "information") are presented by Vincotech to reader in good faith, are believed to be accurate and reliable, but may well be incomplete and/or not applicable to all conditions or situations that may exist or occur. Vincotech reserves the right to make any changes without further notice to any products to improve reliability, function or design. No representation, guarantee or warranty is made to reader as to the accuracy, reliability or completeness of said information or that the application or use of any of the same will avoid hazards, accidents, losses, damages or injury of any kind to persons or property or that the same will not infringe third parties rights or give desired results. It is reader's sole responsibility to test and determine the suitability of the information and the product for reader's intended use.

**LIFE SUPPORT POLICY**

Vincotech products are not authorised for use as critical components in life support devices or systems without the express written approval of Vincotech.

As used herein:

1. Life support devices or systems are devices or systems which, (a) are intended for surgical implant into the body, or (b) support or sustain life, or (c) whose failure to perform when properly used in accordance with instructions for use provided in labelling can be reasonably expected to result in significant injury to the user.
2. A critical component is any component of a life support device or system whose failure to perform can be reasonably expected to cause the failure of the life support device or system, or to affect its safety or effectiveness.