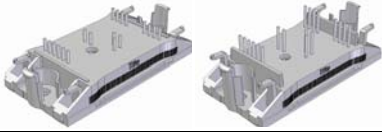
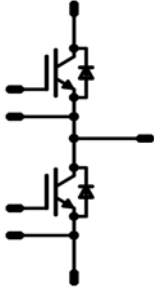

flowPHASE0	1200V/150A
<div style="border: 1px solid black; padding: 5px; margin-bottom: 5px;"> <p style="text-align: center; background-color: #000080; color: white; margin: 0;">Features</p> <ul style="list-style-type: none"> Trench Fieldstop IGBT⁴ technology 2-clip housing in 12mm and 17mm height Compact and low inductance design AlN substrate for improved performance </div> <div style="border: 1px solid black; padding: 5px; margin-bottom: 5px;"> <p style="text-align: center; background-color: #000080; color: white; margin: 0;">Target Applications</p> <ul style="list-style-type: none"> Motor Drive UPS </div> <div style="border: 1px solid black; padding: 5px;"> <p style="text-align: center; background-color: #000080; color: white; margin: 0;">Types</p> <ul style="list-style-type: none"> FZ122PA150SC01 F0122PA150SC01 </div>	<div style="border: 1px solid black; padding: 5px; margin-bottom: 5px;"> <p style="text-align: center; background-color: #000080; color: white; margin: 0;">flow0 housing</p>  </div> <div style="border: 1px solid black; padding: 5px;"> <p style="text-align: center; background-color: #000080; color: white; margin: 0;">Schematic</p>  </div>

Maximum Ratings

$T_j=25^{\circ}\text{C}$, unless otherwise specified

Parameter	Symbol	Condition	Value	Unit
Inverter Transistor				
Collector-emitter break down voltage	V_{CE}		1200	V
DC collector current	I_C	$T_j=T_{jmax}$ $T_h=80^{\circ}\text{C}$ $T_c=80^{\circ}\text{C}$	134 172	A
Repetitive peak collector current	I_{Cpulse}	t_p limited by T_{jmax}	450	A
Power dissipation per IGBT	P_{tot}	$T_j=T_{jmax}$ $T_h=80^{\circ}\text{C}$ $T_c=80^{\circ}\text{C}$	318 481	W
Gate-emitter peak voltage	V_{GE}		± 20	V
Short circuit ratings	t_{SC} V_{CC}	$T_j \leq 150^{\circ}\text{C}$ $V_{GE} = 15\text{V}$	10 800	μs V
Maximum Junction Temperature	T_{jmax}		175	$^{\circ}\text{C}$
Inverter Diode				
Peak Repetitive Reverse Voltage	V_{RRM}	$T_j=25^{\circ}\text{C}$	1200	V
DC forward current	I_F	$T_j=T_{jmax}$ $T_h=80^{\circ}\text{C}$ $T_c=80^{\circ}\text{C}$	120 158	A
Repetitive peak forward current	I_{FRM}	t_p limited by T_{jmax}	300	A
Power dissipation per Diode	P_{tot}	$T_j=T_{jmax}$ $T_h=80^{\circ}\text{C}$ $T_c=80^{\circ}\text{C}$	206 313	W
Maximum Junction Temperature	T_{jmax}		175	$^{\circ}\text{C}$

Maximum Ratings

 $T_j=25^{\circ}\text{C}$, unless otherwise specified

Parameter	Symbol	Condition	Value	Unit
-----------	--------	-----------	-------	------

Thermal Properties

Storage temperature	T_{stg}		-40...+125	$^{\circ}\text{C}$
Operation temperature under switching condition	T_{op}		-40...+(T_{jmax} - 25)	$^{\circ}\text{C}$

Insulation Properties

Insulation voltage	V_{is}	$t=2\text{s}$ DC voltage	4000	V
Creepage distance			min 12,7	mm
Clearance			min 12,7	mm

Characteristic Values

Parameter	Symbol	Conditions					Value			Unit					
		$V_{GE}[V]$ or $V_{GS}[V]$	$V_r[V]$ or $V_{CE}[V]$ or $V_{DS}[V]$	$I_c[A]$ or $I_F[A]$ or $I_b[A]$	T_j	Min	Typ	Max							
Inverter Transistor															
Gate emitter threshold voltage	$V_{GE(th)}$	$V_{CE}=V_{GE}$			0,0054	$T_j=25^\circ C$ $T_j=150^\circ C$	5	5,8	6,5	V					
Collector-emitter saturation voltage	$V_{CE(sat)}$		15		150	$T_j=25^\circ C$ $T_j=150^\circ C$	1,4	1,98 2,43	2,4	V					
Collector-emitter cut-off current incl. Diode	I_{CES}		0	1200		$T_j=25^\circ C$ $T_j=150^\circ C$			0,02	mA					
Gate-emitter leakage current	I_{GES}		20	0		$T_j=25^\circ C$ $T_j=150^\circ C$			700	nA					
Integrated Gate resistor	R_{gint}							5		Ω					
Turn-on delay time	$t_{d(on)}$	$R_{goff}=2 \Omega$ $R_{gon}=2 \Omega$	± 15	600	150	$T_j=25^\circ C$		185		ns					
Rise time	t_r					$T_j=150^\circ C$		204							
Turn-off delay time	$t_{d(off)}$					$T_j=25^\circ C$		28							
Fall time	t_f					$T_j=150^\circ C$		37							
Turn-on energy loss per pulse	E_{on}					$T_j=25^\circ C$		305							
Turn-off energy loss per pulse	E_{off}					$T_j=150^\circ C$		387							
Input capacitance	C_{ies}										$T_j=25^\circ C$		79		mWs
Output capacitance	C_{oss}	$f=1MHz$	0	25		$T_j=25^\circ C$		116							
Reverse transfer capacitance	C_{rss}							8,89		pF					
Gate charge	Q_{Gate}		± 15			$T_j=25^\circ C$		14,15							
Thermal resistance chip to heatsink per chip	R_{thJH}	Thermal foil thickness=76um						9,11		K/W					
Thermal resistance chip to case per chip	R_{thJC}	Kunze foil KU-ALF5						14,92							
Inverter Diode															
Diode forward voltage	V_F				50	$T_j=25^\circ C$ $T_j=150^\circ C$	1	1,91	2,4	V					
Peak reverse recovery current	I_{RRM}	$R_{gon}=2 \Omega$	± 15	600	150	$T_j=25^\circ C$		183,3		A					
Reverse recovery time	t_{rr}					$T_j=150^\circ C$		209,5							
Reverse recovered charge	Q_{rr}					$T_j=25^\circ C$		126,5							
Peak rate of fall of recovery current	$di(rec)max/dt$					$T_j=150^\circ C$		298,3							
Reverse recovered energy	E_{rec}					$T_j=25^\circ C$		13,93							
Thermal resistance chip to heatsink per chip	R_{thJH}					Thermal foil thickness=76um							26,55		μC
Thermal resistance chip to case per chip	R_{thJC}					Kunze foil KU-ALF5							3265		
								2538		A/ μs					
								5,21							
								10,45		mWs					
								0,46							

Output Inverter

Figure 1 Output inverter IGBT

Typical output characteristics

$$I_C = f(V_{CE})$$

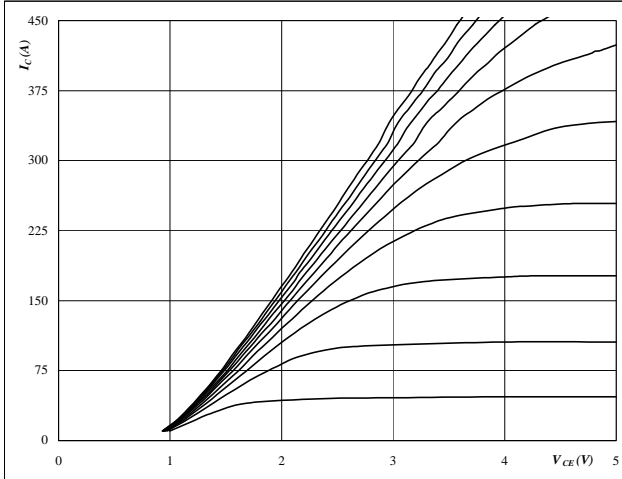

At
 $t_p = 350 \mu s$
 $T_j = 25^\circ C$
 V_{GE} from 7 V to 17 V in steps of 1 V

Figure 2 Output inverter IGBT

Typical output characteristics

$$I_C = f(V_{CE})$$

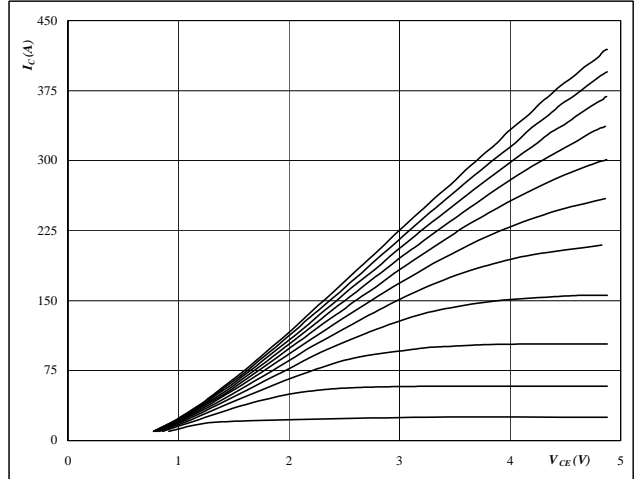

At
 $t_p = 350 \mu s$
 $T_j = 150^\circ C$
 V_{GE} from 7 V to 17 V in steps of 1 V

Figure 3 Output inverter IGBT

Typical transfer characteristics

$$I_C = f(V_{GE})$$

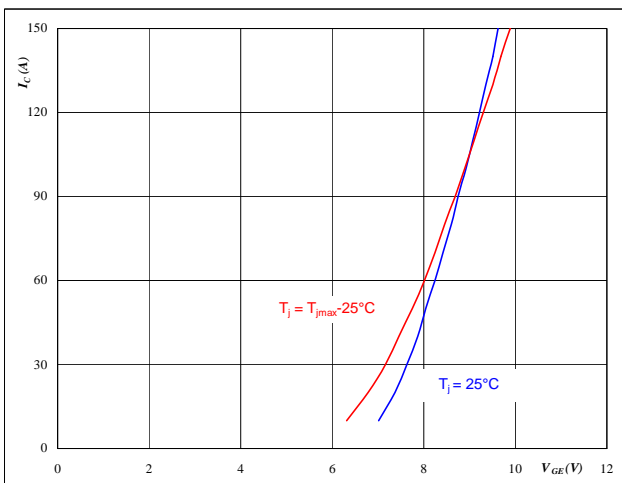

At
 $t_p = 350 \mu s$
 $V_{CE} = 10 V$

Figure 4 Output inverter FRED

Typical diode forward current as a function of forward voltage

$$I_F = f(V_F)$$

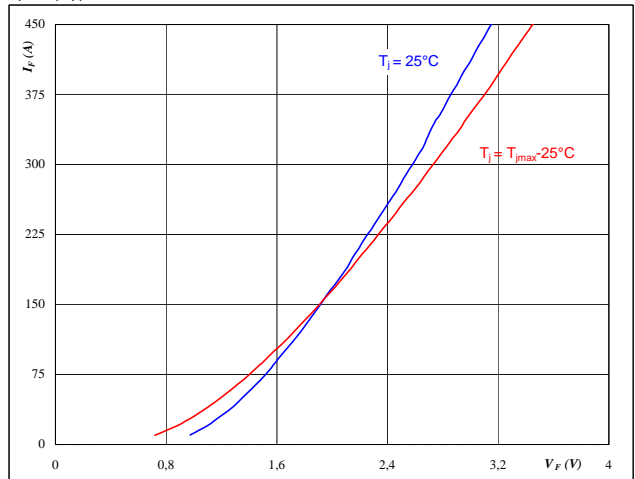

At
 $t_p = 350 \mu s$

Output Inverter

Figure 5 Output inverter IGBT

Typical switching energy losses
 as a function of collector current

$$E = f(I_C)$$

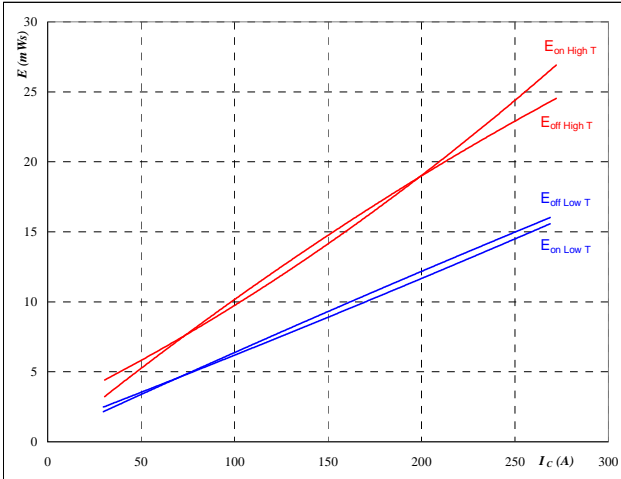

With an inductive load at

$T_J =$	25/150	°C
$V_{CE} =$	600	V
$V_{GE} =$	±15	V
$R_{gon} =$	2	Ω
$R_{goff} =$	2	Ω

Figure 6 Output inverter IGBT

Typical switching energy losses
 as a function of gate resistor

$$E = f(R_G)$$

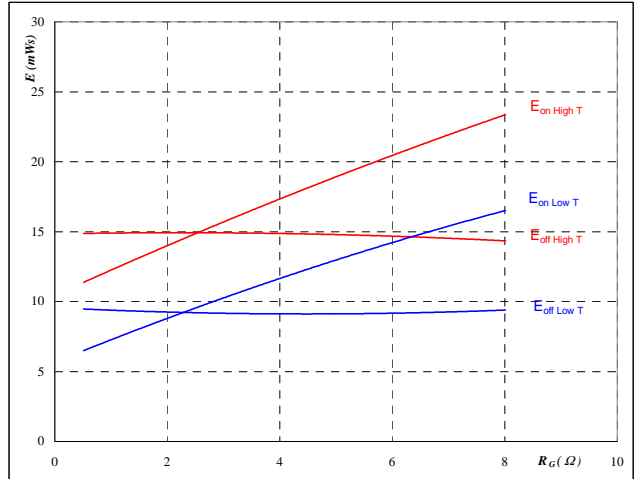

With an inductive load at

$T_J =$	25/150	°C
$V_{CE} =$	600	V
$V_{GE} =$	±15	V
$I_C =$	150	A

Figure 7 Output inverter IGBT

Typical reverse recovery energy loss
 as a function of collector current

$$E_{rec} = f(I_C)$$

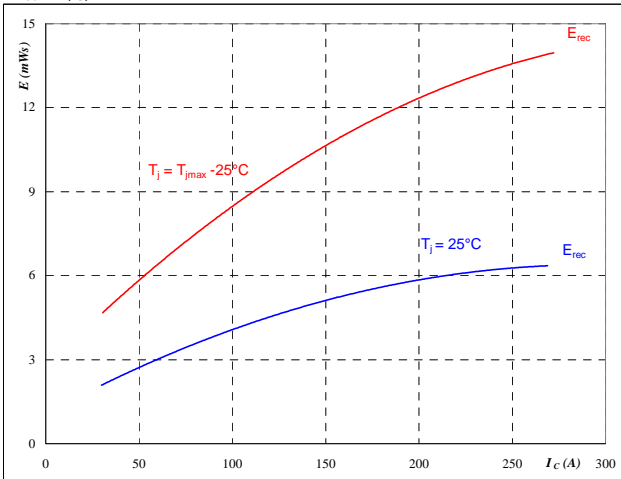

With an inductive load at

$T_J =$	25/150	°C
$V_{CE} =$	600	V
$V_{GE} =$	±15	V
$R_{gon} =$	2	Ω

Figure 8 Output inverter IGBT

Typical reverse recovery energy loss
 as a function of gate resistor

$$E_{rec} = f(R_G)$$

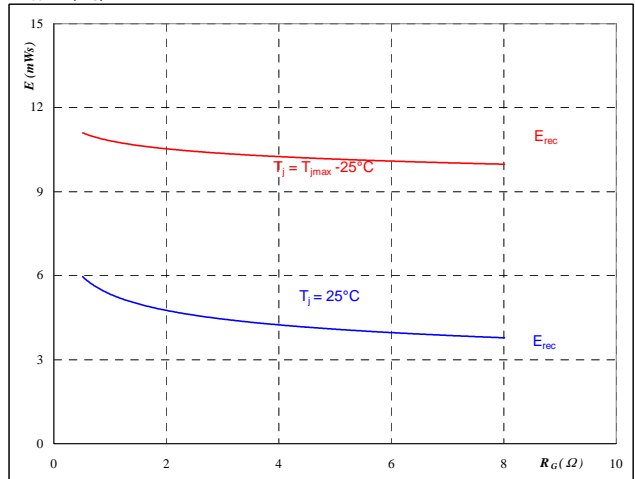

With an inductive load at

$T_J =$	25/150	°C
$V_{CE} =$	600	V
$V_{GE} =$	±15	V
$I_C =$	150	A

Output Inverter

Figure 9 Output inverter IGBT

Typical switching times as a function of collector current

$$t = f(I_C)$$

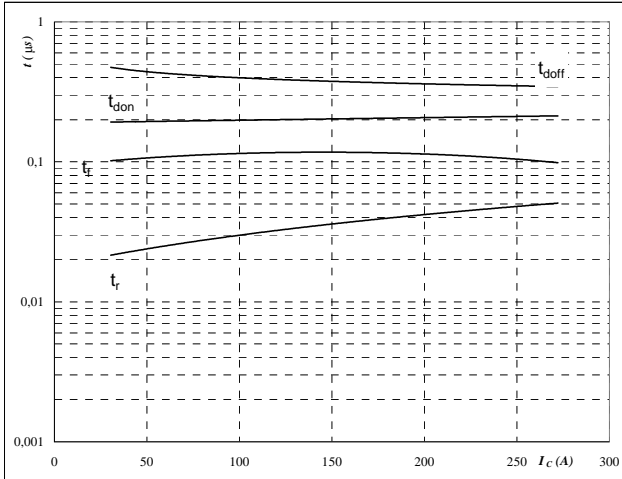

With an inductive load at

$T_J =$	150	°C
$V_{CE} =$	600	V
$V_{GE} =$	±15	V
$R_{gon} =$	2	Ω
$R_{goff} =$	2	Ω

Figure 10 Output inverter IGBT

Typical switching times as a function of gate resistor

$$t = f(R_G)$$

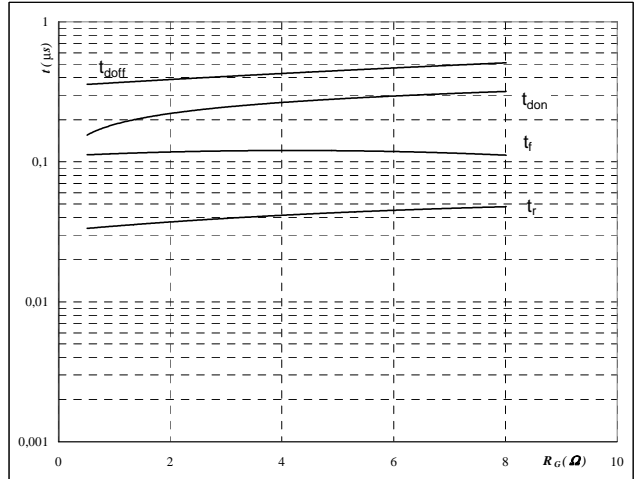

With an inductive load at

$T_J =$	150	°C
$V_{CE} =$	600	V
$V_{GE} =$	±15	V
$I_C =$	150	A

Figure 11 Output inverter FRED

Typical reverse recovery time as a function of collector current

$$t_{rr} = f(I_C)$$

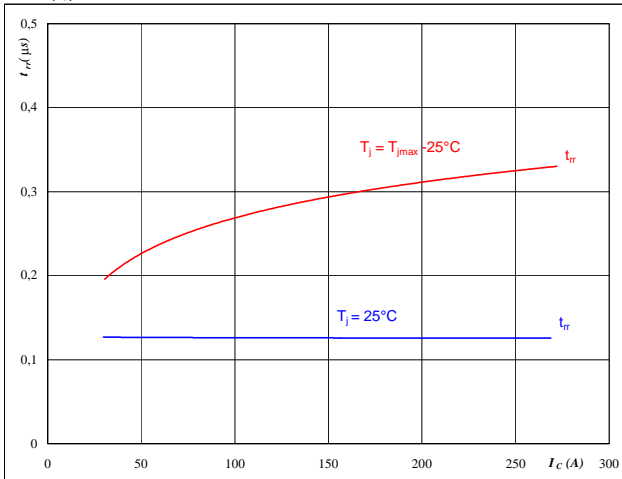

At

$T_J =$	25/150	°C
$V_{CE} =$	600	V
$V_{GE} =$	±15	V
$R_{gon} =$	2	Ω

Figure 12 Output inverter FRED

Typical reverse recovery time as a function of IGBT turn on gate resistor

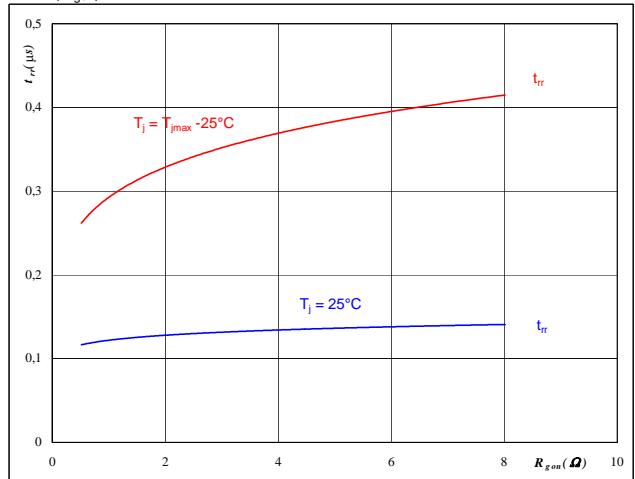
$$t_{rr} = f(R_{gon})$$

At

$T_J =$	25/150	°C
$V_R =$	600	V
$I_F =$	150	A
$V_{GE} =$	±15	V

Output Inverter

Figure 13 Output inverter FRED

Typical reverse recovery charge as a function of collector current

$$Q_{rr} = f(I_C)$$

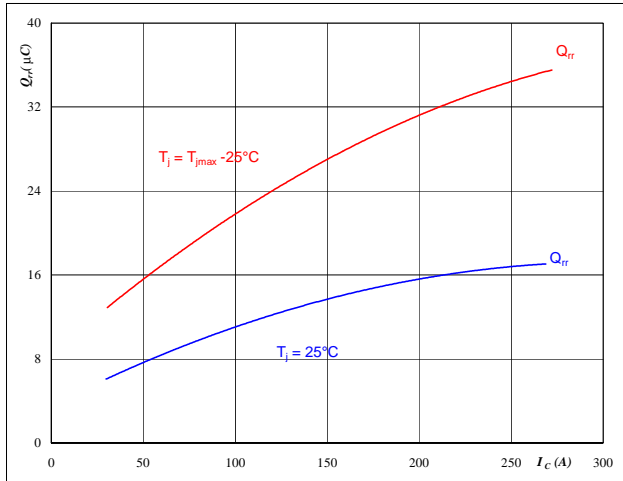

At

$T_j =$	25/150	°C
$V_{CE} =$	600	V
$V_{GE} =$	±15	V
$R_{gon} =$	2	Ω

Figure 14 Output inverter FRED

Typical reverse recovery charge as a function of IGBT turn on gate resistor

$$Q_{rr} = f(R_{gon})$$

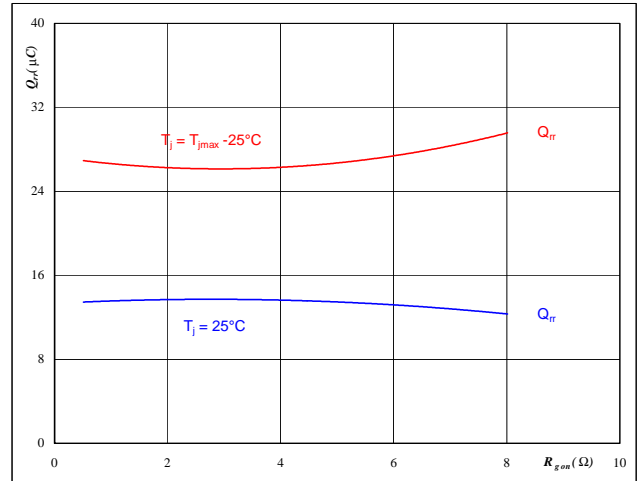

At

$T_j =$	25/150	°C
$V_R =$	600	V
$I_F =$	150	A
$V_{GE} =$	±15	V

Figure 15 Output inverter FRED

Typical reverse recovery current as a function of collector current

$$I_{RRM} = f(I_C)$$

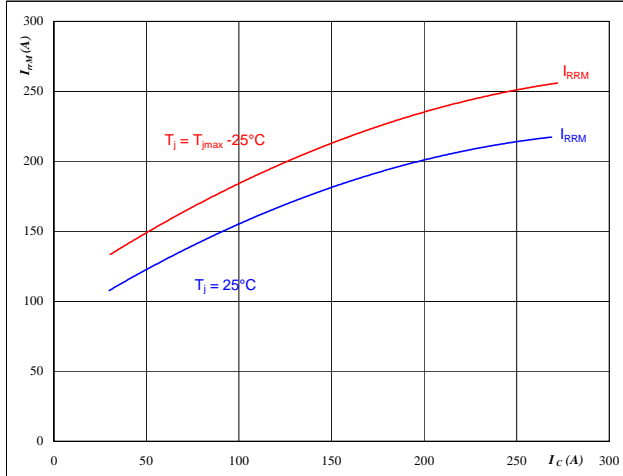

At

$T_j =$	25/150	°C
$V_{CE} =$	600	V
$V_{GE} =$	±15	V
$R_{gon} =$	2	Ω

Figure 16 Output inverter FRED

Typical reverse recovery current as a function of IGBT turn on gate resistor

$$I_{RRM} = f(R_{gon})$$

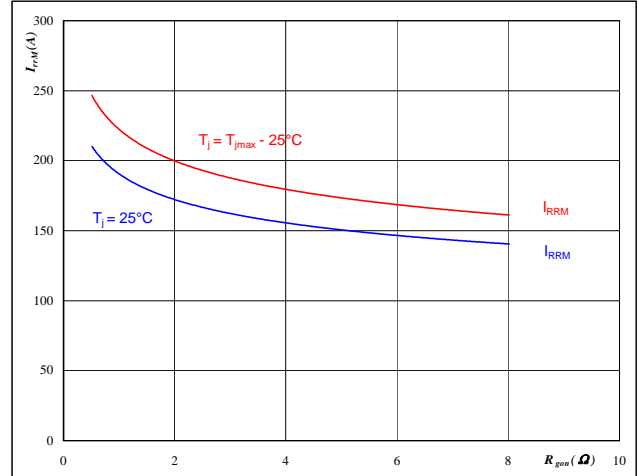

At

$T_j =$	25/150	°C
$V_R =$	600	V
$I_F =$	150	A
$V_{GE} =$	±15	V

Output Inverter

Figure 17 Output inverter FRED

Typical rate of fall of forward and reverse recovery current as a function of collector current

$$di_o/dt, di_{rec}/dt = f(I_c)$$

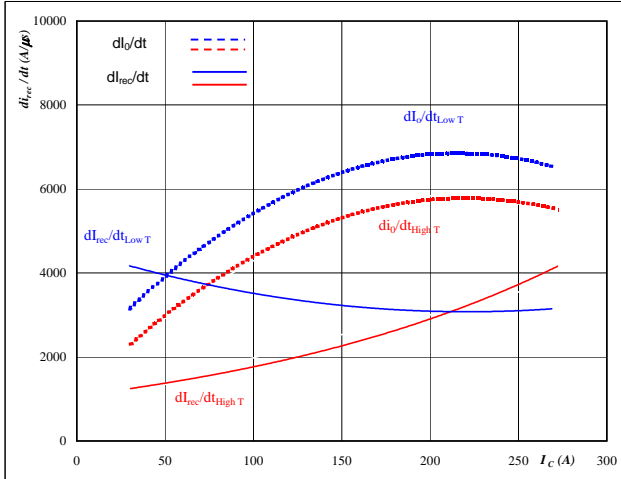

At
 $T_j = 25/150$ °C
 $V_{CE} = 600$ V
 $V_{GE} = \pm 15$ V
 $R_{gon} = 2$ Ω

Figure 18 Output inverter FRED

Typical rate of fall of forward and reverse recovery current as a function of IGBT turn on gate resistor

$$di_o/dt, di_{rec}/dt = f(R_{gon})$$

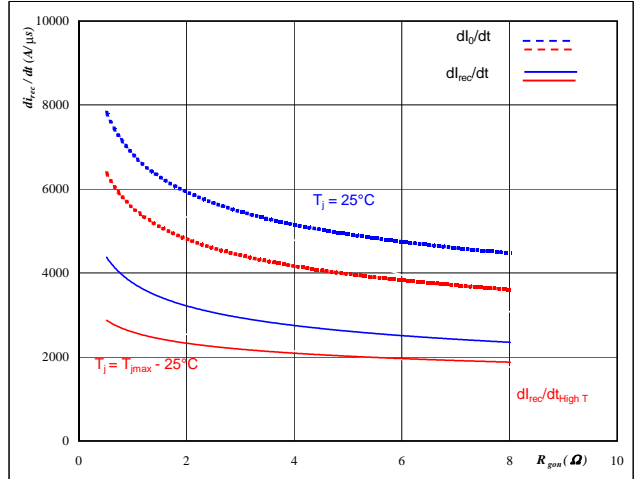

At
 $T_j = 25/150$ °C
 $V_R = 600$ V
 $I_F = 150$ A
 $V_{GE} = \pm 15$ V

Figure 19 Output inverter IGBT

IGBT transient thermal impedance as a function of pulse width

$$Z_{thJH} = f(t_p)$$

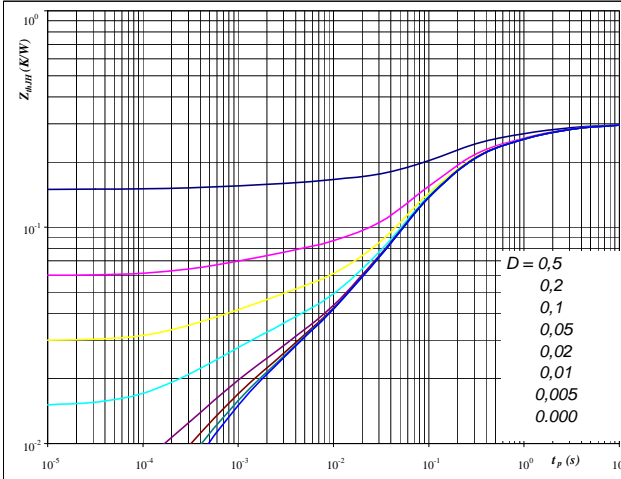

At
 $D = t_p / T$
 $R_{thJH} = 0,30$ K/W

IGBT thermal model values

R (C/W)	Tau (s)
0,03	4,2E+00
0,06	9,9E-01
0,13	1,6E-01
0,05	4,8E-02
0,01	2,5E-03
0,01	3,5E-04

Figure 20 Output inverter FRED

FRED transient thermal impedance as a function of pulse width

$$Z_{thJH} = f(t_p)$$

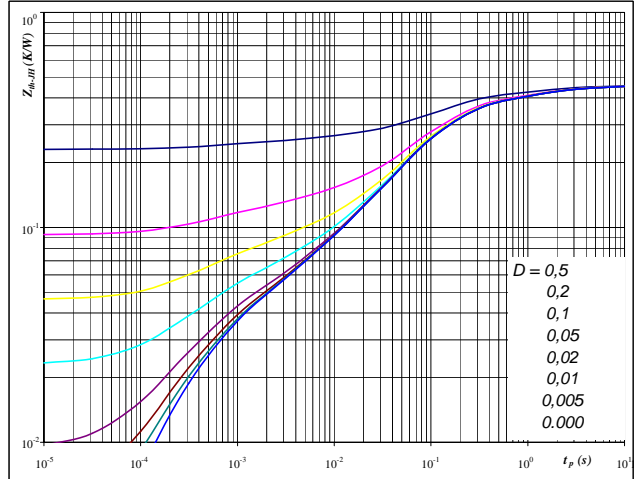

At
 $D = t_p / T$
 $R_{thJH} = 0,46$ K/W

FRED thermal model values

R (C/W)	Tau (s)
0,02	8,2E+00
0,08	1,0E+00
0,20	1,3E-01
0,09	3,9E-02
0,03	2,9E-03
0,03	3,9E-04

Output Inverter

Figure 21 Output inverter IGBT

Power dissipation as a function of heatsink temperature

$$P_{tot} = f(T_h)$$

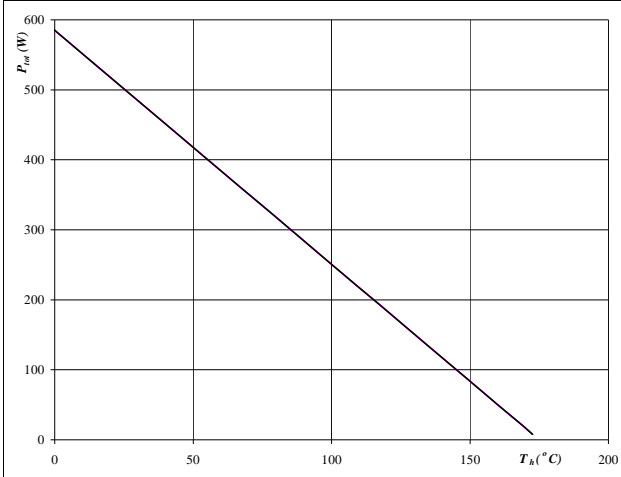

At $T_j = 175$ °C

— single heating
— overall heating

Figure 22 Output inverter IGBT

Collector current as a function of heatsink temperature

$$I_C = f(T_h)$$

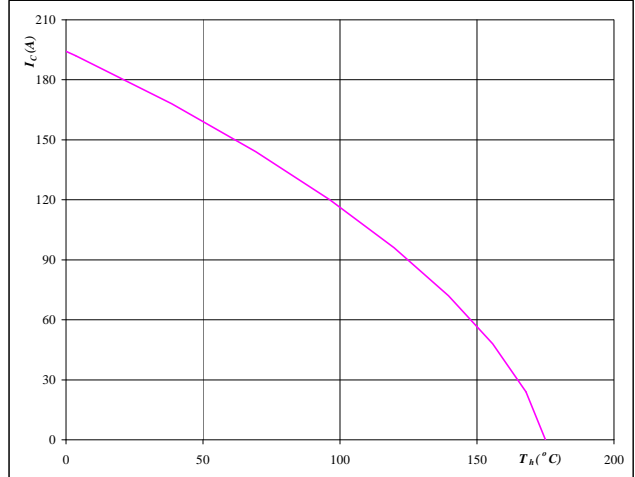

At $T_j = 175$ °C
 $V_{GE} = 15$ V

Figure 23 Output inverter FRED

Power dissipation as a function of heatsink temperature

$$P_{tot} = f(T_h)$$

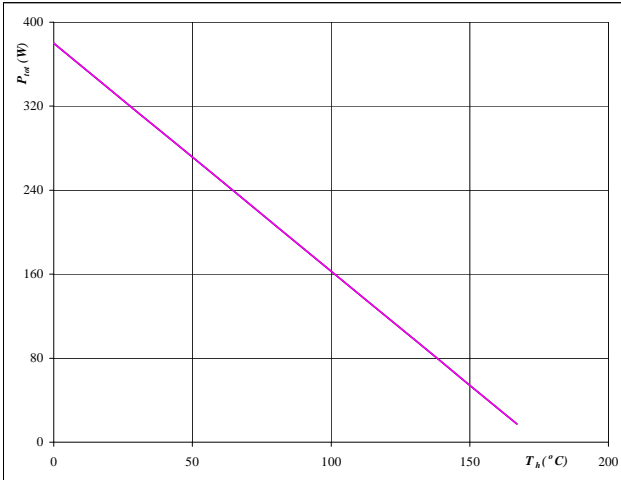

At $T_j = 175$ °C

— single heating
— overall heating

Figure 24 Output inverter FRED

Forward current as a function of heatsink temperature

$$I_F = f(T_h)$$

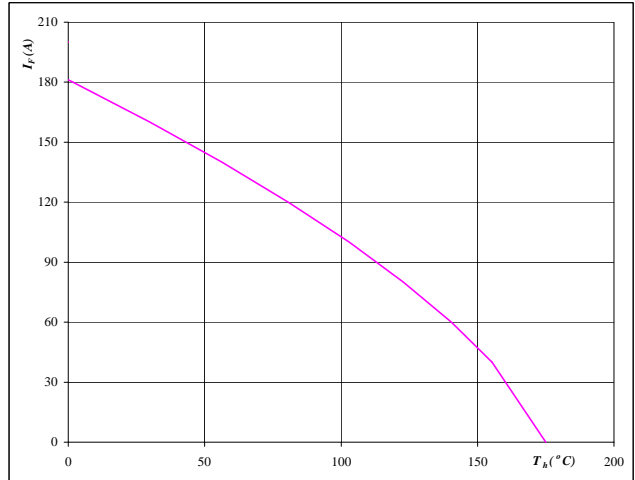

At $T_j = 175$ °C

Output Inverter

Figure 25 Output inverter IGBT

Safe operating area as a function
of collector-emitter voltage
 $I_C = f(V_{CE})$

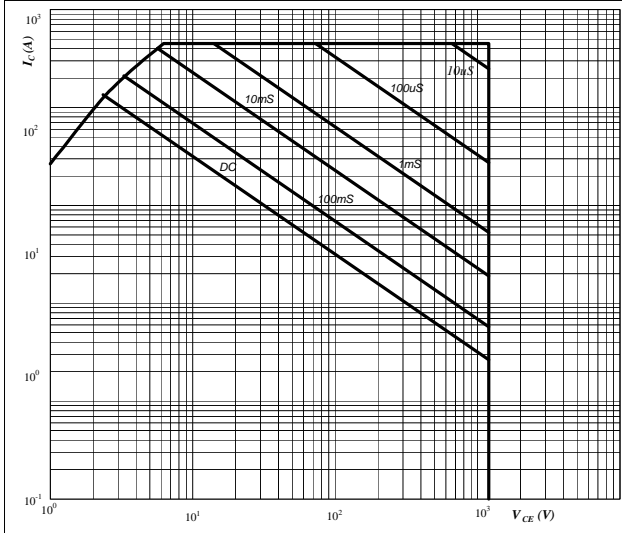

At
 D = single pulse
 $T_h = 80$ °C
 $V_{GE} = \pm 15$ V
 $T_j = T_{jmax}$ °C

Figure 26 Output inverter IGBT

Gate voltage vs Gate charge

$V_{GE} = f(Q_{GE})$

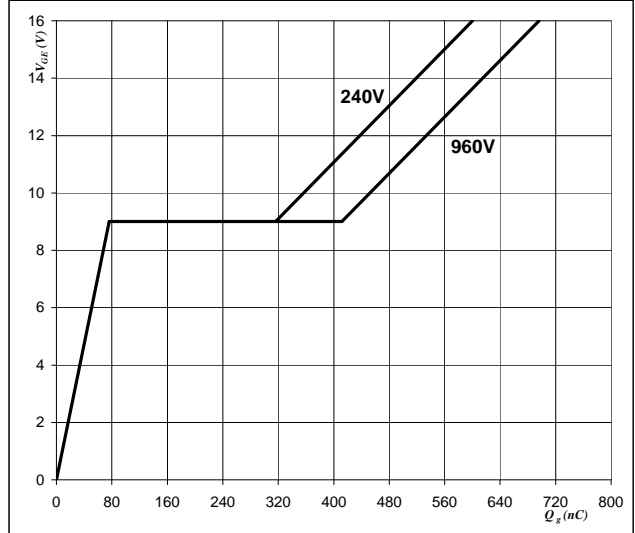

At
 $I_C = 150$ A

Switching Definitions Output Inverter

General conditions	
T_j	= 150 °C
R_{gon}	= 2 Ω
R_{goff}	= 2 Ω

Figure 1 Output inverter IGBT

Turn-off Switching Waveforms & definition of t_{doff} , t_{Eoff}
(t_{Eoff} = integrating time for E_{off})

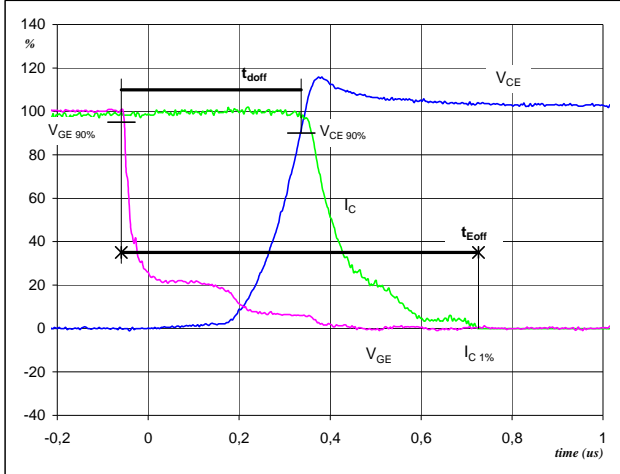

$V_{GE}(0\%)$	=	-15	V
$V_{GE}(100\%)$	=	15	V
$V_C(100\%)$	=	600	V
$I_C(100\%)$	=	150	A
t_{doff}	=	0,39	μs
t_{Eoff}	=	0,78	μs

Figure 2 Output inverter IGBT

Turn-on Switching Waveforms & definition of t_{don} , t_{Eon}
(t_{Eon} = integrating time for E_{on})

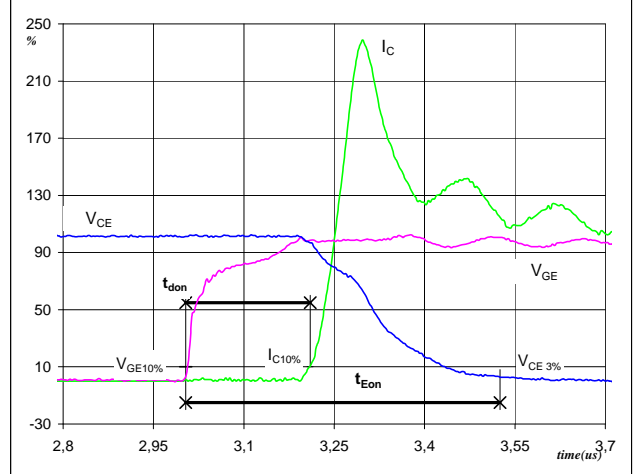

$V_{GE}(0\%)$	=	-15	V
$V_{GE}(100\%)$	=	15	V
$V_C(100\%)$	=	600	V
$I_C(100\%)$	=	150	A
t_{don}	=	0,20	μs
t_{Eon}	=	0,52	μs

Figure 3 Output inverter IGBT

Turn-off Switching Waveforms & definition of t_f

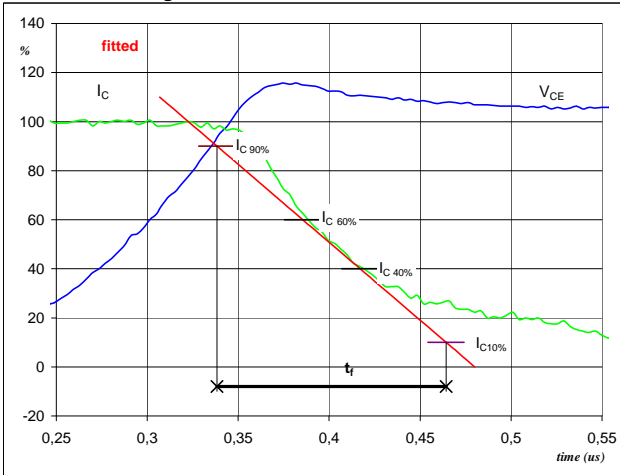

$V_C(100\%)$	=	600	V
$I_C(100\%)$	=	150	A
t_f	=	0,12	μs

Figure 4 Output inverter IGBT

Turn-on Switching Waveforms & definition of t_r

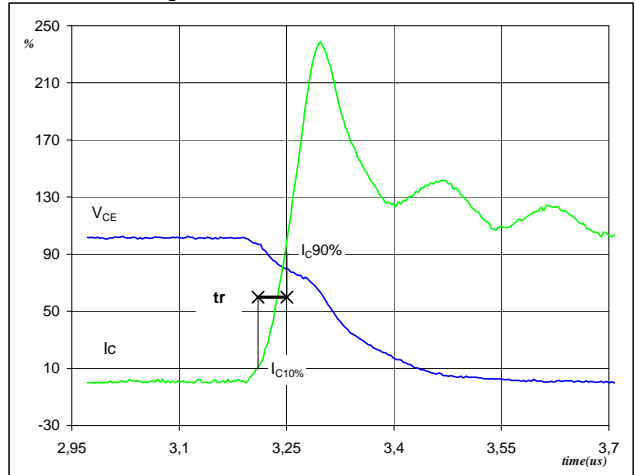

$V_C(100\%)$	=	600	V
$I_C(100\%)$	=	150	A
t_r	=	0,04	μs

Switching Definitions Output Inverter

Figure 5 Output inverter IGBT

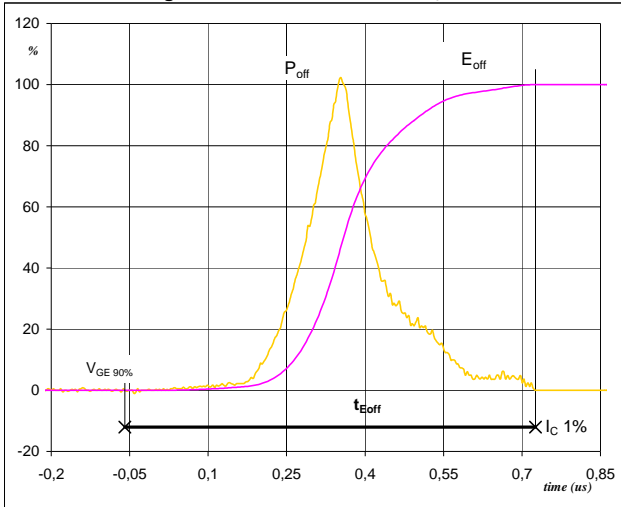
Turn-off Switching Waveforms & definition of t_{Eoff}

$P_{off} (100\%) = 90,25 \text{ kW}$
 $E_{off} (100\%) = 14,92 \text{ mJ}$
 $t_{Eoff} = 0,78 \text{ }\mu\text{s}$

Figure 6 Output inverter IGBT

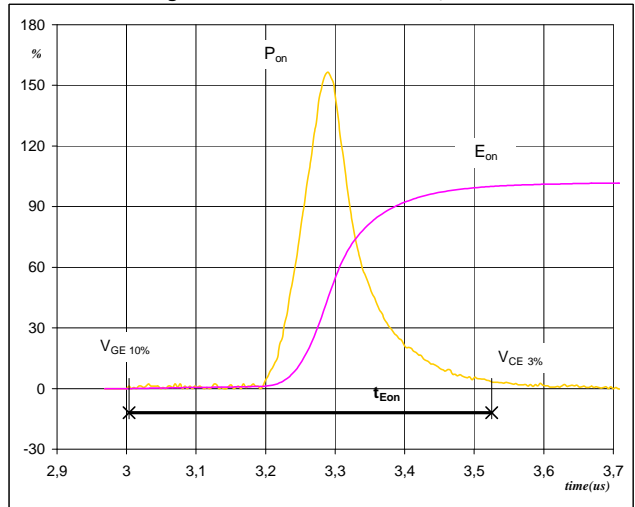
Turn-on Switching Waveforms & definition of t_{Eon}

$P_{on} (100\%) = 90,25 \text{ kW}$
 $E_{on} (100\%) = 14,15 \text{ mJ}$
 $t_{Eon} = 0,52 \text{ }\mu\text{s}$

Figure 7 Output inverter FRED

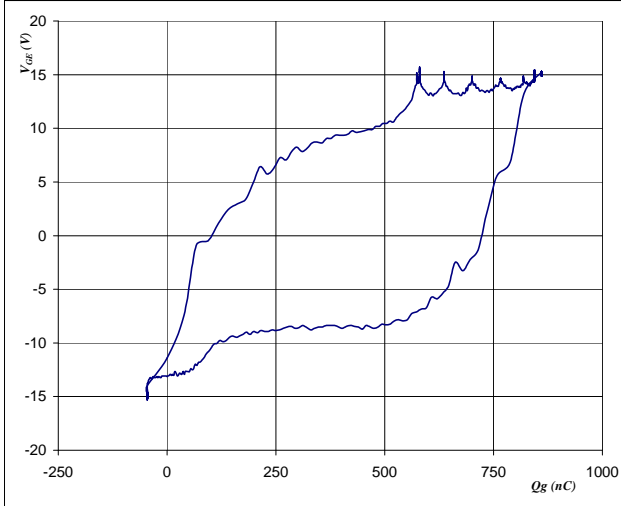
Gate voltage vs Gate charge (measured)

$V_{GEoff} = -15 \text{ V}$
 $V_{GEon} = 15 \text{ V}$
 $V_C (100\%) = 600 \text{ V}$
 $I_C (100\%) = 150 \text{ A}$
 $Q_g = 8359,90 \text{ nC}$

Figure 8 Output inverter IGBT

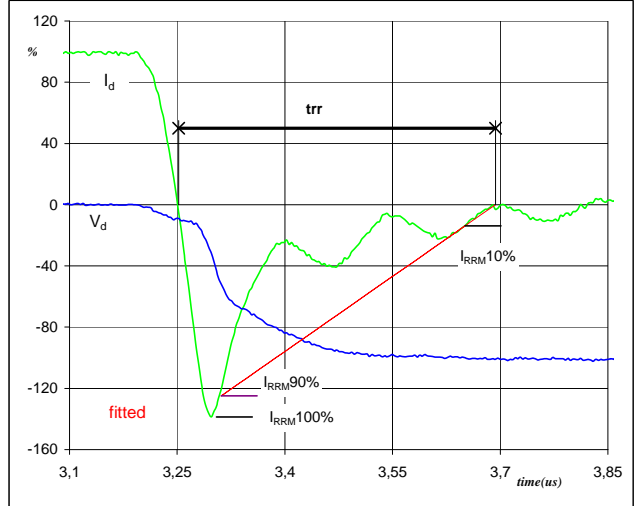
Turn-off Switching Waveforms & definition of t_{tr}

$V_d (100\%) = 600 \text{ V}$
 $I_d (100\%) = 150 \text{ A}$
 $I_{RRM} (100\%) = -210 \text{ A}$
 $t_{tr} = 0,30 \text{ }\mu\text{s}$

Switching Definitions Output Inverter

Figure 9 Output inverter FRED

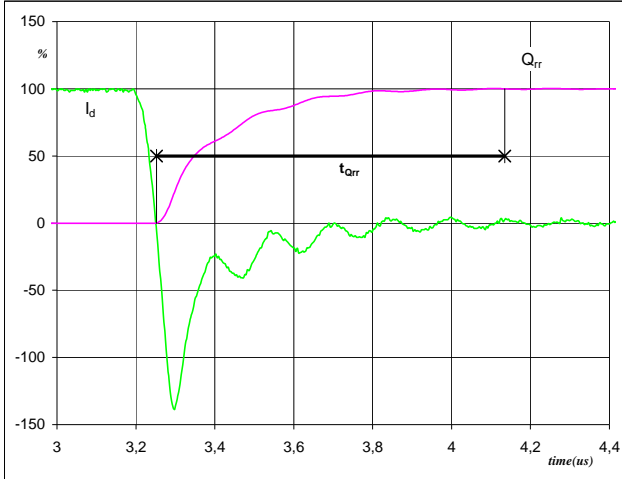
Turn-on Switching Waveforms & definition of t_{Qrr}
 (t_{Qrr} = integrating time for Q_{rr})

I_d (100%) =	150	A
Q_{rr} (100%) =	26,55	μC
t_{Qrr} =	0,88	μs

Figure 10 Output inverter FRED

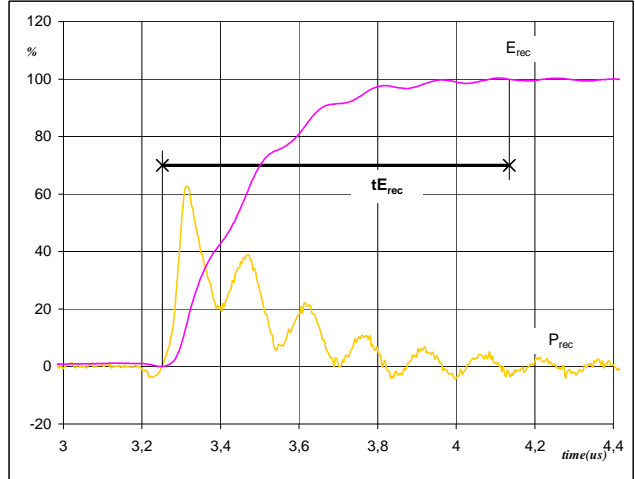
Turn-on Switching Waveforms & definition of $t_{E_{rec}}$
 ($t_{E_{rec}}$ = integrating time for E_{rec})

P_{rec} (100%) =	90,25	kW
E_{rec} (100%) =	10,45	mJ
$t_{E_{rec}}$ =	0,88	μs

Ordering Code and Marking - Outline - Pinout
Ordering Code & Marking

Version	Ordering Code	in DataMatrix as	in packaging barcode as
without thermal paste 12mm housing	10-FZ122PA150SC01-P990F18	P990F18	P990F18
without thermal paste 17mm housing	10-F0122PA150SC01-P990F19	P990F19	P990F19

Outline

Pin table		
Pin	X	Y
1	0	0
2	0	2,3
3	0	4,6
4	0	6,9
5	0	15,6
6	0	17,9
7	0	20,2
8	0	22,5
9	13,85	16,45
10	16,75	16,45
11	33,5	11,5
12	33,5	9,2
13	33,5	6,9
14	33,5	4,6
15	33,5	2,3
16	33,5	0
17	13,85	13,55
18	19,55	4,95
19	19,55	7,85

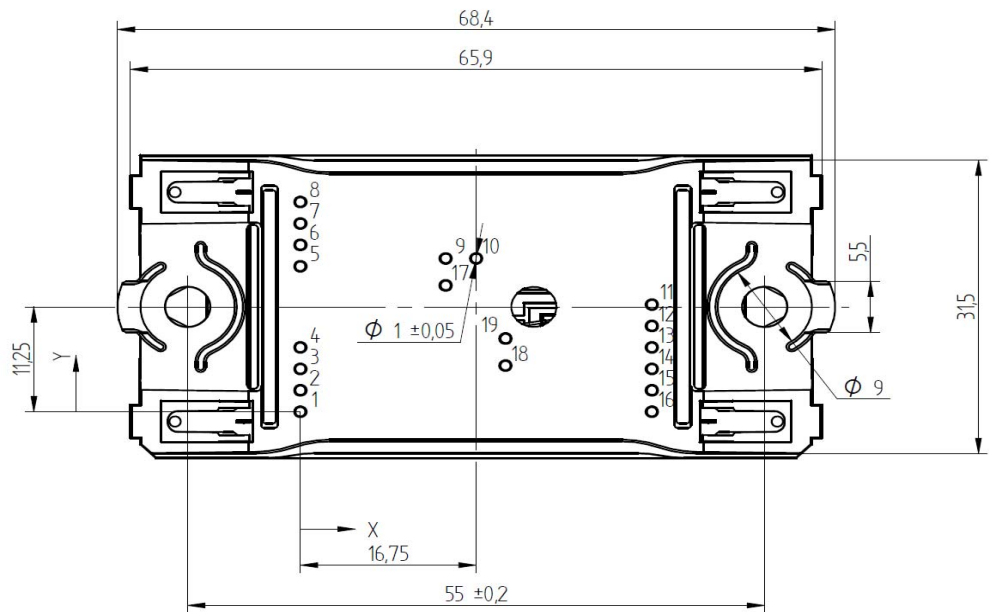
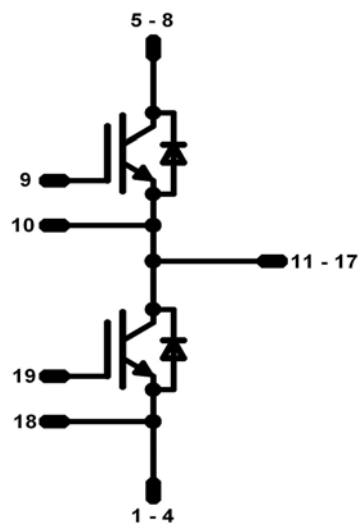
Pinout

PRODUCT STATUS DEFINITIONS

Datasheet Status	Product Status	Definition
Target	Formative or In Design	This datasheet contains the design specifications for product development. Specifications may change in any manner without notice. The data contained is exclusively intended for technically trained staff.
Preliminary	First Production	This datasheet contains preliminary data, and supplementary data may be published at a later date. Vincotech reserves the right to make changes at any time without notice in order to improve design. The data contained is exclusively intended for technically trained staff.
Final	Full Production	This datasheet contains final specifications. Vincotech reserves the right to make changes at any time without notice in order to improve design. The data contained is exclusively intended for technically trained staff.

DISCLAIMER

The information given in this datasheet describes the type of component and does not represent assured characteristics. For tested values please contact Vincotech. Vincotech reserves the right to make changes without further notice to any products herein to improve reliability, function or design. Vincotech does not assume any liability arising out of the application or use of any product or circuit described herein; neither does it convey any license under its patent rights, nor the rights of others.

LIFE SUPPORT POLICY

Vincotech products are not authorised for use as critical components in life support devices or systems without the express written approval of Vincotech.

As used herein:

1. Life support devices or systems are devices or systems which, (a) are intended for surgical implant into the body, or (b) support or sustain life, or (c) whose failure to perform when properly used in accordance with instructions for use provided in labelling can be reasonably expected to result in significant injury to the user.
2. A critical component is any component of a life support device or system whose failure to perform can be reasonably expected to cause the failure of the life support device or system, or to affect its safety or effectiveness.