

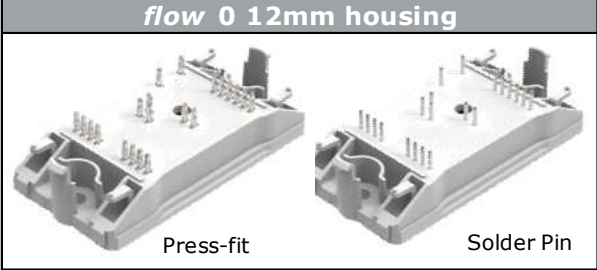
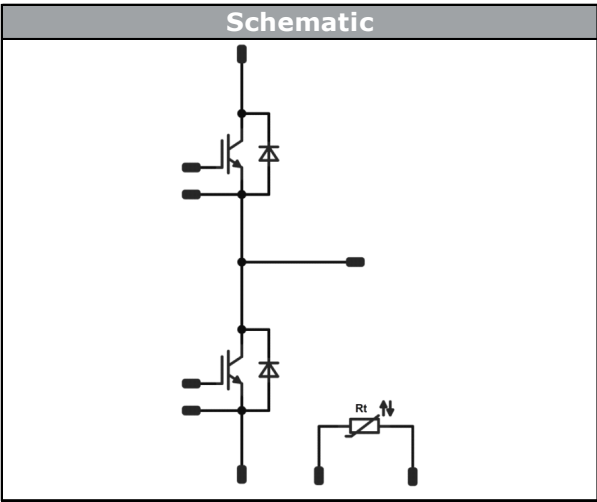

<i>flow</i> PHASE 0	1200 V / 80 A
<div style="border: 1px solid black; padding: 5px; margin-bottom: 5px;"> <p style="text-align: center; background-color: #ccc; margin: 0;"><b>Features</b></p> <ul style="list-style-type: none"> <li>High efficiency fast Fairchild IGBT</li> <li>Full current fast FWD</li> <li>Thermistor</li> </ul> </div> <div style="border: 1px solid black; padding: 5px; margin-bottom: 5px;"> <p style="text-align: center; background-color: #ccc; margin: 0;"><b>Target applications</b></p> <ul style="list-style-type: none"> <li>Industrial Drives</li> <li>Power Supply</li> <li>Solar</li> <li>UPS</li> <li>Welding</li> </ul> </div> <div style="border: 1px solid black; padding: 5px;"> <p style="text-align: center; background-color: #ccc; margin: 0;"><b>Types</b></p> <ul style="list-style-type: none"> <li>10-FZ122PB080FV-M818F88</li> <li>10-PZ122PB080FV-M818F88Y</li> </ul> </div>	<div style="border: 1px solid black; padding: 5px; margin-bottom: 5px;"> <p style="text-align: center; background-color: #ccc; margin: 0;"><i>flow</i> 0 12mm housing</p>  <p style="text-align: center; margin: 0;">Press-fit                      Solder Pin</p> </div> <div style="border: 1px solid black; padding: 5px;"> <p style="text-align: center; background-color: #ccc; margin: 0;"><b>Schematic</b></p>  </div>

## Maximum Ratings

$T_j = 25\text{ °C}$ , unless otherwise specified

Parameter	Symbol	Condition	Value	Unit
<b>Half Bridge Switch</b>				
Collector-emitter voltage	$V_{CES}$		1200	V
Collector current	$I_C$	$T_j = T_{jmax}$ $T_s = 80\text{ °C}$	79	A
Repetitive peak collector current	$I_{CRM}$	$t_p$ limited by $T_{jmax}$	320	A
Total power dissipation	$P_{tot}$	$T_j = T_{jmax}$ $T_s = 80\text{ °C}$	209	W
Gate-emitter voltage	$V_{GES}$		±20	V
Maximum junction temperature	$T_{jmax}$		175	°C



## Maximum Ratings

$T_j = 25\text{ °C}$ , unless otherwise specified

Parameter	Symbol	Condition	Value	Unit
<b>Half Bridge FWD</b>				
Peak Repetitive Reverse Voltage	$V_{RRM}$		1200	V
Continuous (direct) forward current	$I_F$	$T_j = T_{jmax}$ $T_s = 80\text{ °C}$	56	A
Total power dissipation	$P_{tot}$	$T_j = T_{jmax}$ $T_s = 80\text{ °C}$	106	W
Maximum Junction Temperature	$T_{jmax}$		175	°C

## Module Properties

### Thermal Properties

Storage temperature	$T_{stg}$		-40...+125	°C
Operation temperature under switching condition	$T_{jop}$		-40...( $T_{jmax} - 25$ )	°C

### Isolation Properties

Isolation voltage	$V_{sol}$	DC Test Voltage $t_p = 2\text{ s}$	4000	V
Creepage distance			min. 12,7	mm
Clearance with Press-fit			9,54	mm
Clearance with Solder Pin			9,12	mm
Comparative Tracking Index	CTI		> 200	



## Characteristic Values

Parameter	Symbol	Conditions					Value			Unit
		$V_{GS}$ [V]	$V_{GE}$ [V]	$V_{DS}$ [V]	$I_D$ [A]	$T_j$ [°C]	Min	Typ	Max	

### Half Bridge Switch

#### Static

Parameter	Symbol	$V_{GE} = V_{CE}$	$V_{GS}$ [V]	$V_{CE}$ [V]	$I_D$ [A]	$T_j$ [°C]	Min	Typ	Max	Unit
Gate-emitter threshold voltage	$V_{GE(th)}$				0,08	25	5	6,2	7,3	V
Collector-emitter saturation voltage	$V_{CEsat}$		15		80	25 125 150	1,5	2,38 2,54 2,58	2,5	V
Collector-emitter cut-off current	$I_{CES}$		0	1200		25			100	μA
Gate-emitter leakage current	$I_{GES}$		25	0		25			500	nA
Internal gate resistance	$r_g$							none		Ω
Input capacitance	$C_{ies}$							8600		pF
Output capacitance	$C_{oes}$	$f = 1$ MHz	0	30		25		360		
Reverse transfer capacitance	$C_{res}$							200		
Gate charge	$Q_g$		15	600	80	25		740		nC

#### Thermal

Parameter	Symbol	Material	Min	Typ	Max	Unit
Thermal resistance junction to sink	$R_{th(j-s)}$	phase-change material $\lambda = 3,4$ W/mK				0,45 K/W

#### Dynamic

Parameter	Symbol	$R_{goff} = 4$ Ω $R_{gon} = 4$ Ω	$V_{GS}$ [V]	$V_{CE}$ [V]	$I_D$ [A]	$T_j$ [°C]	Min	Typ	Max	Unit
Turn-on delay time	$t_{d(on)}$		±15	600	80	25		143		ns
Rise time	$t_r$					125		145		
						150		146		
						25		19		
Turn-off delay time	$t_{d(off)}$	25		239						
		125		286						
		150		302						
Fall time	$t_f$			25		10				
Turn-on energy (per pulse)	$E_{on}$	$Q_{tFWD} = 6,2$ μC $Q_{tFWD} = 11,7$ μC $Q_{tFWD} = 13,9$ μC				25		3,834		mWs
						125		6,608		
						150		7,571		
Turn-off energy (per pulse)	$E_{off}$					25		2,647		
						125		4,686		
						150		5,489		



Vincotech

**10-FZ122PB080FV-M818F88**  
**10-PZ122PB080FV-M818F88Y**  
 datasheet

## Characteristic Values

Parameter	Symbol	Conditions					Value			Unit
		$V_{GE}$ [V]	$V_{GS}$ [V]	$V_{CE}$ [V]	$V_{DS}$ [V]	$I_C$ [A]	$I_D$ [A]	$I_F$ [A]	$T_j$ [°C]	

### Half Bridge FWD

#### Static

Forward voltage	$V_F$				75	25 150		2,19 2,18	2,49	V
Reverse leakage current	$I_r$			1200		25 150			120 14000	$\mu$ A

#### Thermal

Thermal resistance junction to sink	$R_{th(j-s)}$	phase-change material $\lambda=3,4$ W/mK						0,90		K/W
-------------------------------------	---------------	---	--	--	--	--	--	------	--	-----

#### Dynamic

Peak recovery current	$I_{RRM}$					25 125 150		79 81 85		A
Reverse recovery time	$t_{rr}$					25 125 150		160 440 482		ns
Recovered charge	$Q_r$	$di/dt = 4147$ A/ $\mu$ s $di/dt = 3102$ A/ $\mu$ s $di/dt = 3344$ A/ $\mu$ s	$\pm 15$	600	80	25 125 150		6,157 11,672 13,890		$\mu$ C
Reverse recovered energy	$E_{rec}$					25 125 150		2,432 4,634 5,469		mWs
Peak rate of fall of recovery current	$(di_{rr}/dt)_{max}$					25 125 150		2230 888 730		A/ $\mu$ s

### Thermistor

Rated resistance	R					25		22		k $\Omega$
Deviation of $R_{100}$	$\Delta_{R/R}$	$R_{100} = 1484 \Omega$				100	-5		5	%
Power dissipation	P					25		5		mW
Power dissipation constant						25		1,5		mW/K
B-value	$B_{(25/50)}$	Tol. $\pm 1$ %				25		3962		K
B-value	$B_{(25/100)}$	Tol. $\pm 1$ %				25		4000		K
Vincotech NTC Reference									I	



## Half Bridge Switch Characteristics

**figure 1.** IGBT

Typical output characteristics

$$I_C = f(V_{CE})$$

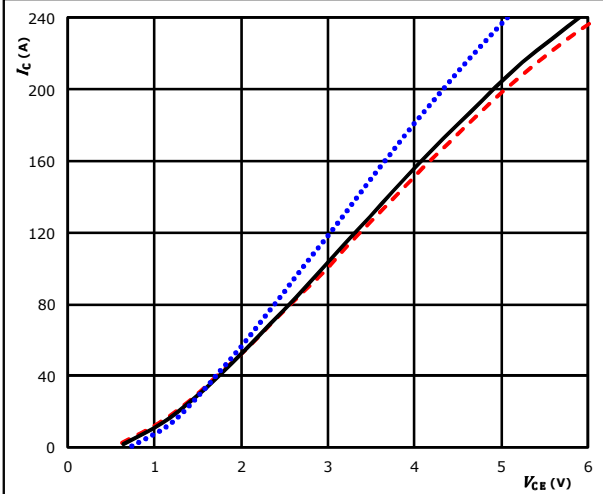

$t_p = 250 \mu\text{s}$   $V_{GE} = 15 \text{ V}$   $T_j: 25 \text{ }^\circ\text{C}$  (blue dotted)  
 $T_j: 125 \text{ }^\circ\text{C}$  (black solid)  
 $T_j: 150 \text{ }^\circ\text{C}$  (red dashed)

**figure 2.** IGBT

Typical output characteristics

$$I_C = f(V_{CE})$$

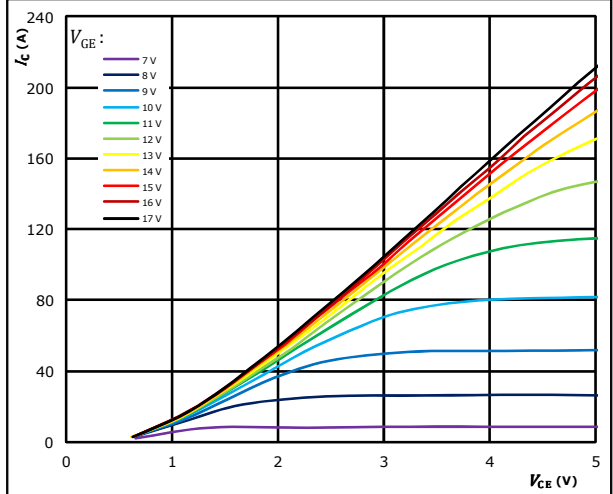

$t_p = 250 \mu\text{s}$   $T_j = 150 \text{ }^\circ\text{C}$   
 $V_{GE}$  from 7 V to 17 V in steps of 1 V

**figure 3.** IGBT

Typical transfer characteristics

$$I_C = f(V_{GE})$$

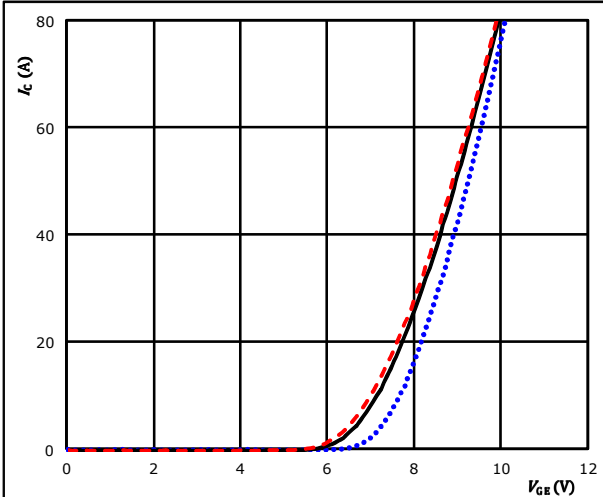

$t_p = 100 \mu\text{s}$   $V_{CE} = 10 \text{ V}$   $T_j: 25 \text{ }^\circ\text{C}$  (blue dotted)  
 $T_j: 125 \text{ }^\circ\text{C}$  (black solid)  
 $T_j: 150 \text{ }^\circ\text{C}$  (red dashed)

**figure 4.** IGBT

Transient thermal impedance as function of pulse duration

$$Z_{th(\theta-s)} = f(t_p)$$

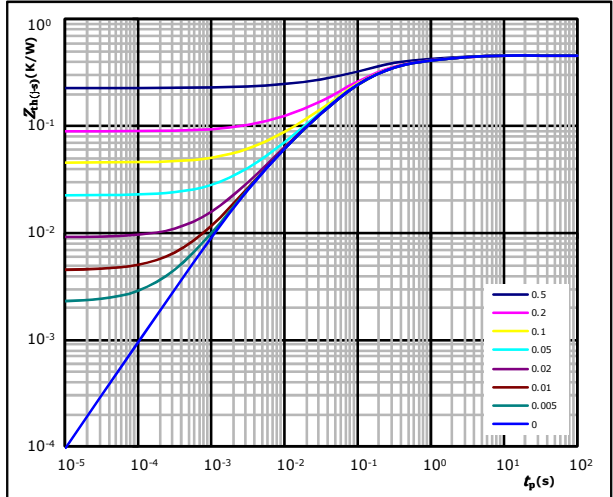

$D = t_p / T$   
 $R_{th(\theta-s)} = 0,45 \text{ K/W}$

IGBT thermal model values

$R$ (K/W)	$\tau$ (s)
6,41E-02	2,13E+00
9,83E-02	3,51E-01
2,34E-01	8,93E-02
4,25E-02	1,68E-02
1,54E-02	3,71E-03



## Half Bridge Switch Characteristics

**figure 5.** IGBT

Gate voltage vs gate charge

$V_{GE} = f(Q_G)$

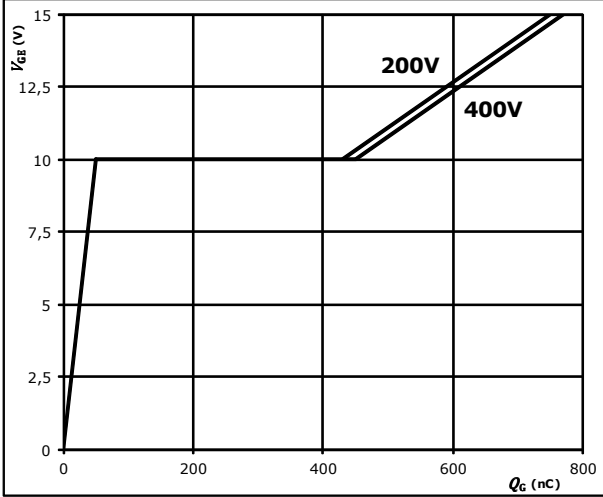

$I_C = 80$  A

**figure 6.** IGBT

Safe operating area

$I_C = f(V_{CE})$

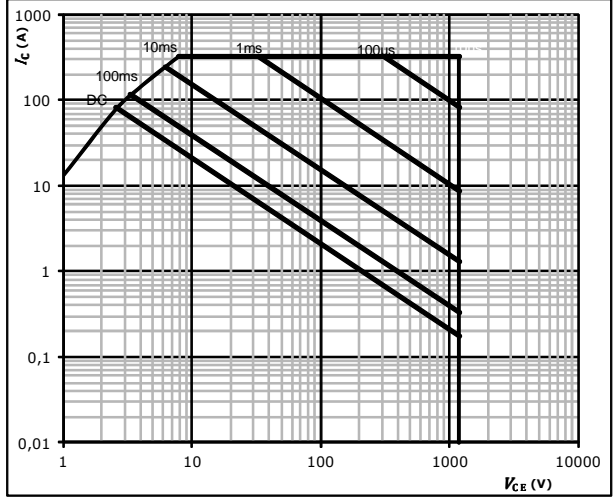

$D =$  single pulse  
 $T_s = 80$  °C  
 $V_{GE} = \pm 15$  V  
 $T_j = T_{jmax}$  °C



### Half Bridge FWD Characteristics

Typical forward characteristics **FWD**

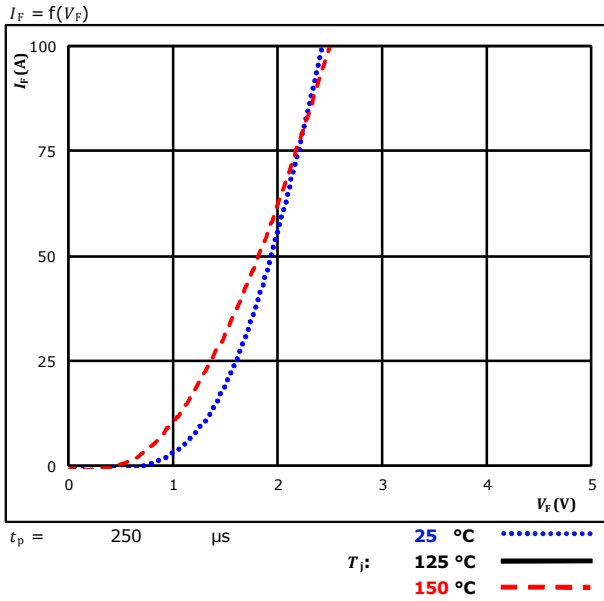

Transient thermal impedance as a function of pulse width **FWD**

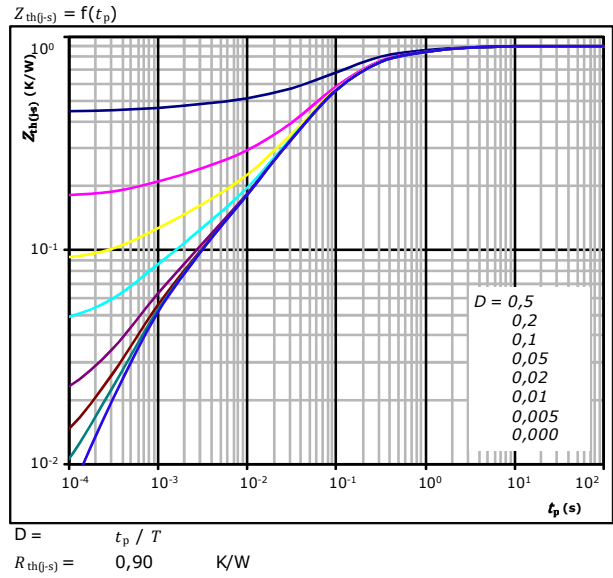

FWD thermal model values

R (K/W)	$\tau$ (s)
1,03E-01	1,48E+00
3,14E-01	1,79E-01
3,45E-01	5,85E-02
8,05E-02	8,67E-03
5,34E-02	9,71E-04



## Thermistor Characteristics

**Thermistor typical temperature characteristic**

**Typical NTC characteristic  
as a function of temperature**

$$R_T = f(T)$$

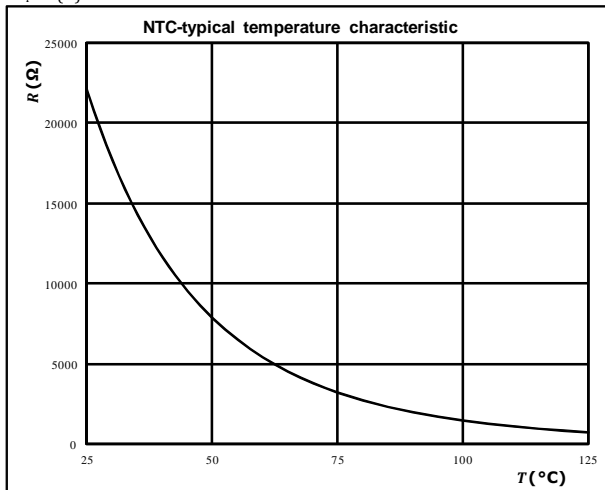





## Half Bridge Switching Characteristics

**figure 1.** IGBT

Typical switching energy losses as a function of collector current

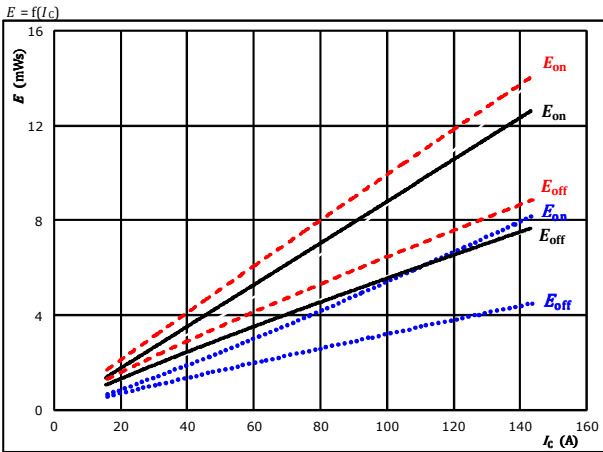

With an inductive load at  
 $V_{CE} = 600$  V  
 $V_{GE} = \pm 15$  V  
 $R_{g\text{on}} = 4$   $\Omega$   
 $R_{g\text{off}} = 4$   $\Omega$

$T_j$ : 25 °C (dotted blue), 125 °C (solid black), 150 °C (dashed red)

**figure 2.** IGBT

Typical switching energy losses as a function of gate resistor

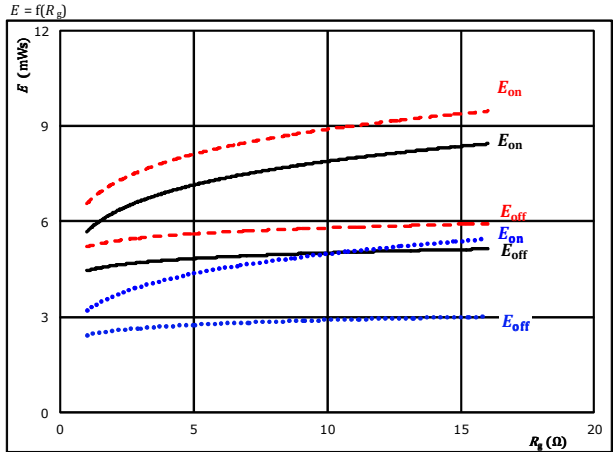

With an inductive load at  
 $V_{CE} = 600$  V  
 $V_{GE} = \pm 15$  V  
 $I_C = 80$  A

$T_j$ : 25 °C (dotted blue), 125 °C (solid black), 150 °C (dashed red)

**figure 3.** FWD

Typical reverse recovered energy loss as a function of collector current

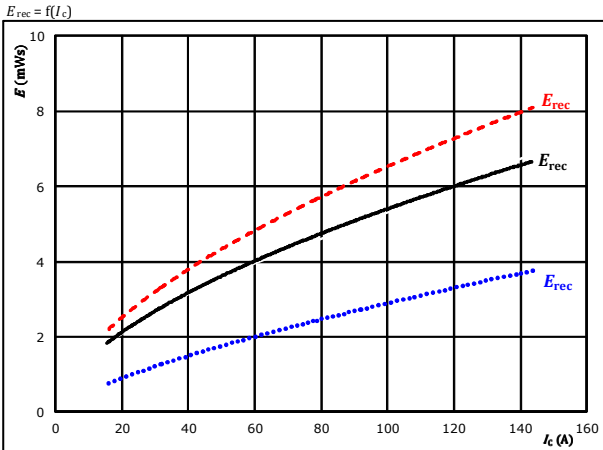

With an inductive load at  
 $V_{CE} = 600$  V  
 $V_{GE} = \pm 15$  V  
 $R_{g\text{on}} = 4$   $\Omega$

$T_j$ : 25 °C (dotted blue), 125 °C (solid black), 150 °C (dashed red)

**figure 4.** FWD

Typical reverse recovered energy loss as a function of gate resistor

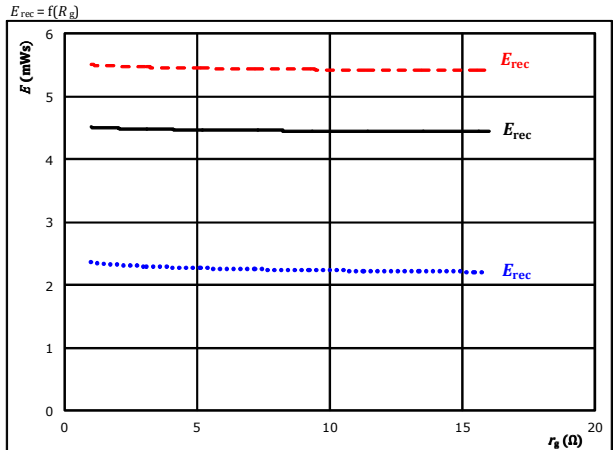

With an inductive load at  
 $V_{CE} = 600$  V  
 $V_{GE} = \pm 15$  V  
 $I_C = 80$  A

$T_j$ : 25 °C (dotted blue), 125 °C (solid black), 150 °C (dashed red)



## Half Bridge Switching Characteristics

**figure 5. IGBT**

Typical switching times as a function of collector current

$$t = f(I_C)$$

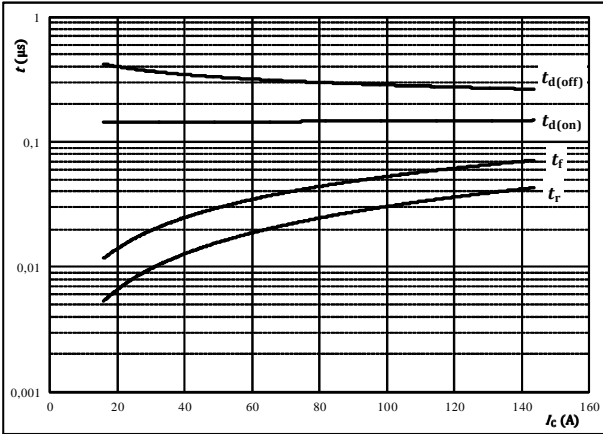

With an inductive load at

$T_j =$	150	°C
$V_{CE} =$	600	V
$V_{GE} =$	±15	V
$R_{gon} =$	4	Ω
$R_{goff} =$	4	Ω

**figure 6. IGBT**

Typical switching times as a function of gate resistor

$$t = f(R_g)$$

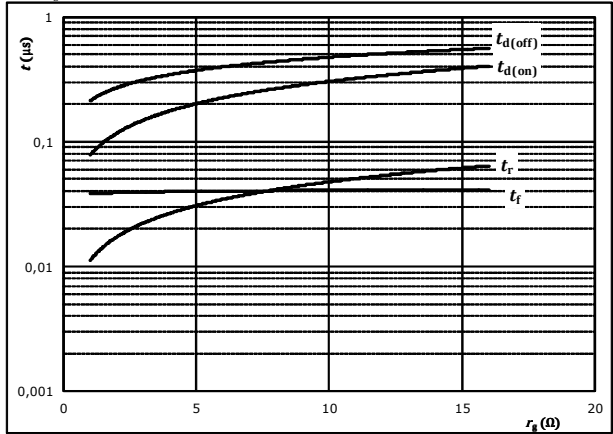

With an inductive load at

$T_j =$	150	°C
$V_{CE} =$	600	V
$V_{GE} =$	±15	V
$I_C =$	80	A

**figure 7. FWD**

Typical reverse recovery time as a function of collector current

$$t_{rr} = f(I_C)$$

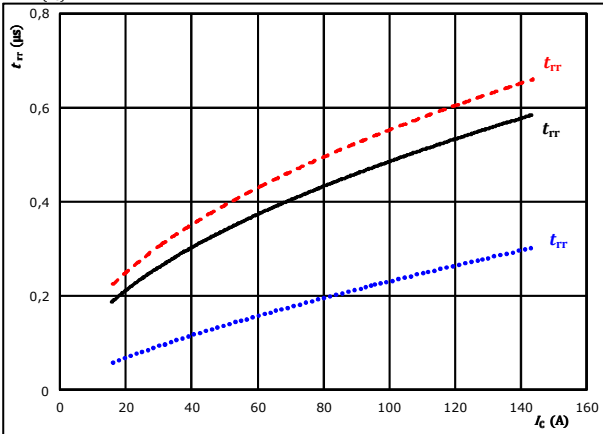

At

$V_{CE} =$	600	V
$V_{GE} =$	±15	V
$R_{gon} =$	4	Ω

$T_j:$	25 °C	.....
	125 °C	————
	150 °C	-----

**figure 8. FWD**

Typical reverse recovery time as a function of IGBT turn on gate resistor

$$t_{rr} = f(R_{gon})$$

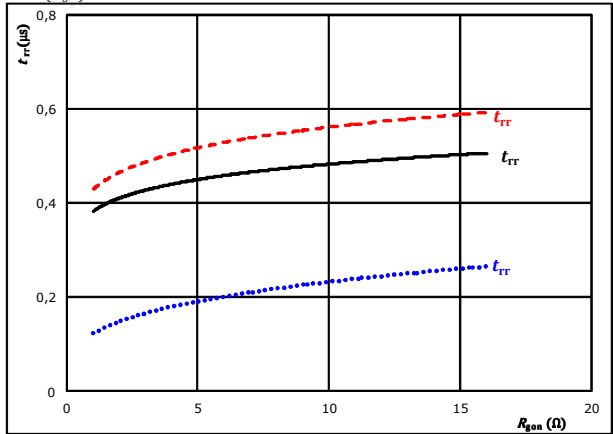

At

$V_{CE} =$	600	V
$V_{GE} =$	±15	V
$I_C =$	80	A

$T_j:$	25 °C	.....
	125 °C	————
	150 °C	-----



## Half Bridge Switching Characteristics

**figure 9.** FWD

Typical recovered charge as a function of collector current

$$Q_r = f(I_c)$$

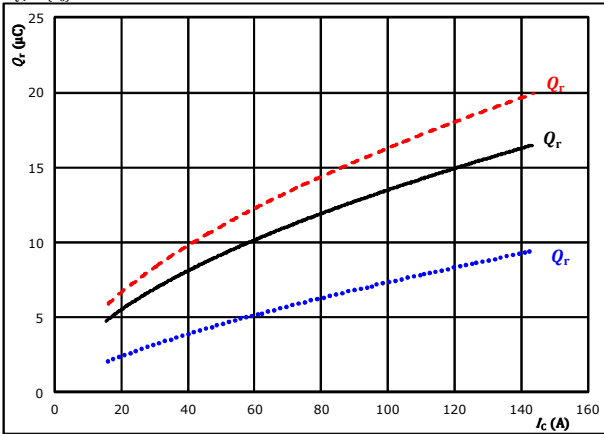

At  $V_{CE} = 600$  V  $T_j = 25$  °C (dotted blue)  
 $V_{GE} = \pm 15$  V  $T_j = 125$  °C (solid black)  
 $R_{gdn} = 4$  Ω  $T_j = 150$  °C (dashed red)

**figure 10.** FWD

Typical recovered charge as a function of IGBT turn on gate resistor

$$Q_r = f(R_{gdn})$$

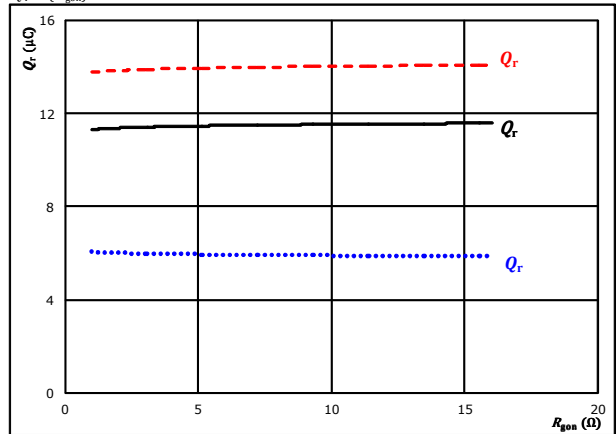

At  $V_{CE} = 600$  V  $T_j = 25$  °C (dotted blue)  
 $V_{GE} = \pm 15$  V  $T_j = 125$  °C (solid black)  
 $I_c = 80$  A  $T_j = 150$  °C (dashed red)

**figure 11.** FWD

Typical peak reverse recovery current current as a function of collector current

$$I_{RM} = f(I_c)$$

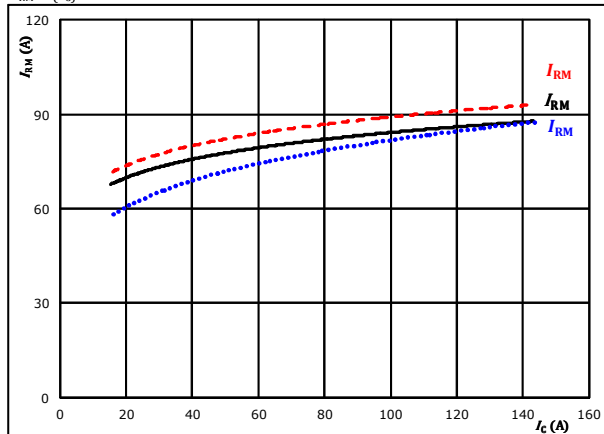

At  $V_{CE} = 600$  V  $T_j = 25$  °C (dotted blue)  
 $V_{GE} = \pm 15$  V  $T_j = 125$  °C (solid black)  
 $R_{gdn} = 4$  Ω  $T_j = 150$  °C (dashed red)

**figure 12.** FWD

Typical peak reverse recovery current current as a function of IGBT turn on gate resistor

$$I_{RM} = f(R_{gdn})$$

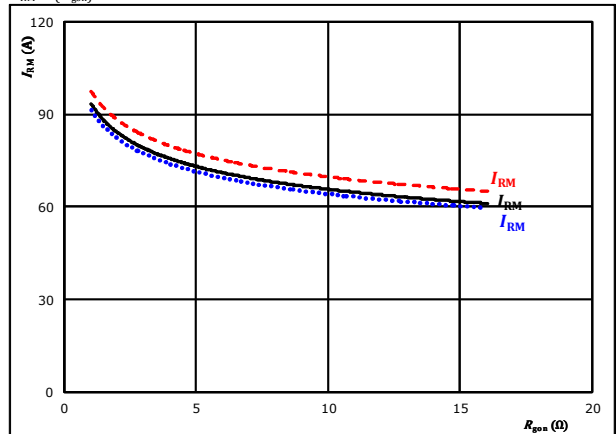

At  $V_{CE} = 600$  V  $T_j = 25$  °C (dotted blue)  
 $V_{GE} = \pm 15$  V  $T_j = 125$  °C (solid black)  
 $I_c = 80$  A  $T_j = 150$  °C (dashed red)



Vincotech

## Half Bridge Switching Characteristics

**figure 13.** FWD

Typical rate of fall of forward and reverse recovery current as a function of collector current  
 $di_f/dt, di_{rr}/dt = f(I_c)$

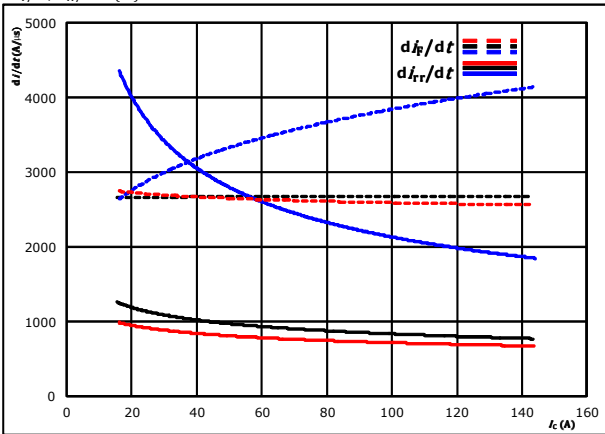

At  $V_{CE} = 600$  V  $T_j = 25$  °C .....  
 $V_{GE} = \pm 15$  V  $T_j = 125$  °C ———  
 $R_{gon} = 4$  Ω  $T_j = 150$  °C - - - - -

**figure 14.** FWD

Typical rate of fall of forward and reverse recovery current as a function of IGBT turn on gate resistor  
 $di_f/dt, di_{rr}/dt = f(R_{gon})$

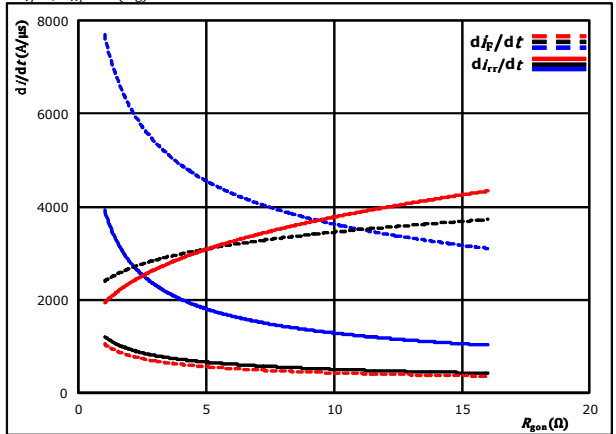

At  $V_{CE} = 600$  V  $T_j = 25$  °C .....  
 $V_{GE} = \pm 15$  V  $T_j = 125$  °C ———  
 $I_c = 80$  A  $T_j = 150$  °C - - - - -

**figure 15.** IGBT

Reverse bias safe operating area

$I_c = f(V_{ce})$

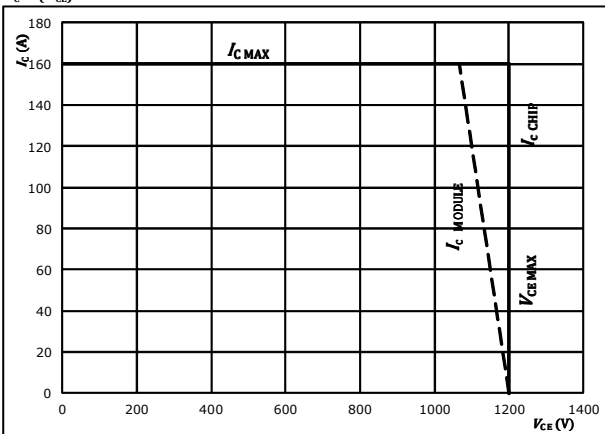

At  $T_j = 175$  °C  
 $R_{gon} = 4$  Ω  
 $R_{goff} = 4$  Ω



Vincotech

**10-FZ122PB080FV-M818F88**  
**10-PZ122PB080FV-M818F88Y**  
 datasheet

## Half Bridge Switching Definitions

### General conditions

$T_j$	=	150 °C
$R_{gon}$	=	4 $\Omega$
$R_{goff}$	=	4 $\Omega$

**figure 1.** IGBT

Turn-off Switching Waveforms & definition of  $t_{doff}$ ,  $t_{Eoff}$  ( $t_{Eoff}$  = integrating time for Eoff)

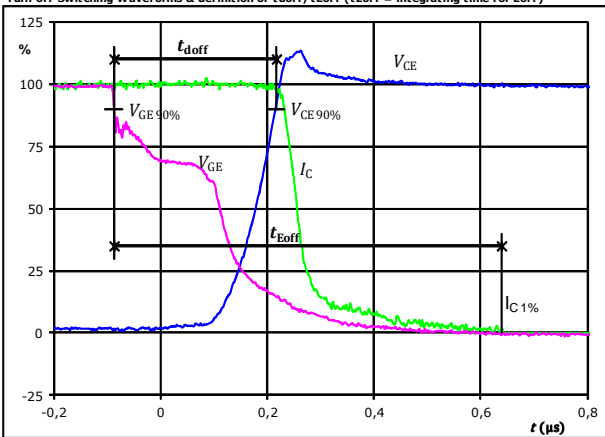

$V_{CE}(0\%) =$	-15	V
$V_{CE}(100\%) =$	15	V
$V_C(100\%) =$	600	V
$I_C(100\%) =$	81	A
$t_{doff} =$	0,302	$\mu$ s
$t_{Eoff} =$	0,726	$\mu$ s

**figure 2.** IGBT

Turn-on Switching Waveforms & definition of  $t_{don}$ ,  $t_{Eon}$  ( $t_{Eon}$  = integrating time for Eon)

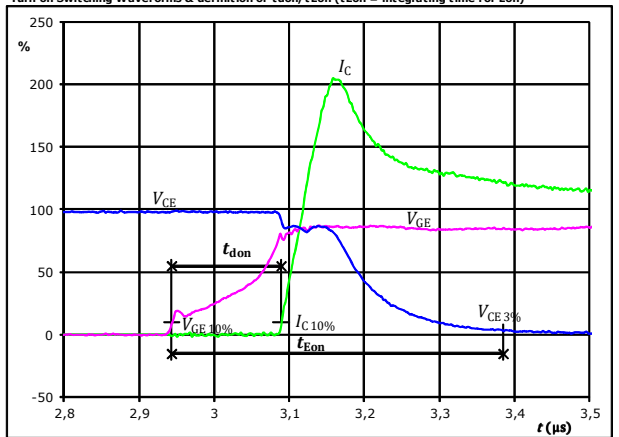

$V_{CE}(0\%) =$	-15	V
$V_{CE}(100\%) =$	15	V
$V_C(100\%) =$	600	V
$I_C(100\%) =$	81	A
$t_{don} =$	0,146	$\mu$ s
$t_{Eon} =$	0,442	$\mu$ s

**figure 3.** IGBT

Turn-off Switching Waveforms & definition of  $t_f$

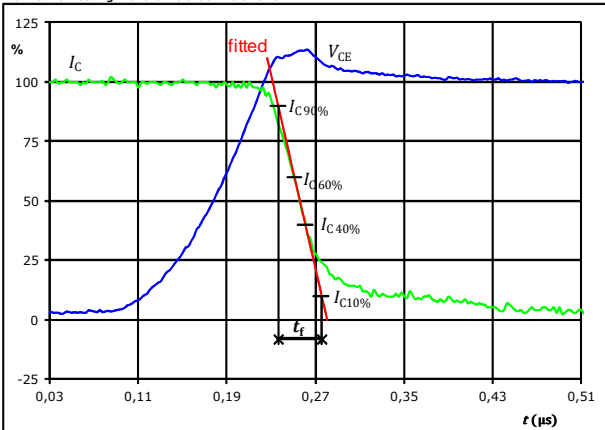

$V_C(100\%) =$	600	V
$I_C(100\%) =$	81	A
$t_f =$	0,040	$\mu$ s

**figure 4.** IGBT

Turn-on Switching Waveforms & definition of  $t_r$

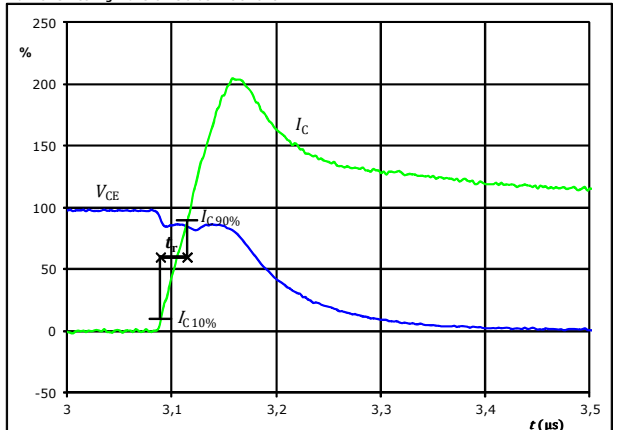

$V_C(100\%) =$	600	V
$I_C(100\%) =$	81	A
$t_r =$	0,026	$\mu$ s



Vincotech

## Half Bridge Switching Characteristics

**figure 5.** IGBT

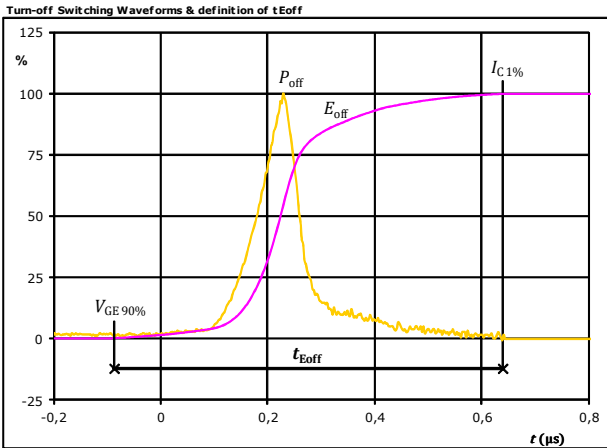

$P_{off}(100\%) = 48,41$  kW  
 $E_{off}(100\%) = 5,49$  mJ  
 $t_{Eoff} = 0,73$  μs

**figure 6.** IGBT

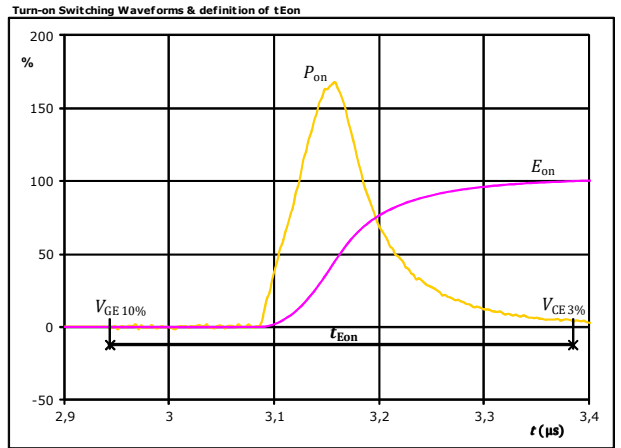

$P_{on}(100\%) = 48,41$  kW  
 $E_{on}(100\%) = 7,57$  mJ  
 $t_{Eon} = 0,44$  μs

**figure 7.** FWD

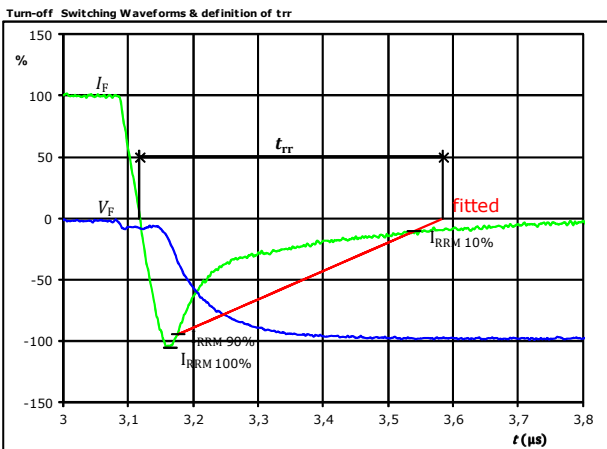

$V_F(100\%) = 600$  V  
 $I_F(100\%) = 81$  A  
 $I_{RRM}(100\%) = -85$  A  
 $t_{tr} = 0,482$  μs



## Half Bridge Switching Characteristics

**figure 8.** FWD

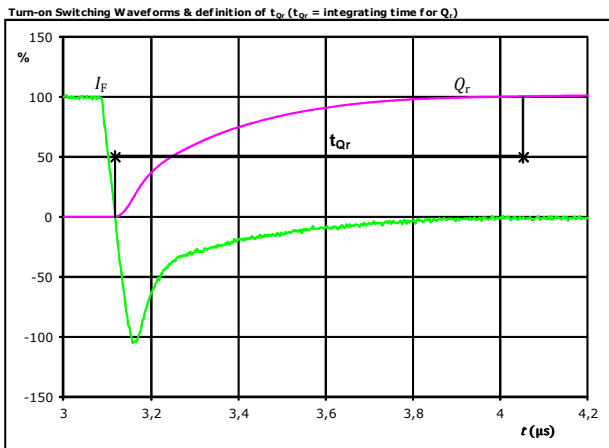

$I_F$ (100%) =	81	A
$Q_r$ (100%) =	13,89	$\mu\text{C}$
$t_{Qr}$ =	0,93	$\mu\text{s}$

**figure 9.** FWD

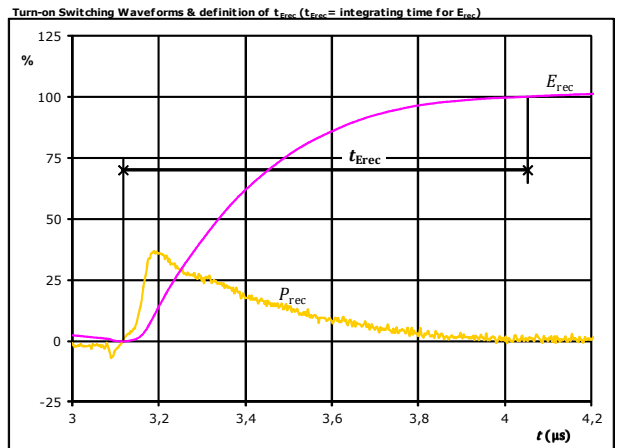

$P_{rec}$ (100%) =	48,41	kW
$E_{rec}$ (100%) =	5,47	mJ
$t_{Erec}$ =	0,93	$\mu\text{s}$



Vincotech

**10-FZ122PB080FV-M818F88**  
**10-PZ122PB080FV-M818F88Y**  
 datasheet

Ordering Code & Marking						
Version			Ordering Code			
without thermal paste 12mm housing with Solder Pin			10-FZ122PB080FV-M818F88			
without thermal paste 12mm housing with Press-fit			10-PZ122PB080FV-M818F88Y			
NN-NNNNNNNNNNNNNN TTTTUV WWYY UL VIN LLLLL SSSS						
Text	Name		Date code	UL & VIN	Lot	Serial
	NN-NNNNNNNNNNNNNN-TTTTUV		WWYY	UL VIN	LLLLL	SSSS
Datamatrix	Type&Ver	Lot number	Serial	Date code		
	TTTTTUV	LLLLL	SSSS	WWYY		

Pin table [mm]			
Pin	X	Y	Function
1	0	0	DC-
2	0	2,3	DC-
3	0	4,6	DC-
4	0	6,9	DC-
5	0	15,6	DC+
6	0	17,9	DC+
7	0	20,2	DC+
8	0	22,5	DC+
9	13,85	16,45	G12
10	16,75	16,45	S12
11	33,5	11,5	Ph
12	33,5	9,2	Ph
13	33,5	6,9	Ph
14	33,5	4,6	Ph
15	33,5	2,3	Ph
16	33,5	0	Ph
17	13,85	13,55	Ph
18	19,55	4,95	S11
19	19,55	7,85	G11
20	33,5	22,5	Therm1
21	26,1	22,5	Therm2

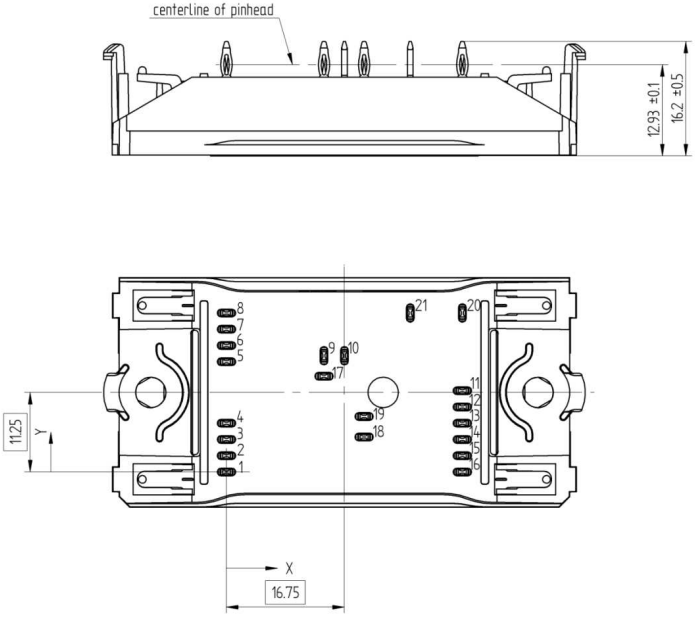

Tolerance of pinpositions: ±0,5mm at the end of pins  
 Dimension of coordinate axis is only offset without tolerance



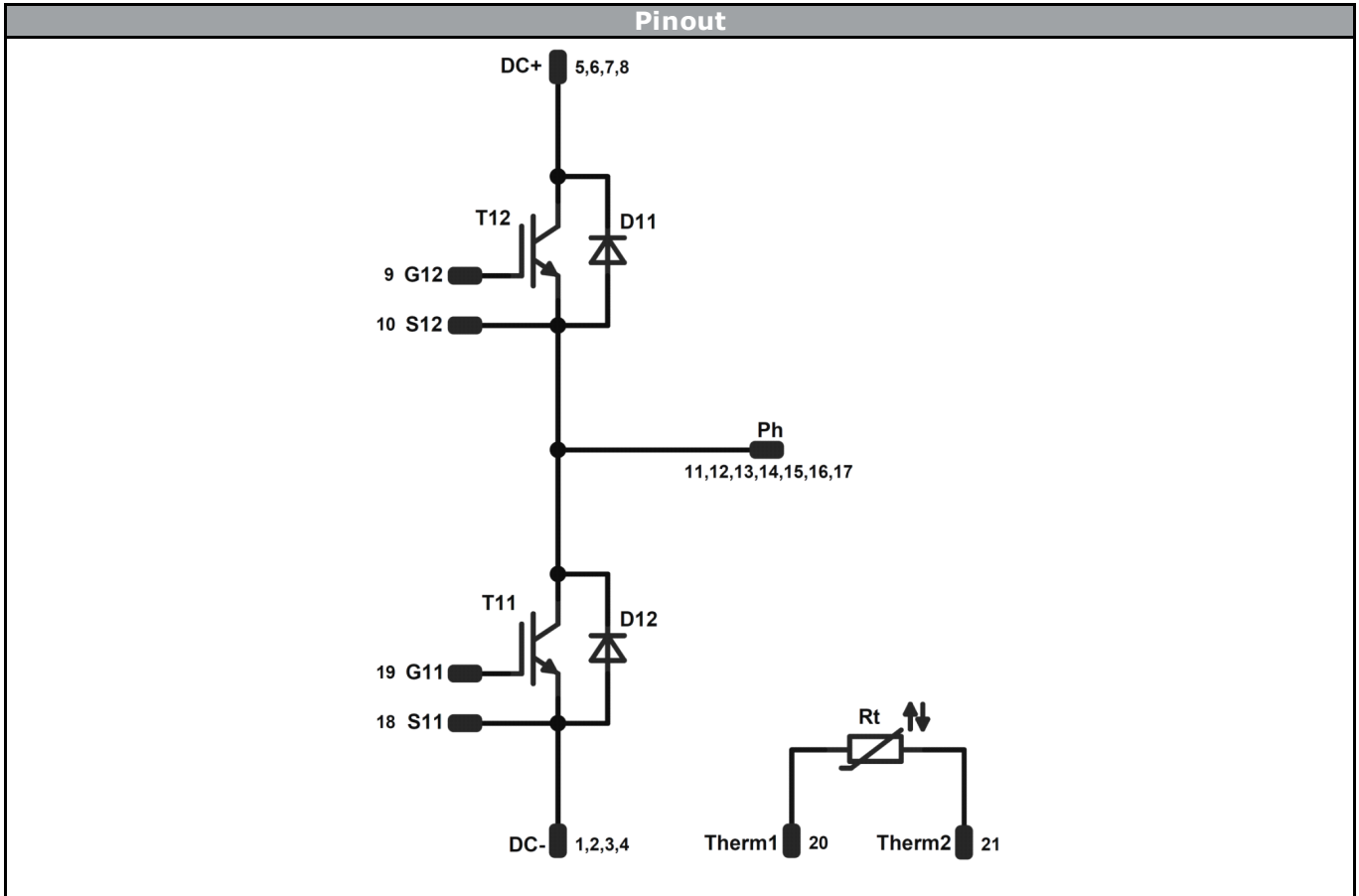

<b>Identification</b>					
<b>ID</b>	<b>Component</b>	<b>Voltage</b>	<b>Current</b>	<b>Function</b>	<b>Comment</b>
T11, T12	Switch	1200 V	80 A	Half Bridge Switch	
D11, D12	FWD	1200 V	75 A	Half Bridge Diode	
Rt	NTC			Thermistor	



Vincotech

10-FZ122PB080FV-M818F88  
10-PZ122PB080FV-M818F88Y  
datasheet

Packaging instruction			
Standard packaging quantity (SPQ) 135	>SPQ	Standard	<SPQ Sample

Handling instruction
Handling instructions for <i>flow 0</i> packages see vincotech.com website.

Package data
Package data for <i>flow 0</i> packages see vincotech.com website.

UL recognition and file number
This device is certified according to UL 1557 standard, UL file number E192116. For more information see vincotech.com website. 

Document No.:	Date:	Modification:	Pages
10-FZ122PB080FV-M818F88 -D1-14	26 Jul. 2016		

**DISCLAIMER**

The information, specifications, procedures, methods and recommendations herein (together "information") are presented by Vincotech to reader in good faith, are believed to be accurate and reliable, but may well be incomplete and/or not applicable to all conditions or situations that may exist or occur. Vincotech reserves the right to make any changes without further notice to any products to improve reliability, function or design. No representation, guarantee or warranty is made to reader as to the accuracy, reliability or completeness of said information or that the application or use of any of the same will avoid hazards, accidents, losses, damages or injury of any kind to persons or property or that the same will not infringe third parties rights or give desired results. It is reader's sole responsibility to test and determine the suitability of the information and the product for reader's intended use.

**LIFE SUPPORT POLICY**

Vincotech products are not authorised for use as critical components in life support devices or systems without the express written approval of Vincotech.

As used herein:

1. Life support devices or systems are devices or systems which, (a) are intended for surgical implant into the body, or (b) support or sustain life, or (c) whose failure to perform when properly used in accordance with instructions for use provided in labelling can be reasonably expected to result in significant injury to the user.
2. A critical component is any component of a life support device or system whose failure to perform can be reasonably expected to cause the failure of the life support device or system, or to affect its safety or effectiveness.