

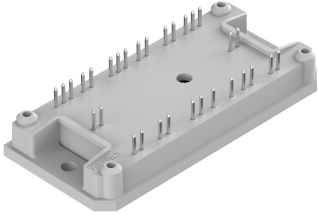

<i>flowPACK 1</i>		1200 V / 40 A	
Features <ul style="list-style-type: none">• High speed IGBT4• Tandem diodes for improved thermal performance• Integrated thermal sensor		flow 1 12 mm housing 	
Target applications <ul style="list-style-type: none">• Embedded Drives• Industrial Drives		Schematic 	
Types <ul style="list-style-type: none">• 10-FY126TA040SH-L827F68			

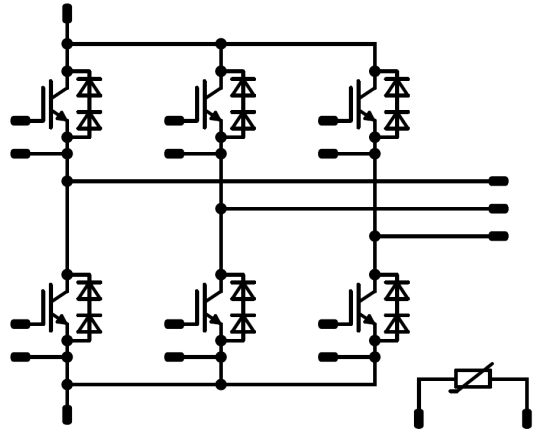

Vincotech

10-FY126TA040SH-L827F68
datasheet

Maximum Ratings

$T_j = 25\text{ °C}$, unless otherwise specified

Parameter	Symbol	Conditions	Value	Unit
Inverter Switch				
Collector-emitter voltage	V_{CES}		1200	V
Collector current (DC current)	I_C	$T_j = T_{jmax}$ $T_s = 80\text{ °C}$	44	A
Repetitive peak collector current	I_{CRM}	t_p limited by T_{jmax}	120	A
Total power dissipation	P_{tot}	$T_j = T_{jmax}$ $T_s = 80\text{ °C}$	111	W
Gate-emitter voltage	V_{GES}		± 20	V
Short circuit ratings	t_{SC}	$V_{GE} = 15\text{ V}$, $V_{CC} = 800\text{ V}$ $T_j = 150\text{ °C}$	10	μs
Maximum junction temperature	T_{jmax}		175	$^{\circ}\text{C}$

Inverter Diode

Peak repetitive reverse voltage	V_{RRM}		1300	V
Forward current (DC current)	I_F	$T_j = T_{jmax}$ $T_s = 80\text{ °C}$	33	A
Repetitive peak forward current	I_{FRM}	t_p limited by T_{jmax}	80	A
Total power dissipation	P_{tot}	$T_j = T_{jmax}$ $T_s = 80\text{ °C}$	88	W
Maximum junction temperature	T_{jmax}		175	$^{\circ}\text{C}$

Module Properties

Thermal Properties

Storage temperature	T_{stg}		-40...+125	$^{\circ}\text{C}$
Operation temperature under switching condition	T_{jop}		-40...+($T_{jmax} - 25$)	$^{\circ}\text{C}$

Isolation Properties

Isolation voltage	V_{isol}	DC Test Voltage* $t_p = 2\text{ s}$	6000	V
Isolation voltage	V'_{isol}	AC Voltage $t_p = 1\text{ min}$	2500	V
Creepage distance			>12,7	mm
Clearance			7,81	mm
Comparative Tracking Index	CTI		≥ 200	

*100 % tested in production



Vincotech

Characteristic Values

Parameter	Symbol	Conditions					Values			Unit
		V_{GS} [V]	V_{GE} [V]	V_{DS} [V]	V_F [V]	I_C [A] I_D [A] I_F [A]	T_j [°C]	Min	Typ	

Inverter Switch

Static

Gate-emitter threshold voltage	$V_{GE(th)}$	$V_{CE} = V_{GE}$				0,0015	25	5,3	5,8	6,3	V
Collector-emitter saturation voltage	$V_{CE(sat)}$		15		40		25 125 150	1,78	1,94 2,23 2,32	2,42 ⁽¹⁾	V
Collector-emitter cut-off current	I_{CES}		0	1200			25			5	µA
Gate-emitter leakage current	I_{GES}		20	0			25			120	nA
Internal gate resistance	r_g								None		Ω
Input capacitance	C_{ies}								2330		pF
Output capacitance	C_{oes}	$f = 1$ Mhz	0	25			25		150		pF
Reverse transfer capacitance	C_{res}								130		pF
Gate charge	Q_g	$V_{CC} = 960$ V	15		40		25		185		nC

Thermal

Thermal resistance junction to sink ⁽²⁾	$R_{th(j-s)}$	$\lambda_{paste} = 3,4$ W/mK (PSX)							0,86		K/W
--	---------------	---------------------------------------	--	--	--	--	--	--	------	--	-----

Dynamic

Turn-on delay time	$t_{d(on)}$						25 125 150		62,4 63,2 64,4		ns
Rise time	t_r	$R_{gon} = 8$ Ω $R_{goff} = 8$ Ω					25 125 150		12,8 15 15,6		ns
Turn-off delay time	$t_{d(off)}$		±15	600	40		25 125 150		164,6 216,8 228,8		ns
Fall time	t_f						25 125 150		54,58 63,42 78,56		ns
Turn-on energy (per pulse)	E_{on}	$Q_{tFWD} = 1,44$ µC $Q_{tFWD} = 2,66$ µC $Q_{tFWD} = 2,93$ µC					25 125 150		1,17 1,71 1,84		mWs
Turn-off energy (per pulse)	E_{off}						25 125 150		1,46 2,33 2,54		mWs



Vincotech

10-FY126TA040SH-L827F68
datasheet

Characteristic Values

Parameter	Symbol	Conditions					Values			Unit
		V_{GE} [V] V_{GS} [V]	V_{CE} [V] V_{DS} [V] V_F [V]	I_C [A] I_D [A] I_F [A]	T_j [°C]	Min	Typ	Max		

Inverter Diode

Static

Forward voltage	V_F				40	25 125 150		3,06 2,92 2,85	3,84 ⁽¹⁾	V
Reverse leakage current	I_R	$V_r = 1300$ V				25			2,1	μA

Thermal

Thermal resistance junction to sink ⁽²⁾	$R_{th(j-s)}$	$\lambda_{paste} = 3,4$ W/mK (PSX)						1,08		K/W
--	---------------	---------------------------------------	--	--	--	--	--	------	--	-----

Dynamic

Peak recovery current	I_{RRM}					25 125 150		41,24 47,85 50,02		A
Reverse recovery time	t_{rr}					25 125 150		73,95 125,62 133,03		ns
Recovered charge	Q_r	$di/dt=3039$ A/μs $di/dt=3062$ A/μs $di/dt=2575$ A/μs	±15	600	40	25 125 150		1,44 2,66 2,93		μC
Reverse recovered energy	E_{rec}					25 125 150		0,5 0,965 1,06		mWs
Peak rate of fall of recovery current	$(di_r/dt)_{max}$					25 125 150		2993 705,12 751,29		A/μs



Vincotech

Characteristic Values

Parameter	Symbol	Conditions					Values			Unit	
		V_{GS} [V]	V_{GE} [V]	V_{DS} [V]	V_{CE} [V]	V_F [V]	I_D [A]	I_C [A]	I_F [A]		T_j [°C]

Thermistor

Static

Rated resistance	R					25		22		kΩ
Deviation of R_{100}	$A_{R/R}$	$R_{100} = 1484 \Omega$				100	-5		5	%
Power dissipation	P							5		mW
Power dissipation constant	d					25		1,5		mW/K
B-value	$B_{(25/50)}$	Tol. $\pm 1 \%$						3962		K
B-value	$B_{(25/100)}$	Tol. $\pm 1 \%$						4000		K
Vincotech Thermistor Reference									I	

⁽¹⁾ Value at chip level

⁽²⁾ Only valid with pre-applied Vincotech thermal interface material.



Inverter Switch Characteristics

figure 1. IGBT

Typical output characteristics

$$I_C = f(V_{CE})$$

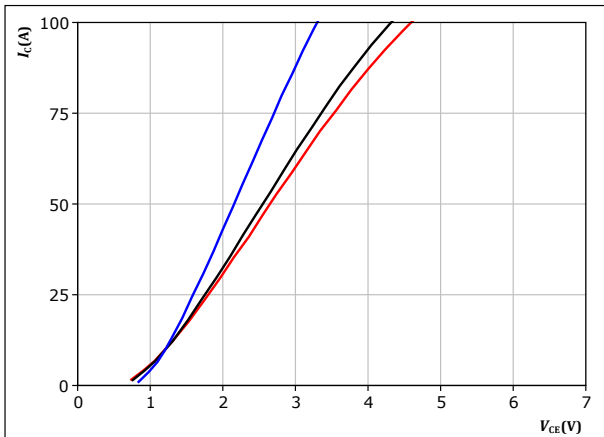

$t_p = 250 \mu\text{s}$
 $V_{GE} = 15 \text{ V}$

T_j :
— 25 °C
— 125 °C
— 150 °C

figure 2. IGBT

Typical output characteristics

$$I_C = f(V_{CE})$$

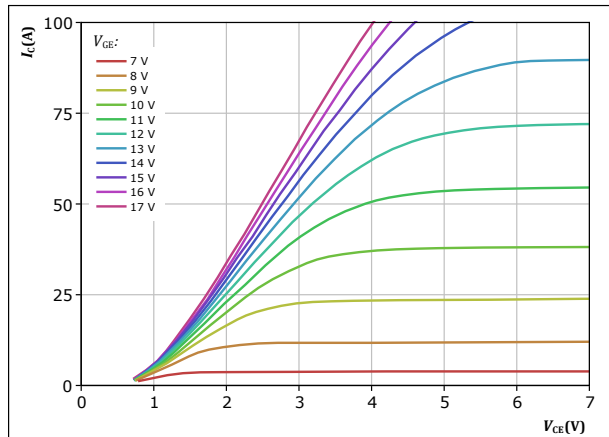

$t_p = 250 \mu\text{s}$
 $T_j = 150 \text{ °C}$
 V_{GE} from 7 V to 17 V in steps of 1 V

figure 3. IGBT

Typical transfer characteristics

$$I_C = f(V_{GE})$$

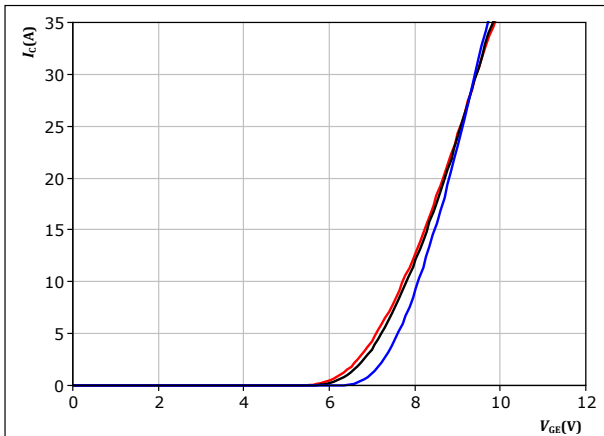

$t_p = 250 \mu\text{s}$
 $V_{CE} = 10 \text{ V}$

T_j :
— 25 °C
— 125 °C
— 150 °C

figure 4. IGBT

Transient thermal impedance as a function of pulse width

$$Z_{th(j-s)} = f(t_p)$$

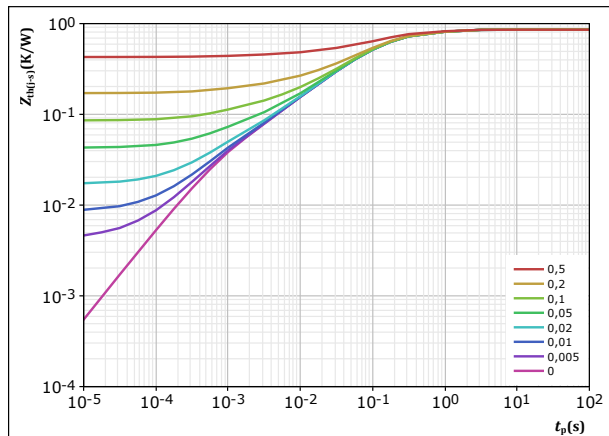

$D = t_p / T$
 $R_{th(j-s)} = 0,856 \text{ K/W}$

IGBT thermal model values

R (K/W)	τ (s)
1,40E-01	8,31E-01
4,53E-01	1,26E-01
1,58E-01	3,84E-02
7,23E-02	8,41E-03
3,25E-02	8,46E-04



Vincotech

Inverter Switch Characteristics

figure 5. IGBT

Safe operating area

$$I_C = f(V_{CE})$$

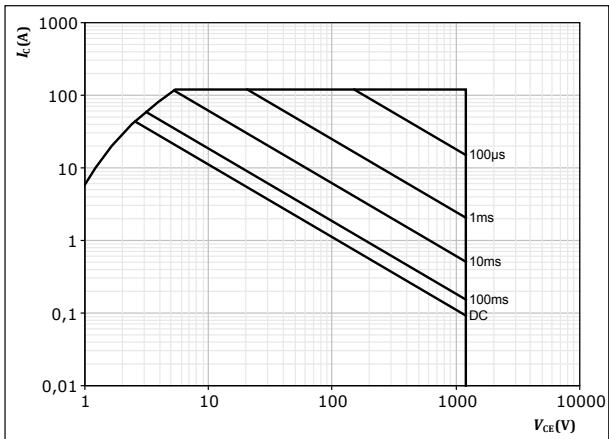

$D =$ single pulse

$T_s = 80$ °C

$V_{GE} = 15$ V

$T_j = T_{jmax}$



Inverter Diode Characteristics

figure 6. FWD

Typical forward characteristics

$$I_F = f(V_F)$$

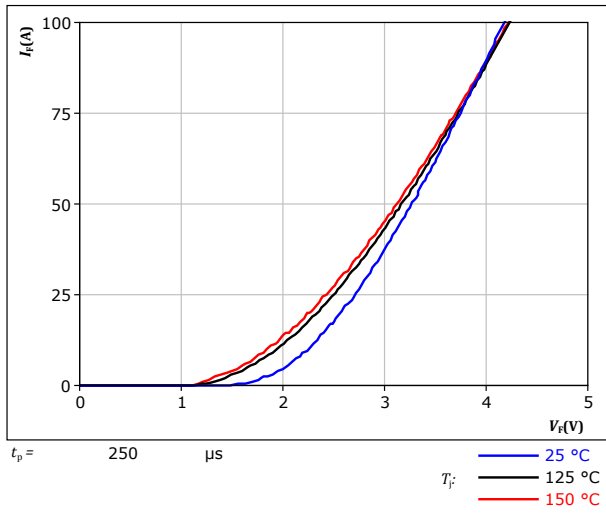
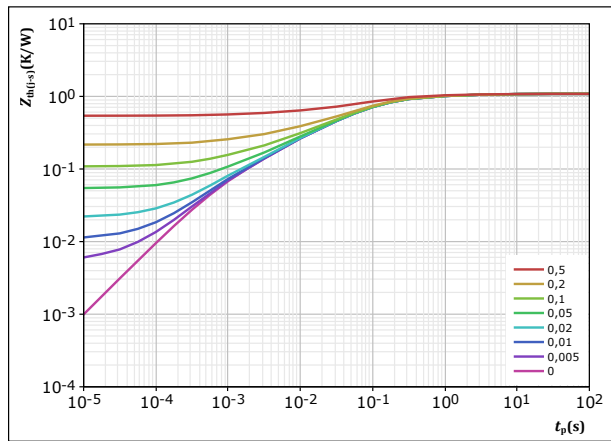

figure 7. FWD

Transient thermal impedance as a function of pulse width

$$Z_{th(j-s)} = f(t_p)$$



$D = \frac{t_p}{T}$
 $R_{th(j-s)} = 1,084 \text{ K/W}$
 FWD thermal model values

R (K/W)	τ (s)
4,47E-02	5,44E+00
1,14E-01	8,25E-01
4,25E-01	1,38E-01
3,22E-01	3,58E-02
1,30E-01	5,79E-03
4,74E-02	7,29E-04



Thermistor Characteristics

figure 8. Thermistor

Typical NTC characteristic as function of temperature

$$R_T = f(T)$$

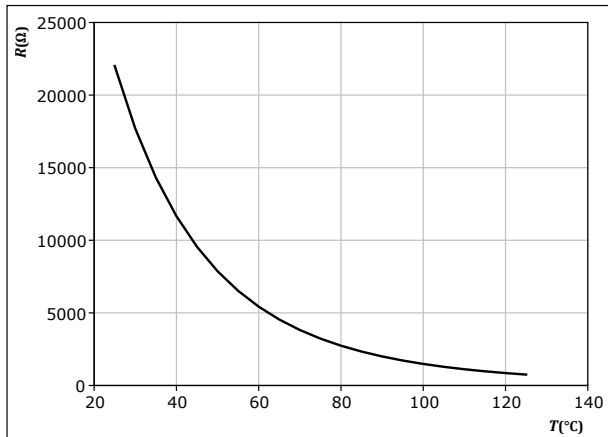



Inverter Switching Characteristics

figure 9. IGBT

Typical switching energy losses as a function of collector current
 $E = f(I_c)$

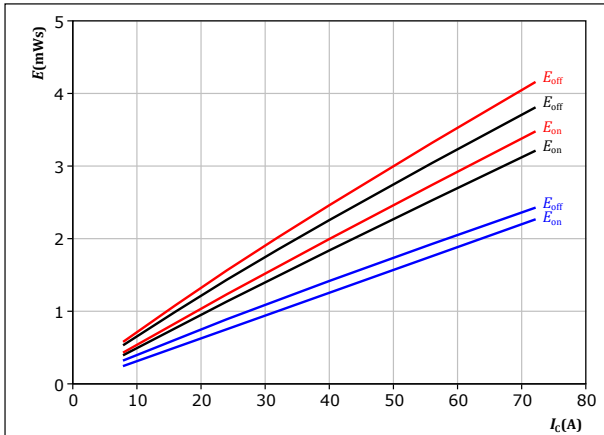

With an inductive load at

$V_{CE} =$	600	V	$T_j:$	— 25 °C
$V_{GE} =$	±15	V		— 125 °C
$R_{g(on)} =$	8	Ω		— 150 °C
$R_{g(off)} =$	8	Ω		

figure 10. IGBT

Typical switching energy losses as a function of gate resistor
 $E = f(R_g)$

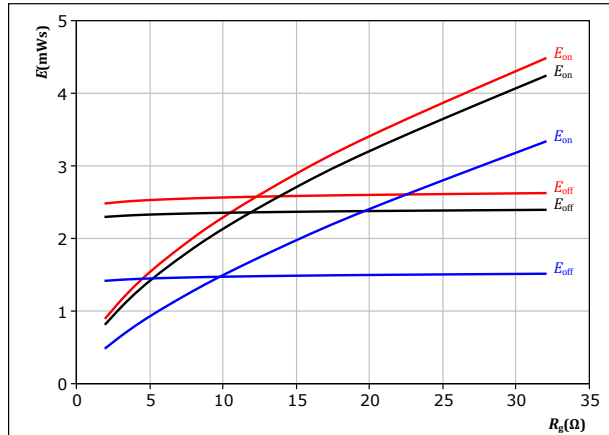

With an inductive load at

$V_{CE} =$	600	V	$T_j:$	— 25 °C
$V_{GE} =$	±15	V		— 125 °C
$I_c =$	40	A		— 150 °C

figure 11. FWD

Typical reverse recovered energy loss as a function of collector current
 $E_{rec} = f(I_c)$

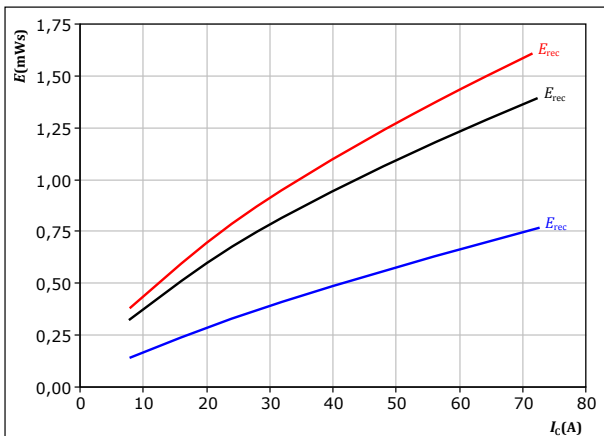

With an inductive load at

$V_{CE} =$	600	V	$T_j:$	— 25 °C
$V_{GE} =$	±15	V		— 125 °C
$R_{g(on)} =$	8	Ω		— 150 °C

figure 12. FWD

Typical reverse recovered energy loss as a function of gate resistor
 $E_{rec} = f(R_g)$

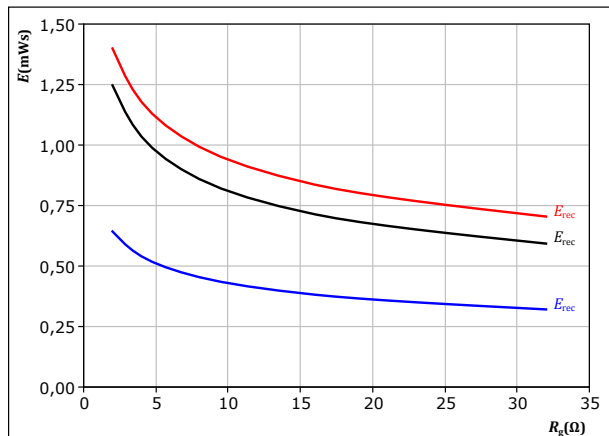

With an inductive load at

$V_{CE} =$	600	V	$T_j:$	— 25 °C
$V_{GE} =$	±15	V		— 125 °C
$I_c =$	40	A		— 150 °C



Inverter Switching Characteristics

figure 13. IGBT

Typical switching times as a function of collector current
 $t = f(I_c)$

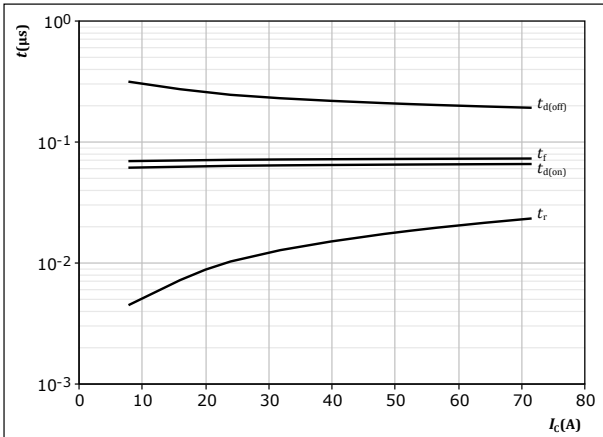

With an inductive load at
 $T_j = 150 \text{ }^\circ\text{C}$
 $V_{CE} = 600 \text{ V}$
 $V_{GE} = \pm 15 \text{ V}$
 $R_{gon} = 8 \text{ } \Omega$
 $R_{goff} = 8 \text{ } \Omega$

figure 14. IGBT

Typical switching times as a function of gate resistor
 $t = f(R_g)$

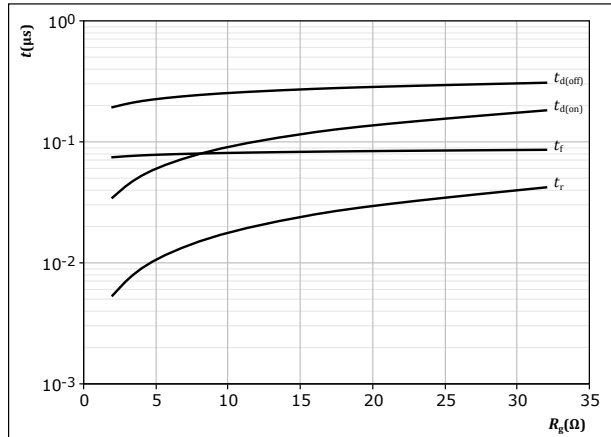

With an inductive load at
 $T_j = 150 \text{ }^\circ\text{C}$
 $V_{CE} = 600 \text{ V}$
 $V_{GE} = \pm 15 \text{ V}$
 $I_c = 40 \text{ A}$

figure 15. FWD

Typical reverse recovery time as a function of collector current
 $t_{rr} = f(I_c)$

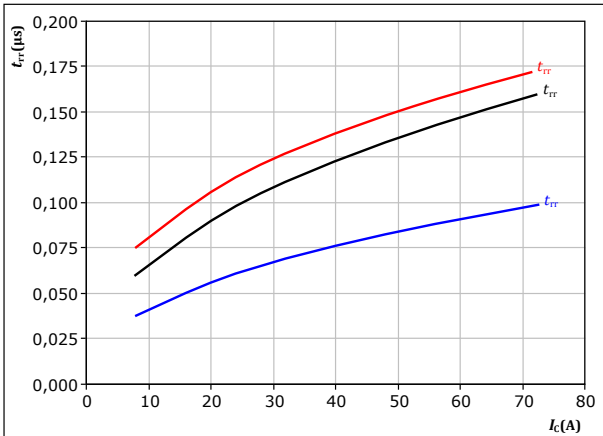

With an inductive load at
 $V_{CE} = 600 \text{ V}$
 $V_{GE} = \pm 15 \text{ V}$
 $R_{gon} = 8 \text{ } \Omega$
 $T_j:$ — 25 °C
 — 125 °C
 — 150 °C

figure 16. FWD

Typical reverse recovery time as a function of IGBT turn on gate resistor
 $t_{rr} = f(R_{gon})$

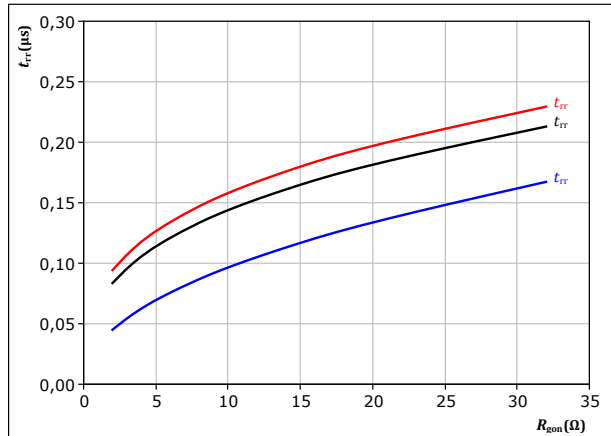

With an inductive load at
 $V_{CE} = 600 \text{ V}$
 $V_{GE} = \pm 15 \text{ V}$
 $I_c = 40 \text{ A}$
 $T_j:$ — 25 °C
 — 125 °C
 — 150 °C



Inverter Switching Characteristics

figure 17. FWD

Typical recovered charge as a function of collector current

$$Q_r = f(I_c)$$

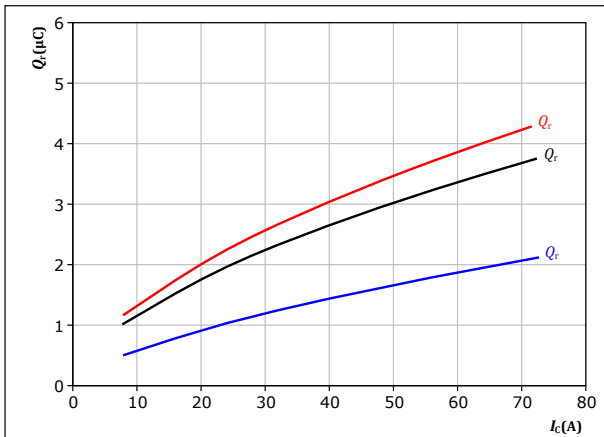

With an inductive load at

$V_{CE} = 600 \text{ V}$
 $V_{GE} = \pm 15 \text{ V}$
 $R_{gon} = 8 \ \Omega$

T_j : — 25 °C
— 125 °C
— 150 °C

figure 18. FWD

Typical recovered charge as a function of turn on gate resistor

$$Q_r = f(R_{gon})$$

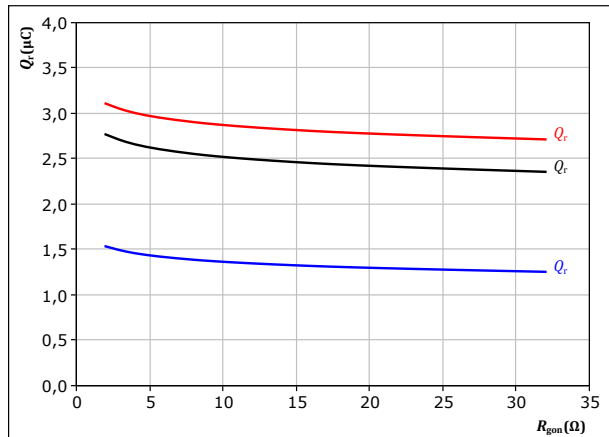

With an inductive load at

$V_{CE} = 600 \text{ V}$
 $V_{GE} = \pm 15 \text{ V}$
 $I_c = 40 \text{ A}$

T_j : — 25 °C
— 125 °C
— 150 °C

figure 19. FWD

Typical peak reverse recovery current as a function of collector current

$$I_{RM} = f(I_c)$$

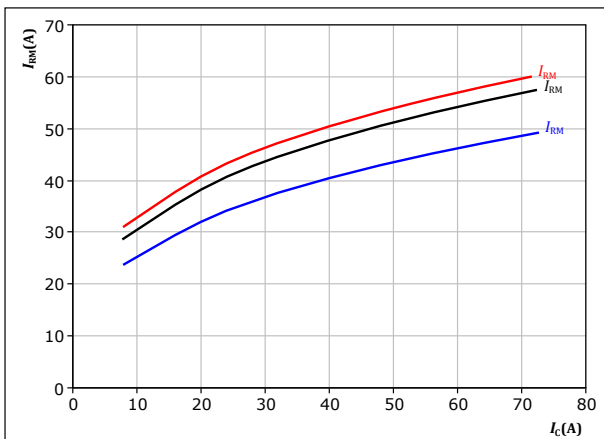

With an inductive load at

$V_{CE} = 600 \text{ V}$
 $V_{GE} = \pm 15 \text{ V}$
 $R_{gon} = 8 \ \Omega$

T_j : — 25 °C
— 125 °C
— 150 °C

figure 20. FWD

Typical peak reverse recovery current as a function of turn on gate resistor

$$I_{RM} = f(R_{gon})$$

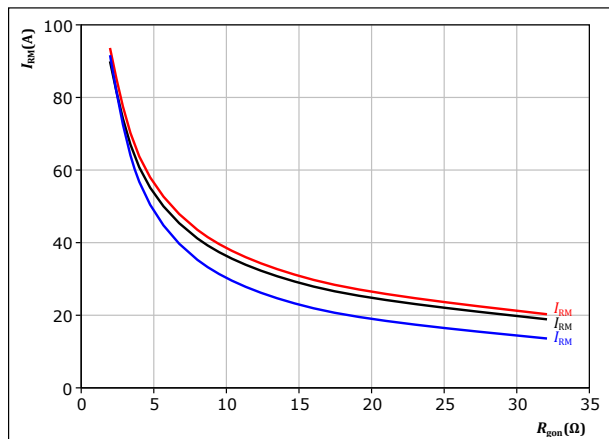

With an inductive load at

$V_{CE} = 600 \text{ V}$
 $V_{GE} = \pm 15 \text{ V}$
 $I_c = 40 \text{ A}$

T_j : — 25 °C
— 125 °C
— 150 °C



Inverter Switching Characteristics

figure 21. FWD

Typical rate of fall of forward and reverse recovery current as a function of collector current
 $di_f/dt, di_{rr}/dt = f(I_C)$

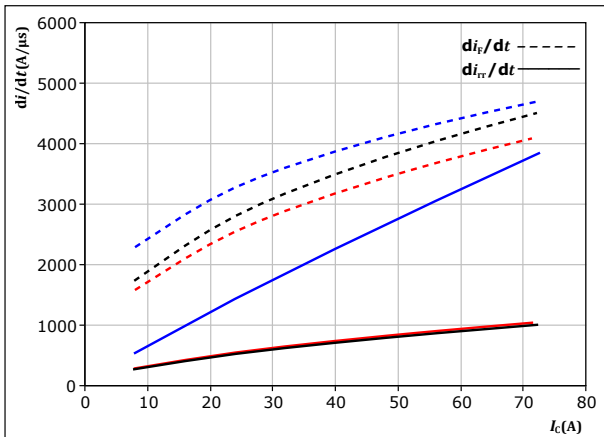

With an inductive load at

$V_{CE} = 600 \text{ V}$	$T_j = 25 \text{ }^\circ\text{C}$
$V_{GE} = \pm 15 \text{ V}$	$T_j = 125 \text{ }^\circ\text{C}$
$R_{gon} = 8 \text{ } \Omega$	$T_j = 150 \text{ }^\circ\text{C}$

figure 22. FWD

Typical rate of fall of forward and reverse recovery current as a function of turn on gate resistor
 $di_f/dt, di_{rr}/dt = f(R_{gon})$

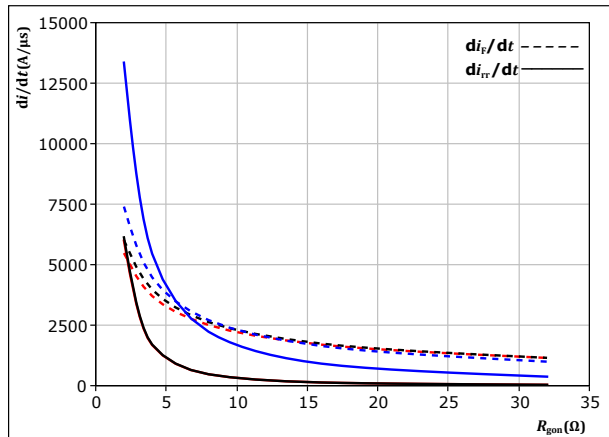

With an inductive load at

$V_{CE} = 600 \text{ V}$	$T_j = 25 \text{ }^\circ\text{C}$
$V_{GE} = \pm 15 \text{ V}$	$T_j = 125 \text{ }^\circ\text{C}$
$I_C = 40 \text{ A}$	$T_j = 150 \text{ }^\circ\text{C}$

figure 23. IGBT

Reverse bias safe operating area

$I_C = f(V_{CE})$

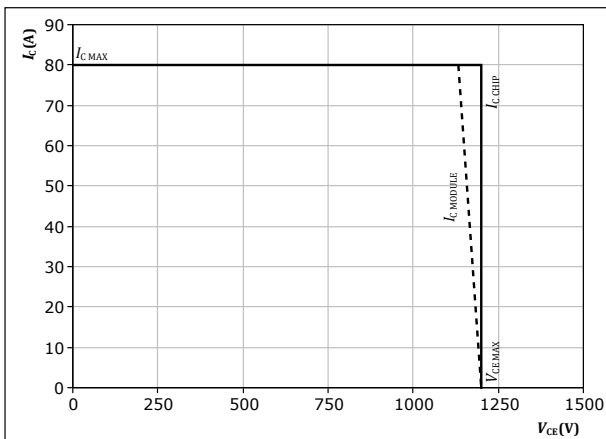

At $T_j = 150 \text{ }^\circ\text{C}$
 $R_{gon} = 8 \text{ } \Omega$
 $R_{goff} = 8 \text{ } \Omega$



Inverter Switching Definitions

figure 24. IGBT

Turn-off Switching Waveforms & definition of t_{doff} , t_{Eoff} (t_{Eoff} = integrating time for E_{off})

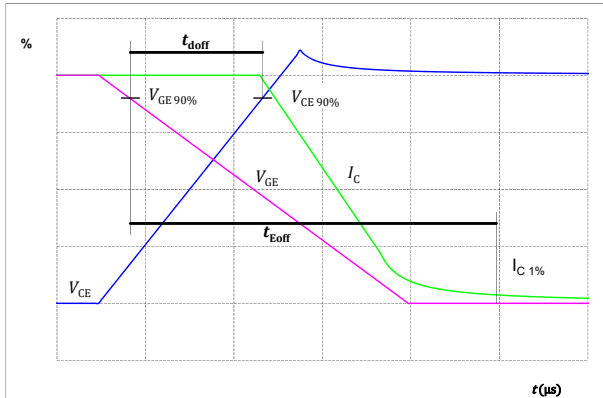

figure 25. IGBT

Turn-on Switching Waveforms & definition of t_{don} , t_{Eon} (t_{Eon} = integrating time for E_{on})

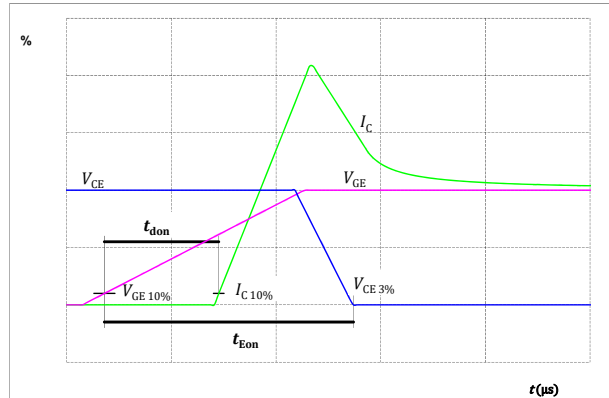

figure 26. IGBT

Turn-off Switching Waveforms & definition of t_f

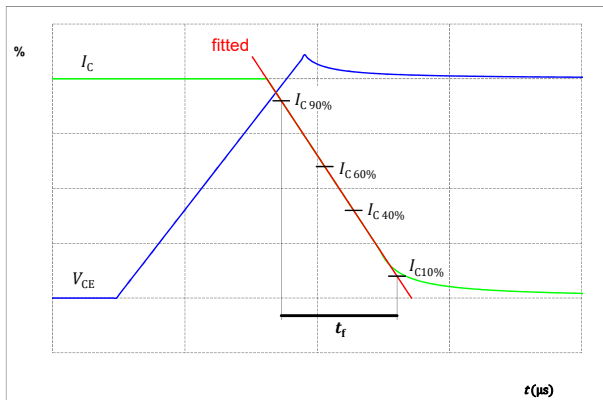
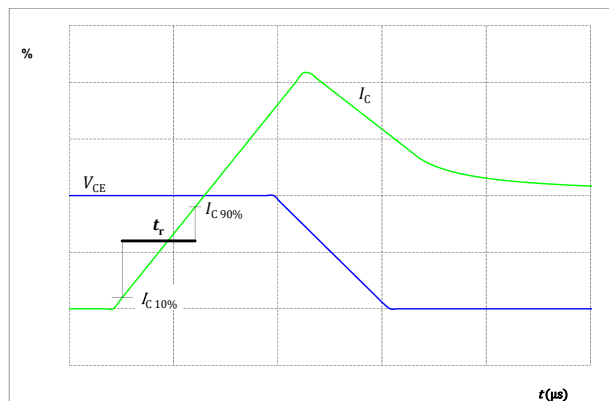

figure 27. IGBT

Turn-on Switching Waveforms & definition of t_r





Inverter Switching Definitions

figure 28. FWD

Turn-off Switching Waveforms & definition of t_{rr}



figure 29. FWD

Turn-on Switching Waveforms & definition of t_{Qr} (t_{Qr} = integrating time for Q_r)

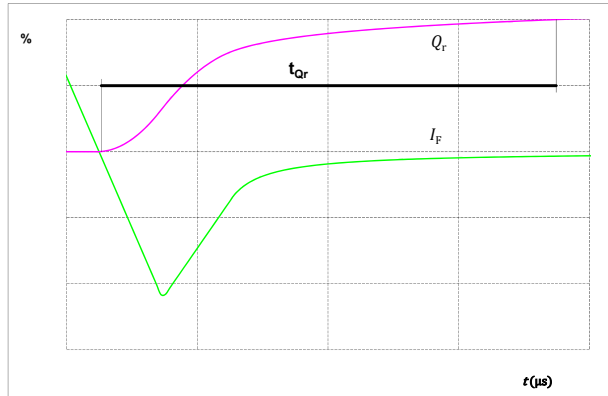



Vincotech

10-FY126TA040SH-L827F68
datasheet

Ordering Code	
Version	Ordering Code
Without thermal paste	10-FY126TA040SH-L827F68
With thermal paste	10-FY126TA040SH-L827F68-/3/

Marking						
	Text	Name NN-NNNNNNNNNNNNNN- TTTTTVV	Date code WWYY	UL & VIN UL VIN	Lot LLLLL	Serial SSSS
	Datamatrix	Type&Ver TTTTTTTV	Lot number LLLLL	Serial SSSS	Date code WWYY	

Pin table [mm]			
Pin	X	Y	Function
1	52,6	0	DC-123
2	49,9	0	DC-123
3	42,65	0	G15
4	39,65	0	S15
5	35,15	0	Therm1
6	28,4	0	Therm2
7	24	0	G13
8	21	0	S13
9	12,2	0	G11
10	9,2	0	S11
11	2,7	0	DC-123
12	0	0	DC-123
13	0	14,65	DC+123
14	2,7	14,65	DC+123
15	0	28,6	Ph1
16	2,7	28,6	Ph1
17	5,4	28,6	Ph1
18	9,6	28,6	S12
19	12,6	28,6	G12
20	19,6	28,6	Ph2
21	22,3	28,6	Ph2
22	25	28,6	Ph2
23	29,7	28,6	S14
24	32,7	28,6	G14
25	39,7	28,6	S16
26	42,7	28,6	G16
27	47,2	28,6	Ph3
28	49,9	28,6	Ph3
29	52,6	28,6	Ph3
30	52,6	14,65	DC+123
31	49,9	14,65	DC+123

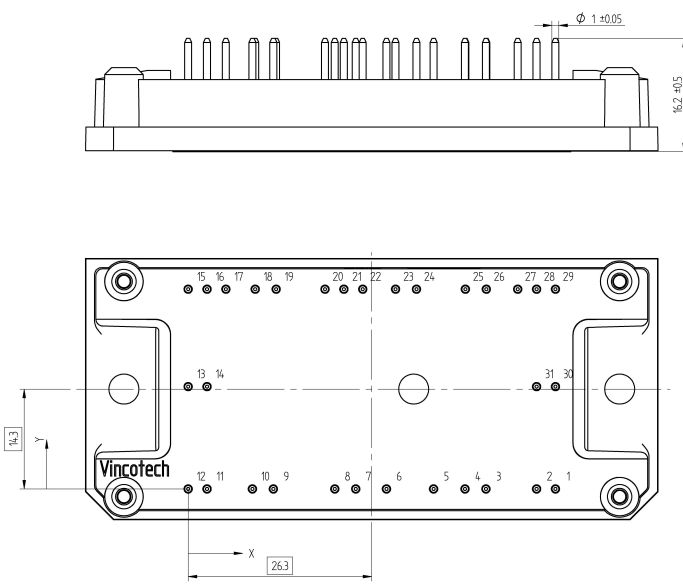

Tolerance of pinpositions: $\pm 0,5\text{mm}$ at the end of pins
Dimension of coordinate axis is only offset without tolerance



Vincotech

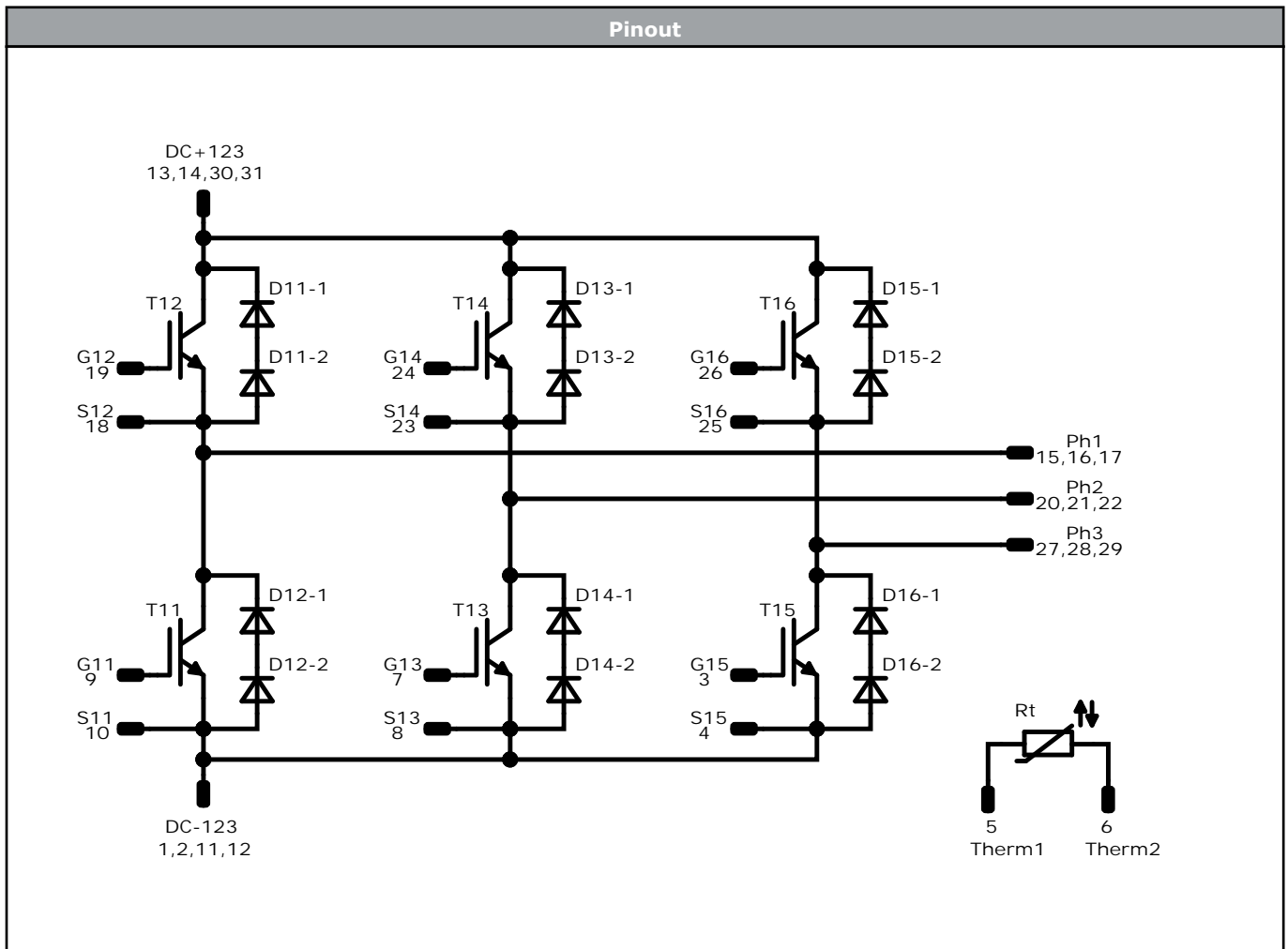

Identification					
ID	Component	Voltage	Current	Function	Comment
T11, T12, T13, T14, T15, T16	IGBT	1200 V	40 A	Inverter Switch	
D11, D12, D13, D14, D15, D16	FWD	1300 V	40 A	Inverter Diode	
Rt	NTC			Thermistor	



Packaging instruction				
Standard packaging quantity (SPQ) 100	>SPQ	Standard	<SPQ	Sample

Handling instruction
Handling instructions for <i>flow 1</i> packages see vincotech.com website.

Package data
Package data for <i>flow 1</i> packages see vincotech.com website.

Vincotech thermistor reference
See Vincotech thermistor reference table at vincotech.com website.

UL recognition and file number
This device is certified according to UL 1557 standard, UL file number E192116. For more information see vincotech.com website. 

Document No.:	Date:	Modification:	Pages
10-FY126TA040SH-L827F68-D1-14	8 Apr. 2021	Initial Release	

DISCLAIMER

The information, specifications, procedures, methods and recommendations herein (together "information") are presented by Vincotech to reader in good faith, are believed to be accurate and reliable, but may well be incomplete and/or not applicable to all conditions or situations that may exist or occur. Vincotech reserves the right to make any changes without further notice to any products to improve reliability, function or design. No representation, guarantee or warranty is made to reader as to the accuracy, reliability or completeness of said information or that the application or use of any of the same will avoid hazards, accidents, losses, damages or injury of any kind to persons or property or that the same will not infringe third parties rights or give desired results. It is reader's sole responsibility to test and determine the suitability of the information and the product for reader's intended use.

LIFE SUPPORT POLICY

Vincotech products are not authorised for use as critical components in life support devices or systems without the express written approval of Vincotech.

As used herein:

1. Life support devices or systems are devices or systems which, (a) are intended for surgical implant into the body, or (b) support or sustain life, or (c) whose failure to perform when properly used in accordance with instructions for use provided in labelling can be reasonably expected to result in significant injury to the user.
2. A critical component is any component of a life support device or system whose failure to perform can be reasonably expected to cause the failure of the life support device or system, or to affect its safety or effectiveness.