



**flowPACK 1 H6.5**

**650 V / 75 A**

**Features**

- Innovative H6.5 Topology
- Fast IGBTs and Diodes
- NTC

**Target applications**

- Energy Storage Systems
- Solar Inverters

**Types**

- 10-FY07HVA075RG-L985F88

**flow 1 12 mm housing**

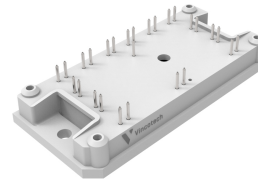

**Schematic**

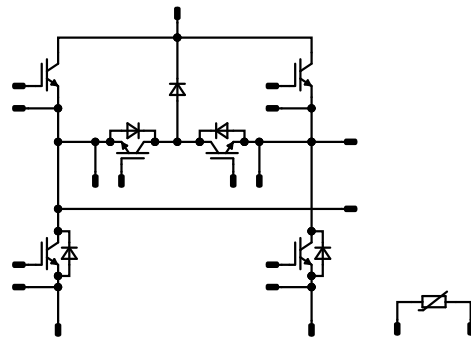



Vincotech

10-FY07HVA075RG-L985F88  
datasheet

## Maximum Ratings

$T_j = 25\text{ °C}$ , unless otherwise specified

Parameter	Symbol	Conditions	Value	Unit
-----------	--------	------------	-------	------

### Buck Switch

Collector-emitter voltage	$V_{CES}$		650	V
Collector current (DC current)	$I_C$	$T_j = T_{jmax}$ $T_s = 80\text{ °C}$	58	A
Repetitive peak collector current	$I_{CRM}$	$t_p$ limited by $T_{jmax}$	300	A
Total power dissipation	$P_{tot}$	$T_j = T_{jmax}$ $T_s = 80\text{ °C}$	88	W
Gate-emitter voltage	$V_{GES}$		$\pm 30$	V
Maximum junction temperature	$T_{jmax}$		175	°C

### Buck Diode

Peak repetitive reverse voltage	$V_{RRM}$		650	V
Forward current (DC current)	$I_F$	$T_j = T_{jmax}$ $T_s = 80\text{ °C}$	42	A
Repetitive peak forward current	$I_{FRM}$	$t_p$ limited by $T_{jmax}$	200	A
Total power dissipation	$P_{tot}$	$T_j = T_{jmax}$ $T_s = 80\text{ °C}$	61	W
Maximum junction temperature	$T_{jmax}$		175	°C

### Boost Switch

Collector-emitter voltage	$V_{CES}$		650	V
Collector current (DC current)	$I_C$	$T_j = T_{jmax}$ $T_s = 80\text{ °C}$	58	A
Repetitive peak collector current	$I_{CRM}$	$t_p$ limited by $T_{jmax}$	300	A
Total power dissipation	$P_{tot}$	$T_j = T_{jmax}$ $T_s = 80\text{ °C}$	88	W
Gate-emitter voltage	$V_{GES}$		$\pm 30$	V
Maximum junction temperature	$T_{jmax}$		175	°C

**Maximum Ratings** $T_j = 25\text{ °C}$ , unless otherwise specified

Parameter	Symbol	Conditions	Value	Unit
<b>Boost Diode</b>				
Peak repetitive reverse voltage	$V_{RRM}$		650	V
Forward current (DC current)	$I_F$	$T_j = T_{jmax}$ $T_s = 80\text{ °C}$	42	A
Repetitive peak forward current	$I_{FRM}$	$t_p$ limited by $T_{jmax}$	200	A
Total power dissipation	$P_{tot}$	$T_j = T_{jmax}$ $T_s = 80\text{ °C}$	61	W
Maximum junction temperature	$T_{jmax}$		175	°C

**Module Properties****Thermal Properties**

Storage temperature	$T_{stg}$		-40...+125	°C
Operation temperature under switching condition	$T_{jop}$		-40...+( $T_{jmax} - 25$ )	°C

**Isolation Properties**

Isolation voltage	$V_{isol}$	DC Test Voltage* $t_p = 2\text{ s}$	6000	V
Isolation voltage	$V_{isol}$	AC Voltage $t_p = 1\text{ min}$	2500	V
Creepage distance			>12,7	mm
Clearance			7,85	mm
Comparative Tracking Index	CTI		≥ 200	

\*100 % tested in production



Vincotech

### Characteristic Values

Parameter	Symbol	Conditions					Values			Unit
		$V_{GE}$ [V] $V_{GS}$ [V]	$V_{CE}$ [V] $V_{DS}$ [V] $V_F$ [V]	$I_C$ [A] $I_D$ [A] $I_F$ [A]	$T_j$ [°C]	Min	Typ	Max		

#### Buck Switch

##### Static

Gate-emitter threshold voltage	$V_{GE(th)}$		5	0,0504	25	5	6	7	V
Collector-emitter saturation voltage	$V_{CE(sat)}$	15		75	25 125 150		1,43 1,58 1,61	1,9 <sup>(1)</sup>	V
Collector-emitter cut-off current	$I_{CES}$	0	650		25			10	μA
Gate-emitter leakage current	$I_{GES}$	30	0		25			0,2	μA
Internal gate resistance	$r_g$						None		Ω

##### Thermal

Thermal resistance junction to sink <sup>(2)</sup>	$R_{th(j-s)}$	$\lambda_{paste} = 3,4$ W/mK (PSX)					1,08		K/W
--	---------------	---------------------------------------	--	--	--	--	------	--	-----

##### Dynamic

Turn-on delay time	$t_{d(on)}$	$R_{gon} = 4 \Omega$ $R_{goff} = 4 \Omega$	-5/15	400	75	25		36,8		ns				
						125		36,16						
						150		36,48						
Rise time	$t_r$									25		10,24		ns
										125		9,92		
										150		9,92		
Turn-off delay time	$t_{d(off)}$									25		83,52		ns
										125		95,04		
										150		98,24		
Fall time	$t_f$									25		31,61		ns
										125		46,31		
										150		51,12		
Turn-on energy (per pulse)	$E_{on}$	$Q_{iFWD} = 3,02 \mu C$ $Q_{iFWD} = 4,28 \mu C$ $Q_{iFWD} = 4,93 \mu C$				25		0,281		mWs				
						125		0,427						
						150		0,515						
Turn-off energy (per pulse)	$E_{off}$					25		1,24		mWs				
						125		1,64						
						150		1,77						





Vincotech

10-FY07HVA075RG-L985F88  
datasheet

### Characteristic Values

Parameter	Symbol	Conditions					Values			Unit
		$V_{GE}$ [V] $V_{GS}$ [V]	$V_{CE}$ [V] $V_{DS}$ [V] $V_F$ [V]	$I_C$ [A] $I_D$ [A] $I_F$ [A]	$T_j$ [°C]	Min	Typ	Max		

#### Buck Diode

##### Static

Forward voltage	$V_F$				50	25 125 150		1,51 1,57 1,54	1,9 <sup>(1)</sup>	V
Reverse leakage current	$I_R$	$V_T = 650$ V				25			10	μA

##### Thermal

Thermal resistance junction to sink <sup>(2)</sup>	$R_{th(j-s)}$	$\lambda_{paste} = 3,4$ W/mK (PSX)						1,55		K/W
--	---------------	---------------------------------------	--	--	--	--	--	------	--	-----

##### Dynamic

Peak recovery current	$I_{RRM}$					25 125 150		121,73 137,4 142,73		A
Reverse recovery time	$t_{rr}$					25 125 150		42,5 50,56 82,49		ns
Recovered charge	$Q_r$	$di/dt=9810$ A/μs $di/dt=8653$ A/μs $di/dt=8616$ A/μs	-5/15	400	75	25 125 150		3,02 4,28 4,93		μC
Reverse recovered energy	$E_{rec}$					25 125 150		1,18 1,58 1,79		mWs
Peak rate of fall of recovery current	$(di_r/dt)_{max}$					25 125 150		4616 5305 5143		A/μs



Vincotech

### Characteristic Values

Parameter	Symbol	Conditions					Values			Unit
		$V_{GE}$ [V] $V_{GS}$ [V]	$V_{CE}$ [V] $V_{DS}$ [V] $V_F$ [V]	$I_C$ [A] $I_D$ [A] $I_F$ [A]	$T_j$ [°C]	Min	Typ	Max		

#### Boost Switch

##### Static

Gate-emitter threshold voltage	$V_{GE(th)}$		5	0,0504	25	5	6	7	V
Collector-emitter saturation voltage	$V_{CE(sat)}$	15		75	25 125 150		1,43 1,58 1,61	1,9 <sup>(1)</sup>	V
Collector-emitter cut-off current	$I_{CES}$	0	650		25			10	μA
Gate-emitter leakage current	$I_{GES}$	30	0		25			0,2	μA
Internal gate resistance	$r_g$						None		Ω

##### Thermal

Thermal resistance junction to sink <sup>(2)</sup>	$R_{th(j-s)}$	$\lambda_{paste} = 3,4$ W/mK (PSX)					1,08		K/W
--	---------------	---------------------------------------	--	--	--	--	------	--	-----

##### Dynamic

Turn-on delay time	$t_{d(on)}$	$R_{gon} = 4 \Omega$ $R_{goff} = 4 \Omega$	-5/15	400	75	25		37,76		ns				
						125		37,44						
						150		36,16						
Rise time	$t_r$									25		9,28		ns
										125		10,24		
										150		9,92		
Turn-off delay time	$t_{d(off)}$									25		85,44		ns
										125		95,68		
										150		99,52		
Fall time	$t_f$									25		30,66		ns
										125		40,66		
										150		46,96		
Turn-on energy (per pulse)	$E_{on}$	$Q_{iFWD} = 2,92 \mu C$ $Q_{iFWD} = 4,03 \mu C$ $Q_{iFWD} = 4,45 \mu C$				25		0,31		mWs				
						125		0,465						
						150		0,473						
Turn-off energy (per pulse)	$E_{off}$					25		1,23		mWs				
						125		1,7						
						150		1,76						



Vincotech

10-FY07HVA075RG-L985F88  
datasheet

### Characteristic Values

Parameter	Symbol	Conditions					Values			Unit
		$V_{GE}$ [V] $V_{GS}$ [V]	$V_{CE}$ [V] $V_{DS}$ [V] $V_F$ [V]	$I_C$ [A] $I_D$ [A] $I_F$ [A]	$T_j$ [°C]	Min	Typ	Max		
<b>Boost Diode</b>										
<b>Static</b>										
Forward voltage	$V_F$			50	25 125 150		1,51 1,57 1,54	1,9 <sup>(1)</sup>		V
Reverse leakage current	$I_R$	$V_r = 650$ V			25			10		μA
<b>Thermal</b>										
Thermal resistance junction to sink <sup>(2)</sup>	$R_{th(j-s)}$	$\lambda_{paste} = 3,4$ W/mK (PSX)					1,55			K/W
<b>Dynamic</b>										
Peak recovery current	$I_{RRM}$				25 125 150		119,35 129,88 134,15			A
Reverse recovery time	$t_{rr}$				25 125 150		39,26 75,52 81,16			ns
Recovered charge	$Q_r$	$di/dt=9967$ A/μs $di/dt=9232$ A/μs $di/dt=8568$ A/μs	-5/15	400	75	25 125 150	2,92 4,03 4,45			μC
Reverse recovered energy	$E_{rec}$				25 125 150		1,12 1,46 1,54			mWs
Peak rate of fall of recovery current	$(di_r/dt)_{max}$				25 125 150		5401 5948 5896			A/μs



Vincotech

### Characteristic Values

Parameter	Symbol	Conditions					Values			Unit
		$V_{GS}$ [V]	$V_{GE}$ [V]	$V_{DS}$ [V]	$V_{CE}$ [V]	$T_j$ [°C]	Min	Typ	Max	

### Thermistor

#### Static

Rated resistance	$R$					25		22		kΩ
Deviation of $R_{100}$	$A_{R/R}$	$R_{100} = 1484 \Omega$				100	-5		5	%
Power dissipation	$P$							5		mW
Power dissipation constant	$d$					25		1,5		mW/K
B-value	$B_{(25/50)}$	Tol. $\pm 1 \%$						3962		K
B-value	$B_{(25/100)}$	Tol. $\pm 1 \%$						4000		K
Vincotech Thermistor Reference									I	

<sup>(1)</sup> Value at chip level

<sup>(2)</sup> Only valid with pre-applied Vincotech thermal interface material.



## Buck Switch Characteristics

**figure 1.** IGBT

Typical output characteristics

$$I_c = f(V_{CE})$$

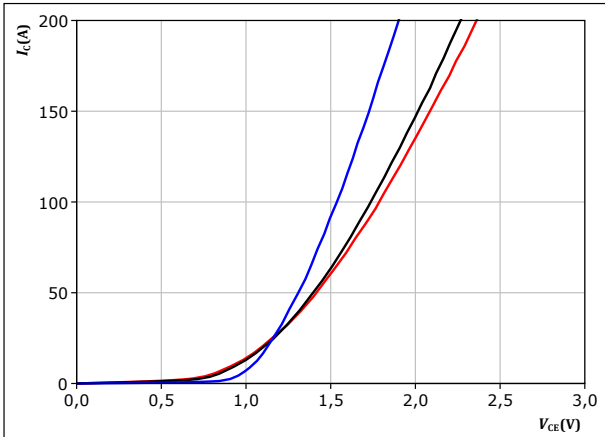

$t_p = 250 \mu s$   
 $V_{GE} = 15 V$

$T_j$ :  
— 25 °C  
— 125 °C  
— 150 °C

**figure 2.** IGBT

Typical output characteristics

$$I_c = f(V_{CE})$$

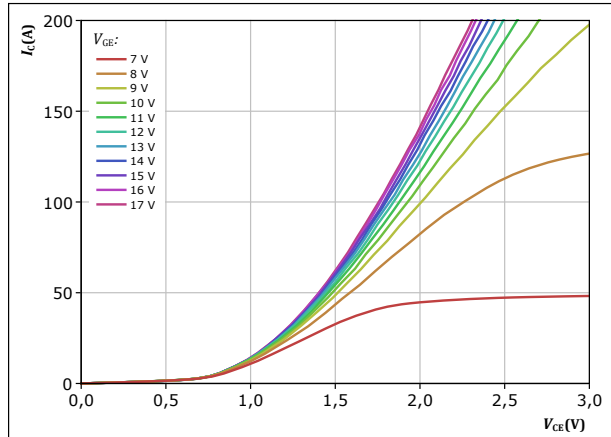

$t_p = 250 \mu s$   
 $T_j = 150 \text{ °C}$   
 $V_{GE}$  from 7 V to 17 V in steps of 1 V

**figure 3.** IGBT

Typical transfer characteristics

$$I_c = f(V_{GE})$$

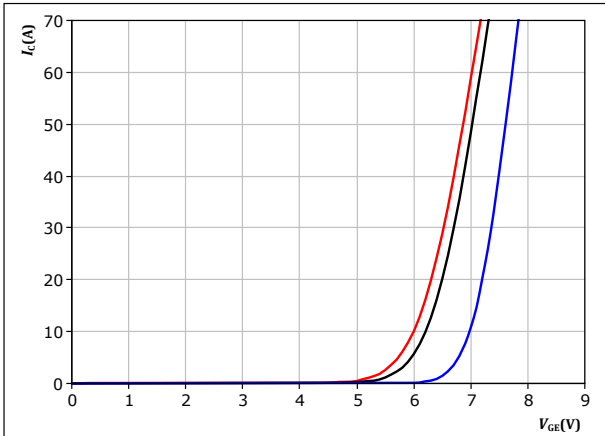

$t_p = 250 \mu s$   
 $V_{CE} = 14 V$

$T_j$ :  
— 25 °C  
— 125 °C  
— 150 °C

**figure 4.** IGBT

Transient thermal impedance as a function of pulse width

$$Z_{th(j-s)} = f(t_p)$$

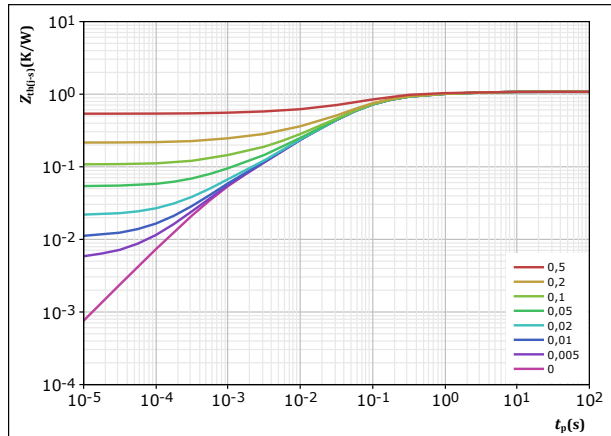

$D = t_p / T$   
 $R_{th(j-s)} = 1,078 \text{ K/W}$

IGBT thermal model values

$R$ (K/W)	$\tau$ (s)
8,14E-02	2,67E+00
1,88E-01	3,44E-01
6,08E-01	6,67E-02
1,59E-01	9,52E-03
4,09E-02	8,22E-04



### Buck Switch Characteristics

figure 5. IGBT

Safe operating area

$$I_C = f(V_{CE})$$

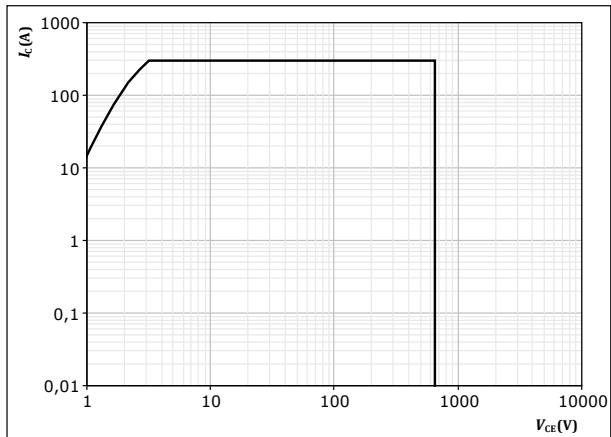

D = single pulse  
T<sub>s</sub> = 80 °C  
V<sub>CE</sub> = 15 V  
T<sub>j</sub> = T<sub>jmax</sub>



## Buck Diode Characteristics

figure 6. FWD

Typical forward characteristics

$$I_F = f(V_F)$$

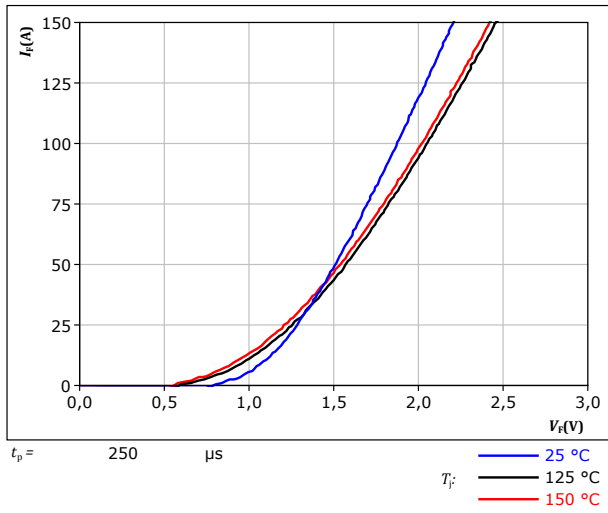
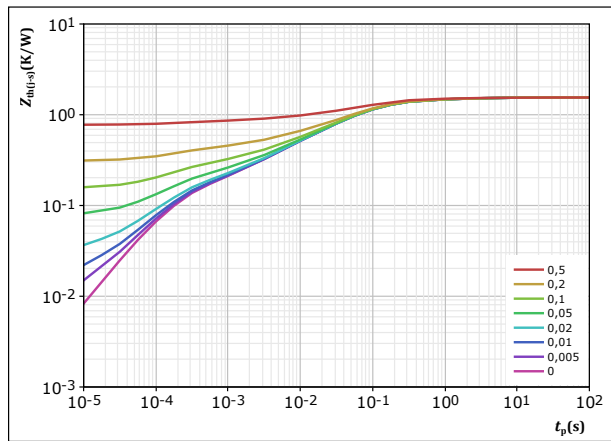

figure 7. FWD

Transient thermal impedance as a function of pulse width

$$Z_{th(j-s)} = f(t_p)$$



$D = \frac{t_p}{T}$   
 $R_{th(j-s)} = 1,548 \text{ K/W}$   
 FWD thermal model values

$R$ (K/W)	$\tau$ (s)
4,44E-02	5,26E+00
1,14E-01	8,12E-01
4,83E-01	1,25E-01
4,67E-01	4,08E-02
2,41E-01	7,57E-03
7,79E-02	1,14E-03
1,22E-01	1,66E-04



### Boost Switch Characteristics

**figure 8.** IGBT

Typical output characteristics  
 $I_C = f(V_{CE})$

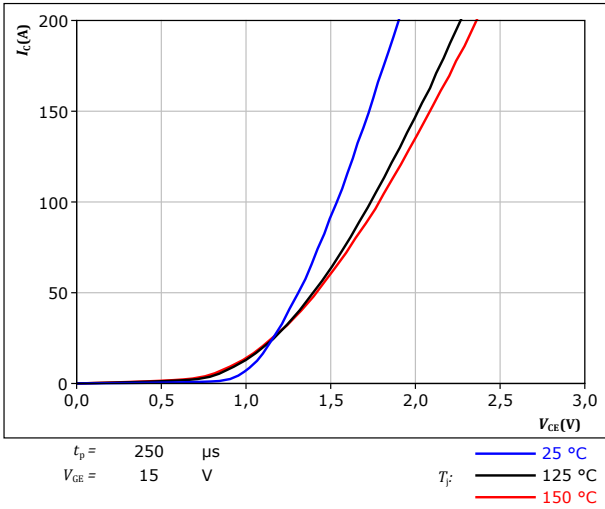

**figure 9.** IGBT

Typical output characteristics  
 $I_C = f(V_{CE})$

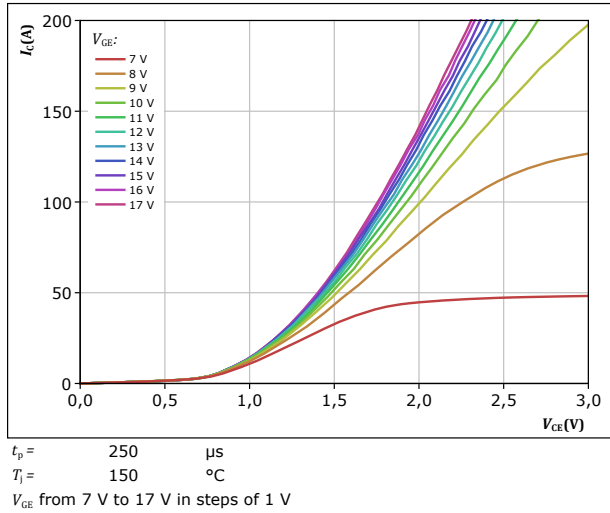

**figure 10.** IGBT

Typical transfer characteristics  
 $I_C = f(V_{GE})$

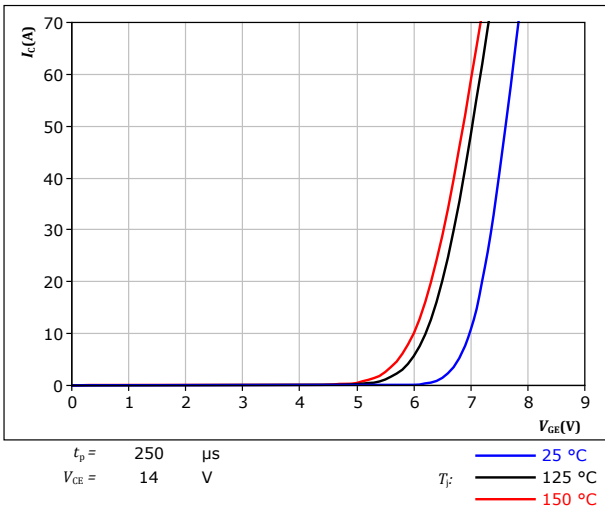

**figure 11.** IGBT

Transient thermal impedance as a function of pulse width  
 $Z_{th(j-s)} = f(t_p)$

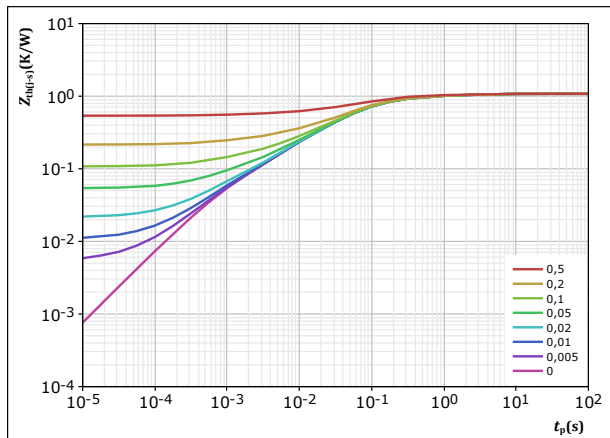

$D = t_p / T$   
 $R_{th(j-s)} = 1,078 \text{ K/W}$

IGBT thermal model values

$R$ (K/W)	$\tau$ (s)
8,14E-02	2,67E+00
1,88E-01	3,44E-01
6,08E-01	6,67E-02
1,59E-01	9,52E-03
4,09E-02	8,22E-04





### Boost Switch Characteristics

figure 12. IGBT

Safe operating area

$$I_C = f(V_{CE})$$

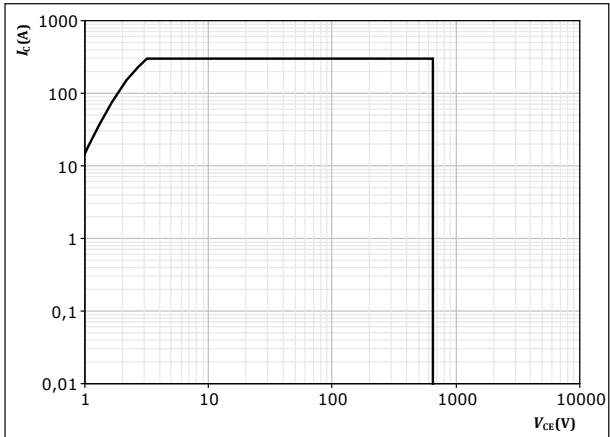

D = single pulse

T<sub>s</sub> = 80 °C

V<sub>GE</sub> = 15 V

T<sub>j</sub> = T<sub>jmax</sub>



### Boost Diode Characteristics

figure 13. FWD

Typical forward characteristics

$$I_F = f(V_F)$$

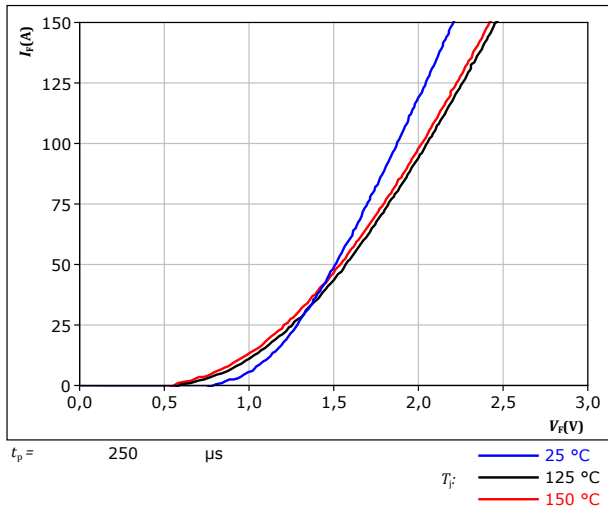
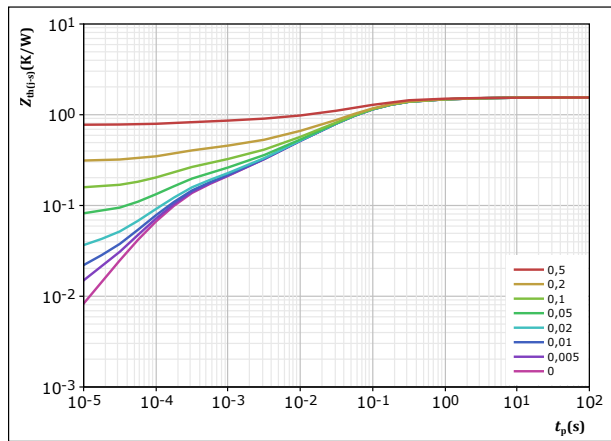

figure 14. FWD

Transient thermal impedance as a function of pulse width

$$Z_{th(j-s)} = f(t_p)$$



$D = \frac{t_p}{T}$   
 $R_{th(j-s)} = 1,548 \text{ K/W}$   
 FWD thermal model values

$R$ (K/W)	$\tau$ (s)
4,44E-02	5,26E+00
1,14E-01	8,12E-01
4,83E-01	1,25E-01
4,67E-01	4,08E-02
2,41E-01	7,57E-03
7,79E-02	1,14E-03
1,22E-01	1,66E-04



## Thermistor Characteristics

figure 15. Thermistor

Typical NTC characteristic as function of temperature

$$R_T = f(T)$$

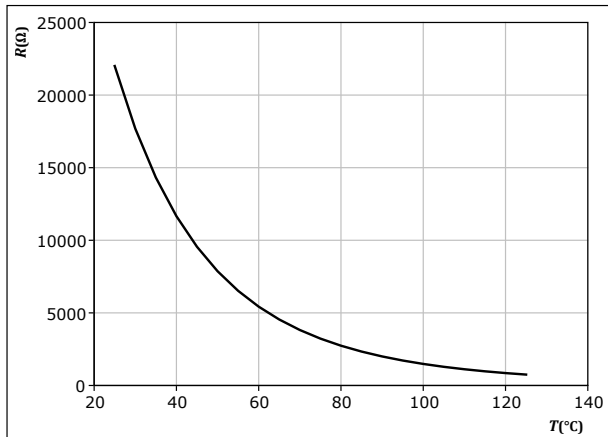



## Buck Switching Characteristics

**figure 16.** IGBT

Typical switching energy losses as a function of collector current  
 $E = f(I_c)$

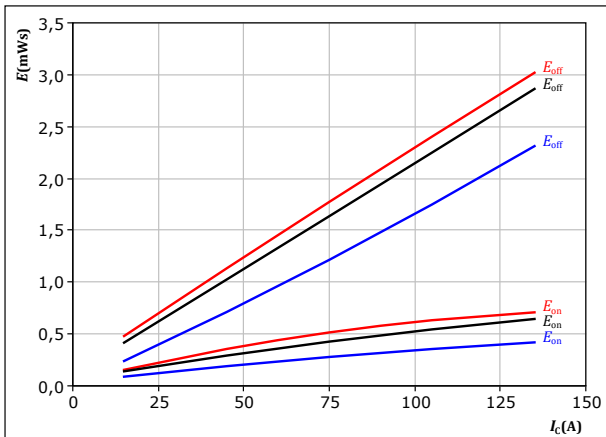

With an inductive load at  
 $V_{CE} = 400$  V  
 $V_{GE} = -5/15$  V  
 $R_{gon} = 4$  Ω  
 $R_{goff} = 4$  Ω

$T_f$ : — 25 °C  
 — 125 °C  
 — 150 °C

**figure 17.** IGBT

Typical switching energy losses as a function of gate resistor  
 $E = f(R_g)$

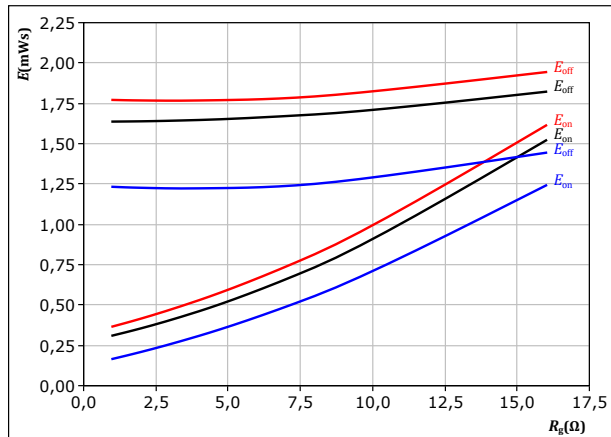

With an inductive load at  
 $V_{CE} = 400$  V  
 $V_{GE} = -5/15$  V  
 $I_c = 75$  A

$T_f$ : — 25 °C  
 — 125 °C  
 — 150 °C

**figure 18.** FWD

Typical reverse recovered energy loss as a function of collector current  
 $E_{rec} = f(I_c)$

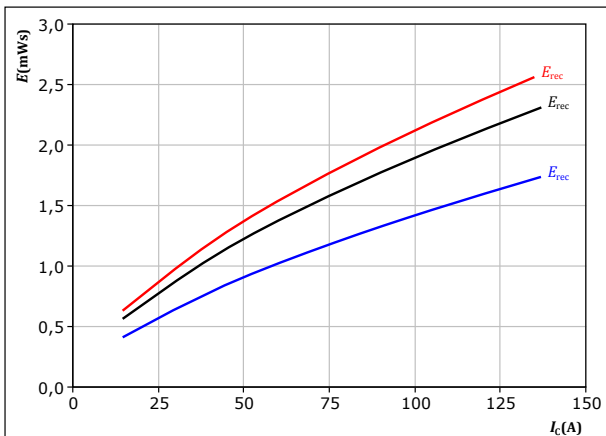

With an inductive load at  
 $V_{CE} = 400$  V  
 $V_{GE} = -5/15$  V  
 $R_{gon} = 4$  Ω

$T_f$ : — 25 °C  
 — 125 °C  
 — 150 °C

**figure 19.** FWD

Typical reverse recovered energy loss as a function of gate resistor  
 $E_{rec} = f(R_g)$

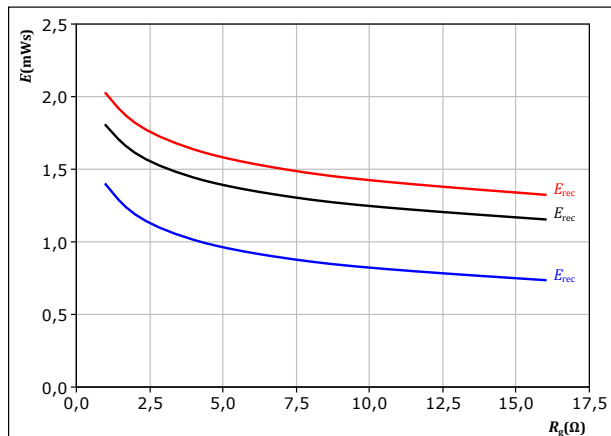

With an inductive load at  
 $V_{CE} = 400$  V  
 $V_{GE} = -5/15$  V  
 $I_c = 75$  A

$T_f$ : — 25 °C  
 — 125 °C  
 — 150 °C



## Buck Switching Characteristics

**figure 20.** IGBT

Typical switching times as a function of collector current  
 $t = f(I_c)$

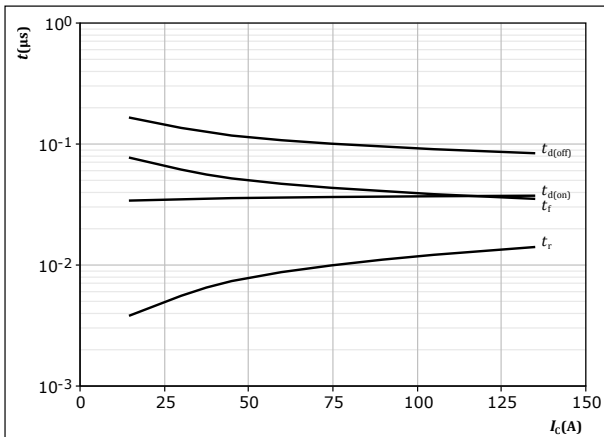

With an inductive load at  
 $T_j = 150 \text{ }^\circ\text{C}$   
 $V_{CE} = 400 \text{ V}$   
 $V_{GE} = -5/15 \text{ V}$   
 $R_{gon} = 4 \text{ } \Omega$   
 $R_{goff} = 4 \text{ } \Omega$

**figure 21.** IGBT

Typical switching times as a function of gate resistor  
 $t = f(R_g)$

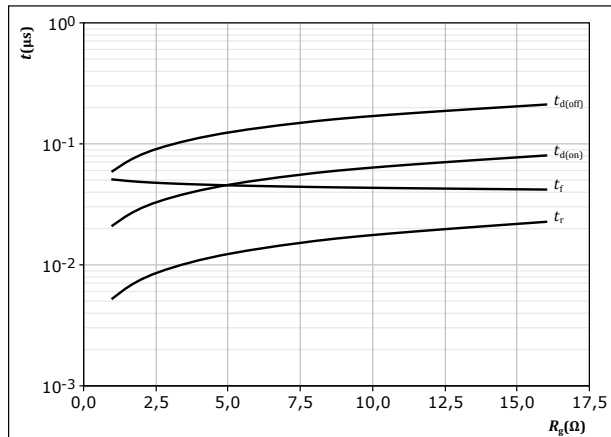

With an inductive load at  
 $T_j = 150 \text{ }^\circ\text{C}$   
 $V_{CE} = 400 \text{ V}$   
 $V_{GE} = -5/15 \text{ V}$   
 $I_c = 75 \text{ A}$

**figure 22.** FWD

Typical reverse recovery time as a function of collector current  
 $t_{rr} = f(I_c)$

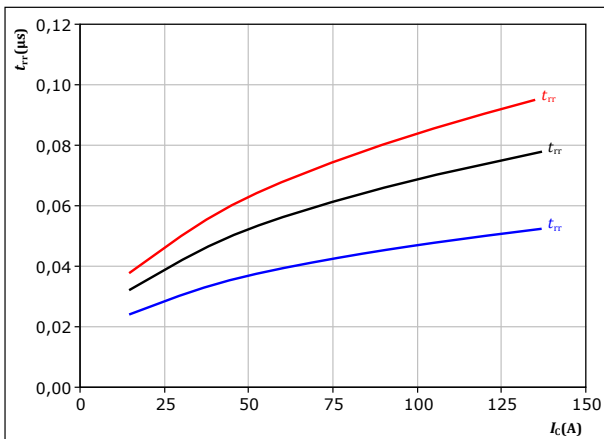

With an inductive load at  
 $V_{CE} = 400 \text{ V}$   
 $V_{GE} = -5/15 \text{ V}$   
 $R_{gon} = 4 \text{ } \Omega$

$T_j$ :  
— 25 °C  
— 125 °C  
— 150 °C

**figure 23.** FWD

Typical reverse recovery time as a function of IGBT turn off gate resistor  
 $t_{rr} = f(R_{goff})$

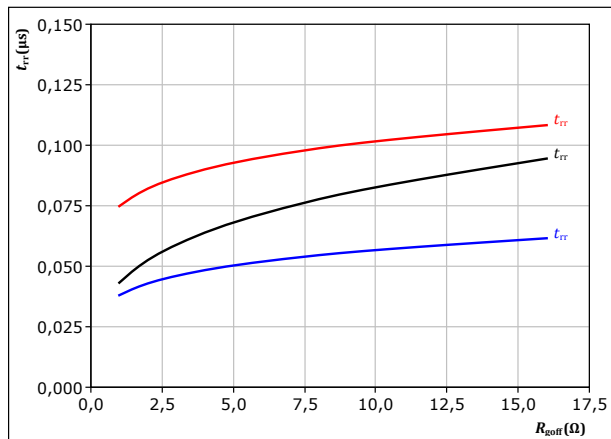

With an inductive load at  
 $V_{CE} = 400 \text{ V}$   
 $V_{GE} = -5/15 \text{ V}$   
 $I_c = 75 \text{ A}$

$T_j$ :  
— 25 °C  
— 125 °C  
— 150 °C



## Buck Switching Characteristics

**figure 24.** FWD

Typical recovered charge as a function of collector current

$$Q_r = f(I_c)$$

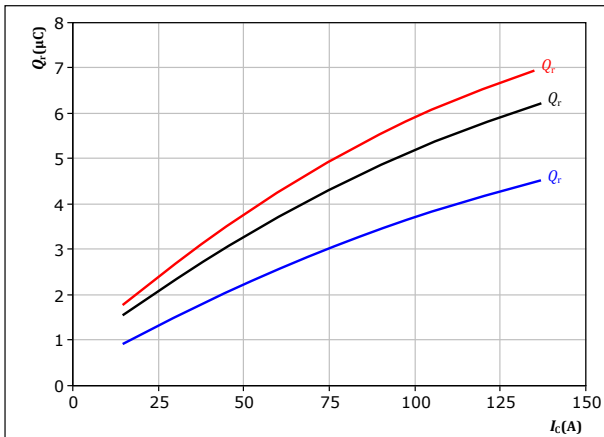

With an inductive load at

$V_{CE} = 400 \text{ V}$   
 $V_{GE} = -5/15 \text{ V}$   
 $R_{goff} = 4 \text{ } \Omega$

$T_j$ : — 25 °C  
— 125 °C  
— 150 °C

**figure 25.** FWD

Typical recovered charge as a function of turn off gate resistor

$$Q_r = f(R_{goff})$$

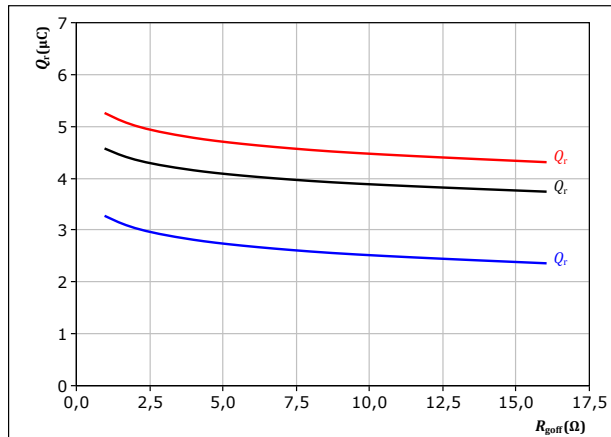

With an inductive load at

$V_{CE} = 400 \text{ V}$   
 $V_{GE} = -5/15 \text{ V}$   
 $I_c = 75 \text{ A}$

$T_j$ : — 25 °C  
— 125 °C  
— 150 °C

**figure 26.** FWD

Typical peak reverse recovery current as a function of collector current

$$I_{RM} = f(I_c)$$

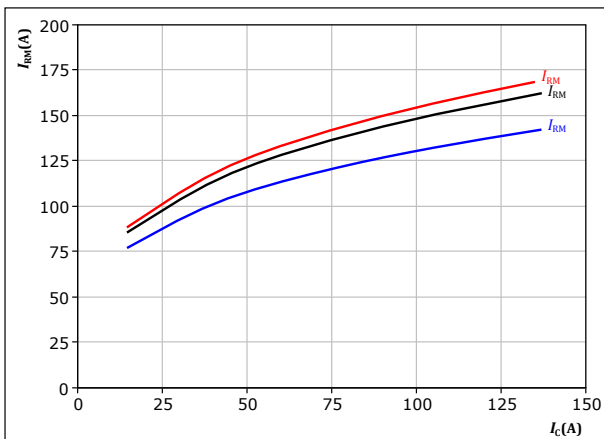

With an inductive load at

$V_{CE} = 400 \text{ V}$   
 $V_{GE} = -5/15 \text{ V}$   
 $R_{goff} = 4 \text{ } \Omega$

$T_j$ : — 25 °C  
— 125 °C  
— 150 °C

**figure 27.** FWD

Typical peak reverse recovery current as a function of turn off gate resistor

$$I_{RM} = f(R_{goff})$$

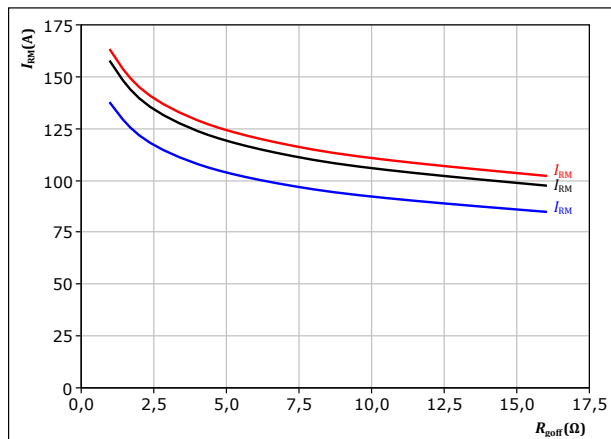

With an inductive load at

$V_{CE} = 400 \text{ V}$   
 $V_{GE} = -5/15 \text{ V}$   
 $I_c = 75 \text{ A}$

$T_j$ : — 25 °C  
— 125 °C  
— 150 °C



## Buck Switching Characteristics

**figure 28.** FWD

Typical rate of fall of forward and reverse recovery current as a function of collector current  
 $di_i/dt, di_r/dt = f(I_c)$

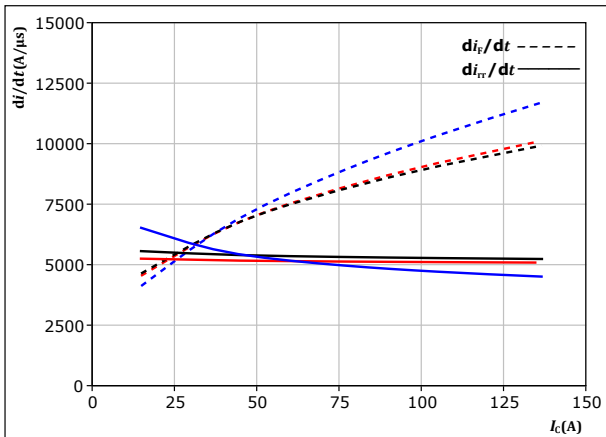

With an inductive load at

$V_{CE} = 400$  V  
 $V_{GE} = -5/15$  V  
 $R_{goff} = 4$  Ω

$T_j$ : — 25 °C  
 — 125 °C  
 — 150 °C

**figure 29.** FWD

Typical rate of fall of forward and reverse recovery current as a function of turn off gate resistor  
 $di_i/dt, di_r/dt = f(R_{goff})$

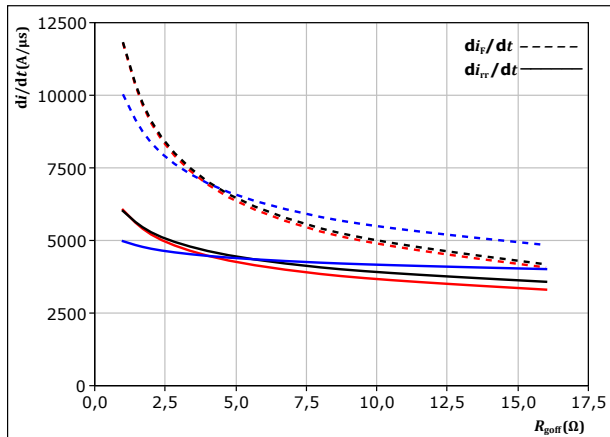

With an inductive load at

$V_{CE} = 400$  V  
 $V_{GE} = -5/15$  V  
 $I_c = 75$  A

$T_j$ : — 25 °C  
 — 125 °C  
 — 150 °C

**figure 30.** IGBT

Reverse bias safe operating area

$I_c = f(V_{CE})$

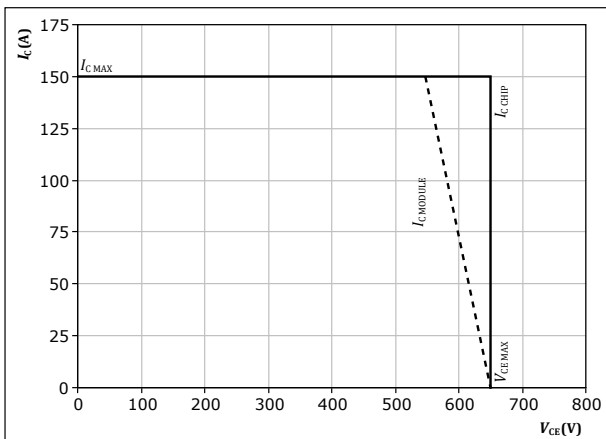

At  $T_j = 150$  °C  
 $R_{goff} = 4$  Ω  
 $R_{goff} = 4$  Ω



## Boost Switching Characteristics

**figure 31.** IGBT

Typical switching energy losses as a function of collector current  
 $E = f(I_c)$

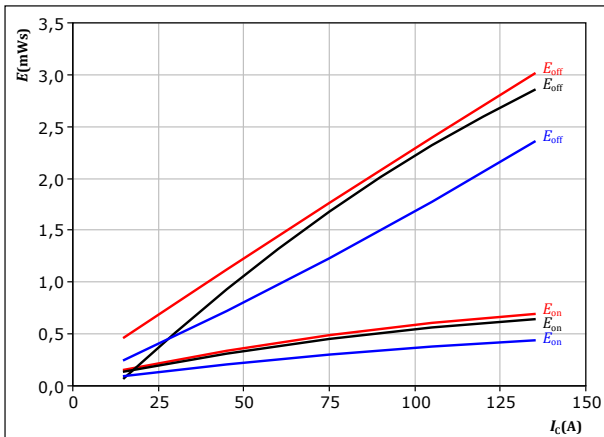

With an inductive load at  
 $V_{CE} = 400 \text{ V}$   
 $V_{GE} = -5/15 \text{ V}$   
 $R_{g(on)} = 4 \text{ } \Omega$   
 $R_{g(off)} = 4 \text{ } \Omega$

$T_j$ : — 25 °C  
 — 125 °C  
 — 150 °C

**figure 32.** IGBT

Typical switching energy losses as a function of gate resistor  
 $E = f(R_g)$

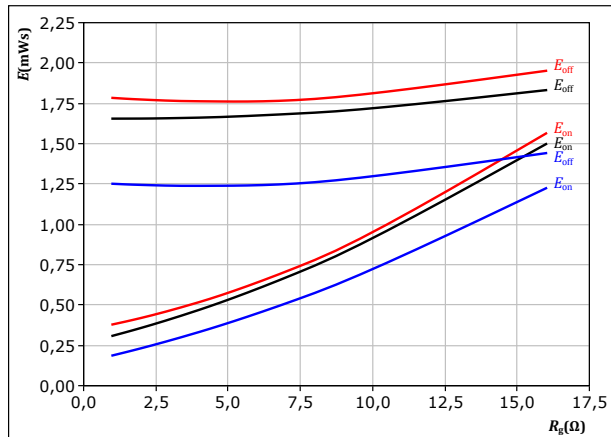

With an inductive load at  
 $V_{CE} = 400 \text{ V}$   
 $V_{GE} = -5/15 \text{ V}$   
 $I_c = 75 \text{ A}$

$T_j$ : — 25 °C  
 — 125 °C  
 — 150 °C

**figure 33.** FWD

Typical reverse recovered energy loss as a function of collector current  
 $E_{rec} = f(I_c)$

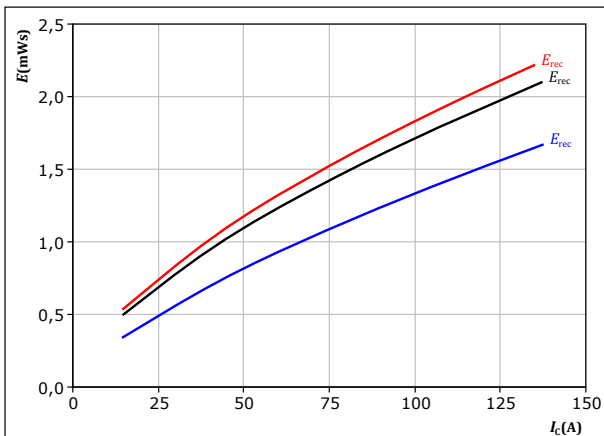

With an inductive load at  
 $V_{CE} = 400 \text{ V}$   
 $V_{GE} = -5/15 \text{ V}$   
 $R_{g(on)} = 4 \text{ } \Omega$

$T_j$ : — 25 °C  
 — 125 °C  
 — 150 °C

**figure 34.** FWD

Typical reverse recovered energy loss as a function of gate resistor  
 $E_{rec} = f(R_g)$

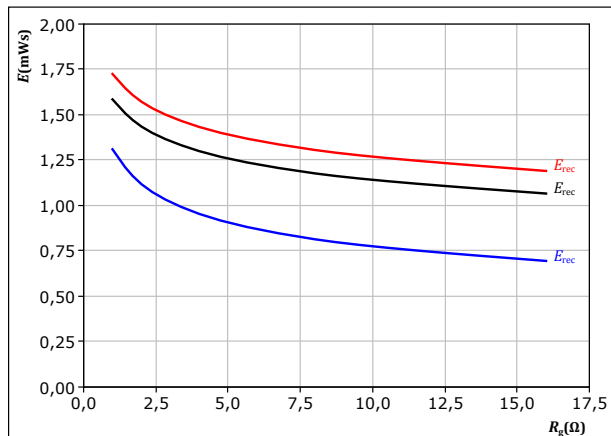

With an inductive load at  
 $V_{CE} = 400 \text{ V}$   
 $V_{GE} = -5/15 \text{ V}$   
 $I_c = 75 \text{ A}$

$T_j$ : — 25 °C  
 — 125 °C  
 — 150 °C





## Boost Switching Characteristics

**figure 35.** IGBT

Typical switching times as a function of collector current  
 $t = f(I_c)$

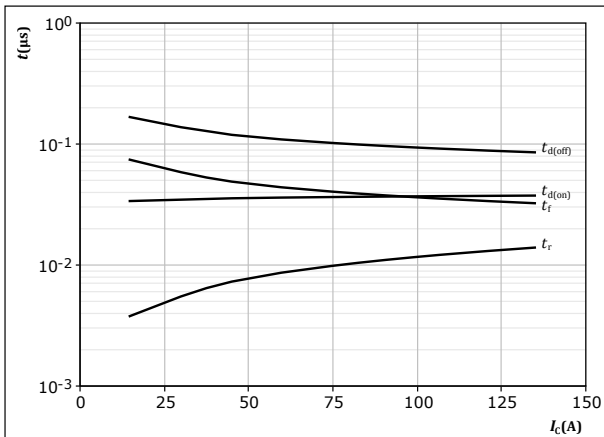

With an inductive load at  
 $T_j = 150$  °C  
 $V_{CE} = 400$  V  
 $V_{GE} = -5/15$  V  
 $R_{gon} = 4$  Ω  
 $R_{goff} = 4$  Ω

**figure 36.** IGBT

Typical switching times as a function of gate resistor  
 $t = f(R_g)$

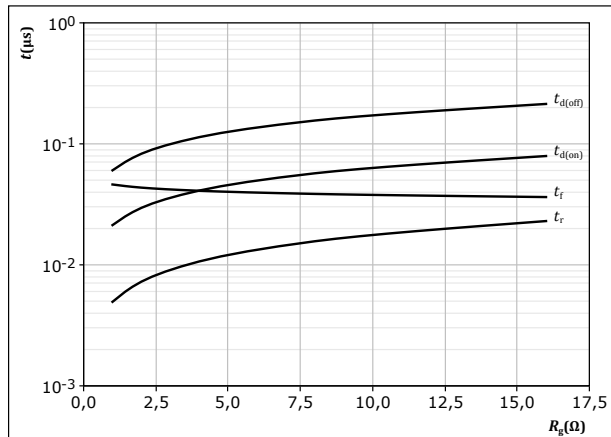

With an inductive load at  
 $T_j = 150$  °C  
 $V_{CE} = 400$  V  
 $V_{GE} = -5/15$  V  
 $I_c = 75$  A

**figure 37.** FWD

Typical reverse recovery time as a function of collector current  
 $t_{rr} = f(I_c)$

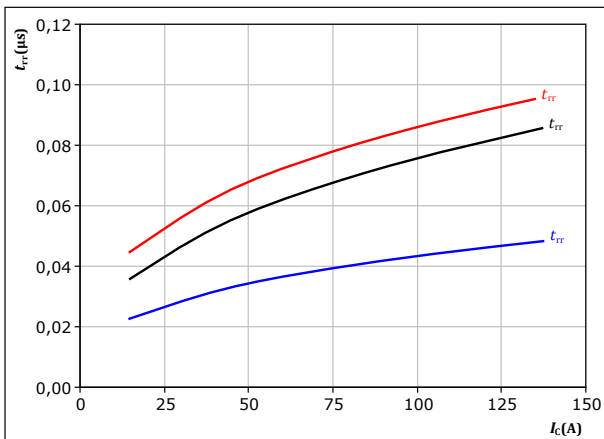

With an inductive load at  
 $V_{CE} = 400$  V  
 $V_{GE} = -5/15$  V  
 $R_{gon} = 4$  Ω  
 $T_j$ : — 25 °C  
— 125 °C  
— 150 °C

**figure 38.** FWD

Typical reverse recovery time as a function of IGBT turn off gate resistor  
 $t_{rr} = f(R_{goff})$

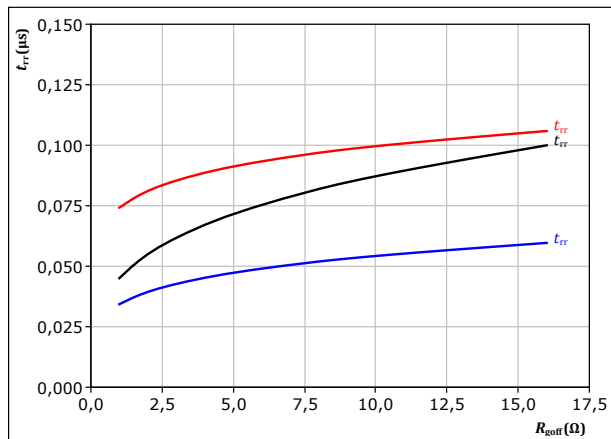

With an inductive load at  
 $V_{CE} = 400$  V  
 $V_{GE} = -5/15$  V  
 $I_c = 75$  A  
 $T_j$ : — 25 °C  
— 125 °C  
— 150 °C



## Boost Switching Characteristics

**figure 39.** FWD

Typical recovered charge as a function of collector current

$$Q_r = f(I_c)$$

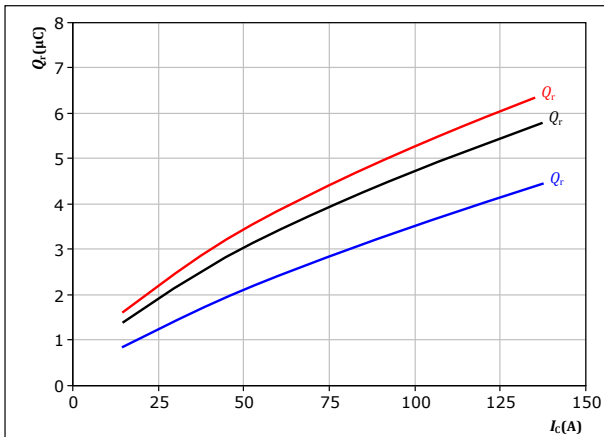

With an inductive load at

$V_{CE} = 400 \text{ V}$   
 $V_{GE} = -5/15 \text{ V}$   
 $R_{goff} = 4 \text{ } \Omega$

$T_j$ : — 25 °C  
— 125 °C  
— 150 °C

**figure 40.** FWD

Typical recovered charge as a function of turn off gate resistor

$$Q_r = f(R_{goff})$$

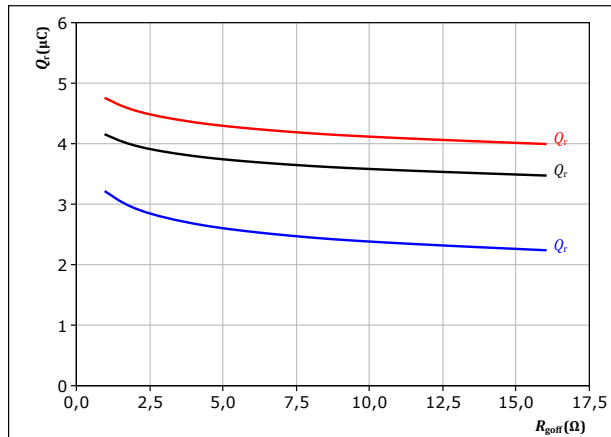

With an inductive load at

$V_{CE} = 400 \text{ V}$   
 $V_{GE} = -5/15 \text{ V}$   
 $I_c = 75 \text{ A}$

$T_j$ : — 25 °C  
— 125 °C  
— 150 °C

**figure 41.** FWD

Typical peak reverse recovery current as a function of collector current

$$I_{RM} = f(I_c)$$

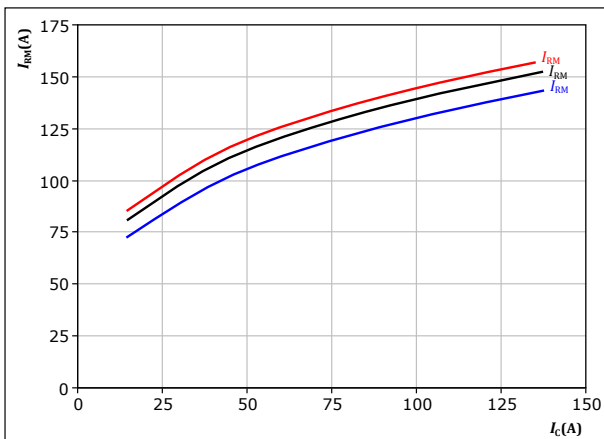

With an inductive load at

$V_{CE} = 400 \text{ V}$   
 $V_{GE} = -5/15 \text{ V}$   
 $R_{goff} = 4 \text{ } \Omega$

$T_j$ : — 25 °C  
— 125 °C  
— 150 °C

**figure 42.** FWD

Typical peak reverse recovery current as a function of turn off gate resistor

$$I_{RM} = f(R_{goff})$$

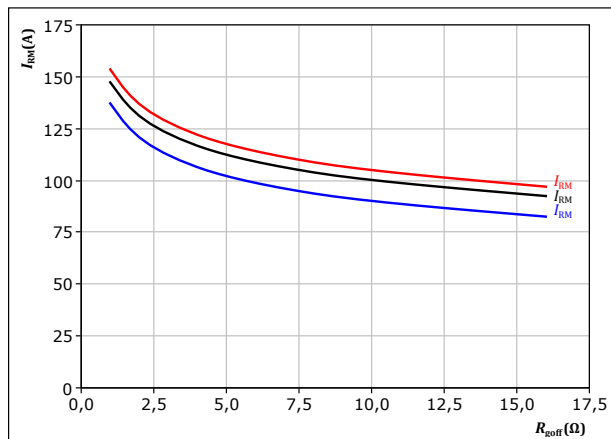

With an inductive load at

$V_{CE} = 400 \text{ V}$   
 $V_{GE} = -5/15 \text{ V}$   
 $I_c = 75 \text{ A}$

$T_j$ : — 25 °C  
— 125 °C  
— 150 °C



## Boost Switching Characteristics

figure 43. FWD

Typical rate of fall of forward and reverse recovery current as a function of collector current  
 $di_i/dt, di_r/dt = f(I_c)$

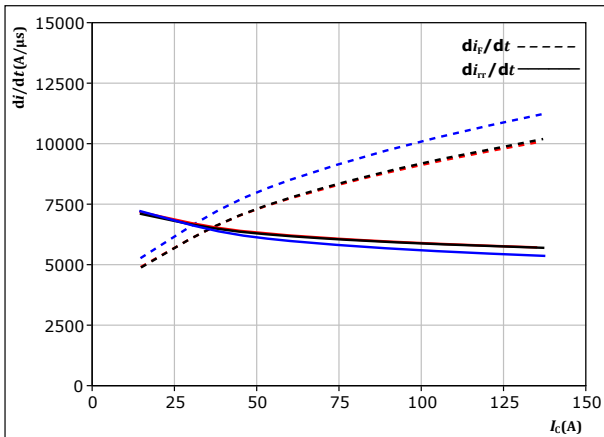

With an inductive load at

$V_{CE} = 400$  V  
 $V_{GE} = -5/15$  V  
 $R_{goff} = 4$  Ω

$T_j$ : 25 °C  
 125 °C  
 150 °C

figure 44. FWD

Typical rate of fall of forward and reverse recovery current as a function of turn off gate resistor  
 $di_i/dt, di_r/dt = f(R_{goff})$

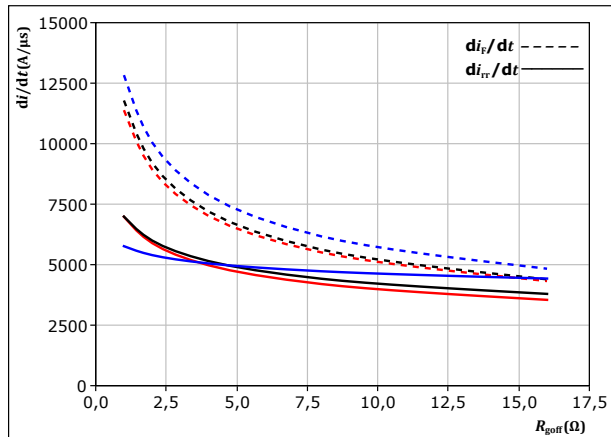

With an inductive load at

$V_{CE} = 400$  V  
 $V_{GE} = -5/15$  V  
 $I_c = 75$  A

$T_j$ : 25 °C  
 125 °C  
 150 °C

figure 45. IGBT

Reverse bias safe operating area

$I_c = f(V_{CE})$

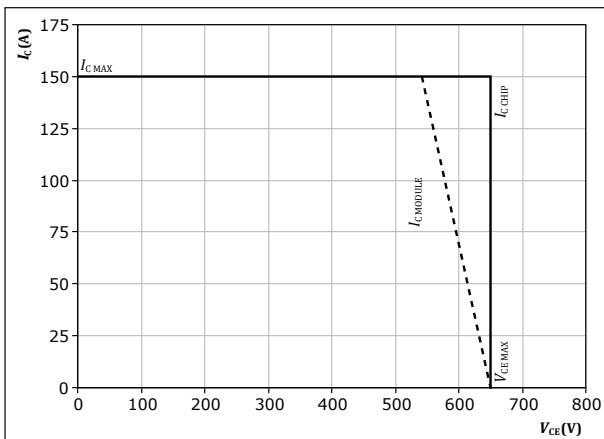

At  $T_j = 150$  °C  
 $R_{goff} = 4$  Ω  
 $R_{goff} = 4$  Ω



## Switching Definitions

**figure 46.** IGBT

Turn-off Switching Waveforms & definition of  $t_{doff}$ ,  $t_{Eoff}$  ( $t_{Eoff}$  = integrating time for  $E_{off}$ )

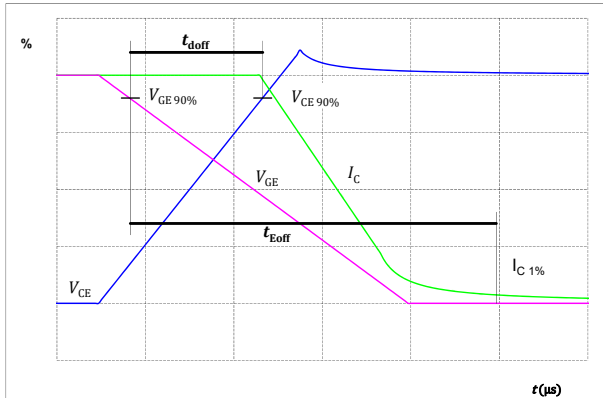

**figure 47.** IGBT

Turn-on Switching Waveforms & definition of  $t_{don}$ ,  $t_{Eon}$  ( $t_{Eon}$  = integrating time for  $E_{on}$ )

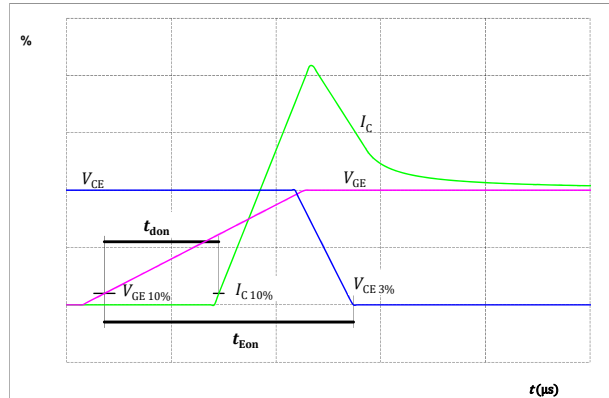

**figure 48.** IGBT

Turn-off Switching Waveforms & definition of  $t_f$

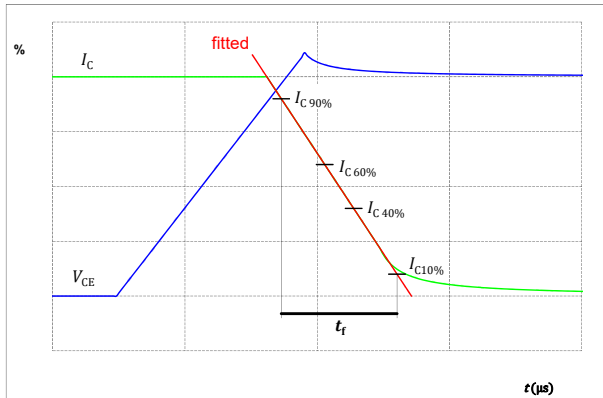

**figure 49.** IGBT

Turn-on Switching Waveforms & definition of  $t_r$

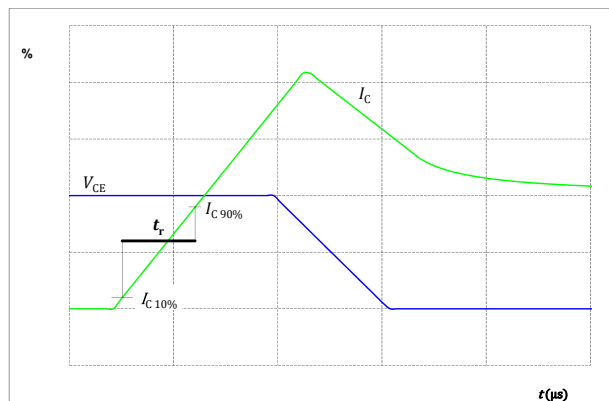



### Switching Definitions

figure 50. FWD

Turn-off Switching Waveforms & definition of  $t_{rr}$

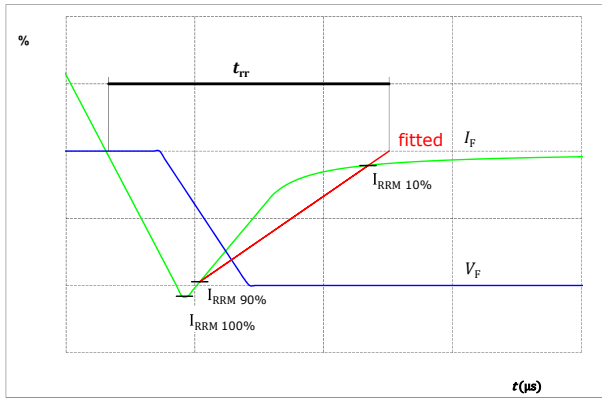
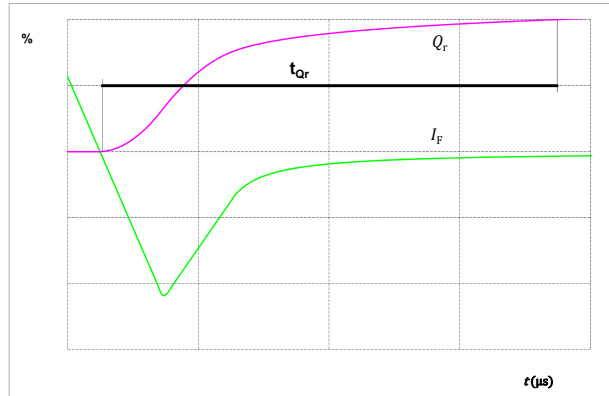

figure 51. FWD

Turn-on Switching Waveforms & definition of  $t_{Qr}$  ( $t_{Qr}$  = integrating time for  $Q_r$ )







Vincotech

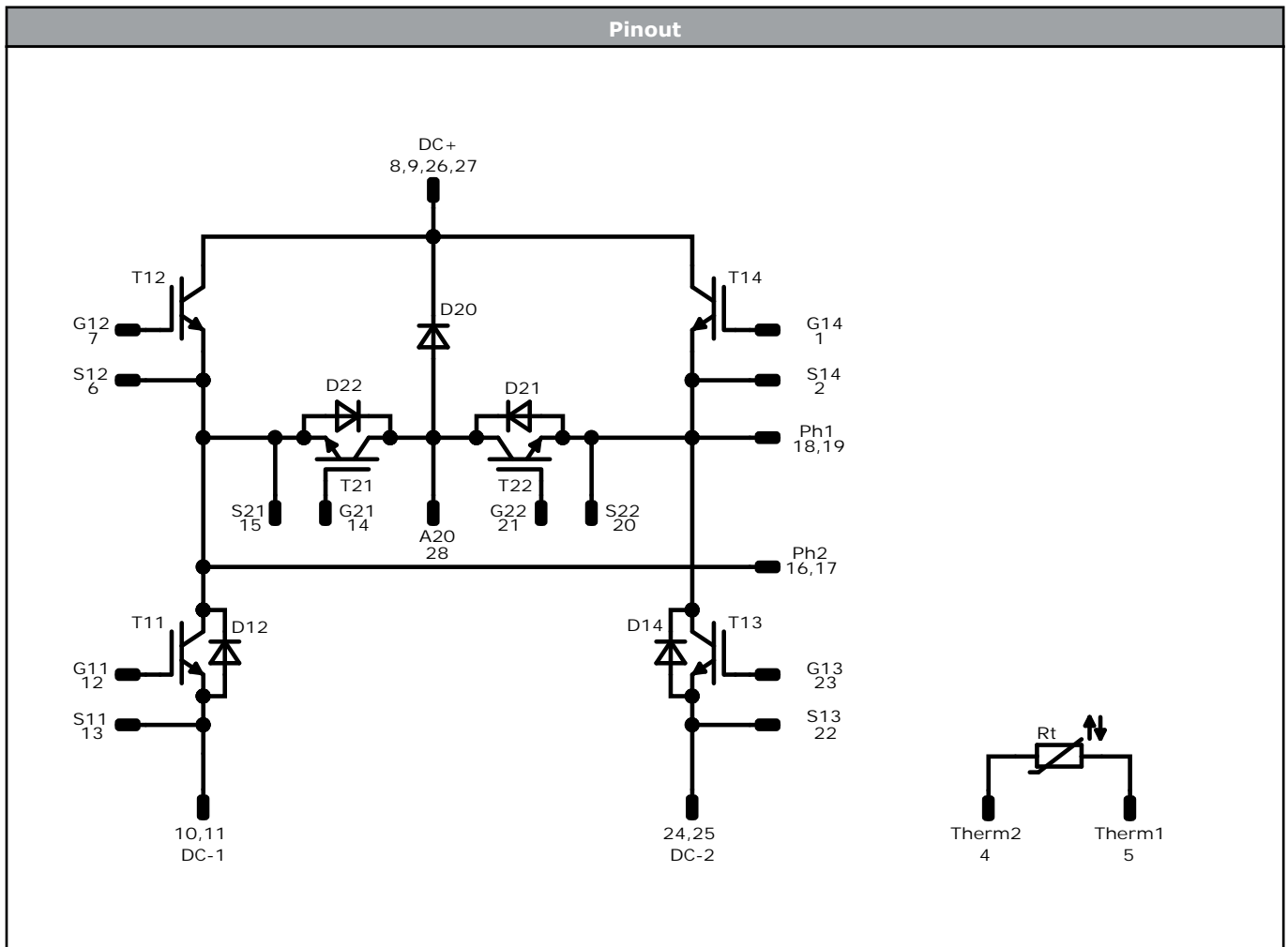

Identification					
ID	Component	Voltage	Current	Function	Comment
T11, T13, T12, T14	IGBT	650 V	75 A	Buck Switch	
D21, D22	FWD	650 V	50 A	Buck Diode	
T21, T22	IGBT	650 V	75 A	Boost Switch	
D12, D14, D20	FWD	650 V	50 A	Boost Diode	
Rt	Thermistor			Thermistor	



Vincotech

Packaging instruction				
Standard packaging quantity (SPQ) 100	>SPQ	Standard	<SPQ	Sample

Handling instruction
Handling instructions for <i>flow 1</i> packages see vincotech.com website.

Package data
Package data for <i>flow 1</i> packages see vincotech.com website.

Vincotech thermistor reference
See Vincotech thermistor reference table at vincotech.com website.

UL recognition and file number
This device is certified according to UL 1557 standard, UL file number E192116. For more information see vincotech.com website. 

Document No.:	Date:	Modification:	Pages
10-FY07HVA075RG-L985F88-D1-14	29 Jan. 2021		
10-FY07HVA075RG-L985F88-D2-14	28 May. 2021	Merging Low- and High-side component IDs and Functions Update of Ordering Codes	

**DISCLAIMER**

The information, specifications, procedures, methods and recommendations herein (together "information") are presented by Vincotech to reader in good faith, are believed to be accurate and reliable, but may well be incomplete and/or not applicable to all conditions or situations that may exist or occur. Vincotech reserves the right to make any changes without further notice to any products to improve reliability, function or design. No representation, guarantee or warranty is made to reader as to the accuracy, reliability or completeness of said information or that the application or use of any of the same will avoid hazards, accidents, losses, damages or injury of any kind to persons or property or that the same will not infringe third parties rights or give desired results. It is reader's sole responsibility to test and determine the suitability of the information and the product for reader's intended use.

**LIFE SUPPORT POLICY**

Vincotech products are not authorised for use as critical components in life support devices or systems without the express written approval of Vincotech.

As used herein:

1. Life support devices or systems are devices or systems which, (a) are intended for surgical implant into the body, or (b) support or sustain life, or (c) whose failure to perform when properly used in accordance with instructions for use provided in labelling can be reasonably expected to result in significant injury to the user.
2. A critical component is any component of a life support device or system whose failure to perform can be reasonably expected to cause the failure of the life support device or system, or to affect its safety or effectiveness.