

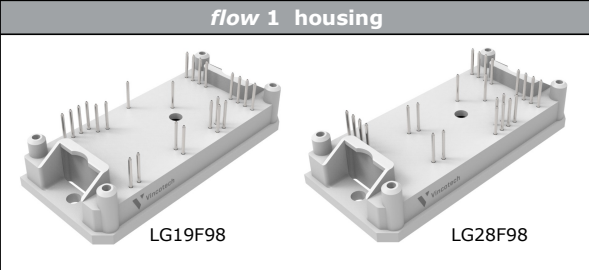
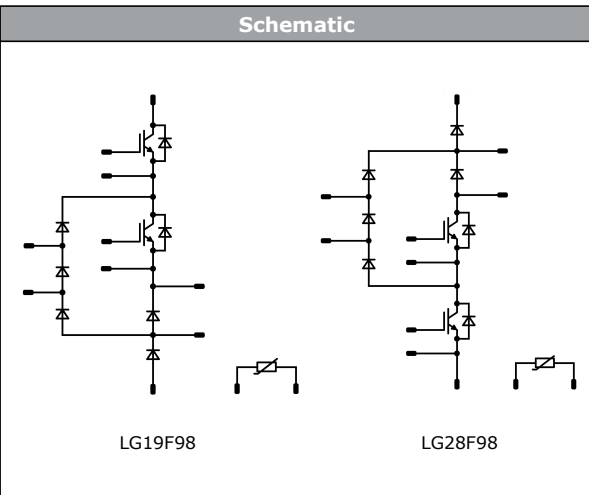

<i>flow</i> NPC 1 split	1500 V / 200 A
<div style="background-color: #eee; padding: 5px; margin-bottom: 10px;"><b>Features</b></div> <ul style="list-style-type: none"> <li>Enhanced efficiency</li> <li>Low inductive package</li> <li>Tandem diodes</li> <li>Enables 1500 V<sub>DC</sub></li> </ul> <div style="background-color: #eee; padding: 5px; margin-bottom: 10px;"><b>Target applications</b></div> <ul style="list-style-type: none"> <li>Solar Inverters</li> </ul> <div style="background-color: #eee; padding: 5px;"><b>Types</b></div> <ul style="list-style-type: none"> <li>10-F124NID200SH03-LG19F98</li> <li>10-F124NIE200SH03-LG29F98</li> </ul>	<div style="background-color: #eee; padding: 5px; margin-bottom: 10px;"><b>flow 1 housing</b></div> <div style="text-align: center;">  <p style="display: flex; justify-content: space-around; margin-top: 5px;"> <span>LG19F98</span> <span>LG28F98</span> </p> </div> <div style="background-color: #eee; padding: 5px; margin-bottom: 10px;"><b>Schematic</b></div> <div style="text-align: center;">  <p style="display: flex; justify-content: space-around; margin-top: 5px;"> <span>LG19F98</span> <span>LG28F98</span> </p> </div>

## Maximum Ratings

$T_j = 25\text{ °C}$ , unless otherwise specified

Parameter	Symbol	Condition	Value	Unit
<b>Buck Switch</b>				
Collector-emitter voltage	$V_{CES}$		1200	V
Collector current	$I_C$	$T_j = T_{jmax}$ $T_s = 80\text{ °C}$	147	A
Repetitive peak collector current	$I_{CRM}$	$t_p$ limited by $T_{jmax}$	600	A
Total power dissipation	$P_{tot}$	$T_j = T_{jmax}$ $T_s = 80\text{ °C}$	306	W
Gate-emitter voltage	$V_{GES}$		±20	V
Short circuit ratings	$t_{SC}$	$V_{GE} = 15\text{ V}$ $V_{CE} = 800\text{ V}$ $T_j = 150\text{ °C}$	10	μs
Maximum junction temperature	$T_{jmax}$		175	°C



Vincotech

## Maximum Ratings

$T_j = 25\text{ °C}$ , unless otherwise specified

Parameter	Symbol	Condition	Value	Unit
<b>Buck Diode</b>				
Peak repetitive reverse voltage	$V_{RRM}$		1300	V
Continuous (direct) forward current	$I_F$	$T_j = T_{jmax}$ $T_s = 80\text{ °C}$	128	A
Repetitive peak forward current	$I_{FRM}$		400	A
Total power dissipation	$P_{tot}$	$T_j = T_{jmax}$ $T_s = 80\text{ °C}$	317	W
Maximum junction temperature	$T_{jmax}$		175	°C
<b>Buck Sw. Protection Diode</b>				
Peak Repetitive Reverse Voltage	$V_{RRM}$		1200	V
Continuous (direct) forward current	$I_F$	$T_j = T_{jmax}$ $T_s = 80\text{ °C}$	57	A
Surge (non-repetitive) forward current	$I_{FSM}$	50 Hz Single Half Sine Wave $t_p = 10\text{ ms}$ $T_j = 150\text{ °C}$	430	A
Surge current capability	$P_{t}$		925	A <sup>2</sup> s
Total power dissipation	$P_{tot}$	$T_j = T_{jmax}$ $T_s = 80\text{ °C}$	109	W
Maximum Junction Temperature	$T_{jmax}$		175	°C
<b>Boost Switch</b>				
Collector-emitter voltage	$V_{CES}$		1200	V
Collector current	$I_C$		154	A
Repetitive peak collector current	$I_{CRM}$	$t_p$ limited by $T_{jmax}$	400	A
Total power dissipation	$P_{tot}$	$T_j = T_{jmax}$ $T_s = 80\text{ °C}$	247	W
Gate-emitter voltage	$V_{GES}$		±20	V
Maximum junction temperature	$T_{jmax}$		175	°C
<b>Boost Diode</b>				
Peak Repetitive Reverse Voltage	$V_{RRM}$		1200	V
Continuous (direct) forward current	$I_F$	$T_j = T_{jmax}$ $T_s = 80\text{ °C}$	57	A
Surge (non-repetitive) forward current	$I_{FSM}$	50 Hz Single Half Sine Wave $t_p = 10\text{ ms}$ $T_j = 150\text{ °C}$	430	A
Surge current capability	$P_{t}$		925	A <sup>2</sup> s
Total power dissipation	$P_{tot}$	$T_j = T_{jmax}$ $T_s = 80\text{ °C}$	109	W
Maximum Junction Temperature	$T_{jmax}$		175	°C



Vincotech

## Maximum Ratings

$T_j = 25\text{ °C}$ , unless otherwise specified

Parameter	Symbol	Condition	Value	Unit
<b>Boost Sw.Inv.Diode</b>				
Peak repetitive reverse voltage	$V_{RRM}$		1600	V
Continuous (direct) forward current	$I_F$		75	A
Surge (non-repetitive) forward current	$I_{FSM}$	50 Hz Single Half Sine Wave $t_p = 10\text{ ms}$	890	A
Surge current capability	$I^2t$	$T_j = 150\text{ °C}$	3960	A <sup>2</sup> s
Total power dissipation	$P_{tot}$	$T_j = T_{jmax}$ $T_s = 80\text{ °C}$	95	W
Maximum junction temperature	$T_{jmax}$		150	°C
<b>Boost Sw. Protection Diode</b>				
Peak repetitive reverse voltage	$V_{RRM}$		1600	V
Continuous (direct) forward current	$I_F$		75	A
Surge (non-repetitive) forward current	$I_{FSM}$	50 Hz Single Half Sine Wave $t_p = 10\text{ ms}$	890	A
Surge current capability	$I^2t$	$T_j = 150\text{ °C}$	3960	A <sup>2</sup> s
Total power dissipation	$P_{tot}$	$T_j = T_{jmax}$ $T_s = 80\text{ °C}$	95	W
Maximum junction temperature	$T_{jmax}$		150	°C
<b>Boost D. Protection Diode</b>				
Peak repetitive reverse voltage	$V_{RRM}$		1200	V
Continuous (direct) forward current	$I_F$	$T_j = T_{jmax}$ $T_s = 80\text{ °C}$	32	A
Surge (non-repetitive) forward current	$I_{FSM}$	50 Hz Single Half Sine Wave $t_p = 10\text{ ms}$	170	A
Surge current capability	$I^2t$	$T_j = 150\text{ °C}$	145	A <sup>2</sup> s
Total power dissipation	$P_{tot}$	$T_j = T_{jmax}$ $T_s = 80\text{ °C}$	71	W
Maximum junction temperature	$T_{jmax}$		175	°C



### Maximum Ratings

$T_j = 25\text{ °C}$ , unless otherwise specified

Parameter	Symbol	Condition	Value	Unit
-----------	--------	-----------	-------	------

#### Module Properties

##### Thermal Properties

Storage temperature	$T_{stg}$		-40...+125	°C
Operation temperature under switching condition	$T_{top}$		-40...(T <sub>max</sub> - 25)	°C

##### Isolation Properties

Isolation voltage	$V_{isol}$	DC Test Voltage* $t_p = 2\text{ s}$	6000	V
		AC Voltage $t_p = 1\text{ min}$	2500	V
Creepage distance			min. 12,7	mm
Clearance			min. 12,7	mm
Comparative Tracking Index	CTI		> 200	

\*100 % tested in production



Vincotech

**10-F124NID200SH03-LG19F98**  
**10-F124NIE200SH03-LG29F98**  
 datasheet

## Characteristic Values

Parameter	Symbol	Conditions					Value			Unit
		$V_{GS}$ [V]	$V_{GE}$ [V]	$V_{DS}$ [V]	$I_D$ [A]	$T_j$ [°C]	Min	Typ	Max	

### Buck Switch

#### Static

Parameter	Symbol	Conditions	$V_{GS}$ [V]	$V_{GE}$ [V]	$V_{DS}$ [V]	$I_D$ [A]	$T_j$ [°C]	Min	Typ	Max	Unit
Gate-emitter threshold voltage	$V_{GE(th)}$	$V_{GE} = V_{CE}$				0,0076	25	5,1	5,8	6,4	V
Collector-emitter saturation voltage	$V_{CEsat}$		15			200	25 125 150	1,78	1,99 2,29 2,37	2,42	V
Collector-emitter cut-off current	$I_{CES}$		0	1200			25			2,6	μA
Gate-emitter leakage current	$I_{GES}$		20	0			25			240	nA
Internal gate resistance	$r_g$								none		Ω
Input capacitance	$C_{ies}$	$f = 1 \text{ Mhz}$	0	25			25		12300		pF
Reverse transfer capacitance	$C_{res}$								690		
Gate charge	$Q_g$		15				25		1600		nC

#### Thermal

Parameter	Symbol	Conditions	$V_{GS}$ [V]	$V_{GE}$ [V]	$V_{DS}$ [V]	$I_D$ [A]	$T_j$ [°C]	Min	Typ	Max	Unit
Thermal resistance junction to sink	$R_{th(j-s)}$	$\lambda_{paste} = 3,4 \text{ W/mK}$ (PSX)							0,31		K/W

#### Dynamic\*

Parameter	Symbol	Conditions	$V_{GS}$ [V]	$V_{GE}$ [V]	$V_{DS}$ [V]	$I_D$ [A]	$T_j$ [°C]	Min	Typ	Max	Unit
Turn-on delay time	$t_{d(on)}$	$R_{gon} = 4 \Omega$ $R_{goff} = 4 \Omega$	±15	600		200	25		159		ns
Rise time	$t_r$							25	159		
Turn-off delay time	$t_{d(off)}$							125	26		
Fall time	$t_f$							150	28		
Turn-on energy (per pulse)	$E_{on}$							25	29		
Turn-off energy (per pulse)	$E_{off}$							125	248		
								150	305		
		150	315								
		25	28								
		125	55								
		150	64								
		25	9,72								
		125	12,47								
		150	13,46								
		25	6,64								
		125	11,26								
		150	12,53								

\* Values are given with the measurement circuit on page 25



### Characteristic Values

Parameter	Symbol	Conditions					Value			Unit
		$V_{GE}$ [V] $V_{GS}$ [V]	$V_{CE}$ [V] $V_{DS}$ [V]	$I_C$ [A] $I_D$ [A]	$I_F$ [A]	$T_j$ [°C]	Min	Typ	Max	

#### Buck Diode

##### Static

Forward voltage	$V_F$				200	25 125 150		3,36 3,14 3,04	3,54	V
Reverse leakage current	$I_R$			650		25			10,6	μA

##### Thermal

Thermal resistance junction to sink	$R_{th(j-s)}$	$\lambda_{paste} = 3,4$ W/mK (PSX)						0,30		K/W
-------------------------------------	---------------	---------------------------------------	--	--	--	--	--	------	--	-----

##### Dynamic\*

Peak recovery current	$I_{RRM}$					25 125 150		114 166 178		A
Reverse recovery time	$t_{rr}$					25 125 150		82 112 126		ns
Recovered charge	$Q_r$	$di/dt = 7960$ A/μs $di/dt = 7739$ A/μs $di/dt = 7503$ A/μs	±15	600	200	25 125 150		5,03 10,61 12,39		μC
Reverse recovered energy	$E_{rec}$					25 125 150		1,42 3,38 4,01		mWs
Peak rate of fall of recovery current	$(di_{rr}/dt)_{max}$					25 125 150		3849 1256 1375		A/μs

\* Values are given with the measurement circuit on page 25

#### Buck Sw. Protection Diode

##### Static

Forward voltage	$V_F$				75	25 150		2,16 2,24	2,49	V
Reverse leakage current	$I_r$			1200		25 150			120 14000	μA

##### Thermal

Thermal resistance junction to sink	$R_{th(j-s)}$	$\lambda_{paste} = 3,4$ W/mK (PSX)						0,87		K/W
-------------------------------------	---------------	---------------------------------------	--	--	--	--	--	------	--	-----



## Characteristic Values

Parameter	Symbol	Conditions					Value			Unit
		$V_{GS}$ [V]	$V_{GE}$ [V]	$V_{DS}$ [V]	$I_C$ [A]	$T_j$ [°C]	Min	Typ	Max	

### Boost Switch

#### Static

Parameter	Symbol	$V_{GS}$ [V]	$V_{GE}$ [V]	$V_{DS}$ [V]	$I_C$ [A]	$T_j$ [°C]	Min	Typ	Max	Unit
Gate-emitter threshold voltage	$V_{GE(th)}$		10		0,02	25	5,4	6	6,6	V
Collector-emitter saturation voltage	$V_{CESat}$	15			200	25 125 150		1,53 1,70 1,75	1,85	V
Collector-emitter cut-off current	$I_{CES}$	0		1200		25			200	μA
Gate-emitter leakage current	$I_{GES}$	20	0			25			1000	nA
Internal gate resistance	$r_g$							none		Ω
Input capacitance	$C_{ies}$							42000		pF
Output capacitance	$C_{oes}$	0		10		25		1400		
Reverse transfer capacitance	$C_{res}$							560		
Gate charge	$Q_g$	15		600	200	25		1400		nC

#### Thermal

Parameter	Symbol	Value	Unit
Thermal resistance junction to sink	$R_{th(j-s)}$	$\lambda_{paste} = 3,4$ W/mK (PSX)	K/W

#### Dynamic\*

Parameter	Symbol	$V_{GS}$ [V]	$V_{GE}$ [V]	$V_{DS}$ [V]	$I_C$ [A]	$T_j$ [°C]	Min	Typ	Max	Unit
Turn-on delay time	$t_{d(on)}$					25 125 150		642 630 626		ns
Rise time	$t_r$					25 125 150		97 110 114		
Turn-off delay time	$t_{d(off)}$					25 125 150		454 485 495		
Fall time	$t_f$					25 125 150		79 107 121		
Turn-on energy (per pulse)	$E_{on}$					25 125 150		25,512 32,545 35,643		
Turn-off energy (per pulse)	$E_{off}$					25 125 150		12,871 17,623 19,323		

\* Values are given with the measurement circuit on page 31



## Characteristic Values

Parameter	Symbol	Conditions					Value			Unit
		$V_{GE}$ [V]	$V_{CE}$ [V]	$I_C$ [A]	$T_j$ [°C]	Min	Typ	Max		

### Boost Diode

#### Static

Parameter	Symbol	$V_{GS}$ [V]	$V_{DS}$ [V]	$I_D$ [A]	$T_j$ [°C]	Min	Typ	Max	Unit
Forward voltage	$V_F$			75	25 150		2,16 2,24	2,49	V
Reverse leakage current	$I_r$		1200		25 150			120 14000	$\mu$ A

#### Thermal

Parameter	Symbol	$\lambda_{paste}$ (PSX)	Min	Typ	Max	Unit
Thermal resistance junction to sink	$R_{th(j-s)}$	$\lambda_{paste} = 3,4$ W/mK (PSX)				0,87 K/W

#### Dynamic\*

Parameter	Symbol	$dI/dt$	$\pm$	$I_C$	$I_D$	$T_j$ [°C]	Min	Typ	Max	Unit
Peak recovery current	$I_{RRM}$					25 125 150		58 77 84		A
Reverse recovery time	$t_{rr}$					25 125 150		396 587 670		ns
Recovered charge	$Q_r$	$dI/dt = 739$ A/ $\mu$ s $dI/dt = 968$ A/ $\mu$ s $dI/dt = 1147$ A/ $\mu$ s	$\pm 15$	600	200	25 125 150		8,801 19,433 23,921		$\mu$ C
Reverse recovered energy	$E_{rec}$					25 125 150		2,962 6,978 8,630		mWs
Peak rate of fall of recovery current	$(di_{rf}/dt)_{max}$					25 125 150		262 137 168		A/ $\mu$ s

\* Values are given with the measurement circuit on page 31

### Boost Sw.Inv.Diode

#### Static

Parameter	Symbol	$V_{GS}$ [V]	$V_{DS}$ [V]	$I_D$ [A]	$T_j$ [°C]	Min	Typ	Max	Unit
Forward voltage	$V_F$			75	25 125		1,10 1,04		V
Reverse leakage current	$I_R$		1600		25			50	$\mu$ A

#### Thermal

Parameter	Symbol	$\lambda_{paste}$ (PSX)	Min	Typ	Max	Unit
Thermal resistance junction to sink	$R_{th(j-s)}$	$\lambda_{paste} = 3,4$ W/mK (PSX)				0,74 K/W

### Boost Sw. Protection Diode

#### Static

Parameter	Symbol	$V_{GS}$ [V]	$V_{DS}$ [V]	$I_D$ [A]	$T_j$ [°C]	Min	Typ	Max	Unit
Forward voltage	$V_F$			75	25 125		1,10 1,04		V
Reverse leakage current	$I_R$		1600		25			50	$\mu$ A

#### Thermal

Parameter	Symbol	$\lambda_{paste}$ (PSX)	Min	Typ	Max	Unit
Thermal resistance junction to sink	$R_{th(j-s)}$	$\lambda_{paste} = 3,4$ W/mK (PSX)				0,74 K/W





Vincotech

**10-F124NID200SH03-LG19F98**  
**10-F124NIE200SH03-LG29F98**  
 datasheet

## Characteristic Values

Parameter	Symbol	Conditions					Value			Unit
		$V_{GE}$ [V] $V_{GS}$ [V]	$V_{CE}$ [V] $V_{DS}$ [V]	$I_C$ [A] $I_D$ [A]	$I_F$ [A]	$T_j$ [°C]	Min	Typ	Max	

### Boost D. Protection Diode

#### Static

Forward voltage	$V_F$				35	25 150		2,37 2,35	2,62	V
Reverse leakage current	$I_R$			1200		25 150			60 5500	$\mu$ A

#### Thermal

Thermal resistance junction to sink	$R_{th(j-s)}$	$\lambda_{paste} = 3,4$ W/mK (PSX)						1,34		K/W
-------------------------------------	---------------	---------------------------------------	--	--	--	--	--	------	--	-----

### Thermistor

Rated resistance	$R$					25		22		k $\Omega$
Deviation of $R_{100}$	$\Delta_{R/R}$	$R_{100} = 1484 \Omega$				100	-5		5	%
Power dissipation	$P$					25		5		mW
Power dissipation constant						25		1,5		mW/K
B-value	$B_{(25/50)}$	Tol. $\pm 1$ %				25		3962		K
B-value	$B_{(25/100)}$	Tol. $\pm 1$ %				25		4000		K
Vincotech NTC Reference									I	



### Buck Switch Characteristics

**figure 1. IGBT**

Typical output characteristics

$I_C = f(V_{CE})$

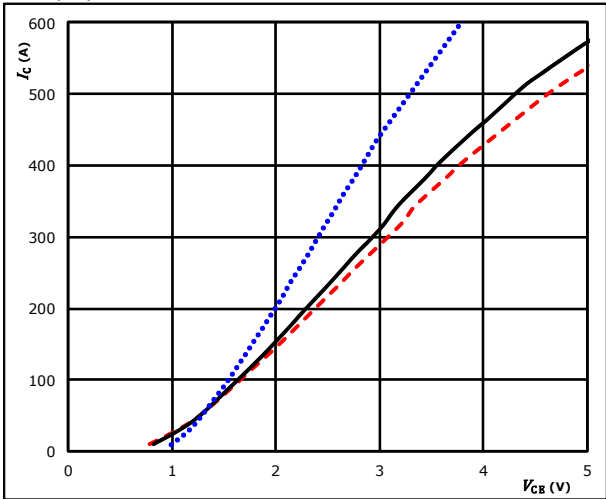

$t_p = 250 \mu s$        $T_j: 25 \text{ }^\circ C$       .....  
 $V_{GE} = 15 \text{ V}$        $T_j: 125 \text{ }^\circ C$       ———  
                           $T_j: 150 \text{ }^\circ C$       - - - -

**figure 2. IGBT**

Typical output characteristics

$I_C = f(V_{CE})$

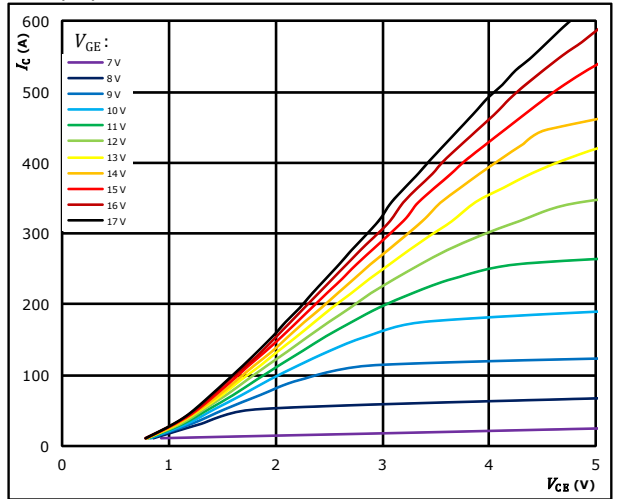

$t_p = 250 \mu s$   
 $T_j = 150 \text{ }^\circ C$   
 $V_{GE}$  from 7 V to 17 V in steps of 1 V

**figure 3. IGBT**

Typical transfer characteristics

$I_C = f(V_{GE})$

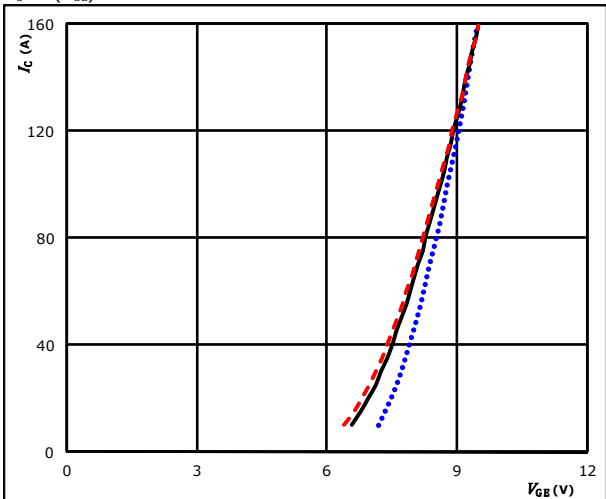

$t_p = 100 \mu s$        $T_j: 25 \text{ }^\circ C$       .....  
 $V_{CE} = 10 \text{ V}$        $T_j: 125 \text{ }^\circ C$       ———  
                           $T_j: 150 \text{ }^\circ C$       - - - -

**figure 4. IGBT**

Transient thermal impedance as function of pulse duration

$Z_{th(j-s)} = f(t_p)$

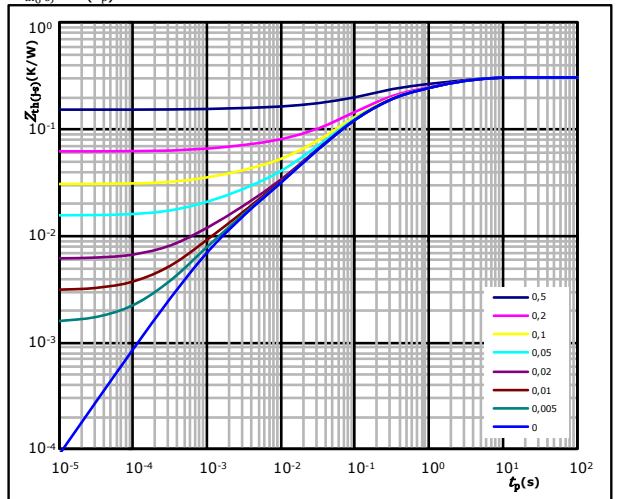

$D = t_p / T$   
 $R_{th(j-s)} = 0,31 \text{ K/W}$

IGBT thermal model values

R (K/W)	$\tau$ (s)
9,35E-02	2,07E+00
7,50E-02	3,51E-01
1,16E-01	9,41E-02
1,89E-02	1,25E-02
7,76E-03	1,26E-03



Vincotech

**10-F124NID200SH03-LG19F98**  
**10-F124NIE200SH03-LG29F98**  
datasheet

## Buck Switch Characteristics

**figure 5.** IGBT

Safe operating area

$$I_C = f(V_{CE})$$

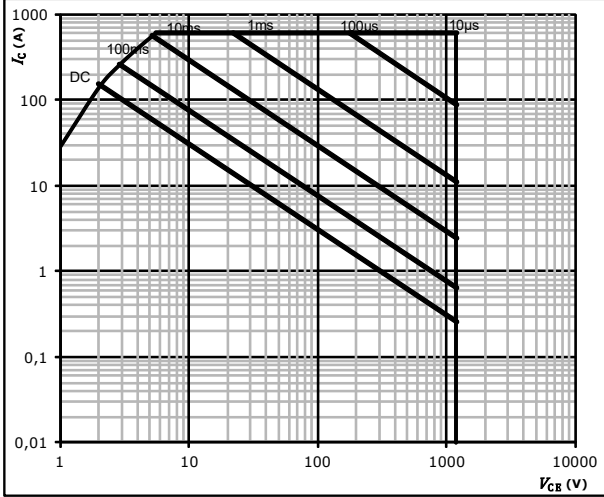

$D =$  single pulse  
 $T_s =$  80 °C  
 $V_{GE} =$  ±15 V  
 $T_j = T_{jmax}$



### Buck Diode Characteristics

**figure 1.** FWD

Typical forward characteristics

$$I_F = f(V_F)$$

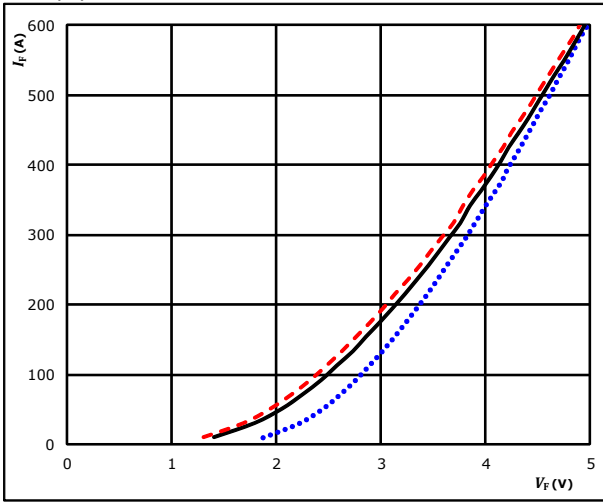

$t_p = 250 \mu s$   
 $T_j:$  25 °C .....  
 125 °C ———  
 150 °C - - - -

**figure 2.** FWD

Transient thermal impedance as a function of pulse width

$$Z_{th(j-s)} = f(t_p)$$

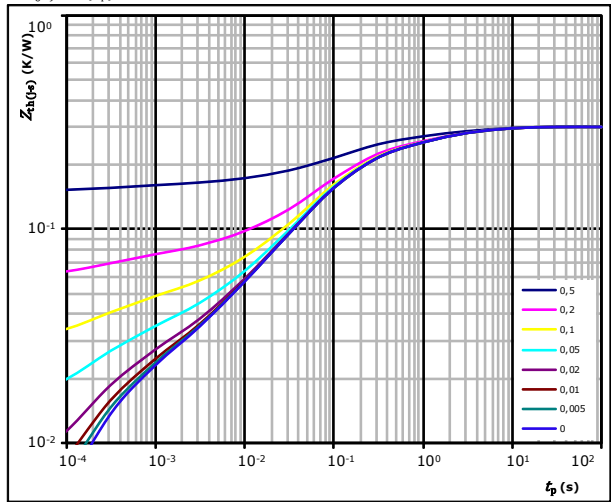

$D = t_p / T$   
 $R_{th(j-s)} = 0,30 \text{ K/W}$

FWD thermal model values

$R$ (K/W)	$\tau$ (s)
2,63E-02	5,38E+00
5,41E-02	1,20E+00
9,07E-02	1,90E-01
8,31E-02	5,93E-02
2,35E-02	8,54E-03
8,59E-03	1,18E-03
1,38E-02	2,37E-04



## Buck Sw. Protection Diode Characteristics

**figure 1.** Prot. Diode  
**Typical forward characteristics**

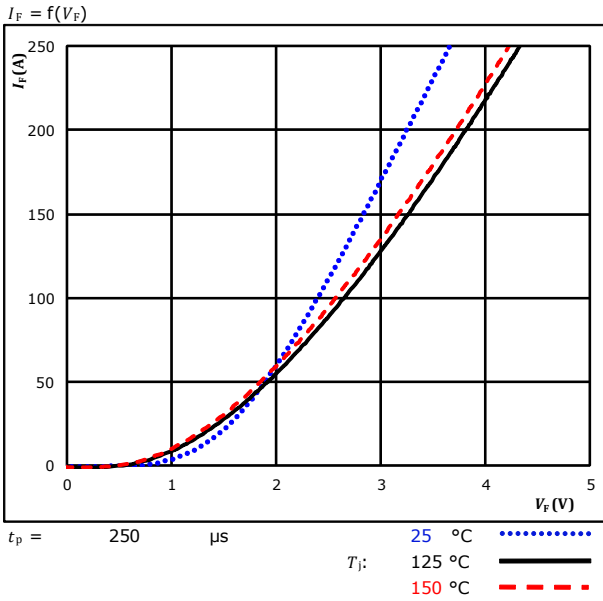

**figure 2.** Prot. Diode  
**Transient thermal impedance as a function of pulse width**

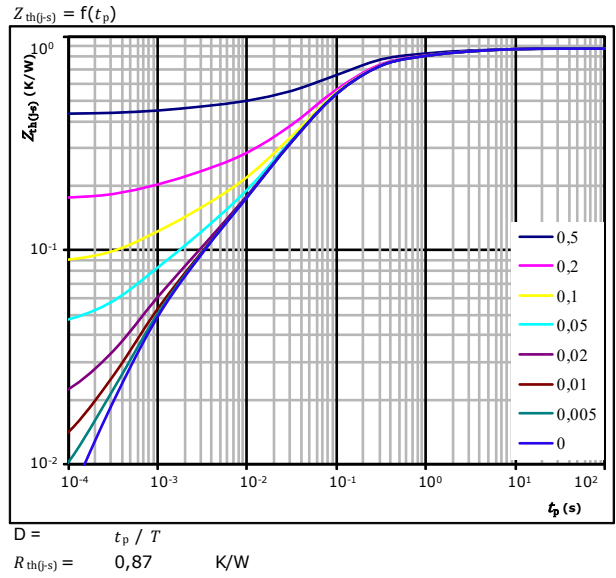

Prot. Diode thermal model values

$R$ (K/W)	$\tau$ (s)
5,30E-02	3,91E+00
1,18E-01	6,14E-01
4,44E-01	1,10E-01
1,61E-01	2,86E-02
5,06E-02	5,08E-03
4,44E-02	8,90E-04



### Boost Switch Characteristics

**figure 1.** IGBT

Typical output characteristics

$I_C = f(V_{CE})$

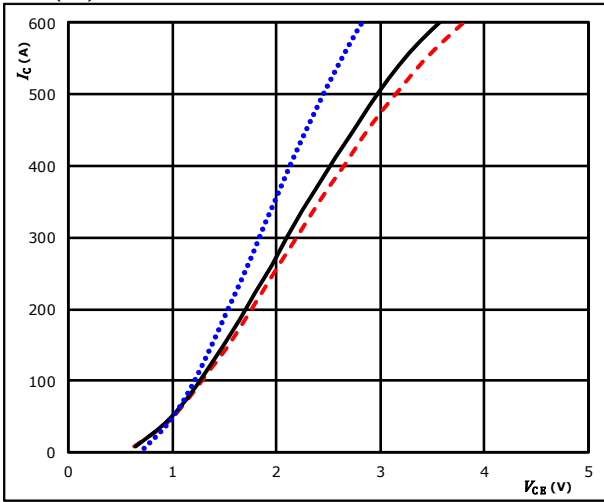

$t_p = 250 \mu s$   $T_j: 25 \text{ }^\circ C$  .....  
 $V_{GE} = 15 V$   $T_j: 125 \text{ }^\circ C$  ———  
 $T_j: 150 \text{ }^\circ C$  - - - - -

**figure 2.** IGBT

Typical output characteristics

$I_C = f(V_{CE})$

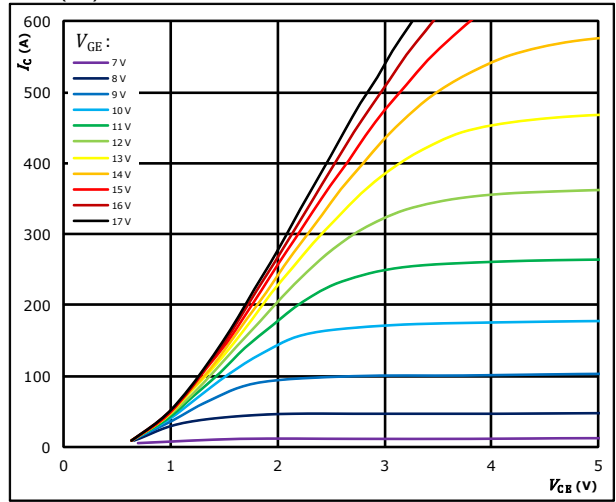

$t_p = 250 \mu s$   
 $T_j = 150 \text{ }^\circ C$   
 $V_{GE}$  from 7 V to 17 V in steps of 1 V

**figure 3.** IGBT

Typical transfer characteristics

$I_C = f(V_{GE})$

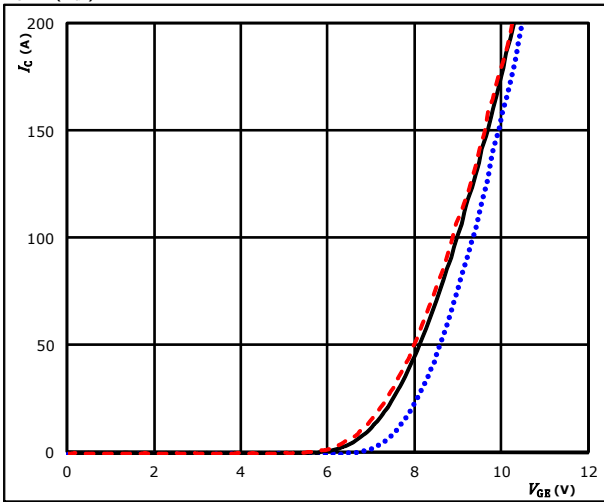

$t_p = 100 \mu s$   $T_j: 25 \text{ }^\circ C$  .....  
 $V_{CE} = 10 V$   $T_j: 125 \text{ }^\circ C$  ———  
 $T_j: 150 \text{ }^\circ C$  - - - - -

**figure 4.** IGBT

Transient thermal impedance as function of pulse duration

$Z_{th(j-s)} = f(t_p)$

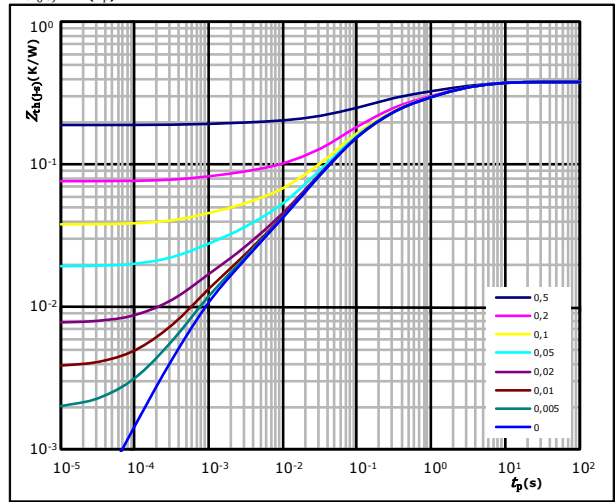

$D = t_p / T$   
 $R_{th(j-s)} = 0,38 \text{ K/W}$

IGBT thermal model values

R (K/W)	$\tau$ (s)
5,41E-02	4,17E+00
9,46E-02	1,11E+00
9,45E-02	2,29E-01
1,11E-01	6,87E-02
1,98E-02	1,02E-02
1,09E-02	9,51E-04



Vincotech

**10-F124NID200SH03-LG19F98**  
**10-F124NIE200SH03-LG29F98**  
datasheet

## Boost Switch Characteristics

**figure 5.** IGBT

Safe operating area

$$I_C = f(V_{CE})$$

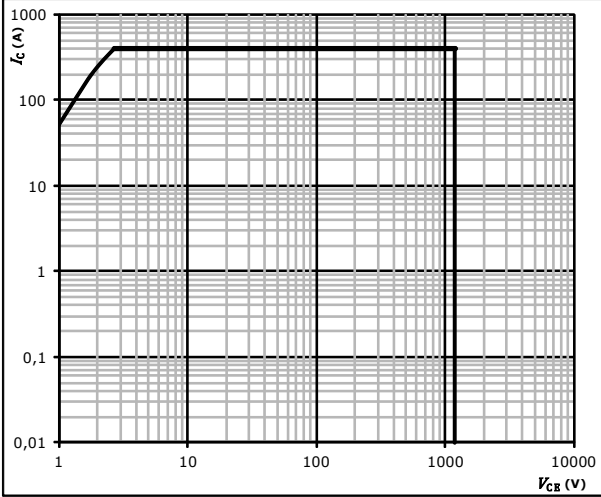

$D =$  single pulse  
 $T_s =$  80 °C  
 $V_{GE} =$  ±15 V  
 $T_j =$   $T_{jmax}$



### Boost Diode Characteristics

**figure 1.** FWD  
**Typical forward characteristics**

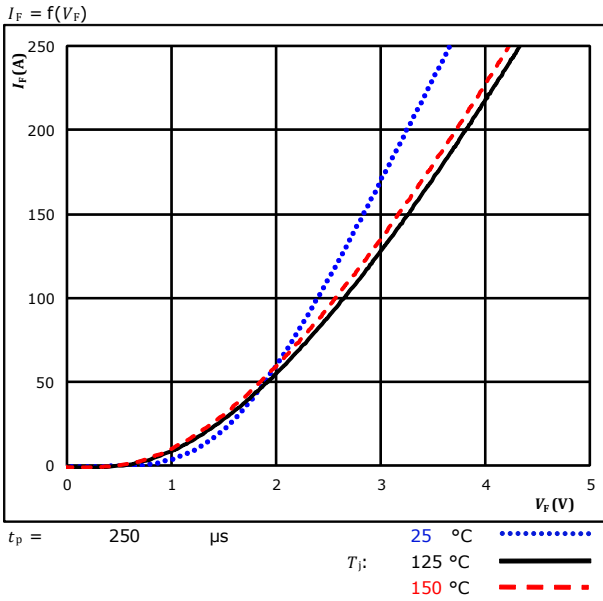

**figure 2.** FWD  
**Transient thermal impedance as a function of pulse width**

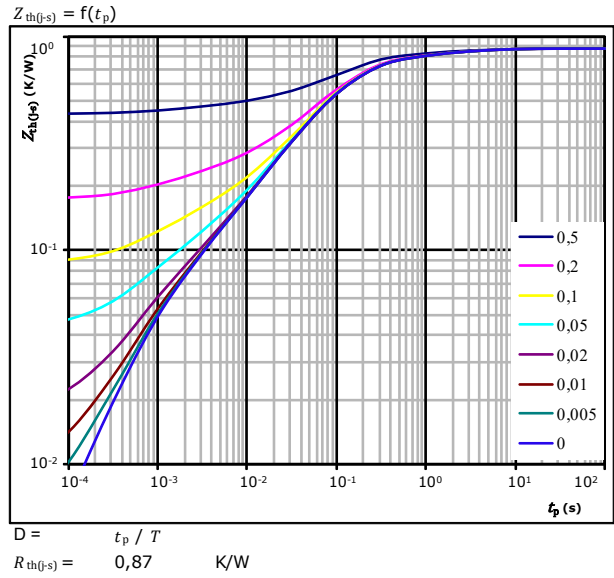

FWD thermal model values

$R$ (K/W)	$\tau$ (s)
5,30E-02	3,91E+00
1,18E-01	6,14E-01
4,44E-01	1,10E-01
1,61E-01	2,86E-02
5,06E-02	5,08E-03
4,44E-02	8,90E-04





### Boost Sw.Inv.Diode Characteristics

**figure 1.** Prot. Diode

Typical forward characteristics

$$I_F = f(V_F)$$

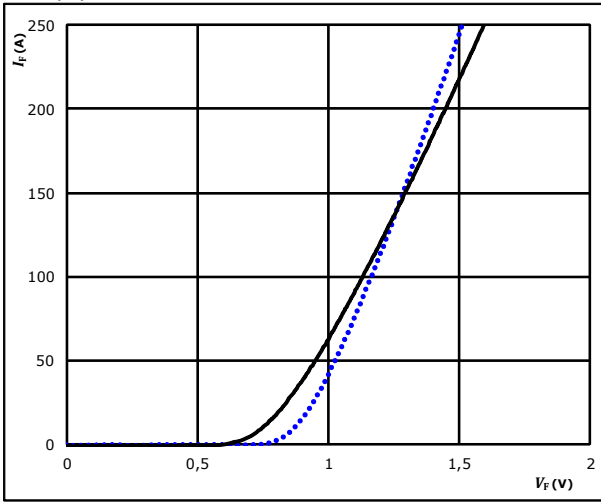

$t_p = 250 \mu s$   $T_j: 25 \text{ }^\circ\text{C}$  (dotted blue line)  $125 \text{ }^\circ\text{C}$  (solid black line)

**figure 2.** Prot. Diode

Transient thermal impedance as a function of pulse width

$$Z_{th(j-s)} = f(t_p)$$

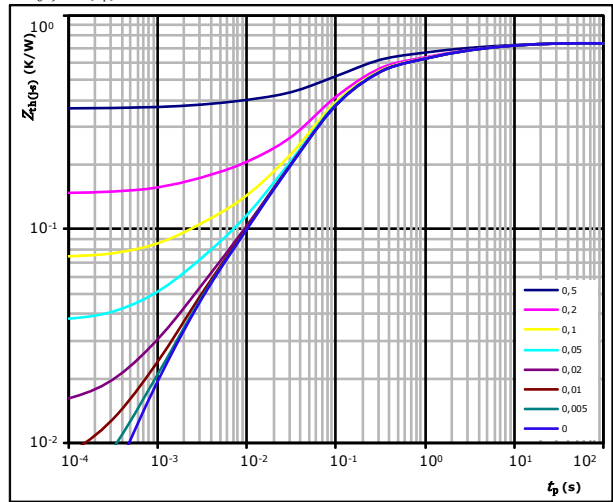

$D = t_p / T$   
 $R_{th(j-s)} = 0,74 \text{ K/W}$

Prot. Diode thermal model values

$R$ (K/W)	$\tau$ (s)
6,95E-02	7,08E+00
1,21E-01	1,15E+00
2,75E-01	1,52E-01
2,24E-01	5,48E-02
3,60E-02	4,07E-03
1,01E-02	1,33E-03



## Boost Sw. Protection Diode Characteristics

**figure 1.** Prot. Diode

Typical forward characteristics

$$I_F = f(V_F)$$

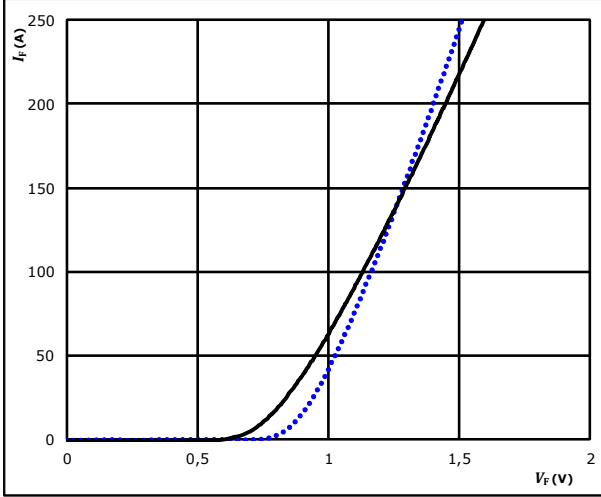

$t_p = 250 \mu s$   $T_j: 25 \text{ } ^\circ\text{C}$  (dotted blue line)  
 $125 \text{ } ^\circ\text{C}$  (solid black line)

**figure 2.** Prot. Diode

Transient thermal impedance as a function of pulse width

$$Z_{th(j-s)} = f(t_p)$$

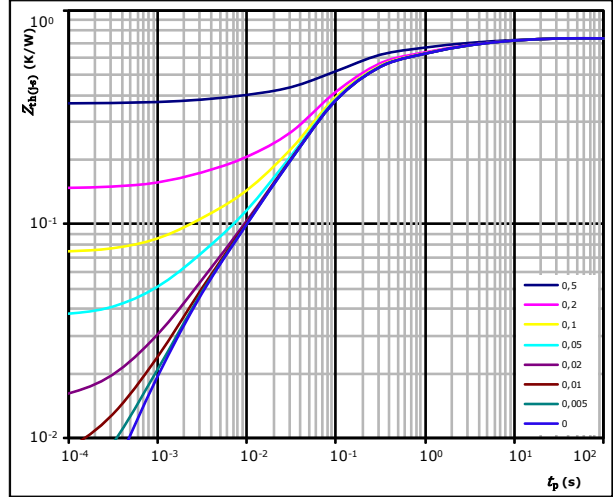

$D = t_p / T$   
 $R_{th(j-s)} = 0,74 \text{ K/W}$

Prot. Diode thermal model values

$R$ (K/W)	$\tau$ (s)
6,95E-02	7,08E+00
1,21E-01	1,15E+00
2,75E-01	1,52E-01
2,24E-01	5,48E-02
3,60E-02	4,07E-03
1,01E-02	1,33E-03



## Boost D. Protection Diode Characteristics

**figure 1. Prot. Diode**

Typical forward characteristics

$$I_F = f(V_F)$$

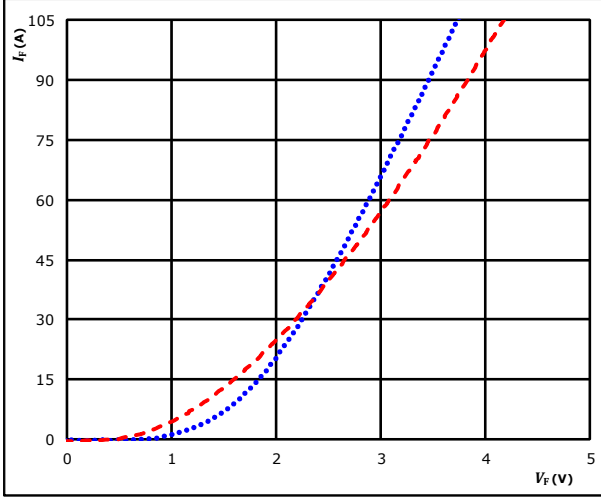

$t_p = 250 \mu s$   
 $T_j: 25 \text{ }^\circ\text{C}$  (blue dotted line)  
 $150 \text{ }^\circ\text{C}$  (red dashed line)

**figure 2. Prot. Diode**

Transient thermal impedance as a function of pulse width

$$Z_{th(j-s)} = f(t_p)$$

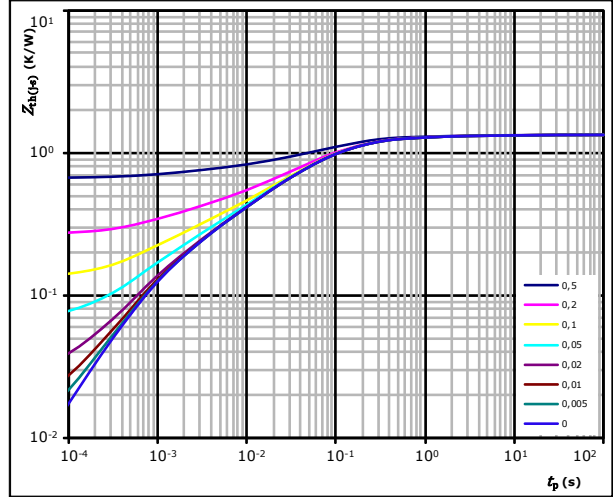

$D = t_p / T$   
 $R_{th(j-s)} = 1,34 \text{ K/W}$   
 Prot. Diode thermal model values

$R \text{ (K/W)}$	$\tau \text{ (s)}$
3,06E-02	9,16E+00
1,47E-01	6,10E-01
6,10E-01	8,89E-02
2,96E-01	2,14E-02
1,39E-01	5,05E-03
1,19E-01	9,19E-04

## Thermistor Characteristics

**figure 1. Thermistor**

Typical NTC characteristic as a function of temperature

$$R = f(T)$$

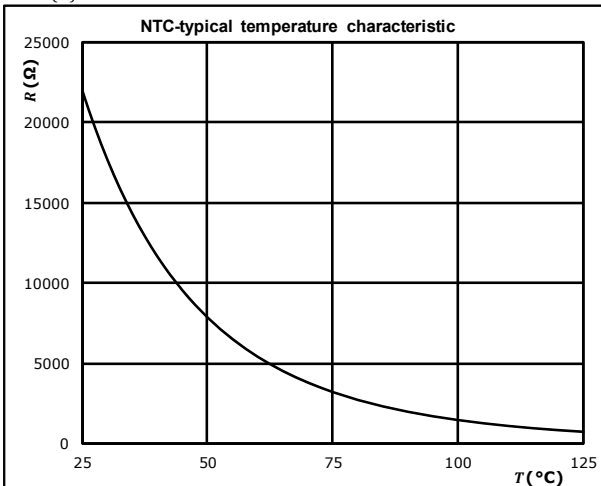



## Buck Switching Characteristics

**figure 1. IGBT**  
 Typical switching energy losses as a function of collector current

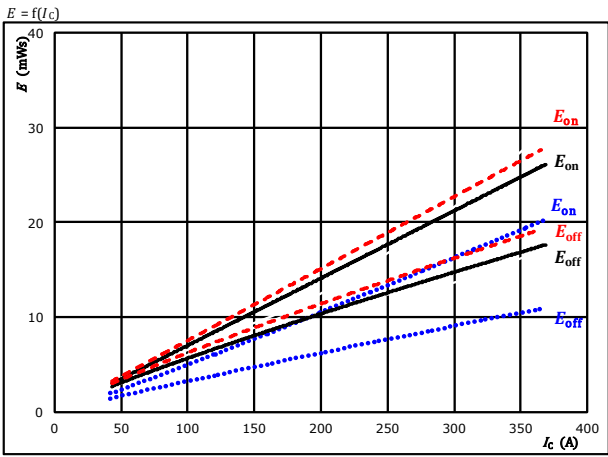

With an inductive load at  
 $V_{CE} = 600$  V  
 $V_{GE} = \pm 15$  V  
 $R_{gon} = 4$   $\Omega$   
 $R_{goff} = 4$   $\Omega$   
 $T_j: 25$  °C (blue dotted),  $125$  °C (black solid),  $150$  °C (red dashed)

**figure 2. IGBT**  
 Typical switching energy losses as a function of gate resistor

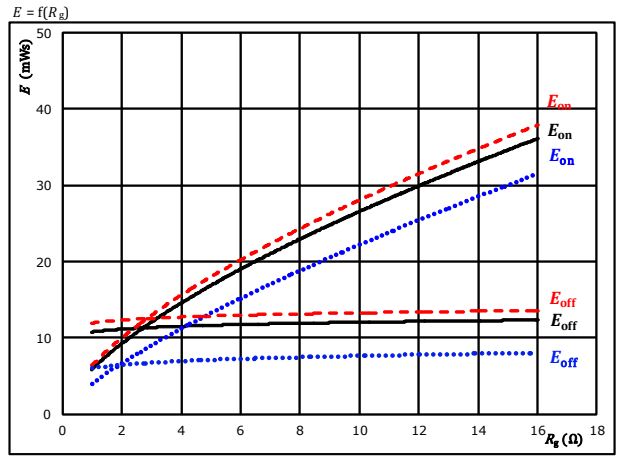

With an inductive load at  
 $V_{CE} = 600$  V  
 $V_{GE} = \pm 15$  V  
 $I_C = 200$  A  
 $T_j: 25$  °C (blue dotted),  $125$  °C (black solid),  $150$  °C (red dashed)

**figure 3. FWD**  
 Typical reverse recovered energy loss as a function of collector current

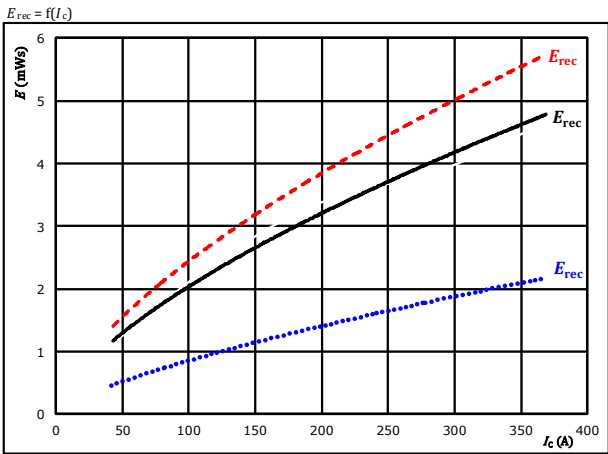

With an inductive load at  
 $V_{CE} = 600$  V  
 $V_{GE} = \pm 15$  V  
 $R_{gon} = 4$   $\Omega$   
 $T_j: 25$  °C (blue dotted),  $125$  °C (black solid),  $150$  °C (red dashed)

**figure 4. FWD**  
 Typical reverse recovered energy loss as a function of gate resistor

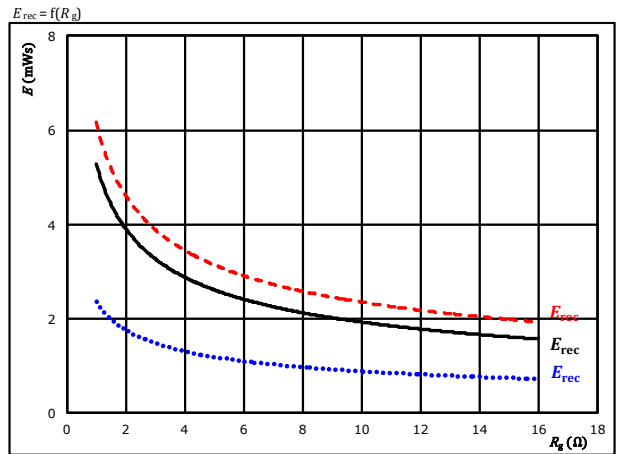

With an inductive load at  
 $V_{CE} = 600$  V  
 $V_{GE} = \pm 15$  V  
 $I_C = 200$  A  
 $T_j: 25$  °C (blue dotted),  $125$  °C (black solid),  $150$  °C (red dashed)



## Buck Switching Characteristics

**figure 5. IGBT**  
 Typical switching times as a function of collector current

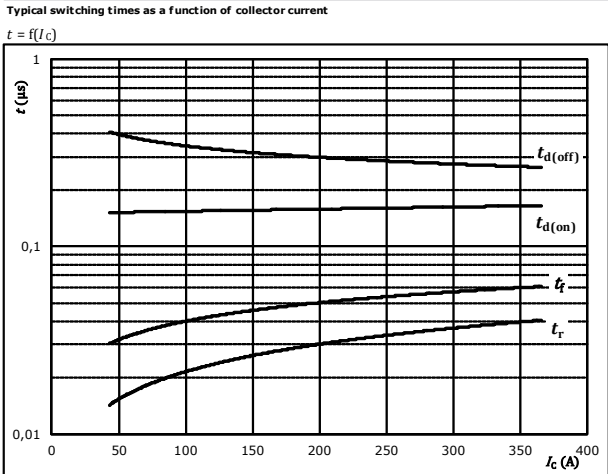

**figure 6. IGBT**  
 Typical switching times as a function of gate resistor

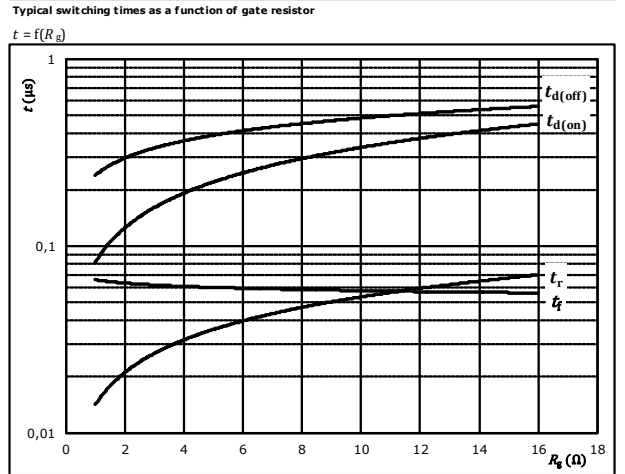

**figure 7. FWD**  
 Typical reverse recovery time as a function of collector current

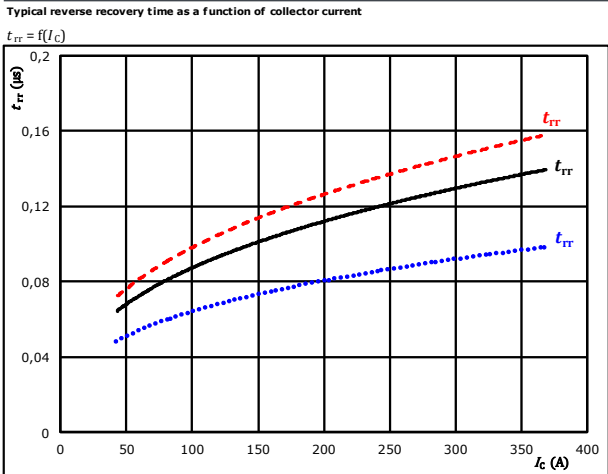

**figure 8. FWD**  
 Typical reverse recovery time as a function of IGBT turn on gate resistor

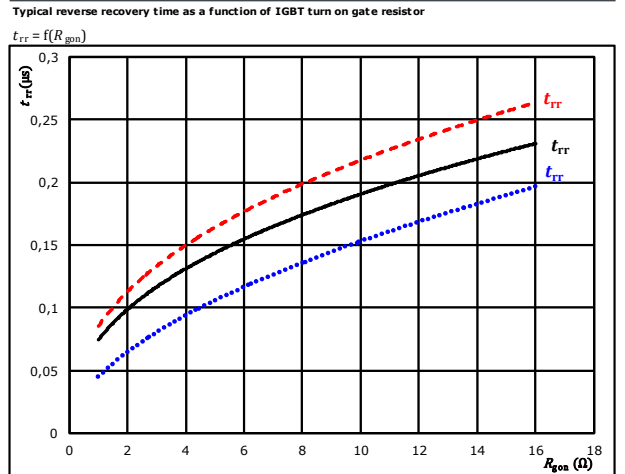



## Buck Switching Characteristics

**figure 9.** FWD

Typical recovered charge as a function of collector current

$$Q_r = f(I_c)$$

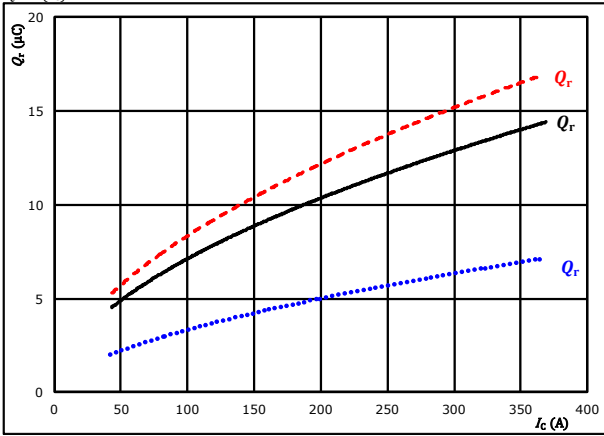

At  $V_{CE} = 600$  V  $T_j = 25$  °C (dotted blue)  
 $V_{GE} = \pm 15$  V  $T_j = 125$  °C (solid black)  
 $R_{gpn} = 4$  Ω  $T_j = 150$  °C (dashed red)

**figure 10.** FWD

Typical recovered charge as a function of IGBT turn on gate resistor

$$Q_r = f(R_{gpn})$$

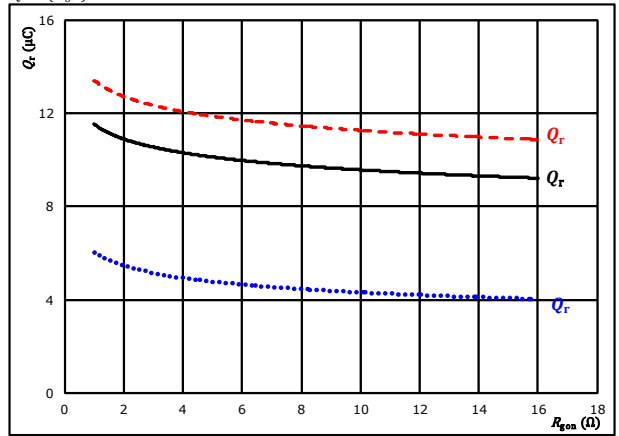

At  $V_{CE} = 600$  V  $T_j = 25$  °C (dotted blue)  
 $V_{GE} = \pm 15$  V  $T_j = 125$  °C (solid black)  
 $I_c = 200$  A  $T_j = 150$  °C (dashed red)

**figure 11.** FWD

Typical peak reverse recovery current current as a function of collector current

$$I_{RM} = f(I_c)$$

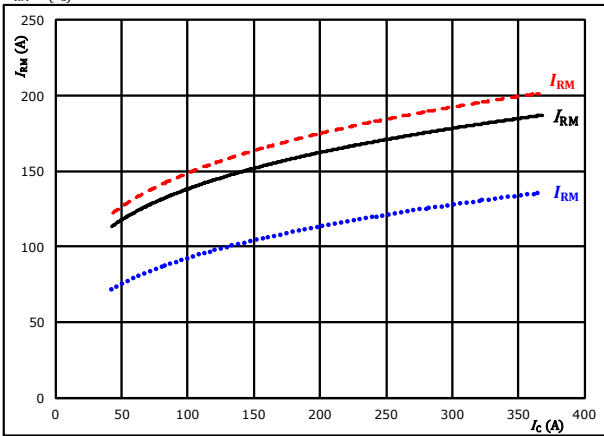

At  $V_{CE} = 600$  V  $T_j = 25$  °C (dotted blue)  
 $V_{GE} = \pm 15$  V  $T_j = 125$  °C (solid black)  
 $R_{gpn} = 4$  Ω  $T_j = 150$  °C (dashed red)

**figure 12.** FWD

Typical peak reverse recovery current current as a function of IGBT turn on gate resistor

$$I_{RM} = f(R_{gpn})$$

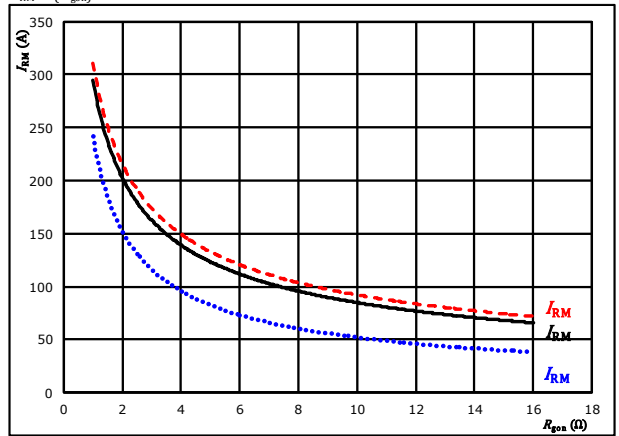

At  $V_{CE} = 600$  V  $T_j = 25$  °C (dotted blue)  
 $V_{GE} = \pm 15$  V  $T_j = 125$  °C (solid black)  
 $I_c = 200$  A  $T_j = 150$  °C (dashed red)



Vincotech

## Buck Switching Characteristics

**figure 13.** FWD

Typical rate of fall of forward and reverse recovery current as a function of collector current  
 $di_f/dt, di_{rr}/dt = f(I_c)$

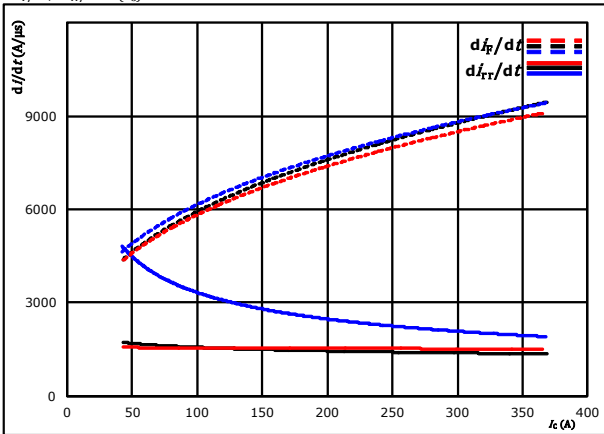

At  $V_{CE} = 600$  V  $T_j = 25$  °C  
 $V_{GE} = \pm 15$  V  $T_j = 125$  °C  
 $R_{g0n} = 4$  Ω  $T_j = 150$  °C

**figure 14.** FWD

Typical rate of fall of forward and reverse recovery current as a function of IGBT turn on gate resistor  
 $di_f/dt, di_{rr}/dt = f(R_{g0n})$

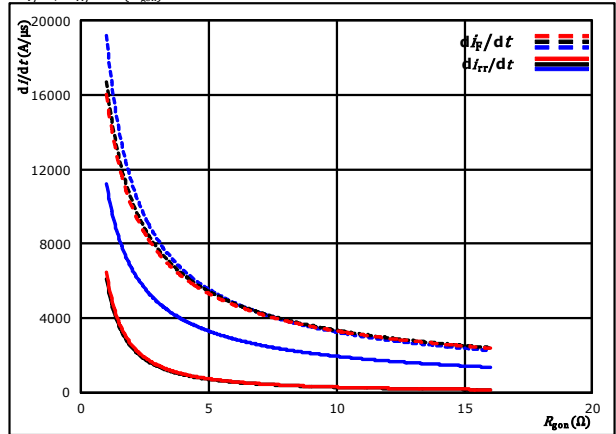

At  $V_{CE} = 600$  V  $T_j = 25$  °C  
 $V_{GE} = \pm 15$  V  $T_j = 125$  °C  
 $I_c = 200$  A  $T_j = 150$  °C

**figure 15.** IGBT

Reverse bias safe operating area  
 $I_c = f(V_{CE})$

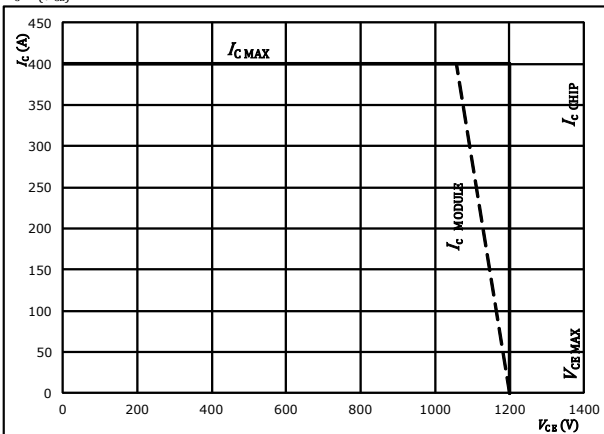

At  $T_j = 125$  °C  
 $R_{g0n} = 4$  Ω  
 $R_{g0ff} = 4$  Ω



## Buck Switching Definitions

**General conditions**

$T_j$	=	125 °C
$R_{g\text{on}}$	=	4 $\Omega$
$R_{g\text{off}}$	=	4 $\Omega$

**figure 1.** IGBT

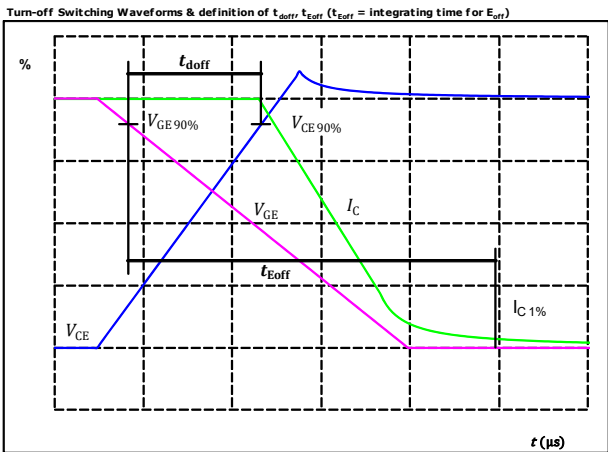

$V_{CE}(0\%) =$	-15	V
$V_{GE}(100\%) =$	15	V
$V_C(100\%) =$	600	V
$I_C(100\%) =$	200	A
$t_{\text{doff}} =$	305	ns

**figure 2.** IGBT

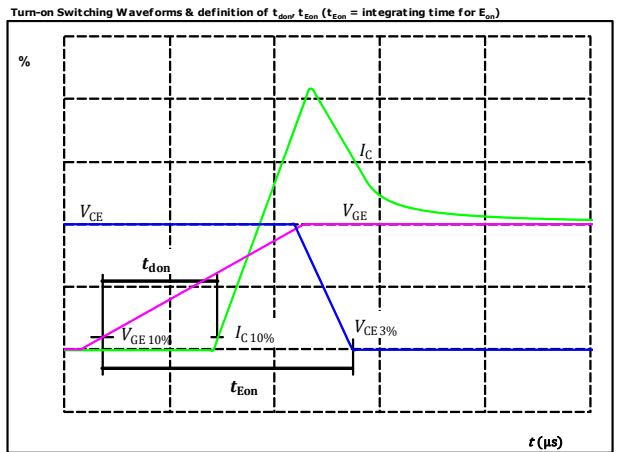

$V_{CE}(0\%) =$	-15	V
$V_{GE}(100\%) =$	15	V
$V_C(100\%) =$	600	V
$I_C(100\%) =$	200	A
$t_{\text{don}} =$	159	ns

**figure 3.** IGBT

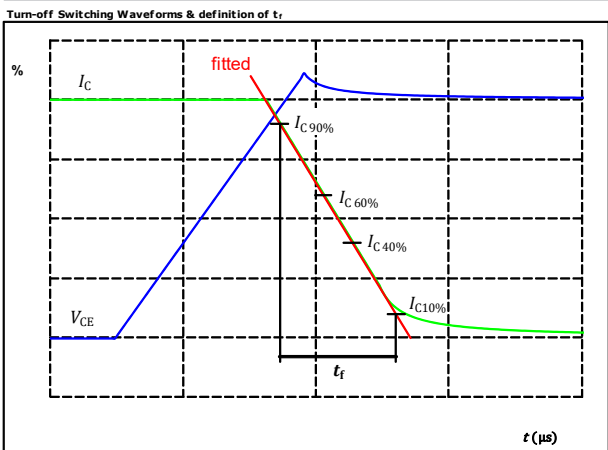

$V_C(100\%) =$	600	V
$I_C(100\%) =$	200	A
$t_r =$	55	ns

**figure 4.** IGBT

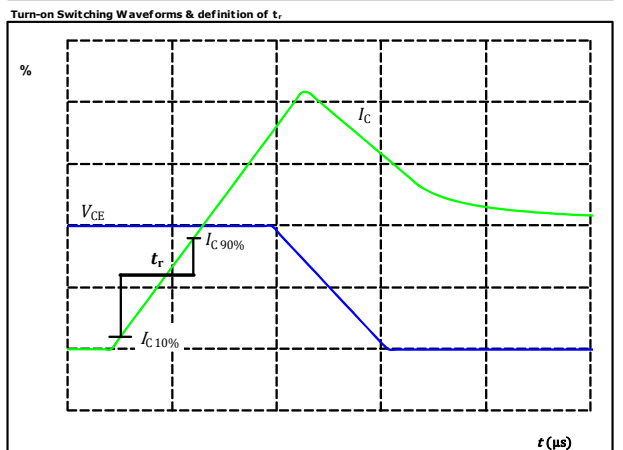

$V_C(100\%) =$	600	V
$I_C(100\%) =$	200	A
$t_r =$	28	ns





Vincotech

**10-F124NID200SH03-LG19F98**  
**10-F124NIE200SH03-LG29F98**  
 datasheet

## Buck Switching Characteristics

figure 5. FWD

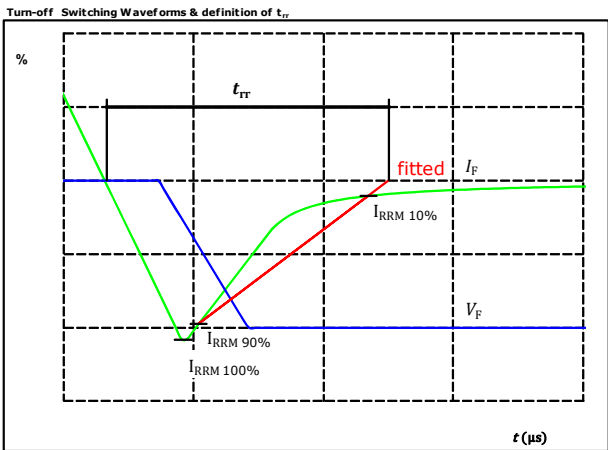

$V_F(100\%) =$	600	V
$I_F(100\%) =$	200	A
$I_{RRM}(100\%) =$	166	A
$t_{rr} =$	112	ns

figure 6. FWD

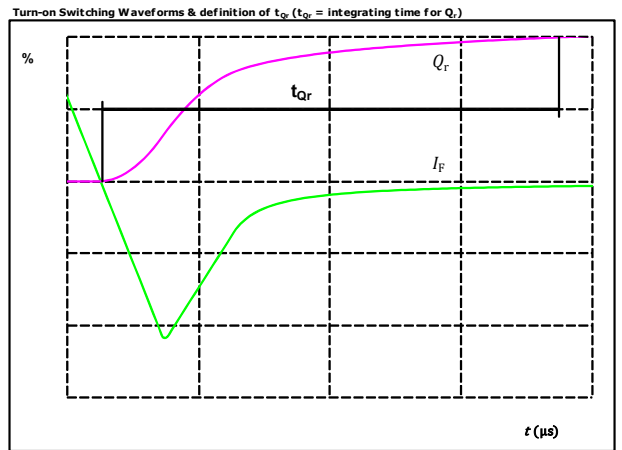

$I_F(100\%) =$	200	A
$Q_r(100\%) =$	10,61	$\mu$ C

## Buck Switching Measurement circuit

figure 1.

BUCK IGBT SW MEASUREMENT

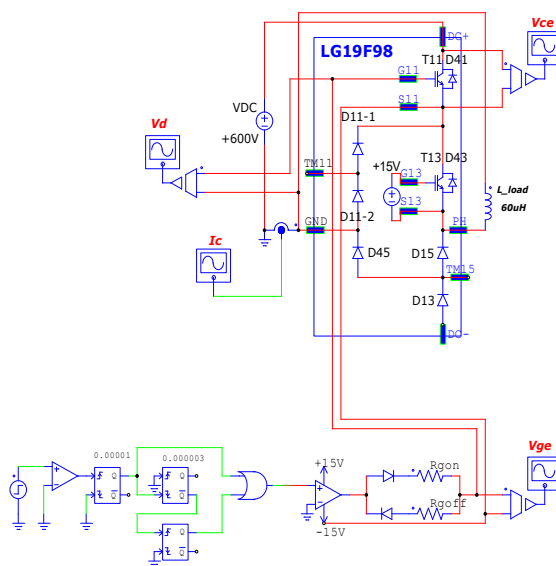



## Boost Switching Characteristics

**figure 1.** IGBT

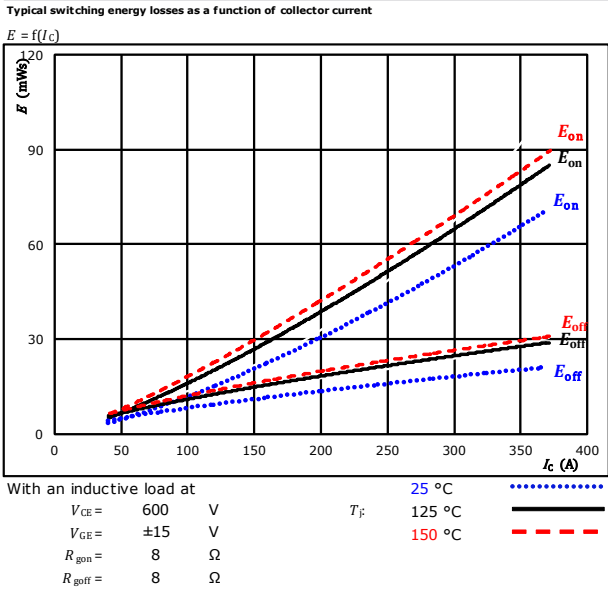

**figure 2.** IGBT

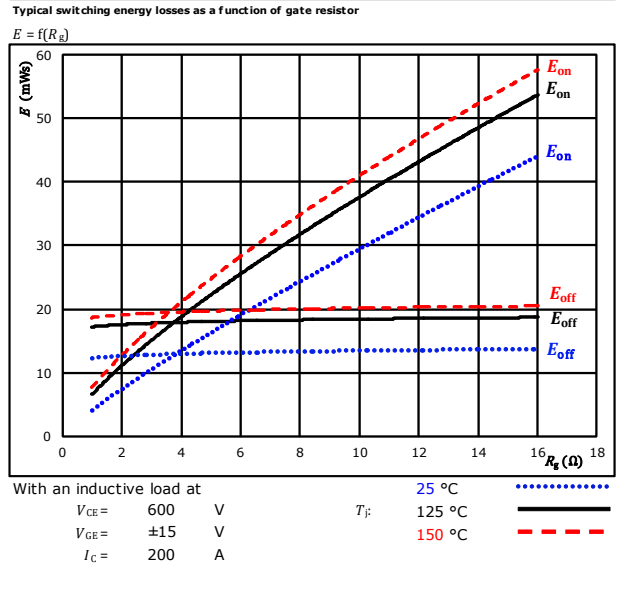

**figure 3.** FWD

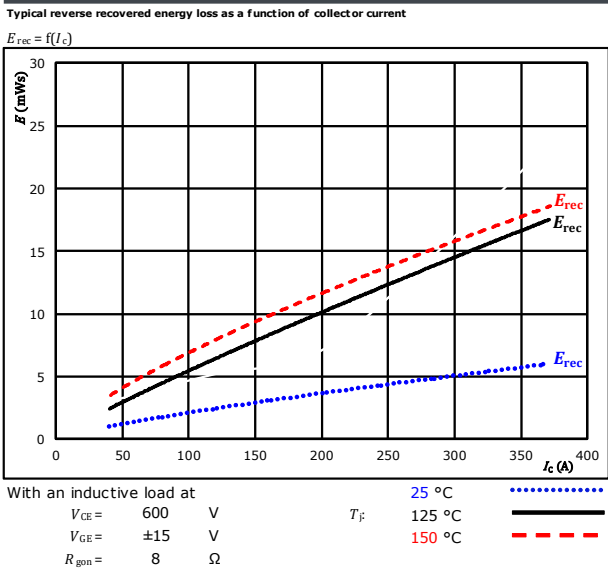

**figure 4.** FWD

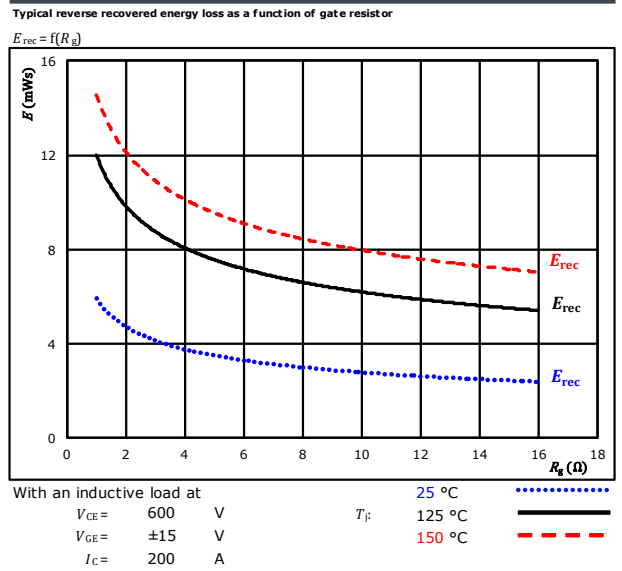



Vincotech

## Boost Switching Characteristics

**figure 5.** IGBT

Typical switching times as a function of collector current

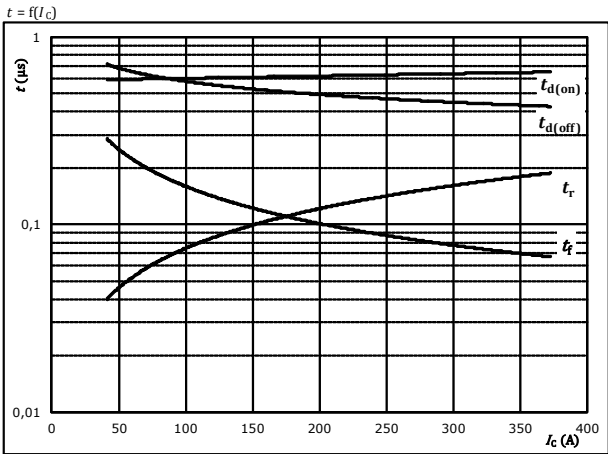

**figure 6.** IGBT

Typical switching times as a function of gate resistor

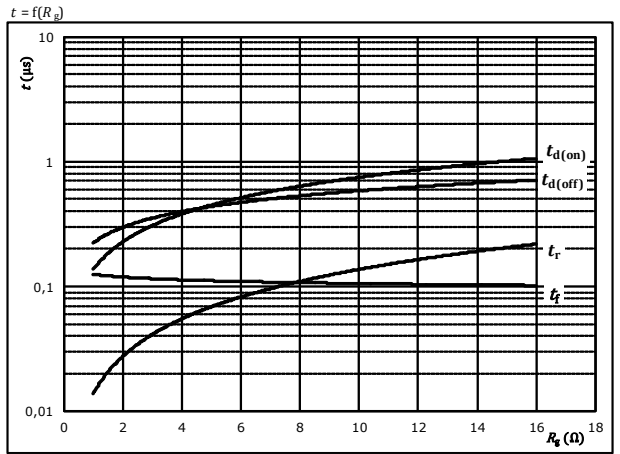

**figure 7.** FWD

Typical reverse recovery time as a function of collector current

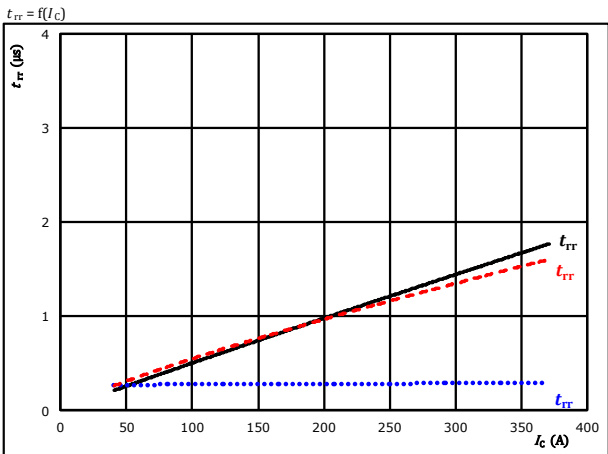

**figure 8.** FWD

Typical reverse recovery time as a function of IGBT turn on gate resistor

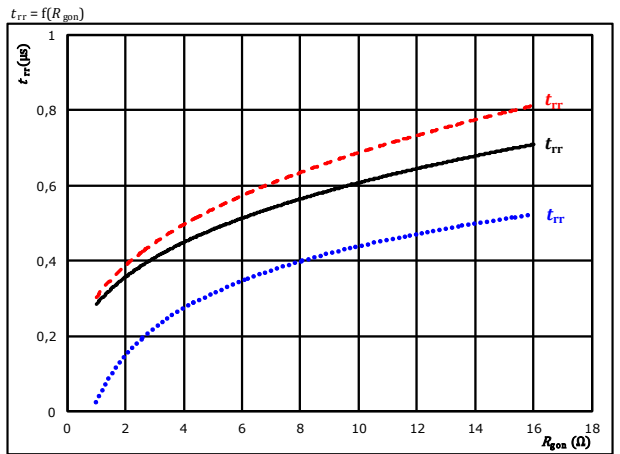



## Boost Switching Characteristics

**figure 9.** FWD

Typical recovered charge as a function of collector current

$$Q_r = f(I_c)$$

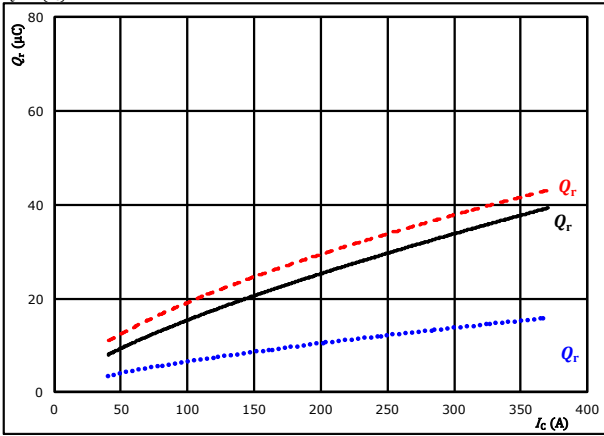

At  $V_{CE} = 600$  V  $T_j = 25$  °C  $V_{GE} = \pm 15$  V  $T_j = 125$  °C  $R_{gdn} = 8$   $\Omega$   $T_j = 150$  °C

**figure 10.** FWD

Typical recovered charge as a function of IGBT turn on gate resistor

$$Q_r = f(R_{gdn})$$

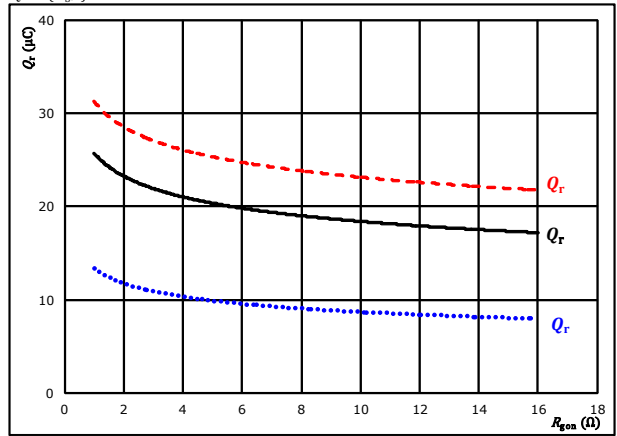

At  $V_{CE} = 600$  V  $T_j = 25$  °C  $V_{GE} = \pm 15$  V  $T_j = 125$  °C  $I_c = 200$  A  $T_j = 150$  °C

**figure 11.** FWD

Typical peak reverse recovery current as a function of collector current

$$I_{RM} = f(I_c)$$

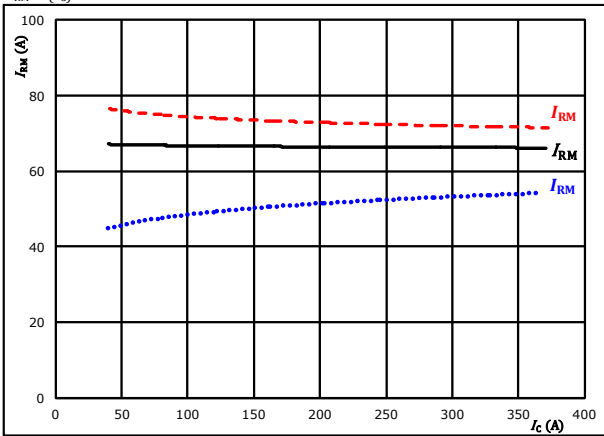

At  $V_{CE} = 600$  V  $T_j = 25$  °C  $V_{GE} = \pm 15$  V  $T_j = 125$  °C  $R_{gdn} = 8$   $\Omega$   $T_j = 150$  °C

**figure 12.** FWD

Typical peak reverse recovery current as a function of IGBT turn on gate resistor

$$I_{RM} = f(R_{gdn})$$

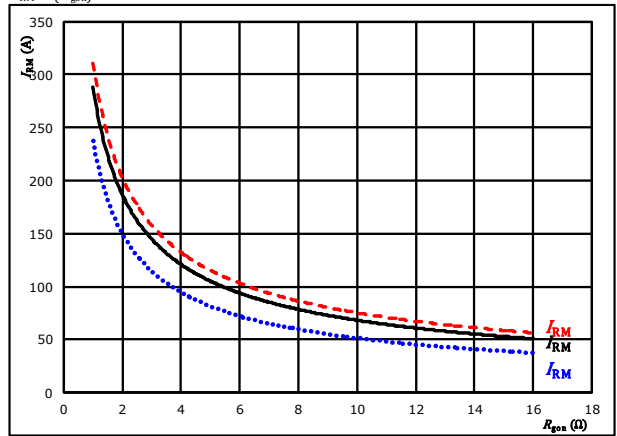

At  $V_{CE} = 600$  V  $T_j = 25$  °C  $V_{GE} = \pm 15$  V  $T_j = 125$  °C  $I_c = 200$  A  $T_j = 150$  °C



Vincotech

**10-F124NID200SH03-LG19F98**  
**10-F124NIE200SH03-LG29F98**  
 datasheet

## Boost Switching Characteristics

**figure 13.** FWD

Typical rate of fall of forward and reverse recovery current as a function of collector current  
 $di_f/dt, di_{rr}/dt = f(I_c)$

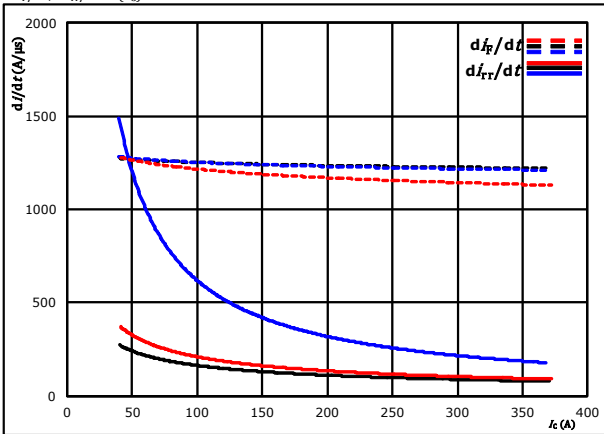

At  $V_{CE} = 600$  V  $T_j = 25$  °C  
 $V_{GE} = \pm 15$  V  $T_j = 125$  °C  
 $R_{\theta n} = 8$  Ω  $T_j = 150$  °C

**figure 14.** FWD

Typical rate of fall of forward and reverse recovery current as a function of IGBT turn on gate resistor  
 $di_f/dt, di_{rr}/dt = f(R_{\theta n})$

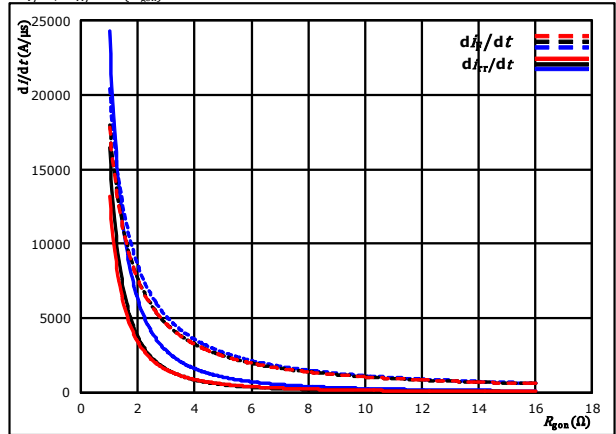

At  $V_{CE} = 600$  V  $T_j = 25$  °C  
 $V_{GE} = \pm 15$  V  $T_j = 125$  °C  
 $I_c = 200$  A  $T_j = 150$  °C

**figure 15.** IGBT

Reverse bias safe operating area  
 $I_c = f(V_{CE})$

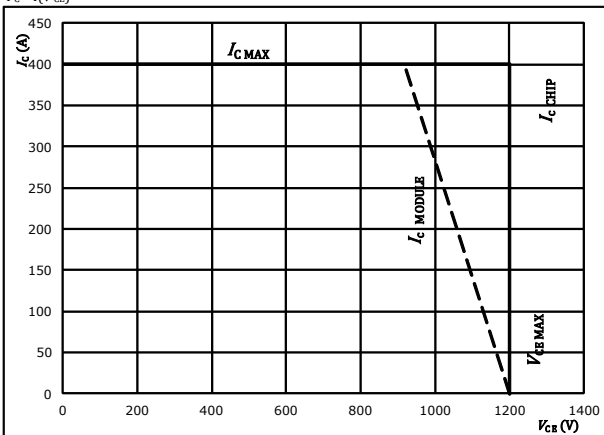

At  $T_j = 125$  °C  
 $R_{\theta n} = 8$  Ω  
 $R_{\theta ff} = 8$  Ω



## Boost Switching Definitions

**General conditions**

$T_j$	=	125 °C
$R_{g\text{on}}$	=	8 $\Omega$
$R_{g\text{off}}$	=	8 $\Omega$

**figure 1.** IGBT  
 Turn-off Switching Waveforms & definition of  $t_{\text{doff}}$ ,  $t_{\text{Eoff}}$  ( $t_{\text{Eoff}}$  = integrating time for  $E_{\text{off}}$ )

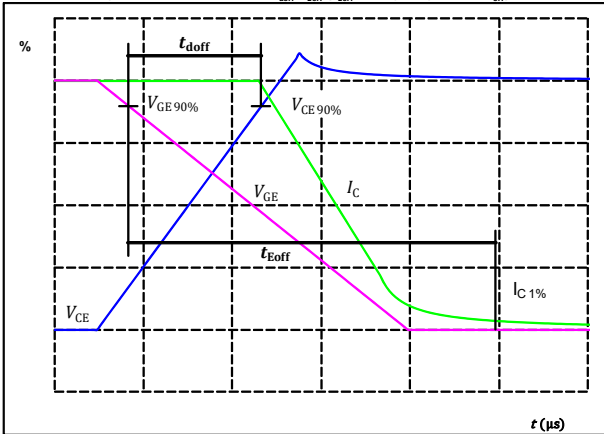

$V_{CE}(0\%) =$	-15	V
$V_{GE}(100\%) =$	15	V
$V_C(100\%) =$	600	V
$I_C(100\%) =$	200	A
$t_{\text{doff}} =$	485	ns

**figure 2.** IGBT  
 Turn-on Switching Waveforms & definition of  $t_{\text{don}}$ ,  $t_{\text{Eon}}$  ( $t_{\text{Eon}}$  = integrating time for  $E_{\text{on}}$ )

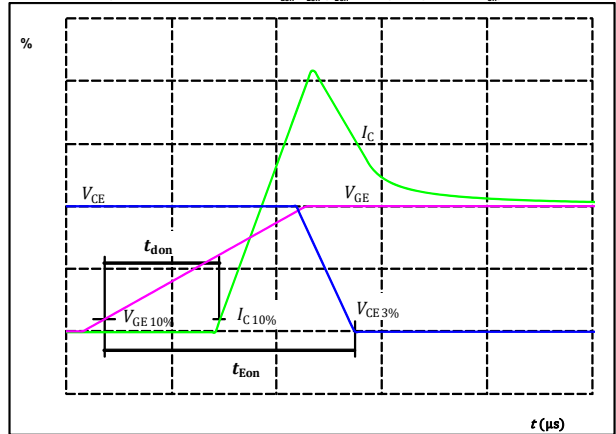

$V_{CE}(0\%) =$	-15	V
$V_{GE}(100\%) =$	15	V
$V_C(100\%) =$	600	V
$I_C(100\%) =$	200	A
$t_{\text{don}} =$	630	ns

**figure 3.** IGBT  
 Turn-off Switching Waveforms & definition of  $t_r$

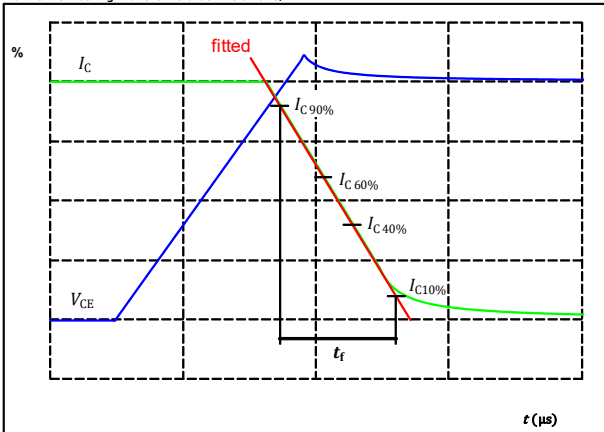

$V_C(100\%) =$	600	V
$I_C(100\%) =$	200	A
$t_r =$	107	ns

**figure 4.** IGBT  
 Turn-on Switching Waveforms & definition of  $t_r$

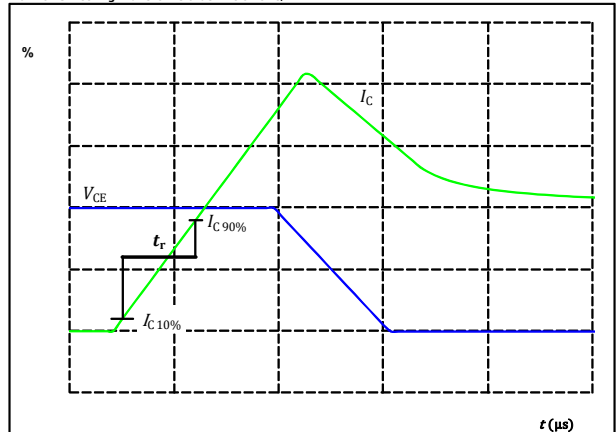

$V_C(100\%) =$	600	V
$I_C(100\%) =$	200	A
$t_r =$	110	ns



Vincotech

**10-F124NID200SH03-LG19F98**  
**10-F124NIE200SH03-LG29F98**  
 datasheet

## Boost Switching Characteristics

figure 5. FWD

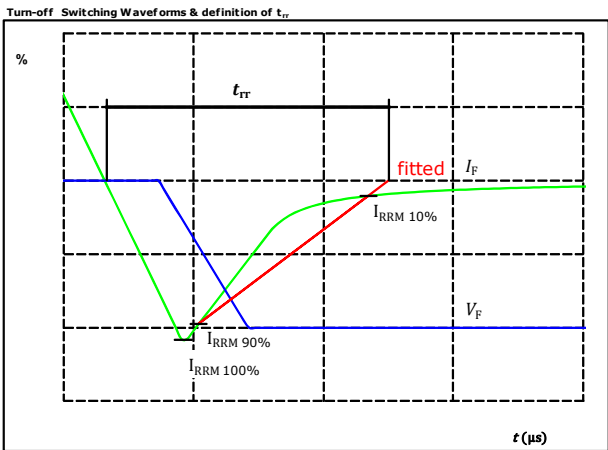

$V_F(100\%) =$	600	V
$I_F(100\%) =$	200	A
$I_{RRM}(100\%) =$	77	A
$t_{rr} =$	587	ns

figure 6. FWD

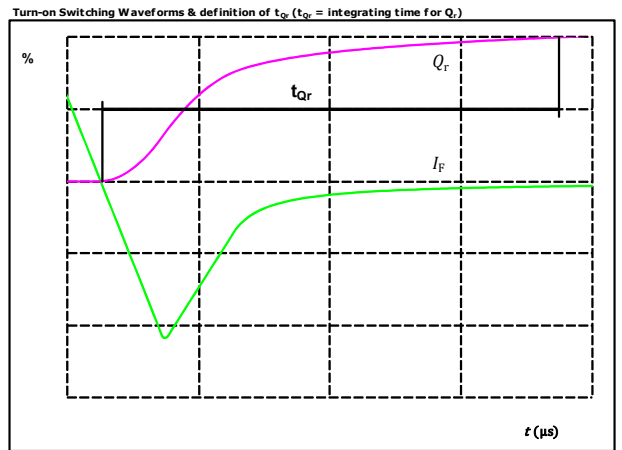

$I_F(100\%) =$	200	A
$Q_r(100\%) =$	19,43	$\mu\text{C}$

## Boost Switching Measurement circuit

figure 1.

### BOOST IGBT SW MEASUREMENT

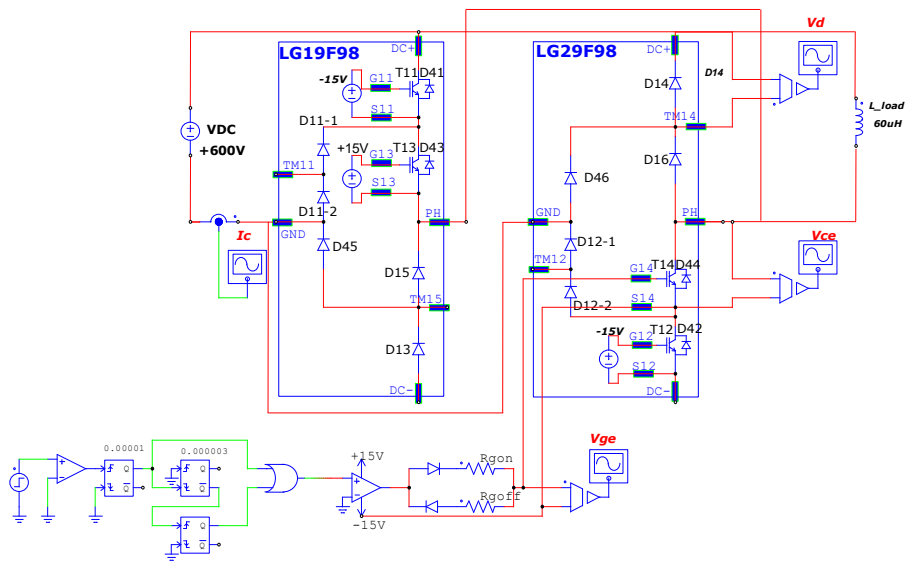



**10-F124NID200SH03-LG19F98**  
**10-F124NIE200SH03-LG29F98**  
 datasheet

Vincotech

Ordering Code & Marking						
<b>Version</b>			<b>Ordering Code</b>			
without thermal paste 17 mm housing with solder pins			10-F124NID200SH03-LG19F98			
with thermal paste 17 mm housing with solder pins			10-F124NID200SH03-LG19F98-/3/			
NN-NNNNNNNNNNNN TTTTIV WWYY UL VIN LLLL SSSS						
<b>Text</b>	<b>Name</b>		<b>Date code</b>	<b>UL &amp; VIN</b>	<b>Lot</b>	<b>Serial</b>
	NN-NNNNNNNNNNNN-TTTTIV		WWYY	UL VIN	LLLL	SSSS
<b>Datamatrix</b>	<b>Type&amp;Ver</b>	<b>Lot number</b>	<b>Serial</b>	<b>Date code</b>		
	TTTTIV	LLLL	SSSS	WWYY		

**High Side Module 10-F124NID200SH03-LG19F98**

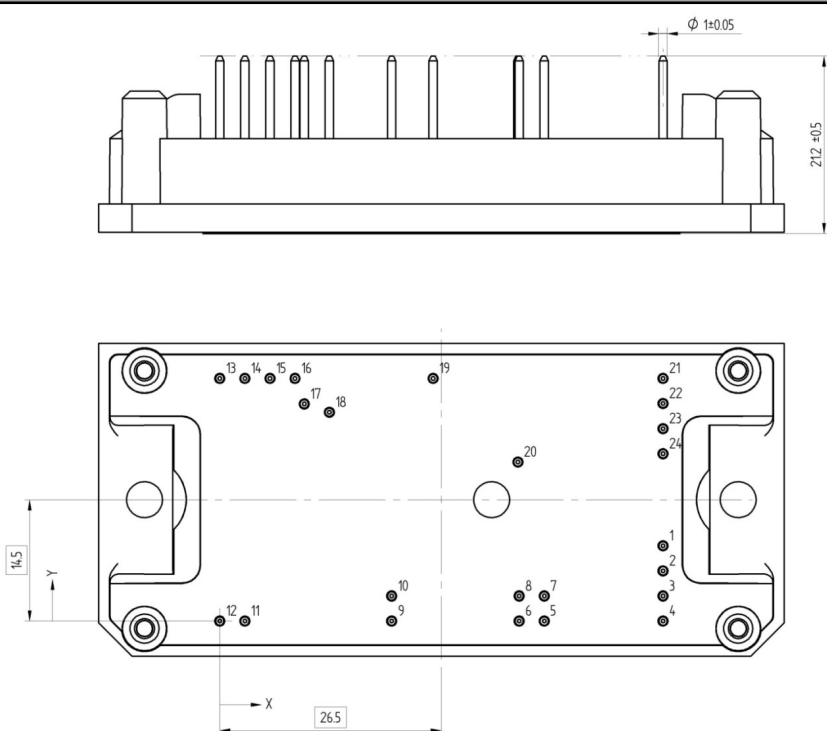
Pin table				Outline	
Pin	X	Y	Function		
1	53	9	GND		
2	53	6	GND		
3	53	3	GND		
4	53	0	GND		
5	38,8	0	DC+		
6	35,8	0	DC+		
7	38,8	3	DC+		
8	35,8	3	DC+		
9	20,55	0	G11		
10	20,55	3	S11		
11	3	0	Therm1		
12	0	0	Therm2		
13	0	29	Ph		
14	3	29	Ph		
15	6	29	Ph		
16	9	29	Ph		
17	10,1	25,95	S13		
18	13,1	24,95	G13		
19	25,5	29	TM15		
20	35,65	19	TM11		
21	53	29	DC-		
22	53	26	DC-		
23	53	23	DC-		
24	53	20	DC-		

Tolerance of pinpositions: ±0.5mm at the end of pins  
 Dimension of coordinate axis is only offset without tolerance





Vincotech

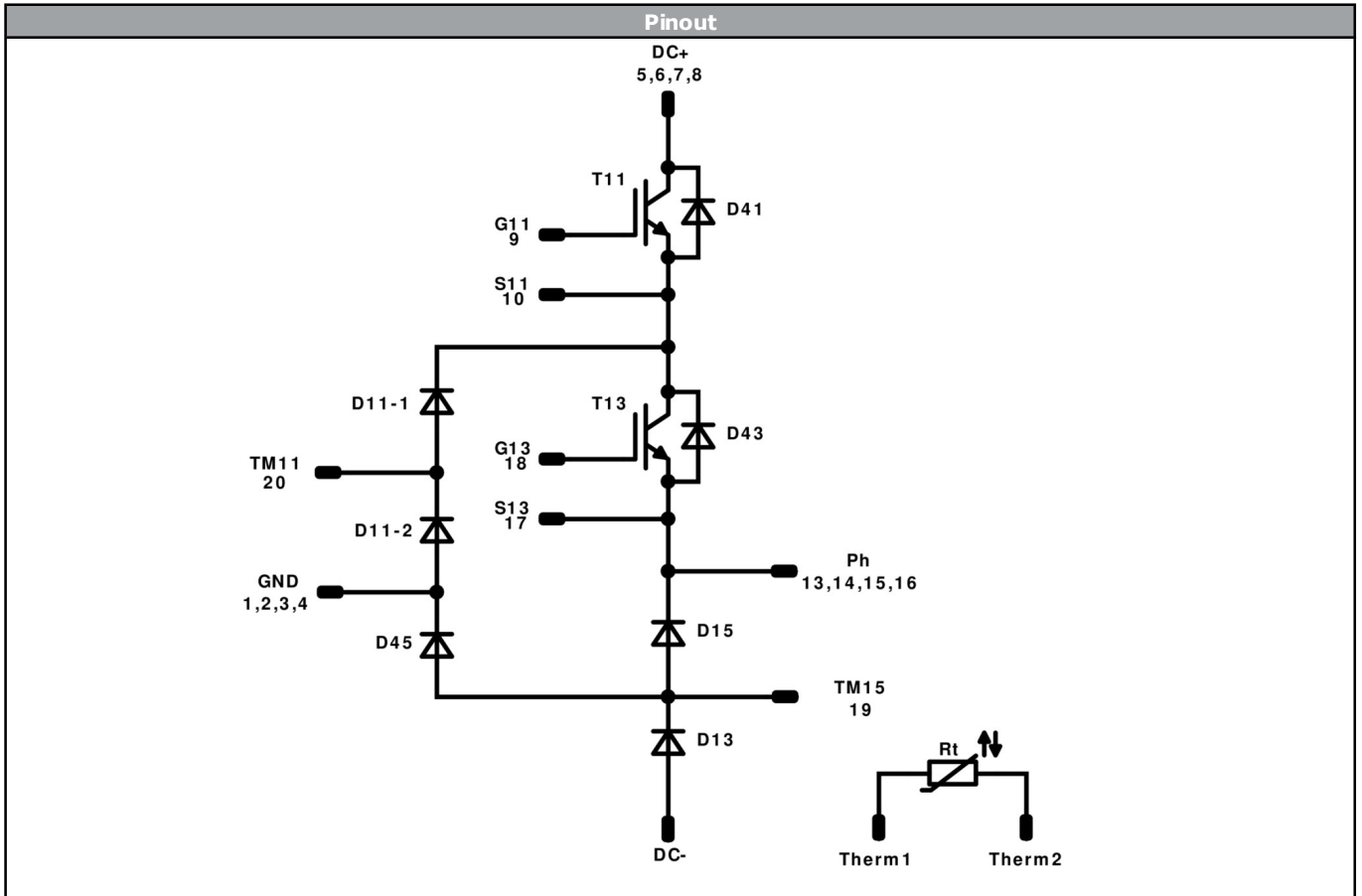

<b>Identification</b>					
<b>ID</b>	<b>Component</b>	<b>Voltage</b>	<b>Current</b>	<b>Function</b>	<b>Comment</b>
T11	IGBT	1200 V	200 A	Buck Switch	
D11-1, D11-2	FWD	1300 V	200 A	Buck Diode	Serial devices. Values apply to complete device.
D41	FWD	1200 V	75 A	Buck Sw. Protection Diode	
T13	IGBT	1200 V	200 A	Boost Switch	
D13	FWD	1200 V	75 A	Boost Diode	
D15	FWD	1600 V	75 A	Boost Sw.Inv.Diode	
D43	FWD	1600 V	75 A	Boost Sw. Protection Diode	
D45	FWD	1200 V	35 A	Boost D. Protection Diode	
Rt	NTC			Thermistor	



**10-F124NID200SH03-LG19F98**  
**10-F124NIE200SH03-LG29F98**  
 datasheet

Vincotech

Ordering Code & Marking									
<b>Version</b>			<b>Ordering Code</b>						
without thermal paste 17 mm housing with solder pins			10-F124NIE200SH03-LG29F98						
with thermal paste 17 mm housing with solder pins			10-F124NIE200SH03-LG29F98-/3/						
NN-NNNNNNNNNNNN TTTTIV WWYY UL VIN LLLL SSSS			<b>Text</b>	<b>Name</b>	<b>Date code</b>	<b>UL &amp; VIN</b>	<b>Lot</b>	<b>Serial</b>	
			Datamatrix						
				Type&Ver	Lot number	Serial	Date code		

**Low Side Module 10-F124NIE200SH03-LG29F98**

Pin table				Outline	
Pin	X	Y	Function		
1	53	9	GND		
2	53	6	GND		
3	53	3	GND		
4	53	0	GND		
5	41,15	0	DC-		
6	38,15	0	DC-		
7	35,15	0	DC-		
8	32,15	0	DC-		
9	38,75	3	Therm1		
10	35,75	3	Therm2		
11	12,9	2,55	S12		
12	9,9	3,55	G12		
13	0	20	Ph		
14	0	23	Ph		
15	0	26	Ph		
16	0	29	Ph		
17	14,15	18,55	G14		
18	17,15	17,55	S14		
19	37,15	20,7	TM12		
20	53	29	DC+		
21	53	26	DC+		
22	53	23	DC+		
23	53	20	DC+		
24	43,6	14,55	TM14		

Tolerance of pinpositions: ±0.5mm at the end of pins  
 Dimension of coordinate axis is only offset without tolerance



Vincotech

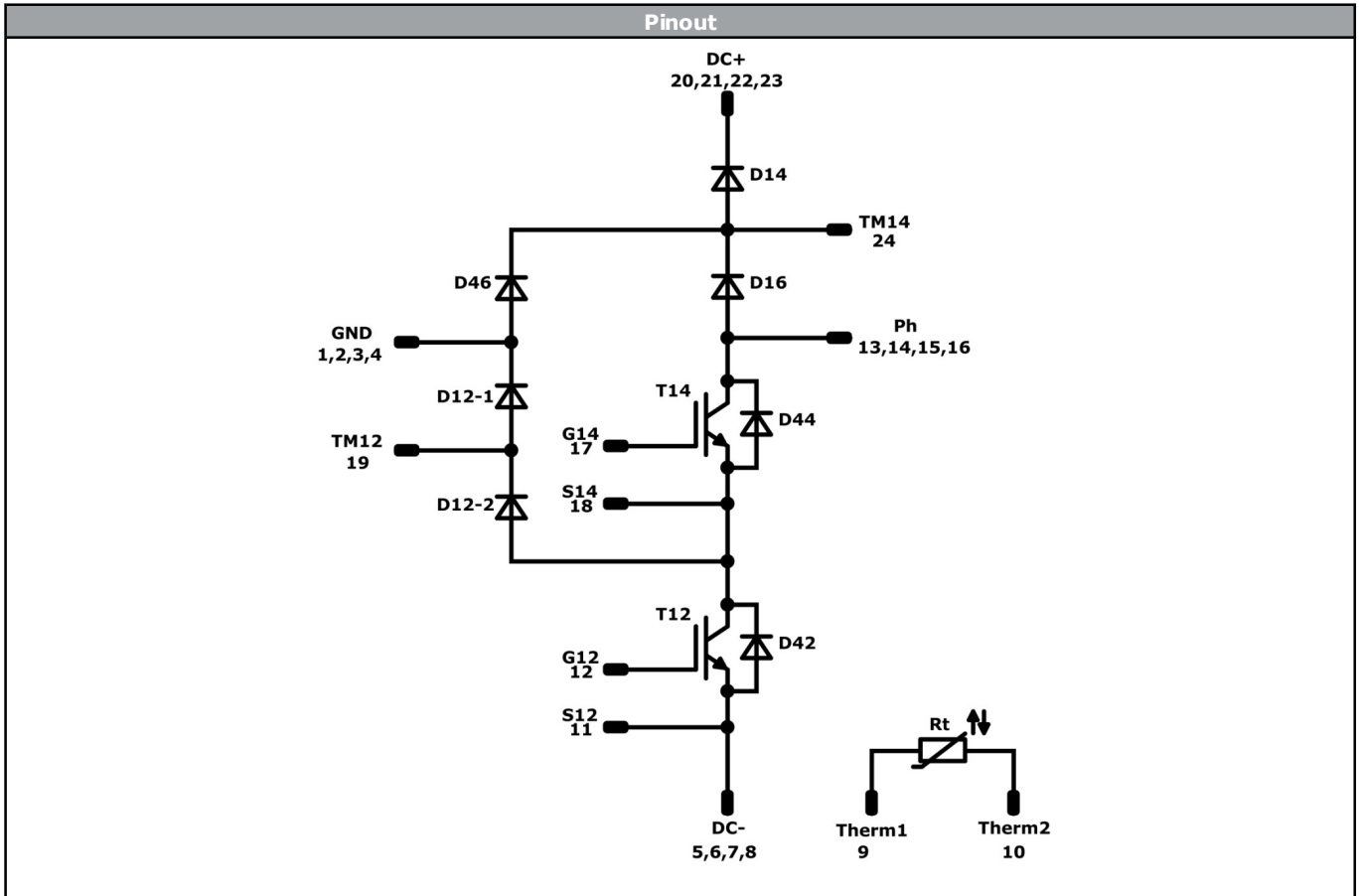

<b>Identification</b>					
<b>ID</b>	<b>Component</b>	<b>Voltage</b>	<b>Current</b>	<b>Function</b>	<b>Comment</b>
T12	IGBT	1200 V	200 A	Buck Switch	
D12-1,D12-2	FWD	1300 V	200 A	Buck Diode	Serial devices. Values apply to complete device.
D42	FWD	1200 V	75 A	Buck Sw. Protection Diode	
T14	IGBT	1200 V	200 A	Boost Switch	
D14	FWD	1200 V	75 A	Boost Diode	
D16	FWD	1600 V	75 A	Boost Sw.Inv.Diode	
D44	FWD	1600 V	75 A	Boost Sw. Protection Diode	
D46	FWD	1200 V	35 A	Boost D. Protection Diode	
Rt	NTC			Thermistor	



Vincotech

Packaging instruction			
Standard packaging quantity (SPQ) 100	>SPQ	Standard	<SPQ Sample

Handling instruction
Handling instructions for <i>flow 1</i> packages see vincotech.com website.

Package data
Package data for <i>flow 1</i> packages see vincotech.com website.

UL recognition and file number
This device is certified according to UL 1557 standard, UL file number E192116. For more information see vincotech.com website. 

Document No.:	Date:	Modification:	Pages
10-F124Nix200SH03-LGx9F98-D2-14	08 Jul. 2019	Marketing application voltage modified	1

**DISCLAIMER**

The information, specifications, procedures, methods and recommendations herein (together "information") are presented by Vincotech to reader in good faith, are believed to be accurate and reliable, but may well be incomplete and/or not applicable to all conditions or situations that may exist or occur. Vincotech reserves the right to make any changes without further notice to any products to improve reliability, function or design. No representation, guarantee or warranty is made to reader as to the accuracy, reliability or completeness of said information or that the application or use of any of the same will avoid hazards, accidents, losses, damages or injury of any kind to persons or property or that the same will not infringe third parties rights or give desired results. It is reader's sole responsibility to test and determine the suitability of the information and the product for reader's intended use.

**LIFE SUPPORT POLICY**

Vincotech products are not authorised for use as critical components in life support devices or systems without the express written approval of Vincotech.

As used herein:

1. Life support devices or systems are devices or systems which, (a) are intended for surgical implant into the body, or (b) support or sustain life, or (c) whose failure to perform when properly used in accordance with instructions for use provided in labelling can be reasonably expected to result in significant injury to the user.
2. A critical component is any component of a life support device or system whose failure to perform can be reasonably expected to cause the failure of the life support device or system, or to affect its safety or effectiveness.