

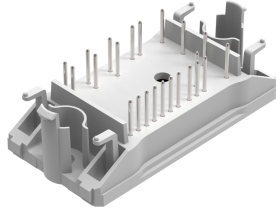

flowPIM 0		1200 V / 10 A	
Features		flow 0 17 mm housing	
<ul style="list-style-type: none">• IGBT M7 with low VCEsat and improved EMC behavior• Open emitter configuration• Compact and low inductive design• Built-in NTC			
Target applications		Schematic	
<ul style="list-style-type: none">• Industrial Drives			
Types			
<ul style="list-style-type: none">• 10-F012PMA010M7-P849A29			

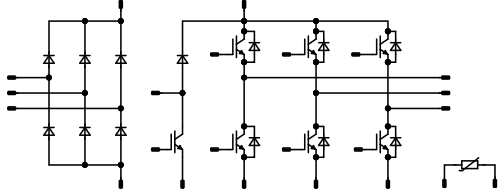

Vincotech

Maximum Ratings

$T_j = 25\text{ °C}$, unless otherwise specified

Parameter	Symbol	Conditions	Value	Unit
Inverter Switch				
Collector-emitter voltage	V_{CES}		1200	V
Collector current (DC current)	I_C	$T_j = T_{jmax}$ $T_s = 80\text{ °C}$	18	A
Repetitive peak collector current	I_{CRM}	t_p limited by T_{jmax}	20	A
Total power dissipation	P_{tot}	$T_j = T_{jmax}$ $T_s = 80\text{ °C}$	55	W
Gate-emitter voltage	V_{GES}		± 20	V
Short circuit ratings	t_{SC}	$V_{GE} = 0\text{ V}$, $V_{CC} = 800\text{ V}$ $T_j = 150\text{ °C}$	9,5	μs
Maximum junction temperature	T_{jmax}		175	$^{\circ}\text{C}$

Inverter Diode				
Peak repetitive reverse voltage	V_{RRM}		1200	V
Forward current (DC current)	I_F	$T_j = T_{jmax}$ $T_s = 80\text{ °C}$	19	A
Total power dissipation	P_{tot}	$T_j = T_{jmax}$ $T_s = 80\text{ °C}$	44	W
Maximum junction temperature	T_{jmax}		175	$^{\circ}\text{C}$

Brake Switch				
Collector-emitter voltage	V_{CES}		1200	V
Collector current (DC current)	I_C	$T_j = T_{jmax}$ $T_s = 80\text{ °C}$	11	A
Repetitive peak collector current	I_{CRM}	t_p limited by T_{jmax}	10	A
Total power dissipation	P_{tot}	$T_j = T_{jmax}$ $T_s = 80\text{ °C}$	41	W
Gate-emitter voltage	V_{GES}		± 20	V
Short circuit ratings	t_{SC}	$V_{GE} = 15\text{ V}$, $V_{CC} = 800\text{ V}$ $T_j = 150\text{ °C}$	9,5	μs
Maximum junction temperature	T_{jmax}		175	$^{\circ}\text{C}$



Vincotech

Maximum Ratings

$T_j = 25\text{ °C}$, unless otherwise specified

Parameter	Symbol	Conditions	Value	Unit
Brake Diode				
Peak repetitive reverse voltage	V_{RRM}		1200	V
Forward current (DC current)	I_F	$T_j = T_{jmax}$ $T_s = 80\text{ °C}$	11	A
Repetitive peak forward current	I_{FRM}	t_p limited by T_{jmax}	10	A
Total power dissipation	P_{tot}	$T_j = T_{jmax}$ $T_s = 80\text{ °C}$	27	W
Maximum junction temperature	T_{jmax}		175	°C

Rectifier Diode

Peak repetitive reverse voltage	V_{RRM}		1600	V
Forward current (DC current)	I_F	$T_j = T_{jmax}$ $T_s = 80\text{ °C}$	33	A
Surge (non-repetitive) forward current	I_{FSM}	Single Half Sine Wave, $t_p = 10\text{ ms}$ $T_j = 150\text{ °C}$	200	A
Surge current capability	I^2t		200	A ² s
Total power dissipation	P_{tot}	$T_j = T_{jmax}$ $T_s = 80\text{ °C}$	44	W
Maximum junction temperature	T_{jmax}		150	°C

Module Properties

Thermal Properties

Storage temperature	T_{stg}		-40...+125	°C
Operation temperature under switching condition	T_{jop}		-40...+($T_{jmax} - 25$)	°C

Isolation Properties

Isolation voltage	V_{isol}	DC Test Voltage* $t_p = 2\text{ s}$	6000	V
Isolation voltage	V_{isol}	AC Voltage $t_p = 1\text{ min}$	2500	V
Creepage distance			>12,7	mm
Clearance			>12,7	mm
Comparative Tracking Index	CTI		≥ 200	

*100 % tested in production



Vincotech

Characteristic Values

Parameter	Symbol	Conditions					Values			Unit
		V_{GS} [V]	V_{GE} [V]	V_{DS} [V]	V_F [V]	I_C [A] I_D [A] I_F [A]	T_j [°C]	Min	Typ	

Inverter Switch

Static

Gate-emitter threshold voltage	$V_{GE(th)}$			10	0,001	25	5,4	6	6,6	V
Collector-emitter saturation voltage	$V_{CE(sat)}$		15		10	25 125 150		1,66 1,9 1,96	2,15 ⁽¹⁾	V
Collector-emitter cut-off current	I_{CES}		0	1200		25			35	μA
Gate-emitter leakage current	I_{GES}		0	0		25			500	nA
Internal gate resistance	r_g							None		Ω
Input capacitance	C_{ies}							2000		pF
Output capacitance	C_{oes}		0	10		25		86		pF
Reverse transfer capacitance	C_{res}							23		pF
Gate charge	Q_g	$V_{CC} = 600$ V	15		10	25		80		nC

Thermal

Thermal resistance junction to sink ⁽²⁾	$R_{th(j-s)}$	$\lambda_{paste} = 3,4$ W/mK (PSX)						1,72		K/W
--	---------------	---------------------------------------	--	--	--	--	--	------	--	-----

Dynamic

Turn-on delay time	$t_{d(on)}$					25 125 150		127,8 125,6 123,4		ns
Rise time	t_r					25 125 150		29 32,2 33,8		ns
Turn-off delay time	$t_{d(off)}$					25 125 150		145,2 179,2 182		ns
Fall time	t_f					25 125 150		98,1 107,57 116,71		ns
Turn-on energy (per pulse)	E_{on}	$Q_{tfWD} = 1,09$ μC $Q_{tfWD} = 1,66$ μC $Q_{tfWD} = 1,81$ μC				25 125 150		0,883 1,12 1,19		mWs
Turn-off energy (per pulse)	E_{off}					25 125 150		0,656 0,86 0,908		mWs



Vincotech

Characteristic Values

Parameter	Symbol	Conditions					Values			Unit
		V_{GE} [V] V_{GS} [V]	V_{CE} [V] V_{DS} [V] V_F [V]	I_C [A] I_D [A] I_F [A]	T_j [°C]	Min	Typ	Max		
Inverter Diode										
Static										
Forward voltage	V_F				10	25 125 150		1,61 1,69 1,7	2,1 ⁽¹⁾	V
Reverse leakage current	I_R	$V_r = 1200$ V				25			25	μA
Thermal										
Thermal resistance junction to sink ⁽²⁾	$R_{th(j-s)}$	$\lambda_{paste} = 3,4$ W/mK (PSX)						2,16		K/W
Dynamic										
Peak recovery current	I_{RRM}					25 125 150		8,67 9,25 9,34		A
Reverse recovery time	t_{rr}					25 125 150		254,4 372,9 409		ns
Recovered charge	Q_r	$di/dt=278$ A/μs $di/dt=270$ A/μs $di/dt=272$ A/μs	±15	600	10	25 125 150		1,09 1,66 1,81		μC
Reverse recovered energy	E_{rec}					25 125 150		0,374 0,62 0,68		mWs
Peak rate of fall of recovery current	$(di_r/dt)_{max}$					25 125 150		84,75 53,58 49,28		A/μs



Vincotech

Characteristic Values

Parameter	Symbol	Conditions					Values			Unit
		V_{GS} [V]	V_{GE} [V]	V_{DS} [V]	I_D [A]	T_j [°C]	Min	Typ	Max	

Brake Switch

Static

Gate-emitter threshold voltage	$V_{GE(th)}$			10	0,0005	25	5,4	6	6,6	V
Collector-emitter saturation voltage	$V_{CE(sat)}$		15		5	25 125 150		1,63 1,83 1,9	1,95 ⁽¹⁾	V
Collector-emitter cut-off current	I_{CES}		0	1200		25			20	μA
Gate-emitter leakage current	I_{GES}		20	0		25			500	nA
Internal gate resistance	r_g							None		Ω
Input capacitance	C_{ies}							1100		pF
Output capacitance	C_{oes}		0	10		25		57		pF
Reverse transfer capacitance	C_{res}							11		pF
Gate charge	Q_g	$V_{CC} = 600$ V	15		5	25		40		nC

Thermal

Thermal resistance junction to sink ⁽²⁾	$R_{th(j-s)}$	$\lambda_{paste} = 3,4$ W/mK (PSX)						2,3		K/W
--	---------------	---------------------------------------	--	--	--	--	--	-----	--	-----

Dynamic

Turn-on delay time	$t_{d(on)}$	$R_{gon} = 64$ Ω $R_{goff} = 64$ Ω	0/15	600	5	25		78,6		ns				
						125		73						
						150		72,2						
Rise time	t_r									25		44,6		ns
										125		48,4		
										150		49		
Turn-off delay time	$t_{d(off)}$									25		234,4		ns
						125		261,6						
						150		269,8						
Fall time	t_f					25		101,2		ns				
						125		114,14						
						150		117,21						
Turn-on energy (per pulse)	E_{on}	$Q_{tFWD} = 0,558$ μC $Q_{tFWD} = 0,833$ μC $Q_{tFWD} = 0,935$ μC				25		0,48		mWs				
						125		0,609						
						150		0,634						
Turn-off energy (per pulse)	E_{off}					25		0,345		mWs				
						125		0,454						
						150		0,474						



Vincotech

10-F012PMA010M7-P849A29
datasheet

Characteristic Values

Parameter	Symbol	Conditions						Values			Unit
		V_{GE} [V]	V_{GS} [V]	V_{CE} [V]	V_{DS} [V]	I_C [A]	T_j [°C]	Min	Typ	Max	
Brake Diode											
Static											
Forward voltage	V_F				5	25 125 150		1,57 1,66 1,65	2,1 ⁽¹⁾	V	
Reverse leakage current	I_R	$V_T = 1200$ V				25			20	μA	
Thermal											
Thermal resistance junction to sink ⁽²⁾	$R_{th(j-s)}$	$\lambda_{paste} = 3,4$ W/mK (PSX)						3,5		K/W	
Dynamic											
Peak recovery current	I_{RRM}					25 125 150		3,83 4,17 4,24		A	
Reverse recovery time	t_{rr}					25 125 150		258,78 386,26 431,26		ns	
Recovered charge	Q_r	$di/dt=85$ A/μs $di/dt=102$ A/μs $di/dt=87$ A/μs	0/15	600	5	25 125 150		0,558 0,833 0,935		μC	
Reverse recovered energy	E_{rec}					25 125 150		0,2 0,314 0,362		mWs	
Peak rate of fall of recovery current	$(di_r/dt)_{max}$					25 125 150		37,47 24,29 19,53		A/μs	



Characteristic Values

Parameter	Symbol	Conditions					Values			Unit
		V_{GE} [V] V_{GS} [V]	V_{CE} [V] V_{DS} [V] V_F [V]	I_C [A] I_D [A] I_F [A]	T_j [°C]	Min	Typ	Max		

Rectifier Diode

Static

Forward voltage	V_F				8	25 125		0,996 0,907	1,21 ⁽¹⁾ 1,1 ⁽¹⁾	V
Reverse leakage current	I_R	$V_i = 1600$ V				25			50	μA

Thermal

Thermal resistance junction to sink ⁽²⁾	$R_{th(j-s)}$	$\lambda_{paste} = 3,4$ W/mK (PSX)						1,59		K/W
--	---------------	---------------------------------------	--	--	--	--	--	------	--	-----

Thermistor

Static

Rated resistance	R					25		22		kΩ
Deviation of R_{100}	$\Delta_{R/R}$	$R_{100} = 1484$ Ω				100	-5		5	%
Power dissipation	P							5		mW
Power dissipation constant	d					25		1,5		mW/K
B-value	$B_{(25/50)}$	Tol. ±1 %						3962		K
B-value	$B_{(25/100)}$	Tol. ±1 %						4000		K
Vincotech Thermistor Reference									I	

⁽¹⁾ Value at chip level

⁽²⁾ Only valid with pre-applied Vincotech thermal interface material.



Inverter Switch Characteristics

figure 1. IGBT

Typical output characteristics

$$I_C = f(V_{CE})$$

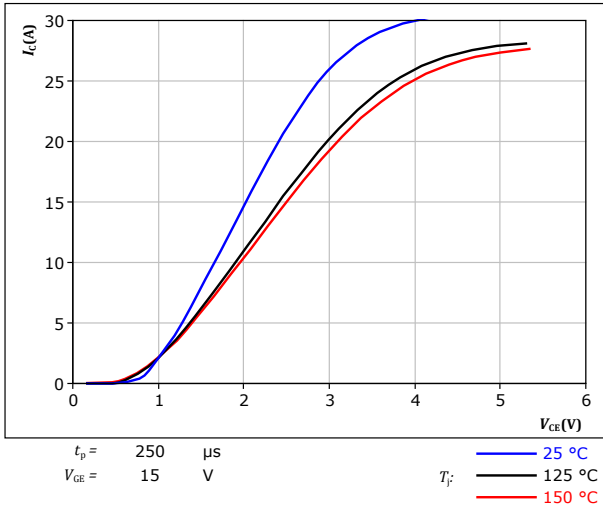

figure 2. IGBT

Typical output characteristics

$$I_C = f(V_{CE})$$

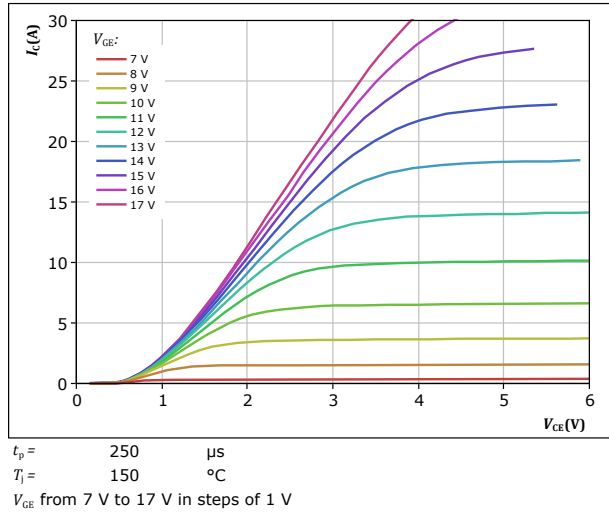

figure 3. IGBT

Typical transfer characteristics

$$I_C = f(V_{GE})$$

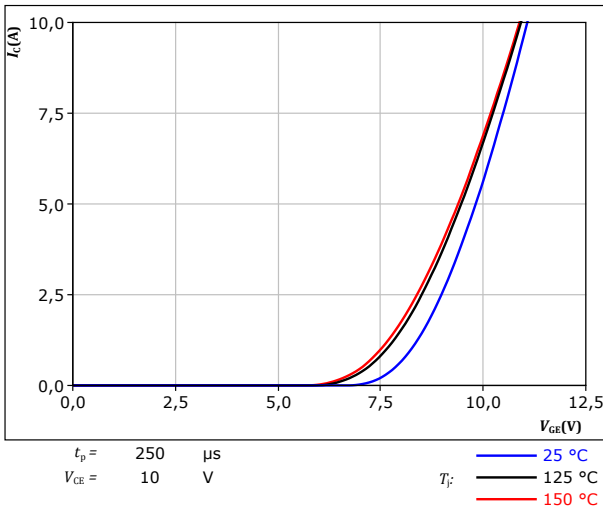
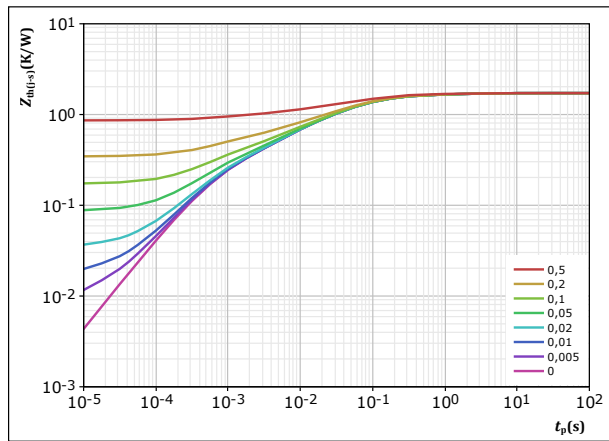

figure 4. IGBT

Transient thermal impedance as a function of pulse width

$$Z_{th(j-s)} = f(t_p)$$



$D = t_p / T$
 $R_{th(j-s)} = 1,722 \text{ K/W}$

IGBT thermal model values

R (K/W)	τ (s)
8,08E-02	2,32E+00
2,21E-01	2,45E-01
6,51E-01	6,03E-02
3,93E-01	1,33E-02
1,95E-01	3,15E-03
1,82E-01	5,45E-04



Inverter Switch Characteristics

figure 5. IGBT

Safe operating area

$$I_C = f(V_{CE})$$

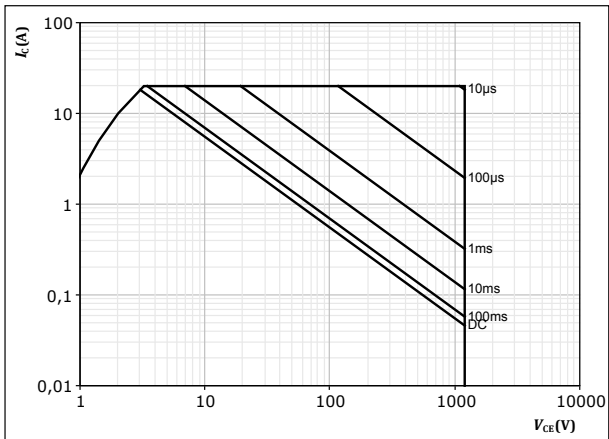

$D =$ single pulse
 $T_s = 80$ °C
 $V_{GE} = 15$ V
 $T_j = T_{jmax}$



Inverter Diode Characteristics

figure 6. FWD

Typical forward characteristics

$$I_F = f(V_F)$$

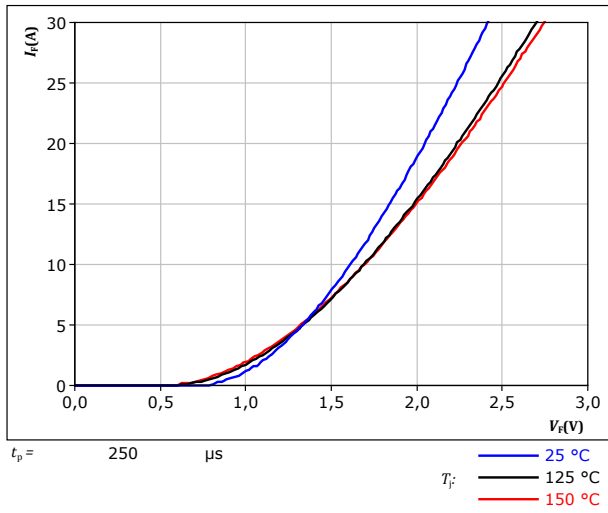
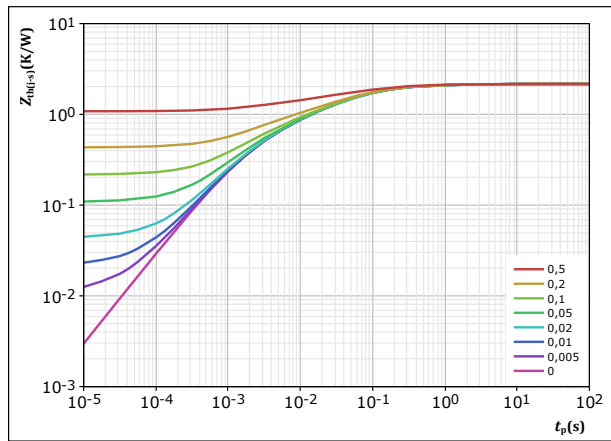

figure 7. FWD

Transient thermal impedance as a function of pulse width

$$Z_{th(j-s)} = f(t_p)$$



$D =$	t_p / T	
$R_{th(j-s)} =$	2,162	K/W
FWD thermal model values		
R (K/W)	τ (s)	
9,29E-02	2,25E+00	
3,88E-01	2,05E-01	
7,75E-01	5,06E-02	
5,89E-01	8,88E-03	
3,17E-01	1,48E-03	



Brake Switch Characteristics

figure 8. IGBT

Typical output characteristics
 $I_C = f(V_{CE})$

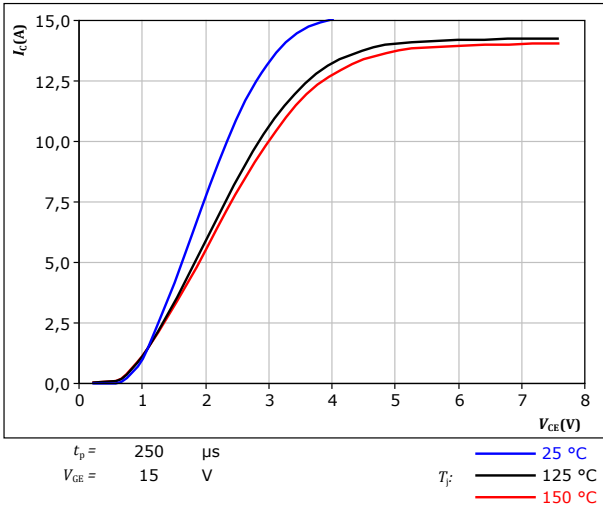

figure 9. IGBT

Typical output characteristics
 $I_C = f(V_{CE})$

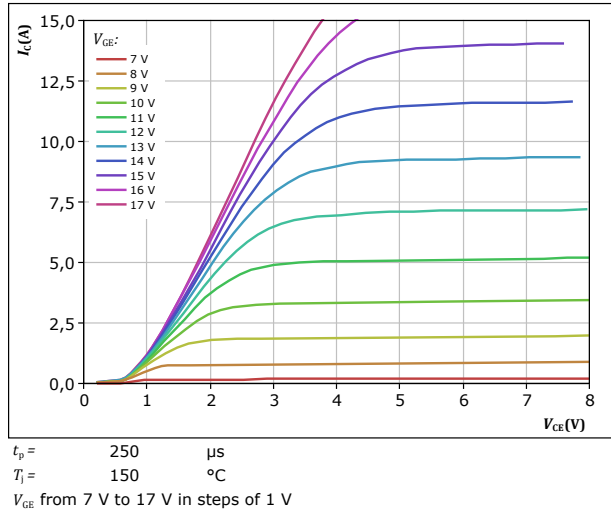

figure 10. IGBT

Typical transfer characteristics
 $I_C = f(V_{GE})$

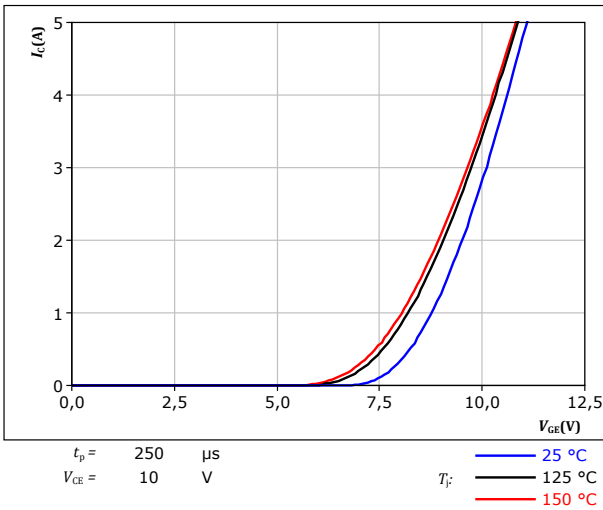
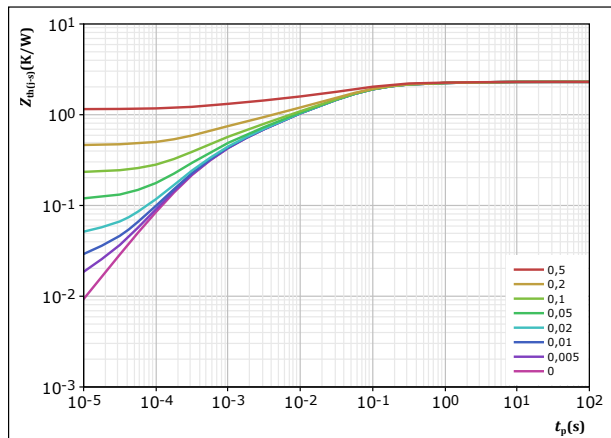

figure 11. IGBT

Transient thermal impedance as a function of pulse width
 $Z_{th(j-s)} = f(t_p)$



IGBT thermal model values

R (K/W)	τ (s)
6,25E-02	3,48E+00
1,37E-01	5,00E-01
7,38E-01	8,11E-02
5,28E-01	2,49E-02
3,84E-01	5,54E-03
2,39E-01	1,24E-03
2,13E-01	3,29E-04



Brake Switch Characteristics

figure 12. IGBT

Safe operating area

$$I_C = f(V_{CE})$$

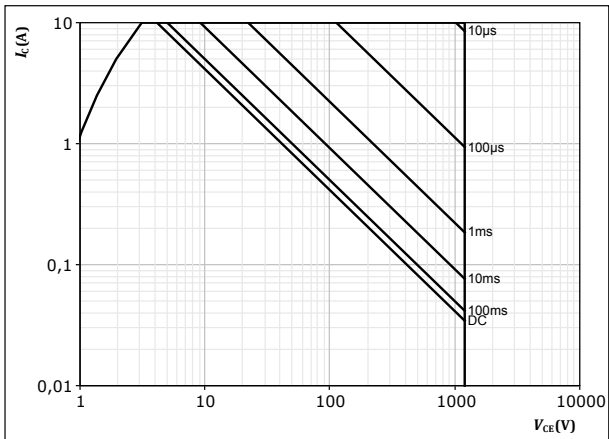

$D =$ single pulse
 $T_s = 80 \text{ } ^\circ\text{C}$
 $V_{GE} = 15 \text{ V}$
 $T_j = T_{jmax}$



Brake Diode Characteristics

figure 13. FWD

Typical forward characteristics

$$I_F = f(V_F)$$

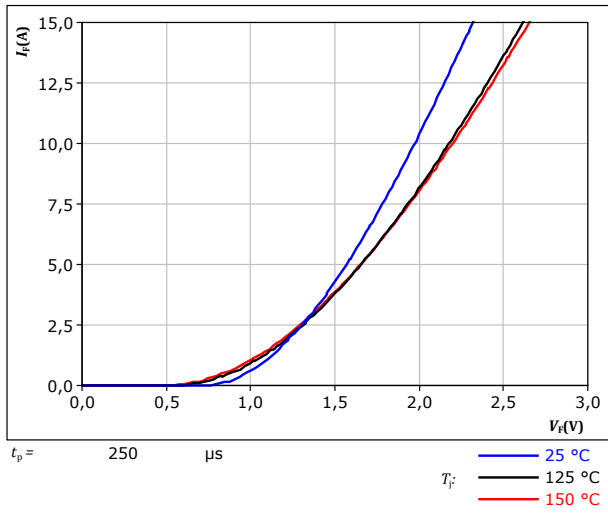
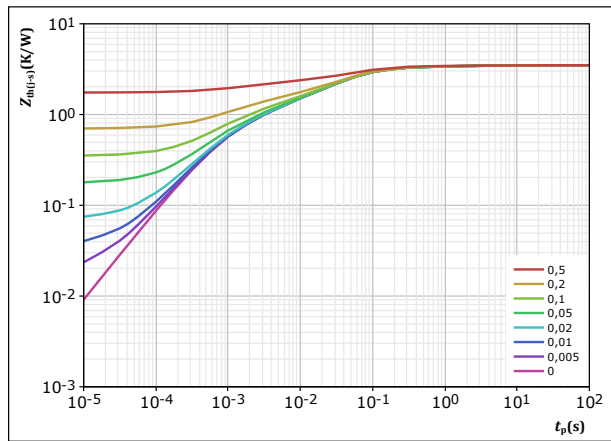

figure 14. FWD

Transient thermal impedance as a function of pulse width

$$Z_{th(j-s)} = f(t_p)$$



$D = \frac{t_p}{T}$
 $R_{th(j-s)} = 3,495 \text{ K/W}$
 FWD thermal model values

R (K/W)	τ (s)
8,03E-02	7,23E+00
2,34E-01	4,70E-01
1,33E+00	6,36E-02
7,92E-01	2,24E-02
5,71E-01	3,34E-03
4,85E-01	7,05E-04



Rectifier Diode Characteristics

figure 15. Rectifier

Typical forward characteristics

$$I_F = f(V_F)$$

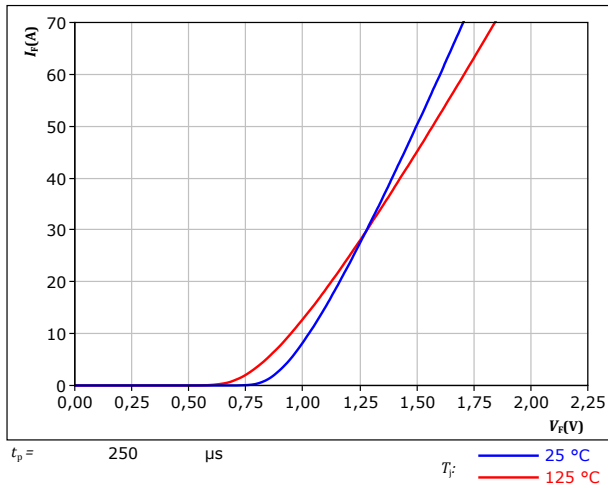
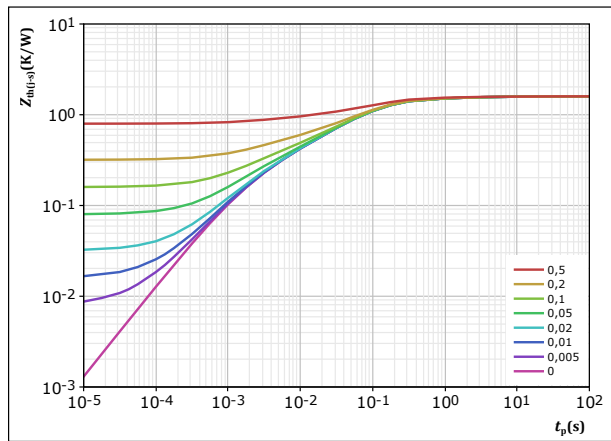

figure 16. Rectifier

Transient thermal impedance as a function of pulse width

$$Z_{th(j-s)} = f(t_p)$$



$$D = \frac{t_p}{T}$$

$$R_{th(j-s)} = 1,594 \text{ K/W}$$

Rectifier thermal model values

R (K/W)	τ (s)
3,44E-02	9,66E+00
1,12E-01	1,22E+00
5,81E-01	1,45E-01
4,89E-01	5,05E-02
2,38E-01	9,26E-03
1,22E-01	1,79E-03
1,81E-02	7,88E-04



Thermistor Characteristics

figure 17. Thermistor

Typical NTC characteristic as function of temperature

$$R_T = f(T)$$

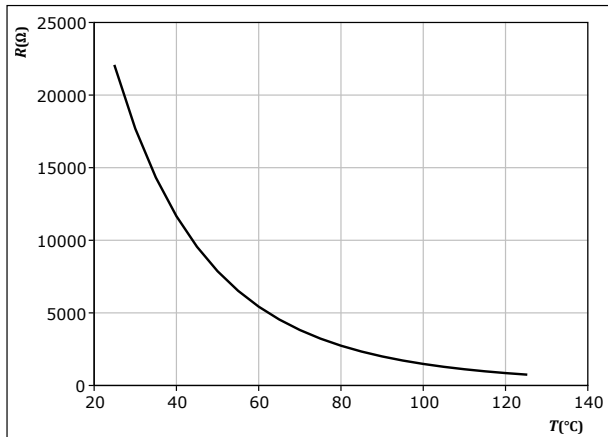



Inverter Switching Characteristics

figure 18. IGBT

Typical switching energy losses as a function of collector current
 $E = f(I_c)$

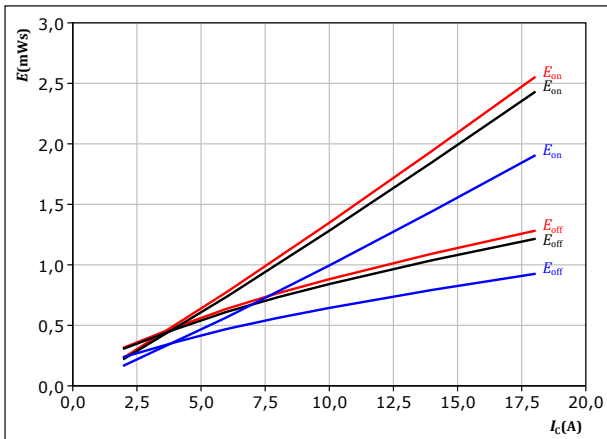

With an inductive load at
 $V_{CE} = 600$ V
 $V_{GE} = \pm 15$ V
 $R_{gon} = 32$ Ω
 $R_{goff} = 32$ Ω
 T_j : 25 °C (blue), 125 °C (black), 150 °C (red)

figure 19. IGBT

Typical switching energy losses as a function of gate resistor
 $E = f(R_g)$

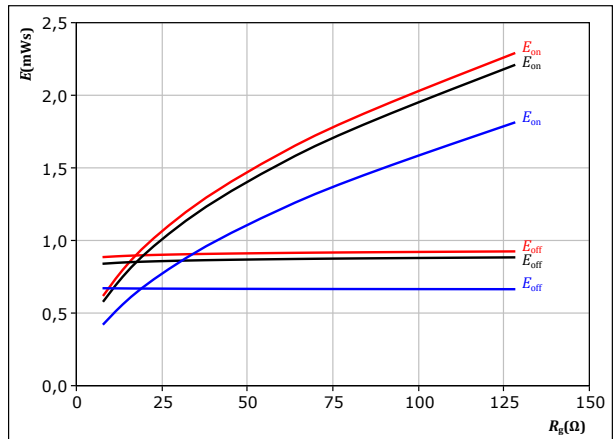

With an inductive load at
 $V_{CE} = 600$ V
 $V_{GE} = \pm 15$ V
 $I_c = 10$ A
 T_j : 25 °C (blue), 125 °C (black), 150 °C (red)

figure 20. FWD

Typical reverse recovered energy loss as a function of collector current
 $E_{rec} = f(I_c)$

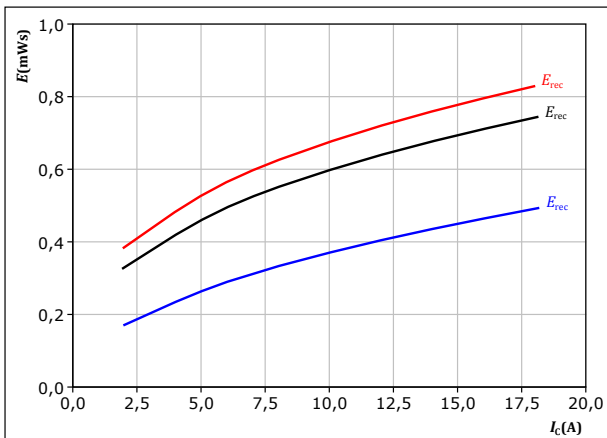

With an inductive load at
 $V_{CE} = 600$ V
 $V_{GE} = \pm 15$ V
 $R_{gon} = 32$ Ω
 T_j : 25 °C (blue), 125 °C (black), 150 °C (red)

figure 21. FWD

Typical reverse recovered energy loss as a function of gate resistor
 $E_{rec} = f(R_g)$

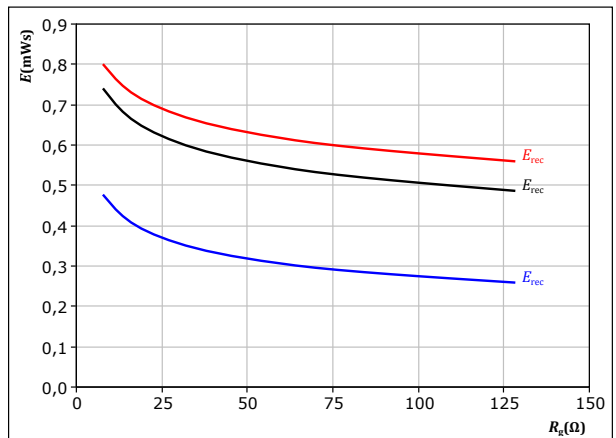

With an inductive load at
 $V_{CE} = 600$ V
 $V_{GE} = \pm 15$ V
 $I_c = 10$ A
 T_j : 25 °C (blue), 125 °C (black), 150 °C (red)



Inverter Switching Characteristics

figure 22. IGBT

Typical switching times as a function of collector current
 $t = f(I_c)$

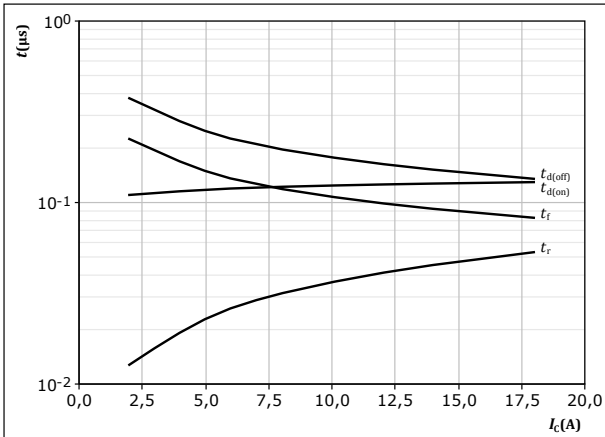

With an inductive load at
 $T_j = 150 \text{ }^\circ\text{C}$
 $V_{CE} = 600 \text{ V}$
 $V_{GE} = \pm 15 \text{ V}$
 $R_{g(on)} = 32 \text{ } \Omega$
 $R_{g(off)} = 32 \text{ } \Omega$

figure 23. IGBT

Typical switching times as a function of gate resistor
 $t = f(R_g)$

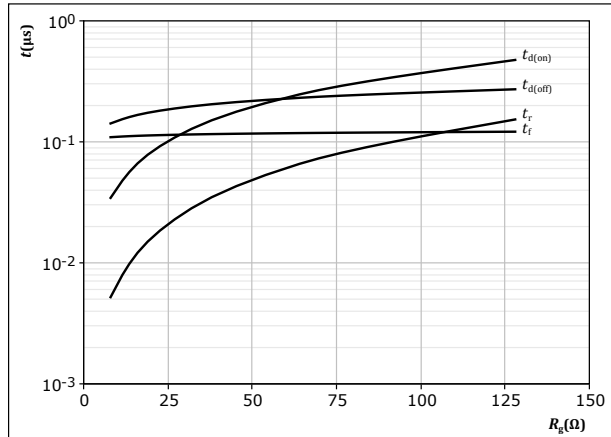

With an inductive load at
 $T_j = 150 \text{ }^\circ\text{C}$
 $V_{CE} = 600 \text{ V}$
 $V_{GE} = \pm 15 \text{ V}$
 $I_c = 10 \text{ A}$

figure 24. FWD

Typical reverse recovery time as a function of collector current
 $t_{rr} = f(I_c)$

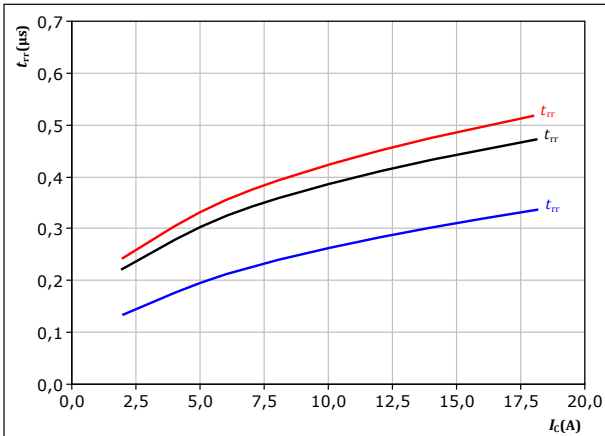

With an inductive load at
 $V_{CE} = 600 \text{ V}$
 $V_{GE} = \pm 15 \text{ V}$
 $R_{g(on)} = 32 \text{ } \Omega$
 $T_j:$ — 25 °C
 — 125 °C
 — 150 °C

figure 25. FWD

Typical reverse recovery time as a function of IGBT turn off gate resistor
 $t_{rr} = f(R_{g(off)})$

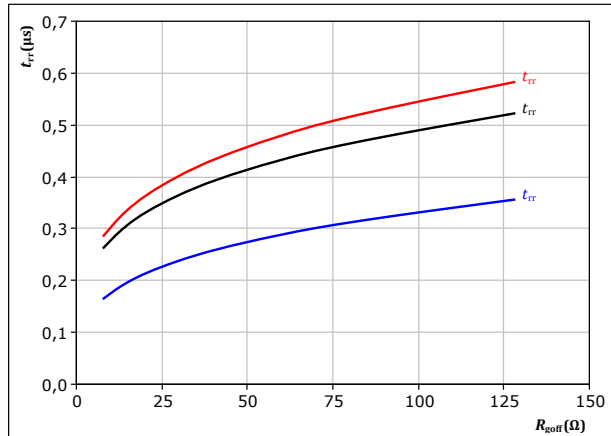

With an inductive load at
 $V_{CE} = 600 \text{ V}$
 $V_{GE} = \pm 15 \text{ V}$
 $I_c = 10 \text{ A}$
 $T_j:$ — 25 °C
 — 125 °C
 — 150 °C



Inverter Switching Characteristics

figure 26. FWD

Typical recovered charge as a function of collector current

$$Q_r = f(I_c)$$

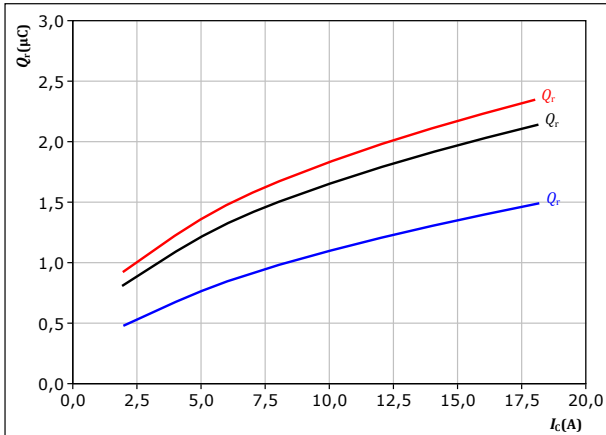

With an inductive load at

$V_{CE} = 600 \text{ V}$
 $V_{GE} = \pm 15 \text{ V}$
 $R_{goff} = 32 \ \Omega$

T_j : — 25 °C
— 125 °C
— 150 °C

figure 27. FWD

Typical recovered charge as a function of turn off gate resistor

$$Q_r = f(R_{goff})$$

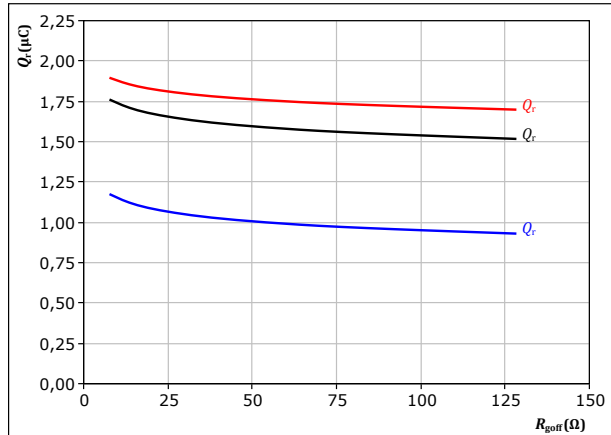

With an inductive load at

$V_{CE} = 600 \text{ V}$
 $V_{GE} = \pm 15 \text{ V}$
 $I_c = 10 \text{ A}$

T_j : — 25 °C
— 125 °C
— 150 °C

figure 28. FWD

Typical peak reverse recovery current as a function of collector current

$$I_{RM} = f(I_c)$$

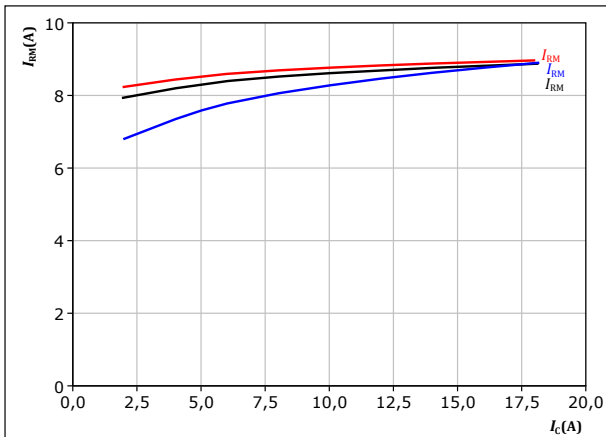

With an inductive load at

$V_{CE} = 600 \text{ V}$
 $V_{GE} = \pm 15 \text{ V}$
 $R_{goff} = 32 \ \Omega$

T_j : — 25 °C
— 125 °C
— 150 °C

figure 29. FWD

Typical peak reverse recovery current as a function of turn off gate resistor

$$I_{RM} = f(R_{goff})$$

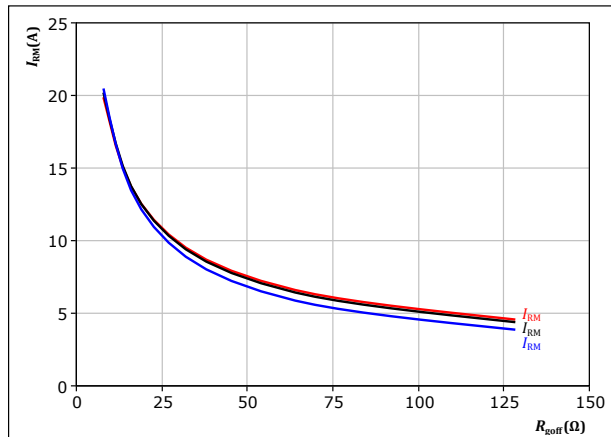

With an inductive load at

$V_{CE} = 600 \text{ V}$
 $V_{GE} = \pm 15 \text{ V}$
 $I_c = 10 \text{ A}$

T_j : — 25 °C
— 125 °C
— 150 °C



Inverter Switching Characteristics

figure 30. FWD

Typical rate of fall of forward and reverse recovery current as a function of collector current
 $di_f/dt, di_r/dt = f(I_c)$

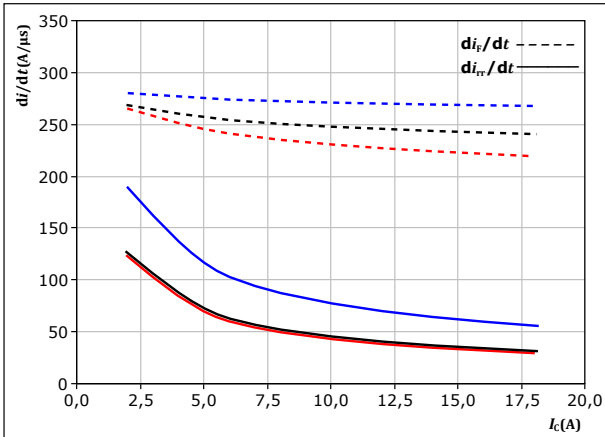

With an inductive load at

$V_{CE} = 600 \text{ V}$
 $V_{GE} = \pm 15 \text{ V}$
 $R_{goff} = 32 \text{ } \Omega$

T_j :
— 25 °C
— 125 °C
— 150 °C

figure 31. FWD

Typical rate of fall of forward and reverse recovery current as a function of turn off gate resistor
 $di_f/dt, di_r/dt = f(R_{goff})$

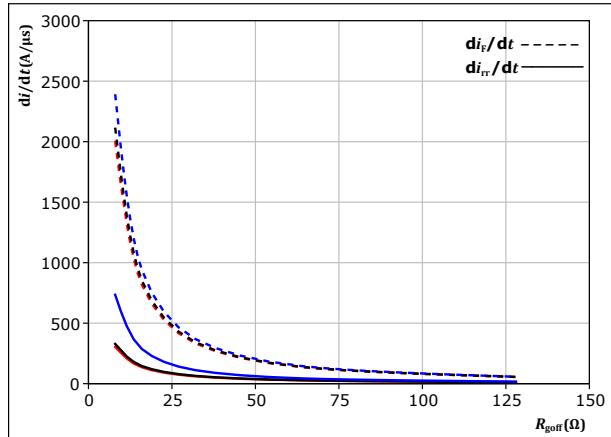

With an inductive load at

$V_{CE} = 600 \text{ V}$
 $V_{GE} = \pm 15 \text{ V}$
 $I_c = 10 \text{ A}$

T_j :
— 25 °C
— 125 °C
— 150 °C

figure 32. IGBT

Reverse bias safe operating area

$I_c = f(V_{CE})$

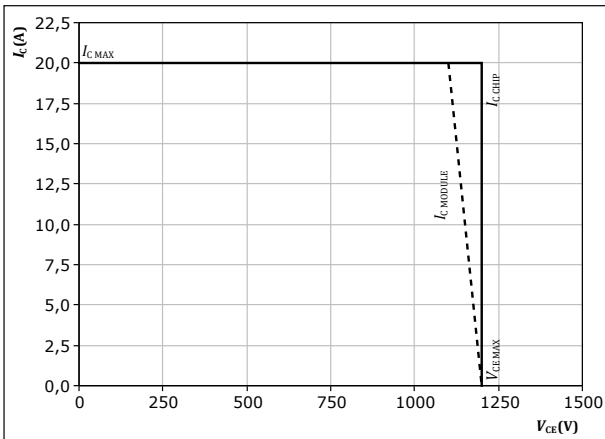

At $T_j = 150 \text{ } ^\circ\text{C}$
 $R_{goff} = 32 \text{ } \Omega$
 $R_{goff} = 32 \text{ } \Omega$



Brake Switching Characteristics

figure 33. IGBT

Typical switching energy losses as a function of collector current
 $E = f(I_c)$

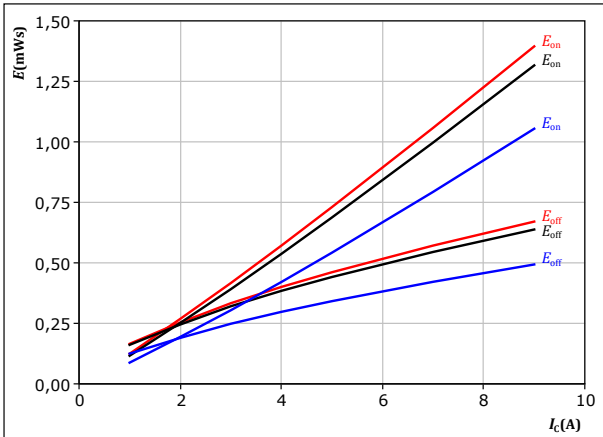

With an inductive load at

$V_{CE} =$	600	V	$T_j:$	—	25 °C
$V_{GE} =$	0/15	V		—	125 °C
$R_{g(on)} =$	64	Ω		—	150 °C
$R_{g(off)} =$	64	Ω			

figure 34. IGBT

Typical switching energy losses as a function of gate resistor
 $E = f(R_g)$

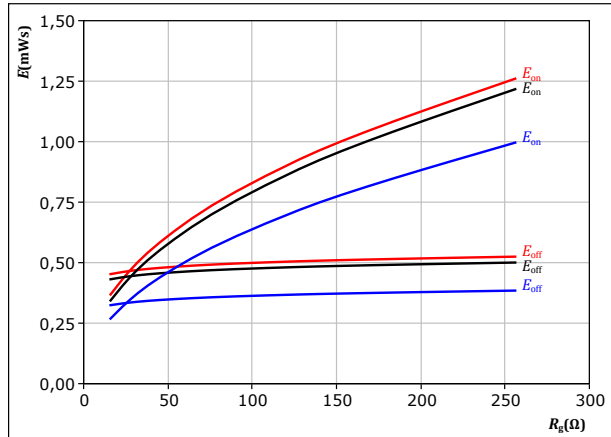

With an inductive load at

$V_{CE} =$	600	V	$T_j:$	—	25 °C
$V_{GE} =$	0/15	V		—	125 °C
$I_c =$	5	A		—	150 °C

figure 35. FWD

Typical reverse recovered energy loss as a function of collector current
 $E_{rec} = f(I_c)$

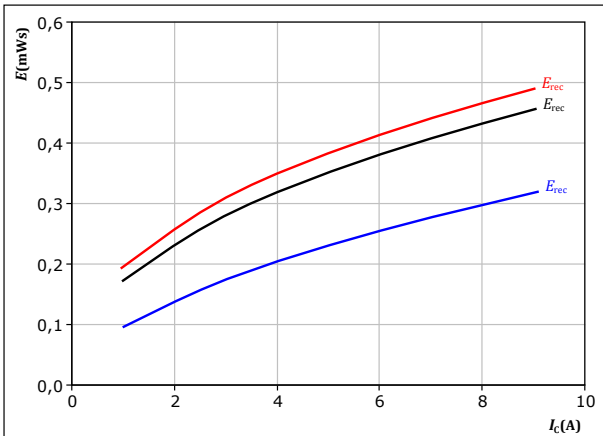

With an inductive load at

$V_{CE} =$	600	V	$T_j:$	—	25 °C
$V_{GE} =$	0/15	V		—	125 °C
$R_{g(on)} =$	64	Ω		—	150 °C

figure 36. FWD

Typical reverse recovered energy loss as a function of gate resistor
 $E_{rec} = f(R_g)$

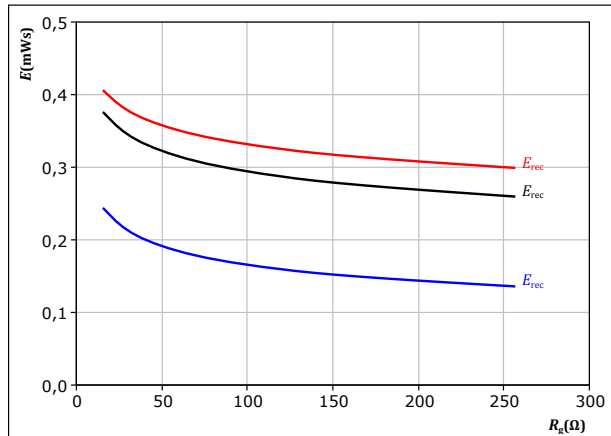

With an inductive load at

$V_{CE} =$	600	V	$T_j:$	—	25 °C
$V_{GE} =$	0/15	V		—	125 °C
$I_c =$	5	A		—	150 °C



Brake Switching Characteristics

figure 37. IGBT

Typical switching times as a function of collector current
 $t = f(I_c)$

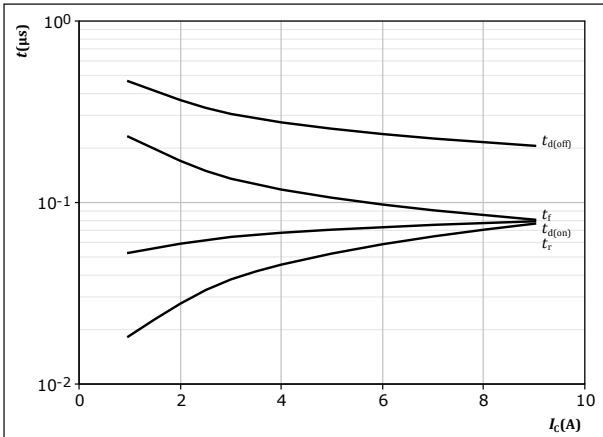

With an inductive load at
 $T_j = 150$ °C
 $V_{CE} = 600$ V
 $V_{GE} = 0/15$ V
 $R_{gon} = 64$ Ω
 $R_{goff} = 64$ Ω

figure 38. IGBT

Typical switching times as a function of gate resistor
 $t = f(R_g)$

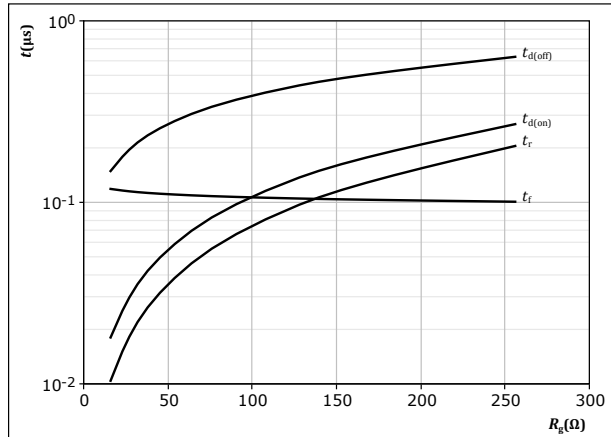

With an inductive load at
 $T_j = 150$ °C
 $V_{CE} = 600$ V
 $V_{GE} = 0/15$ V
 $I_c = 5$ A

figure 39. FWD

Typical reverse recovery time as a function of collector current
 $t_{rr} = f(I_c)$

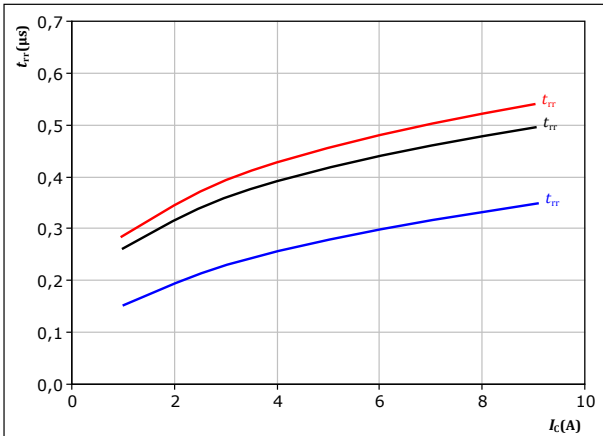

With an inductive load at
 $V_{CE} = 600$ V
 $V_{GE} = 0/15$ V
 $R_{gon} = 64$ Ω
 T_j : — 25 °C
— 125 °C
— 150 °C

figure 40. FWD

Typical reverse recovery time as a function of IGBT turn off gate resistor
 $t_{rr} = f(R_{goff})$

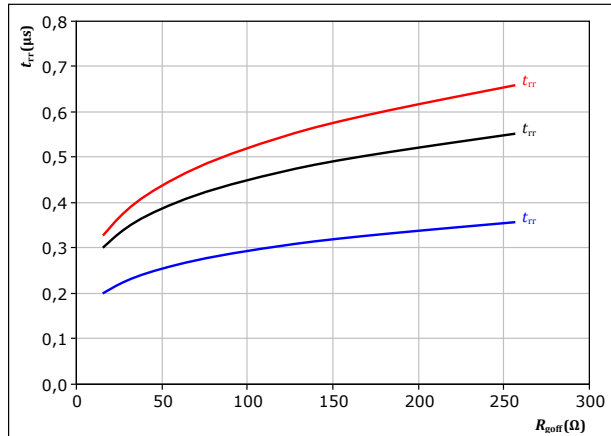

With an inductive load at
 $V_{CE} = 600$ V
 $V_{GE} = 0/15$ V
 $I_c = 5$ A
 T_j : — 25 °C
— 125 °C
— 150 °C



Brake Switching Characteristics

figure 41. FWD

Typical recovered charge as a function of collector current

$$Q_r = f(I_c)$$

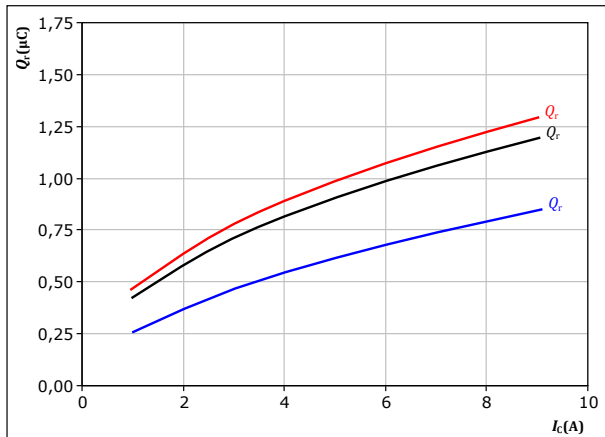

With an inductive load at

$V_{CE} = 600$ V
 $V_{GE} = 0/15$ V
 $R_{goff} = 64$ Ω

T_j : — 25 °C
— 125 °C
— 150 °C

figure 42. FWD

Typical recovered charge as a function of turn off gate resistor

$$Q_r = f(R_{goff})$$

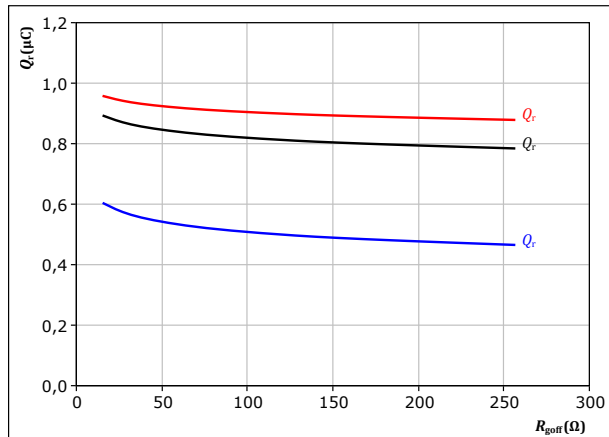

With an inductive load at

$V_{CE} = 600$ V
 $V_{GE} = 0/15$ V
 $I_c = 5$ A

T_j : — 25 °C
— 125 °C
— 150 °C

figure 43. FWD

Typical peak reverse recovery current as a function of collector current

$$I_{RM} = f(I_c)$$

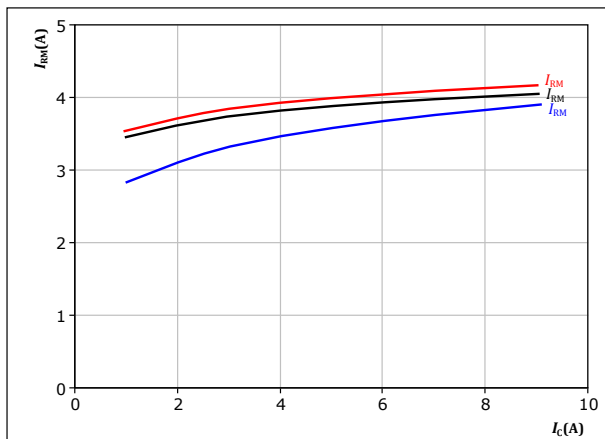

With an inductive load at

$V_{CE} = 600$ V
 $V_{GE} = 0/15$ V
 $R_{goff} = 64$ Ω

T_j : — 25 °C
— 125 °C
— 150 °C

figure 44. FWD

Typical peak reverse recovery current as a function of turn off gate resistor

$$I_{RM} = f(R_{goff})$$

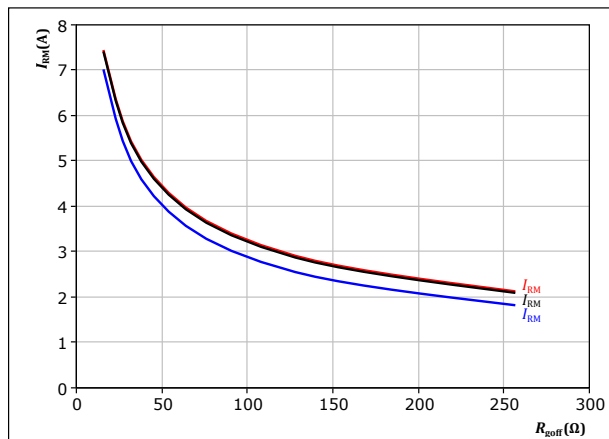

With an inductive load at

$V_{CE} = 600$ V
 $V_{GE} = 0/15$ V
 $I_c = 5$ A

T_j : — 25 °C
— 125 °C
— 150 °C



Brake Switching Characteristics

figure 45. FWD

Typical rate of fall of forward and reverse recovery current as a function of collector current
 $di_f/dt, di_r/dt = f(I_c)$

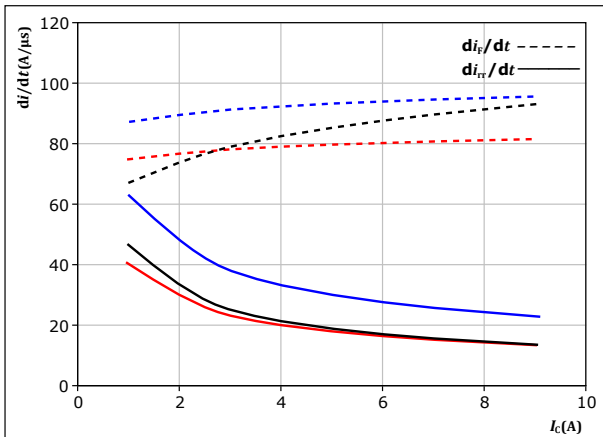

With an inductive load at
 $V_{CE} = 600 \text{ V}$
 $V_{GE} = 0/15 \text{ V}$
 $R_{goff} = 64 \text{ } \Omega$

T_j :
— 25 °C
— 125 °C
— 150 °C

figure 46. FWD

Typical rate of fall of forward and reverse recovery current as a function of turn off gate resistor
 $di_f/dt, di_r/dt = f(R_{goff})$

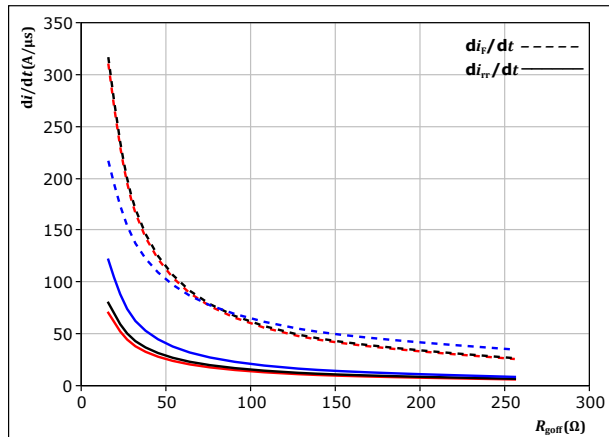

With an inductive load at
 $V_{CE} = 600 \text{ V}$
 $V_{GE} = 0/15 \text{ V}$
 $I_c = 5 \text{ A}$

T_j :
— 25 °C
— 125 °C
— 150 °C

figure 47. IGBT

Reverse bias safe operating area
 $I_c = f(V_{CE})$

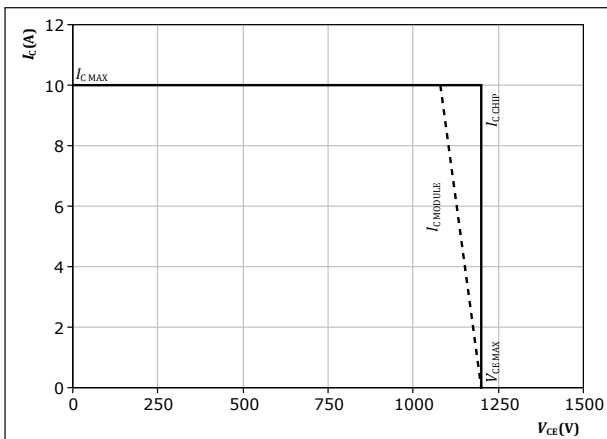

At $T_j = 150 \text{ } ^\circ\text{C}$
 $R_{goff} = 64 \text{ } \Omega$
 $R_{goff} = 64 \text{ } \Omega$



Switching Definitions

figure 48. IGBT
Turn-off Switching Waveforms & definition of t_{doff} , t_{Eoff} (t_{Eoff} = integrating time for E_{off})

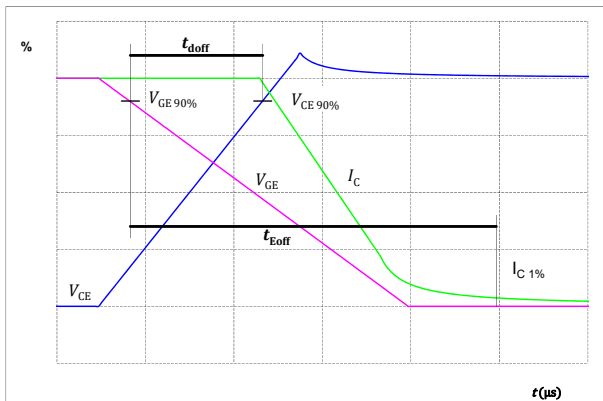

figure 49. IGBT
Turn-on Switching Waveforms & definition of t_{don} , t_{Eon} (t_{Eon} = integrating time for E_{on})

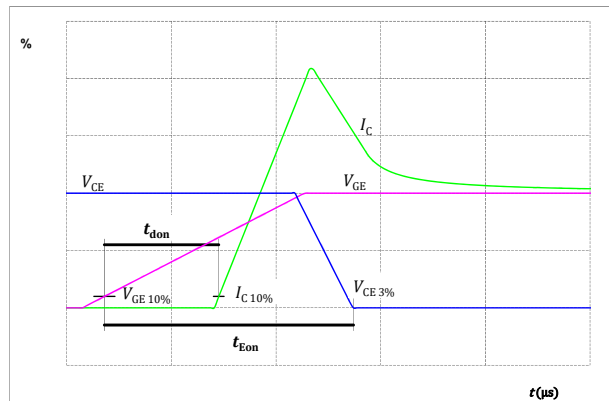

figure 50. IGBT
Turn-off Switching Waveforms & definition of t_f

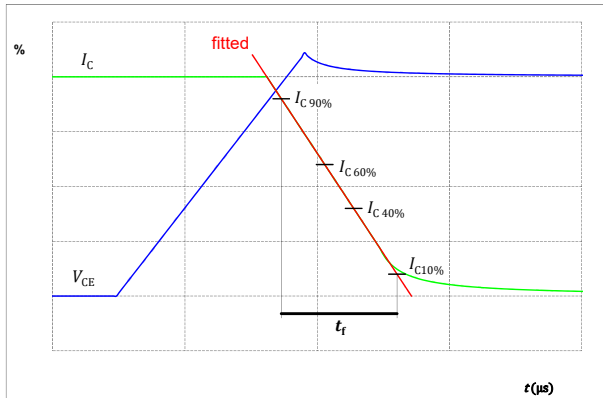
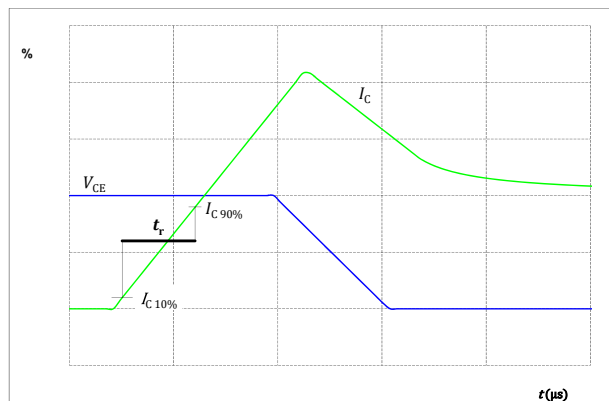

figure 51. IGBT
Turn-on Switching Waveforms & definition of t_r





Switching Definitions

figure 52. FWD

Turn-off Switching Waveforms & definition of t_{rr}

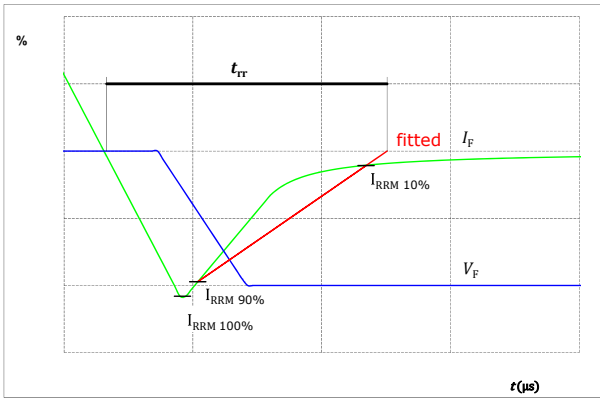
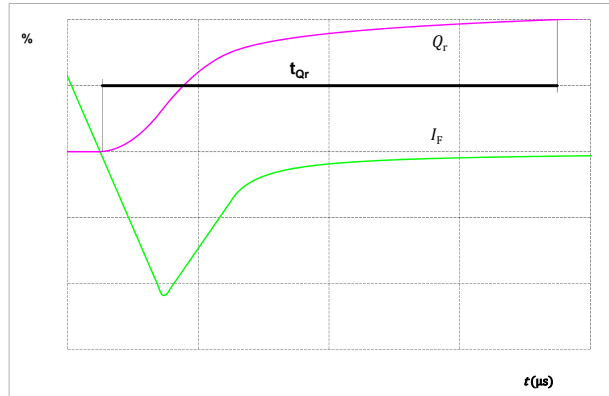

figure 53. FWD

Turn-on Switching Waveforms & definition of t_{Qr} (t_{Qr} = integrating time for Q_r)





Vincotech

10-F012PMA010M7-P849A29
datasheet

Ordering Code	
Version	Ordering Code
Without thermal paste	10-F012PMA010M7-P849A29
With thermal paste (5,2 W/mK, PTM6000HV)	10-F012PMA010M7-P849A29-/7/
With thermal paste (3,4 W/mK, PSX-P7)	10-F012PMA010M7-P849A29-/3/

Marking						
	Text	Name	Date code	UL & VIN	Lot	Serial
		NN-NNNNNNNNNNNNNN- TTTTTVV	WWYY	UL VIN	LLLLL	SSSS
Datamatrix	Type&Ver	Lot number	Serial	Date code		
	TTTTTVV	LLLLL	SSSS	WWYY		

Pin table [mm]			
Pin	X	Y	Function
1	25,5	2,7	Therm1
2	25,5	0	Therm2
3	22,8	0	DC-Rect
4	20,1	0	G27
5	16,2	0	DC-Br
6	13,5	0	G15
7	10,8	0	DC-3
8	8,1	0	G13
9	5,4	0	DC-2
10	2,7	0	G11
11	0	0	DC-1
12	0	19,8	G12
13	0	22,5	Ph1
14	7,5	19,8	G14
15	7,5	22,5	Ph2
16	15	19,8	G16
17	15	22,5	Ph3
18	22,8	22,5	DC+Inv
19	25,5	22,5	DC+Rect
20	33,5	22,5	Br
21	33,5	15	ACIn1
22	33,5	7,5	ACIn2
23	33,5	0	ACIn3

Tolerance of pinpositions: ±0.5mm at the end of pins
Dimension of coordinate axis is only offset without tolerance



Vincotech

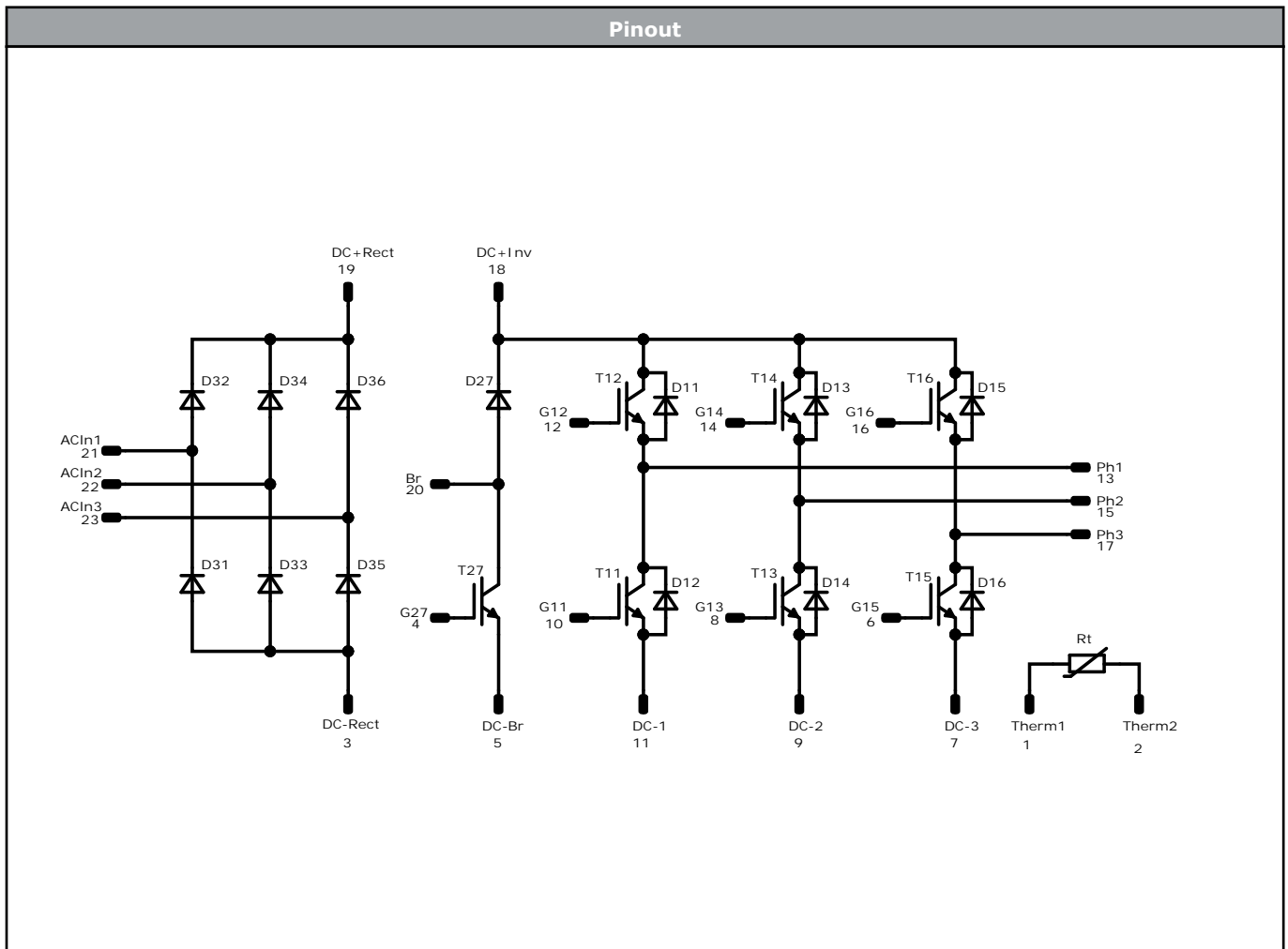

Identification					
ID	Component	Voltage	Current	Function	Comment
T11, T12, T13, T14, T15, T16	IGBT	1200 V	10 A	Inverter Switch	
D11, D12, D13, D14, D15, D16	FWD	1200 V	10 A	Inverter Diode	
T27	IGBT	1200 V	5 A	Brake Switch	
D27	FWD	1200 V	5 A	Brake Diode	
D31, D32, D33, D34, D35, D36	Rectifier	1600 V	25 A	Rectifier Diode	
Rt	NTC			Thermistor	



Packaging instruction				
Standard packaging quantity (SPQ) 135	>SPQ	Standard	<SPQ	Sample

Handling instruction
Handling instructions for <i>flow 0</i> packages see vincotech.com website.

Package data
Package data for <i>flow 0</i> packages see vincotech.com website.

Vincotech thermistor reference
See Vincotech thermistor reference table at vincotech.com website.

UL recognition and file number
This device is certified according to UL 1557 standard, UL file number E192116. For more information see vincotech.com website. 

Document No.:	Date:	Modification:	Pages
10-F012PMA010M7-P849A29-D5-14	30 Sep. 2021	New Datasheet format, module is unchanged Correct Thermal values of Inverter Diode Separate datasheet for pressfit pin version	

DISCLAIMER

The information, specifications, procedures, methods and recommendations herein (together "information") are presented by Vincotech to reader in good faith, are believed to be accurate and reliable, but may well be incomplete and/or not applicable to all conditions or situations that may exist or occur. Vincotech reserves the right to make any changes without further notice to any products to improve reliability, function or design. No representation, guarantee or warranty is made to reader as to the accuracy, reliability or completeness of said information or that the application or use of any of the same will avoid hazards, accidents, losses, damages or injury of any kind to persons or property or that the same will not infringe third parties rights or give desired results. It is reader's sole responsibility to test and determine the suitability of the information and the product for reader's intended use.

LIFE SUPPORT POLICY

Vincotech products are not authorised for use as critical components in life support devices or systems without the express written approval of Vincotech.

As used herein:

1. Life support devices or systems are devices or systems which, (a) are intended for surgical implant into the body, or (b) support or sustain life, or (c) whose failure to perform when properly used in accordance with instructions for use provided in labelling can be reasonably expected to result in significant injury to the user.
2. A critical component is any component of a life support device or system whose failure to perform can be reasonably expected to cause the failure of the life support device or system, or to affect its safety or effectiveness.