



*flowPIM 0 + PFC*

**600 V / 15 A**

**Features**

- Clip in PCB mounting
- Trench Fieldstop IGBT's for low saturation losses
- Latest generation superjunction MOSFET for PFC

**Target applications**

- Industrial Drives
- Embedded Drives

**Types**

- 10-F006PPA015SB-M684B

*flow 0 17 mm housing*

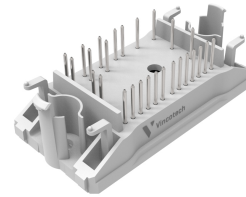

**Schematic**

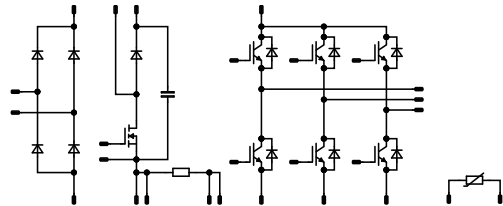



### Maximum Ratings

$T_j = 25\text{ °C}$ , unless otherwise specified

Parameter	Symbol	Conditions	Value	Unit
<b>Inverter Switch</b>				
Collector-emitter voltage	$V_{CES}$		600	V
Collector current	$I_C$	$T_j = T_{jmax}$ $T_s = 80\text{ °C}$	21	A
Repetitive peak collector current	$I_{CRM}$	$t_p$ limited by $T_{jmax}$	45	A
Total power dissipation	$P_{tot}$	$T_j = T_{jmax}$ $T_s = 80\text{ °C}$	52	W
Gate-emitter voltage	$V_{GES}$		$\pm 20$	V
Short circuit ratings	$i_{SC}$	$V_{GE} = 15\text{ V}$ , $V_{CC} = 360\text{ V}$ $T_j = 150\text{ °C}$	6	$\mu\text{s}$
Maximum junction temperature	$T_{jmax}$		175	$^{\circ}\text{C}$

<b>Inverter Diode</b>				
Peak repetitive reverse voltage	$V_{RRM}$		600	V
Continuous (direct) forward current	$I_F$	$T_j = T_{jmax}$ $T_s = 80\text{ °C}$	20	A
Repetitive peak forward current	$I_{FRM}$	$t_p$ limited by $T_{jmax}$	30	A
Total power dissipation	$P_{tot}$	$T_j = T_{jmax}$ $T_s = 80\text{ °C}$	35	W
Maximum junction temperature	$T_{jmax}$		175	$^{\circ}\text{C}$



Vincotech

**10-F006PPA015SB-M684B**  
datasheet

## Maximum Ratings

$T_j = 25\text{ °C}$ , unless otherwise specified

Parameter	Symbol	Conditions	Value	Unit
<b>PFC Switch</b>				
Drain-source voltage	$V_{DS}$		600	V
Drain current	$I_D$	$T_j = T_{jmax}$ $T_s = 80\text{ °C}$	23	A
Peak drain current	$I_{DM}$	$t_p$ limited by $T_{jmax}$	159	A
Avalanche energy, single pulse	$E_{AS}$	$V_{DD} = 50\text{ V}$ $I_D = 9,3\text{ A}$	1135	mJ
Avalanche energy, repetitive	$E_{AR}$	$V_{DD} = 50\text{ V}$ $I_D = 9,3\text{ A}$	1,72	mJ
Avalanche current, repetitive	$I_{AR}$	$t_p$ limited by $T_{jmax}$ $P_{AV} = E_{AR} * f$	9,3	A
MOSFET dv/dt ruggedness	dv/dt	$V_{DS} = 480\text{ V}$ $T_s = 25\text{ °C}$	50	V/ns
Total power dissipation	$P_{tot}$	$T_j = T_{jmax}$ $T_s = 80\text{ °C}$	90	W
Gate-source voltage	$V_{GSS}$		±20	V
Maximum Junction Temperature	$T_{jmax}$		150	°C

## PFC Diode

Peak repetitive reverse voltage	$V_{RRM}$		600	V
Continuous (direct) forward current	$I_F$	$T_j = T_{jmax}$ $T_s = 80\text{ °C}$	32	A
Surge (non-repetitive) forward current	$I_{FSM}$	Single Half Sine Wave, $t_p = 8,3\text{ ms}$ $T_j = 25\text{ °C}$	300	A
Total power dissipation	$P_{tot}$	$T_j = T_{jmax}$ $T_s = 80\text{ °C}$	52	W
Maximum junction temperature	$T_{jmax}$		175	°C

## Rectifier Diode

Peak repetitive reverse voltage	$V_{RRM}$		1600	V
Forward average current	$I_{FAV}$	$T_j = T_{jmax}$ $T_s = 80\text{ °C}$	33	A
Surge (non-repetitive) forward current	$I_{FSM}$	Single Half Sine Wave, $t_p = 10\text{ ms}$ $T_j = 150\text{ °C}$	200	A
Surge current capability	$I^2t$		200	A <sup>2</sup> s
Total power dissipation	$P_{tot}$	$T_j = T_{jmax}$ $T_s = 80\text{ °C}$	44	W
Maximum junction temperature	$T_{jmax}$		150	°C



Vincotech

**10-F006PPA015SB-M684B**  
datasheet

## Maximum Ratings

$T_j = 25\text{ °C}$ , unless otherwise specified

Parameter	Symbol	Conditions	Value	Unit
<b>PFC Shunt</b>				
DC current	$I$	$T_c = 70\text{ °C}$	22	A
Power dissipation	$P_{tot}$	$T_c = 70\text{ °C}$	5	W
Operation Temperature	$T_{op}$		-55 ... 170	°C

## Capacitor (PFC)

Maximum DC voltage	$V_{MAX}$		500	V
Operation Temperature	$T_{op}$		-55 ... 125	°C

## Module Properties

### Thermal Properties

Storage temperature	$T_{stg}$		-40...+125	°C
Operation temperature under switching condition	$T_{jop}$		-40...+( $T_{jmax} - 25$ )	°C

### Isolation Properties

Isolation voltage	$V_{isol}$	DC Test Voltage* $t_p = 2\text{ s}$	6000	V
Isolation voltage	$V_{isol}$	AC Voltage $t_p = 1\text{ min}$	2500	V
Creepage distance			min. 12,7	mm
Clearance			min, 12,7	mm
Comparative Tracking Index	CTI		$\geq 200$	

\*100 % tested in production



### Characteristic Values

Parameter	Symbol	Conditions					Values			Unit
		$V_{GS}$ [V]	$V_{GE}$ [V]	$V_{DS}$ [V]	$I_C$ [A]	$T_j$ [°C]	Min	Typ	Max	

#### Inverter Switch

##### Static

Gate-emitter threshold voltage	$V_{GE(th)}$	$V_{CE} = V_{GE}$			0,00021	25	5	5,8	6,5	V
Collector-emitter saturation voltage	$V_{CE(sat)}$		15		15	25	1,1	1,59	1,9 <sup>(1)</sup>	V
Collector-emitter cut-off current	$I_{CES}$		0	600		25			28	μA
Gate-emitter leakage current	$I_{GES}$		20	0		25			300	nA
Internal gate resistance	$r_g$							None		Ω
Input capacitance	$C_{ies}$							800		pF
Output capacitance	$C_{oes}$	$f = 1$ Mhz	0	25		25		55		pF
Reverse transfer capacitance	$C_{res}$							24		pF
Gate charge	$Q_g$		15		0	25		87		nC

##### Thermal

Thermal resistance junction to sink <sup>(2)</sup>	$R_{th(j-s)}$	$\lambda_{paste} = 3,4$ W/mK (PSX)						1,83		K/W
--	---------------	------------------------------------	--	--	--	--	--	------	--	-----

##### Dynamic

Turn-on delay time	$t_{d(on)}$					25 125 150		102 101,4 101		ns
Rise time	$t_r$	$R_{gon} = 32$ Ω $R_{goff} = 32$ Ω				25 125 150		28,8 31 31,4		ns
Turn-off delay time	$t_{d(off)}$		±15	400	15	25 125 150		156,6 178,6 181,4		ns
Fall time	$t_f$					25 125 150		61,75 71,56 85,28		ns
Turn-on energy (per pulse)	$E_{on}$	$Q_{tFWD} = 0,646$ μC $Q_{tFWD} = 1,3$ μC $Q_{tFWD} = 1,53$ μC				25 125 150		0,482 0,678 0,693		mWs
Turn-off energy (per pulse)	$E_{off}$					25 125 150		0,426 0,553 0,598		mWs



Vincotech

### Characteristic Values

Parameter	Symbol	Conditions					Values			Unit
		$V_{GE}$ [V] $V_{GS}$ [V]	$V_{CE}$ [V] $V_{DS}$ [V] $V_F$ [V]	$I_C$ [A] $I_D$ [A] $I_F$ [A]	$T_j$ [°C]	Min	Typ	Max		

#### Inverter Diode

##### Static

Forward voltage	$V_F$				15	25 150	1,25	1,6 1,51	1,95 <sup>(1)</sup>	V
Reverse leakage current	$I_R$	$V_i = 600$ V				25			27	μA

##### Thermal

Thermal resistance junction to sink <sup>(2)</sup>	$R_{th(j-s)}$	$\lambda_{paste} = 3,4$ W/mK (PSX)						2,75		K/W
--	---------------	---------------------------------------	--	--	--	--	--	------	--	-----

##### Dynamic

Peak recovery current	$I_{RRM}$	$di/dt=446$ A/μs $di/dt=490$ A/μs $di/dt=382$ A/μs	±15	400	15	25		5,96		A
Reverse recovery time	$t_{rr}$					125		7,85	ns	
						150		8,52		
						25		231,41		
Recovered charge	$Q_r$					125		308,74	μC	
						150		350		
		25		0,646						
Reverse recovered energy	$E_{rec}$	125		1,3	mWs					
		150		1,53						
		25		0,178						
Peak rate of fall of recovery current	$(di_{rr}/dt)_{max}$	125		0,353	A/μs					
		150		0,431						
		25		20,77						
						125		43,15		
						150		51,04		



### Characteristic Values

Parameter	Symbol	Conditions					Values			Unit
		$V_{GE}$ [V] $V_{GS}$ [V]	$V_{CE}$ [V] $V_{DS}$ [V] $V_F$ [V]	$I_C$ [A] $I_D$ [A] $I_F$ [A]	$T_j$ [°C]	Min	Typ	Max		

#### PFC Switch

##### Static

Drain-source on-state resistance	$r_{DS(on)}$		10		25	25 125		70 150	80	mΩ
Gate-source threshold voltage	$V_{GS(th)}$		0		0,00172	25	2,4	3	3,6	V
Gate to Source Leakage Current	$I_{GSS}$		20	0		25			100	nA
Zero Gate Voltage Drain Current	$I_{DSS}$		0	600		25			5	μA
Internal gate resistance	$r_g$							0,85		Ω
Gate charge	$Q_g$	$V_{DD} = 480 V$	10		25,8	25		170		nC
Short-circuit input capacitance	$C_{iss}$	$f = 1 Mhz$	0	100	0	25		3800		pF
Short-circuit output capacitance	$C_{oss}$							215		

##### Thermal

Thermal resistance junction to sink <sup>(2)</sup>	$R_{th(j-s)}$	$\lambda_{paste} = 3,4 W/mK$ (PSX)						0,78		K/W
--	---------------	---------------------------------------	--	--	--	--	--	------	--	-----

##### Dynamic

Turn-on delay time	$t_{d(on)}$	$R_{gon} = 8 \Omega$ $R_{goff} = 8 \Omega$	-5/10	400	15	25		38,2		ns
						125		43,6		
						150		24,6		
Rise time	$t_r$					25		4,8		
						125		5,8		
						150		7		
Turn-off delay time	$t_{d(off)}$					25		130,2		
		125		136						
		150		250,4						
Fall time	$t_f$	25		10,51						
		125		13,88						
		150		5,36						
Turn-on energy (per pulse)	$E_{on}$	$Q_{tFWD} = 0,253 \mu C$ $Q_{tFWD} = 0,585 \mu C$ $Q_{tFWD} = 0,786 \mu C$				25		0,136		mWs
						125		0,208		
						150		0,345		
Turn-off energy (per pulse)	$E_{off}$					25		0,042		mWs
						125		0,053		
						150		0,12		



Vincotech

**10-F006PPA015SB-M684B**  
datasheet

### Characteristic Values

Parameter	Symbol	Conditions					Values			Unit
		$V_{GE}$ [V] $V_{GS}$ [V]	$V_{CE}$ [V] $V_{DS}$ [V] $V_F$ [V]	$I_C$ [A] $I_D$ [A] $I_F$ [A]	$T_j$ [°C]	Min	Typ	Max		
<b>PFC Diode</b>										
<b>Static</b>										
Forward voltage	$V_F$				30	25 125 150	1,88	2,32 1,78 1,67	2,78 <sup>(1)</sup>	V
Reverse leakage current	$I_R$	$V_r = 600$ V				25 125			10 500	μA
<b>Thermal</b>										
Thermal resistance junction to sink <sup>(2)</sup>	$R_{th(j-s)}$	$\lambda_{paste} = 3,4$ W/mK (PSX)						1,81		K/W
<b>Dynamic</b>										
Peak recovery current	$I_{RRM}$					25 125 150		29,17 43,07 45,18		A
Reverse recovery time	$t_{rr}$					25 125 150		13,71 24,66 29,89		ns
Recovered charge	$Q_r$	$di/dt=2946$ A/μs $di/dt=2625$ A/μs $di/dt=2104$ A/μs	-5/10	400	15	25 125 150		0,253 0,585 0,786		μC
Reverse recovered energy	$E_{rec}$					25 125 150		0,046 0,185 0,125		mWs
Peak rate of fall of recovery current	$(di_r/dt)_{max}$					25 125 150		8586 6089 4643		A/μs





Vincotech

### Characteristic Values

Parameter	Symbol	Conditions					Values			Unit
		$V_{GE}$ [V] $V_{GS}$ [V]	$V_{CE}$ [V] $V_{DS}$ [V] $V_F$ [V]	$I_C$ [A] $I_D$ [A] $I_F$ [A]	$T_j$ [°C]	Min	Typ	Max		

#### Rectifier Diode

##### Static

Forward voltage	$V_F$				25	25 125		1,22 1,2	1,75	V
Reverse leakage current	$I_R$	$V_i = 1600$ V				25			50	$\mu$ A

##### Thermal

Thermal resistance junction to sink <sup>(2)</sup>	$R_{th(j-s)}$	$\lambda_{paste} = 3,4$ W/mK (PSX)						1,59		K/W
--	---------------	---------------------------------------	--	--	--	--	--	------	--	-----

#### PFC Shunt

##### Static

Resistance	$R$							10		m $\Omega$
Tolerance							-1		1	%
Temperature coefficient	tc								30	ppm/K

#### Capacitor (PFC)

##### Static

Capacitance	$C$							100		nF
Tolerance							-10		10	%
Dissipation factor		$f = 1$ kHz				25		2,5		%



Vincotech

### Characteristic Values

Parameter	Symbol	Conditions					Values			Unit
		$V_{GS}$ [V]	$V_{GE}$ [V]	$V_{DS}$ [V]	$V_{CE}$ [V]	$T_j$ [°C]	Min	Typ	Max	

### Thermistor

#### Static

Rated resistance	$R$					25		22		kΩ
Deviation of $R_{100}$	$A_{R/R}$	$R_{100} = 1484 \Omega$				100	-5		5	%
Power dissipation	$P$							5		mW
Power dissipation constant	$d$					25		1,5		mW/K
B-value	$B_{(25/50)}$	Tol. $\pm 1 \%$						3962		K
B-value	$B_{(25/100)}$	Tol. $\pm 1 \%$						4000		K
Vincotech Thermistor Reference									I	

<sup>(1)</sup> Value at chip level

<sup>(2)</sup> Only valid with pre-applied Vincotech thermal interface material.



## Inverter Switch Characteristics

**figure 1.** IGBT

Typical output characteristics

$$I_C = f(V_{CE})$$

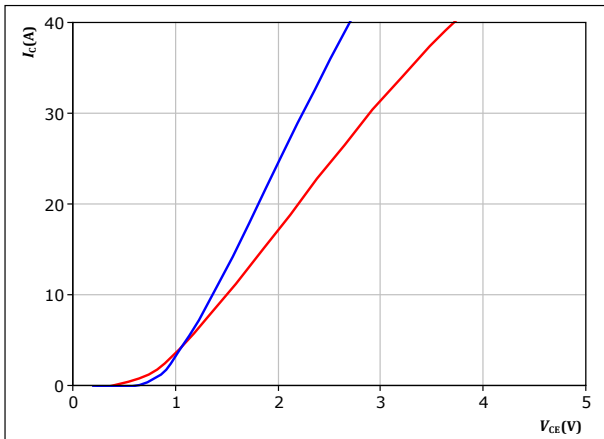

$t_p = 250\text{ }\mu\text{s}$   
 $V_{GE} = 15\text{ V}$   
 $T_j: 25\text{ }^\circ\text{C}$  (blue),  $150\text{ }^\circ\text{C}$  (red)

**figure 2.** IGBT

Typical output characteristics

$$I_C = f(V_{CE})$$

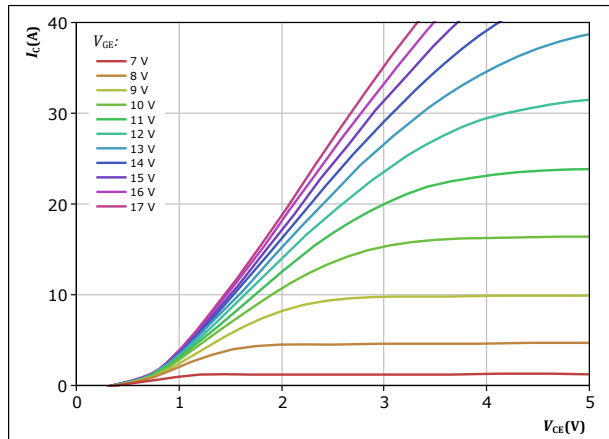

$t_p = 250\text{ }\mu\text{s}$   
 $T_j = 150\text{ }^\circ\text{C}$   
 $V_{GE}$  from 7 V to 17 V in steps of 1 V

**figure 3.** IGBT

Typical transfer characteristics

$$I_C = f(V_{GE})$$

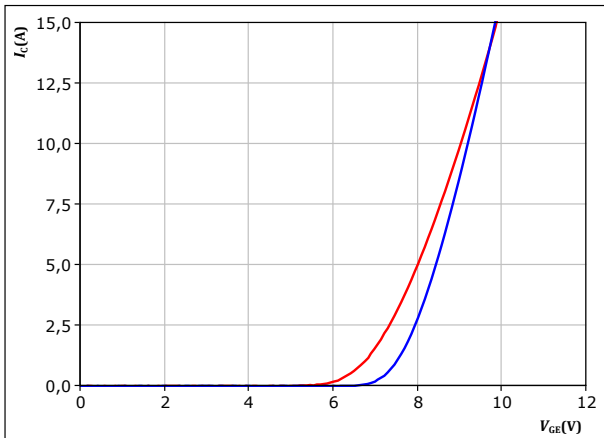

$t_p = 250\text{ }\mu\text{s}$   
 $V_{CE} = 10\text{ V}$   
 $T_j: 25\text{ }^\circ\text{C}$  (blue),  $150\text{ }^\circ\text{C}$  (red)

**figure 4.** IGBT

Short circuit withstand time as a function of  $V_{GE}$

$$t_{sc} = f(V_{GE})$$

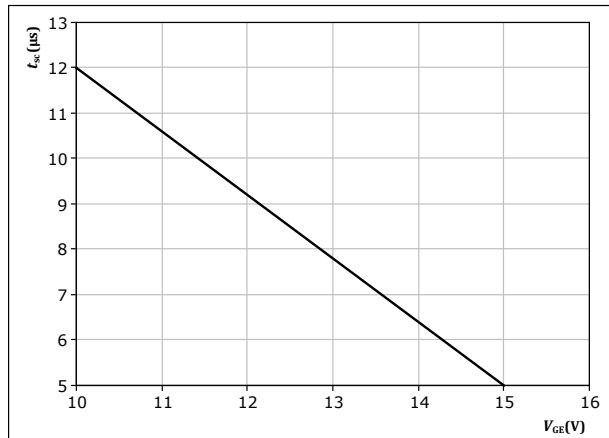

At  $V_{CE} = \text{V}$   
 $T_j \leq \text{ }^\circ\text{C}$



## Inverter Switch Characteristics

**figure 5.** IGBT

Typical short circuit current as a function of  $V_{GE}$   
Missing:  $I_{SC} = f(V_{GE})$

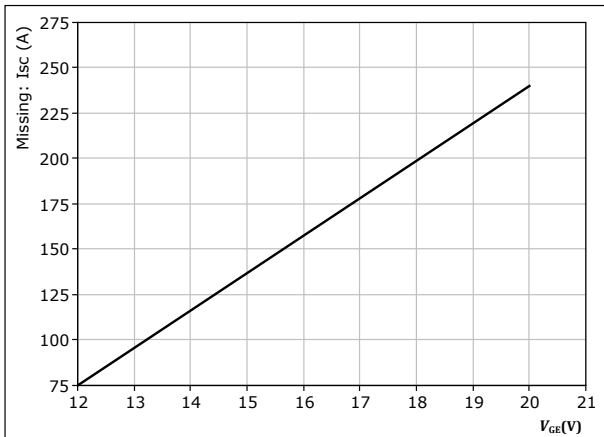

At  $T_j \leq$  °C

**figure 6.** IGBT

Transient thermal impedance as a function of pulse width  
 $Z_{th(j-s)} = f(t_p)$

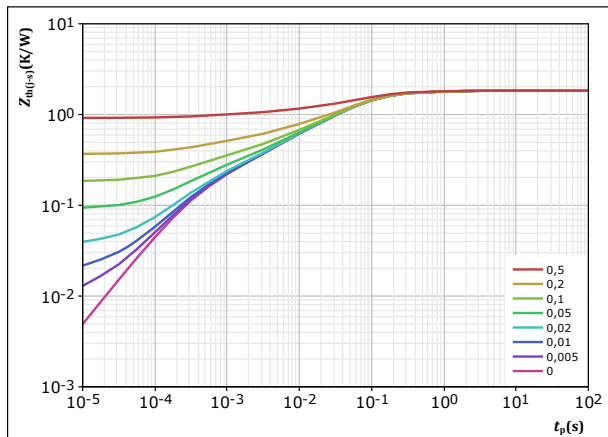

$D = t_p / T$   
 $R_{th(j-s)} = 1,834$  K/W  
IGBT thermal model values

$R$ (K/W)	$\tau$ (s)
8,30E-02	1,29E+00
3,76E-01	1,56E-01
8,46E-01	5,15E-02
2,81E-01	8,16E-03
1,16E-01	2,04E-03
1,32E-01	3,43E-04

**figure 7.** IGBT

Safe operating area  
 $I_C = f(V_{CE})$

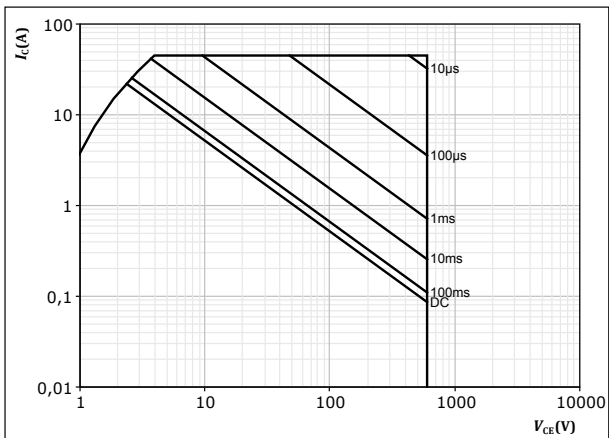

$D =$  single pulse  
 $T_j = 80$  °C  
 $V_{GE} = 15$  V  
 $T_j = T_{jmax}$

**figure 8.** IGBT

Gate voltage vs gate charge  
 $V_{GE} = f(Q_g)$

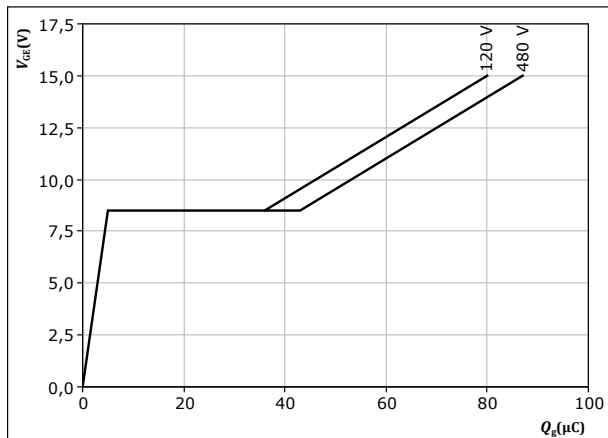

At  $I_C = 15$  A



## Inverter Diode Characteristics

**figure 9.** FWD

Typical forward characteristics

$$I_F = f(V_F)$$

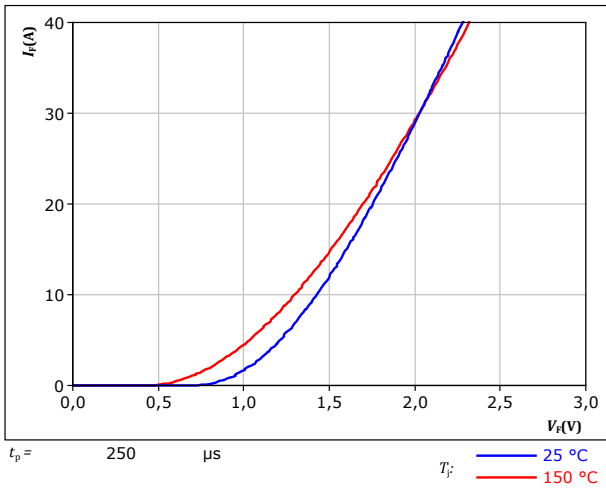

**figure 10.** FWD

Transient thermal impedance as a function of pulse width

$$Z_{th(j-s)} = f(t_p)$$

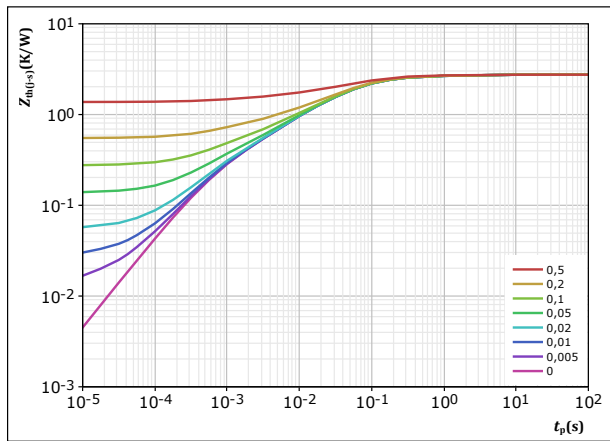

$D = t_p / T$

$R_{th(j-s)} = 2,75 \text{ K/W}$

FWD thermal model values

$R \text{ (K/W)}$	$\tau \text{ (s)}$
1,03E-01	3,14E+00
3,03E-01	2,74E-01
1,23E+00	6,07E-02
5,94E-01	1,63E-02
3,18E-01	4,11E-03
2,02E-01	6,37E-04



### PFC Switch Characteristics

figure 11. MOSFET

Typical output characteristics  
 $I_D = f(V_{DS})$

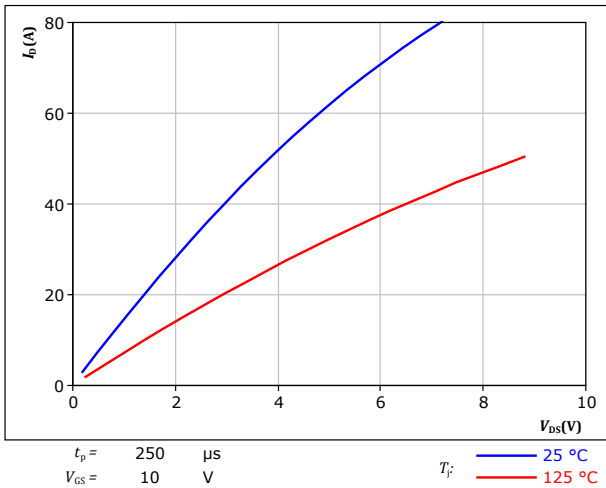

figure 12. MOSFET

Typical output characteristics  
 $I_D = f(V_{DS})$

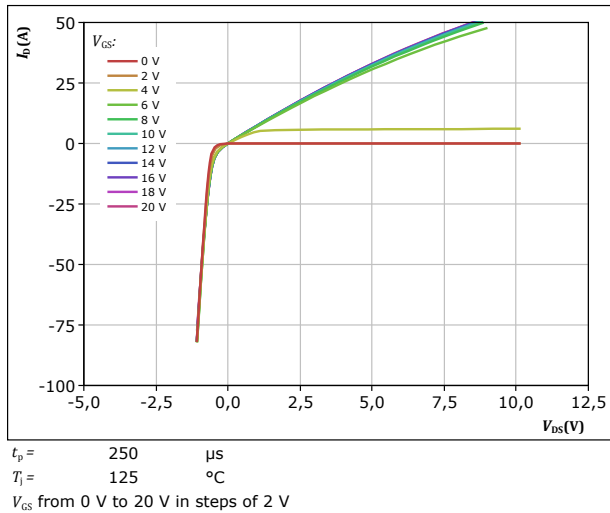

figure 13. MOSFET

Typical transfer characteristics  
 $I_D = f(V_{GS})$

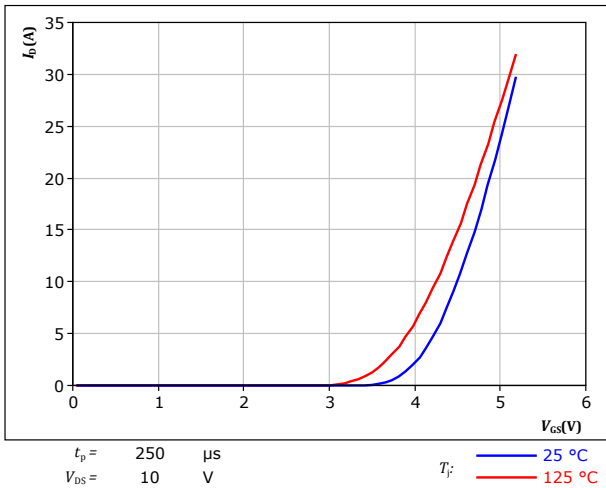
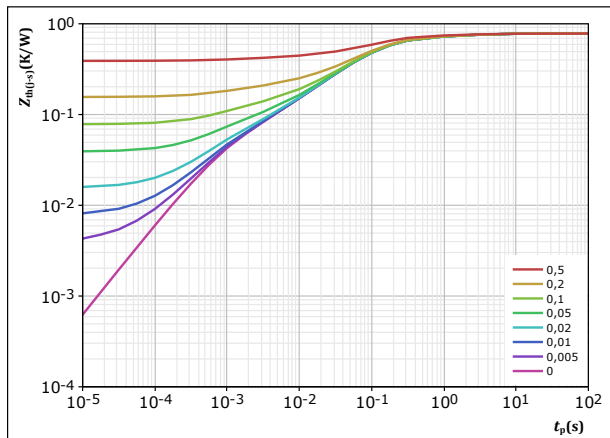

figure 14. MOSFET

Transient thermal impedance as a function of pulse width  
 $Z_{th(j-s)} = f(t_p)$



$D = t_p / T$   
 $R_{th(j-s)} = 0,78 \text{ K/W}$

MOSFET thermal model values

R (K/W)	$\tau$ (s)
4,90E-02	3,64E+00
1,03E-01	5,74E-01
4,25E-01	1,04E-01
1,20E-01	2,91E-02
4,27E-02	6,05E-03
4,10E-02	8,69E-04



### PFC Switch Characteristics

figure 15. MOSFET

Safe operating area  
 $I_C = f(V_{CE})$

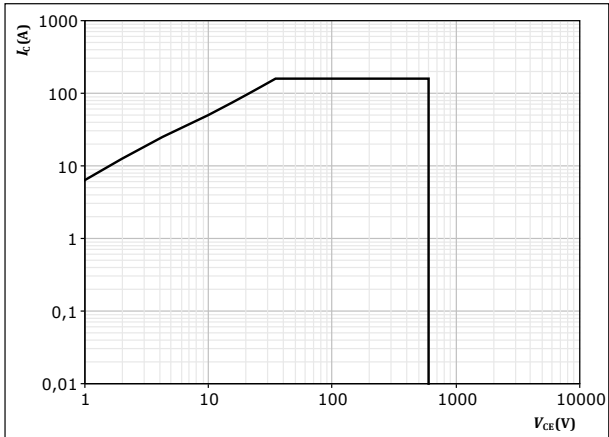

$D =$  single pulse  
 $T_s = 80$  °C  
 $V_{CE} = 10$  V  
 $T_j = T_{jmax}$

figure 16. MOSFET

Gate voltage vs gate charge  
 $V_{GS} = f(Q_g)$

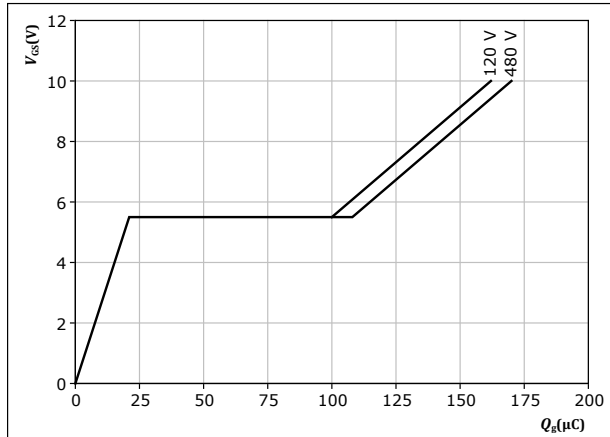

At  $I_0 = 25$  A



### PFC Diode Characteristics

**figure 17.** FWD

Typical forward characteristics

$$I_F = f(V_F)$$

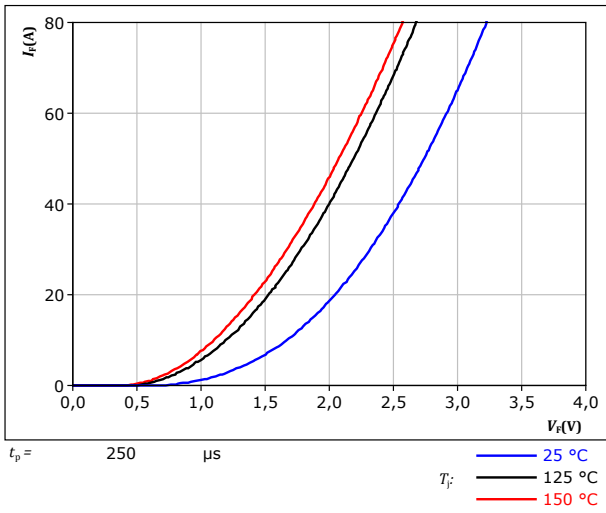

**figure 18.** FWD

Transient thermal impedance as a function of pulse width

$$Z_{th(j-s)} = f(t_p)$$

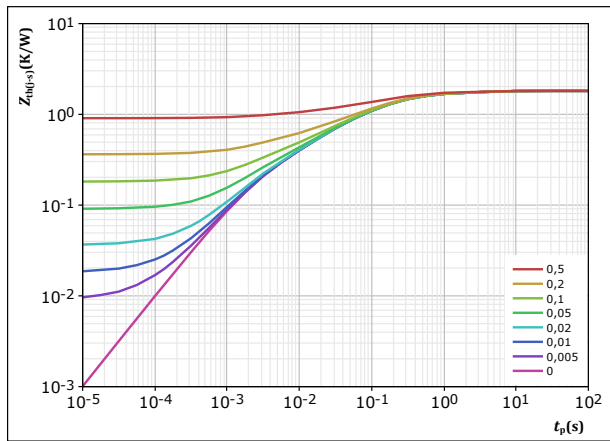

$D = \frac{t_p}{T}$   
 $R_{th(j-s)} = 1,814 \text{ K/W}$   
 FWD thermal model values

R (K/W)	$\tau$ (s)
1,53E-01	3,12E+00
5,19E-01	3,17E-01
6,76E-01	7,98E-02
3,13E-01	1,47E-02
1,53E-01	2,20E-03





## Rectifier Diode Characteristics

**figure 19.** Rectifier

Typical forward characteristics

$$I_F = f(V_F)$$

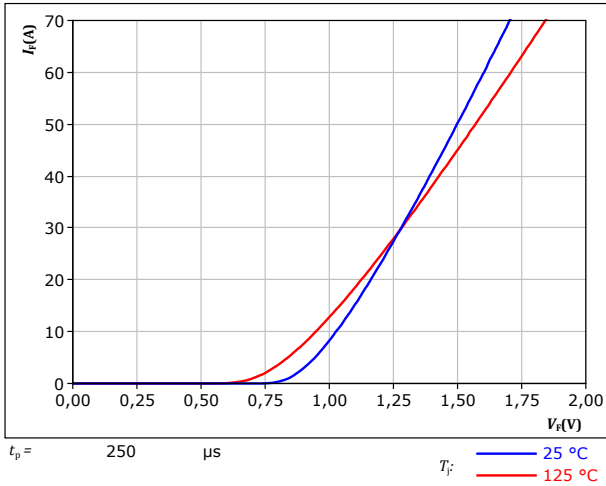

**figure 20.** Rectifier

Transient thermal impedance as a function of pulse width

$$Z_{th(j-s)} = f(t_p)$$

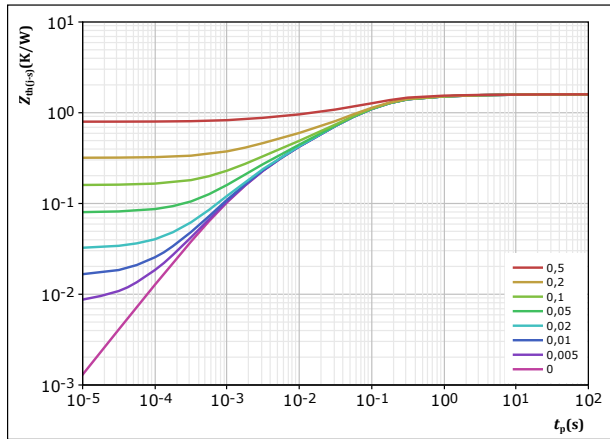

$D = \frac{t_p}{T}$   
 $R_{th(j-s)} = 1,594 \text{ K/W}$

Rectifier thermal model values

$R$ (K/W)	$\tau$ (s)
3,44E-02	9,66E+00
1,12E-01	1,22E+00
5,81E-01	1,45E-01
4,89E-01	5,05E-02
2,38E-01	9,26E-03
1,22E-01	1,79E-03
1,81E-02	7,88E-04



## Thermistor Characteristics

figure 21. Thermistor

Typical NTC characteristic as function of temperature

$$R_T = f(T)$$

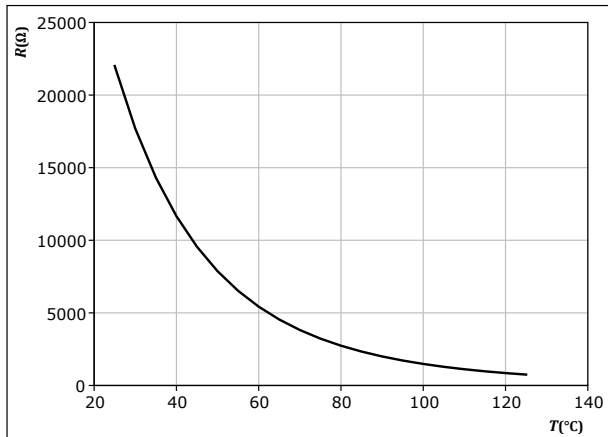



## Inverter Switching Characteristics

**figure 22.** IGBT

Typical switching energy losses as a function of collector current  
 $E = f(I_c)$

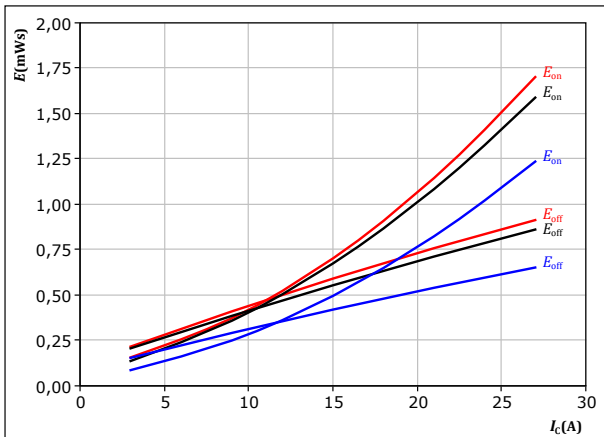

With an inductive load at  
 $V_{CE} = 400$  V  
 $V_{GE} = \pm 15$  V  
 $R_{gon} = 32$   $\Omega$   
 $R_{goff} = 32$   $\Omega$

$T_j$ : — 25 °C  
 — 125 °C  
 — 150 °C

**figure 23.** IGBT

Typical switching energy losses as a function of gate resistor  
 $E = f(R_g)$

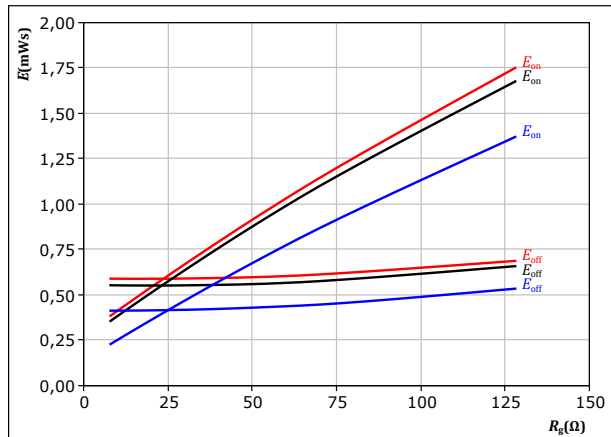

With an inductive load at  
 $V_{CE} = 400$  V  
 $V_{GE} = \pm 15$  V  
 $I_c = 15$  A

$T_j$ : — 25 °C  
 — 125 °C  
 — 150 °C

**figure 24.** FWD

Typical reverse recovered energy loss as a function of collector current  
 $E_{rec} = f(I_c)$

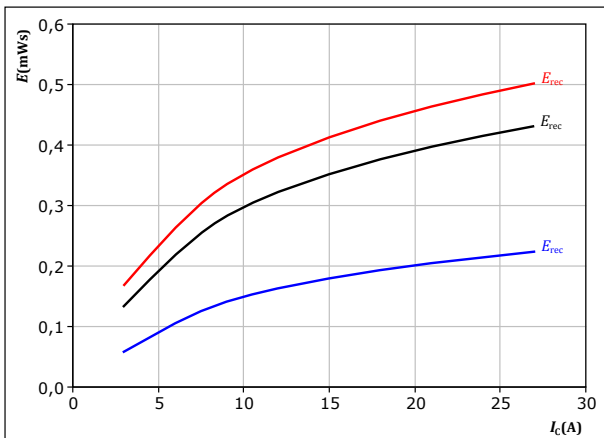

With an inductive load at  
 $V_{CE} = 400$  V  
 $V_{GE} = \pm 15$  V  
 $R_{gon} = 32$   $\Omega$

$T_j$ : — 25 °C  
 — 125 °C  
 — 150 °C

**figure 25.** FWD

Typical reverse recovered energy loss as a function of gate resistor  
 $E_{rec} = f(R_g)$

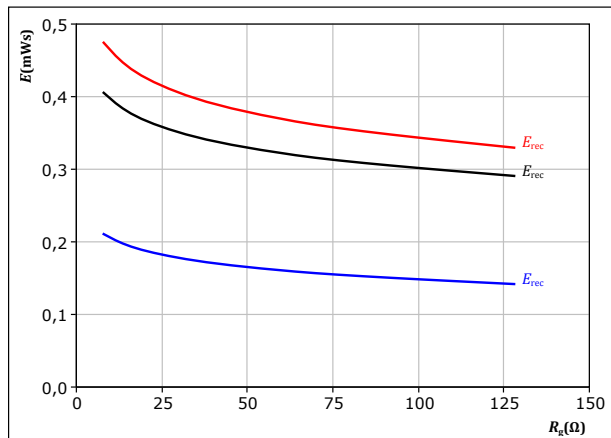

With an inductive load at  
 $V_{CE} = 400$  V  
 $V_{GE} = \pm 15$  V  
 $I_c = 15$  A

$T_j$ : — 25 °C  
 — 125 °C  
 — 150 °C



## Inverter Switching Characteristics

figure 26. IGBT

Typical switching times as a function of collector current  
 $t = f(I_c)$

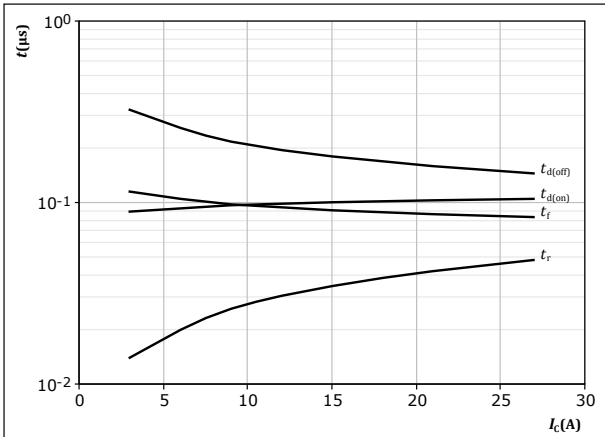

With an inductive load at  
 $T_j = 150 \text{ } ^\circ\text{C}$   
 $V_{CE} = 400 \text{ V}$   
 $V_{GE} = \pm 15 \text{ V}$   
 $R_{gon} = 32 \text{ } \Omega$   
 $R_{goff} = 32 \text{ } \Omega$

figure 27. IGBT

Typical switching times as a function of gate resistor  
 $t = f(R_g)$

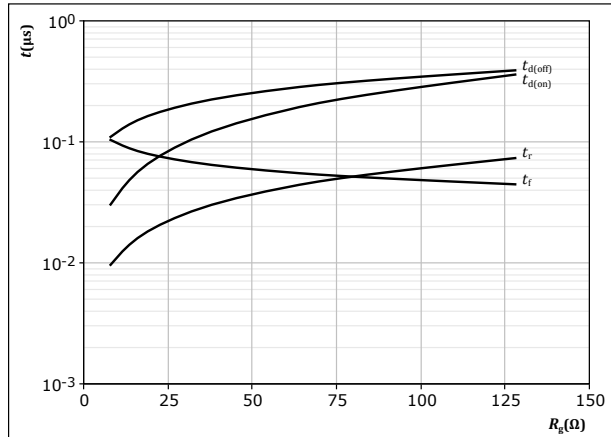

With an inductive load at  
 $T_j = 150 \text{ } ^\circ\text{C}$   
 $V_{CE} = 400 \text{ V}$   
 $V_{GE} = \pm 15 \text{ V}$   
 $I_c = 15 \text{ A}$

figure 28. FWD

Typical reverse recovery time as a function of collector current  
 $t_{rr} = f(I_c)$

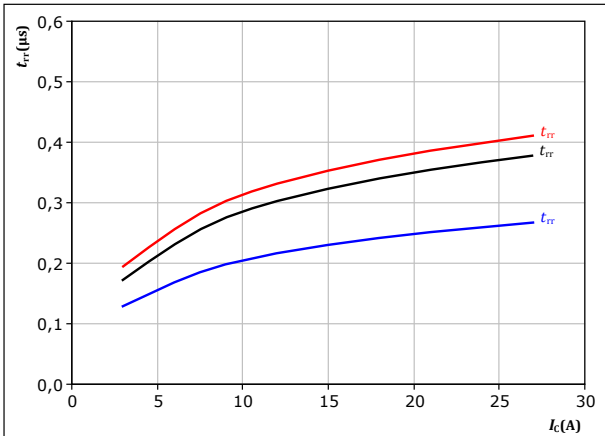

With an inductive load at  
 $V_{CE} = 400 \text{ V}$   
 $V_{GE} = \pm 15 \text{ V}$   
 $R_{gon} = 32 \text{ } \Omega$   
 $T_j:$  — 25 °C  
 — 125 °C  
 — 150 °C

figure 29. FWD

Typical reverse recovery time as a function of IGBT turn on gate resistor  
 $t_{rr} = f(R_{gon})$

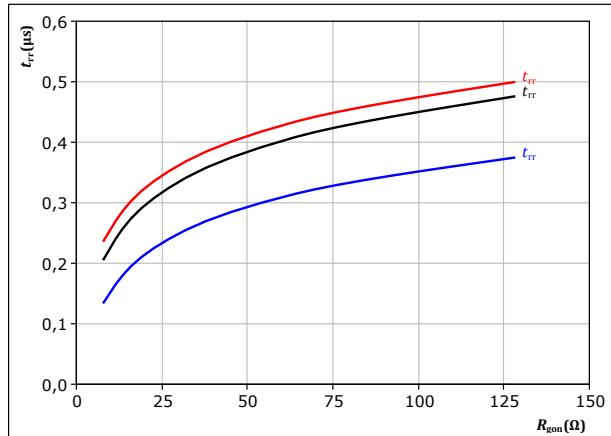

With an inductive load at  
 $V_{CE} = 400 \text{ V}$   
 $V_{GE} = \pm 15 \text{ V}$   
 $I_c = 15 \text{ A}$   
 $T_j:$  — 25 °C  
 — 125 °C  
 — 150 °C



## Inverter Switching Characteristics

**figure 30.** FWD

Typical recovered charge as a function of collector current

$$Q_r = f(I_c)$$

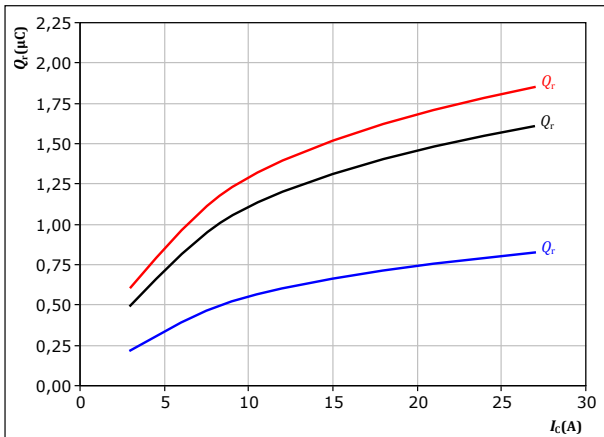

With an inductive load at

$V_{CE} = 400$  V  
 $V_{GE} = \pm 15$  V  
 $R_{gon} = 32$  Ω  
 $T_j$ : 25 °C (blue), 125 °C (black), 150 °C (red)

**figure 32.** FWD

Typical peak reverse recovery current as a function of collector current

$$I_{RM} = f(I_c)$$

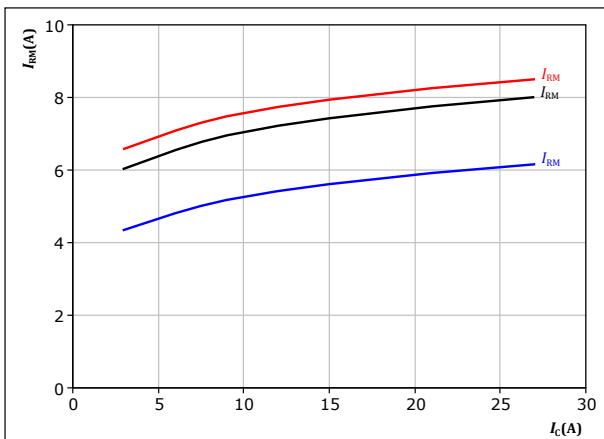

With an inductive load at

$V_{CE} = 400$  V  
 $V_{GE} = \pm 15$  V  
 $R_{gon} = 32$  Ω  
 $T_j$ : 25 °C (blue), 125 °C (black), 150 °C (red)

**figure 31.** FWD

Typical recovered charge as a function of turn on gate resistor

$$Q_r = f(R_{gon})$$

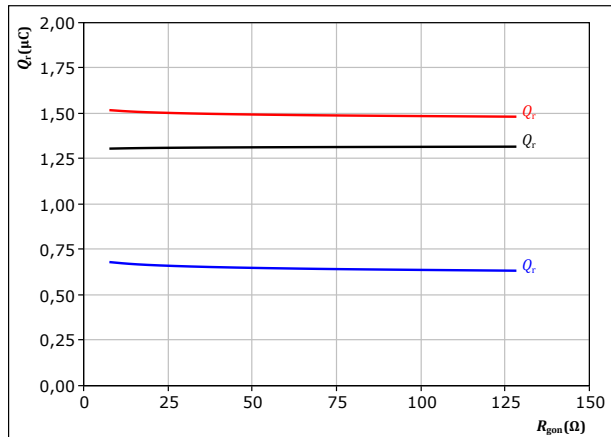

With an inductive load at

$V_{CE} = 400$  V  
 $V_{GE} = \pm 15$  V  
 $I_c = 15$  A  
 $T_j$ : 25 °C (blue), 125 °C (black), 150 °C (red)

**figure 33.** FWD

Typical peak reverse recovery current as a function of turn on gate resistor

$$I_{RM} = f(R_{gon})$$

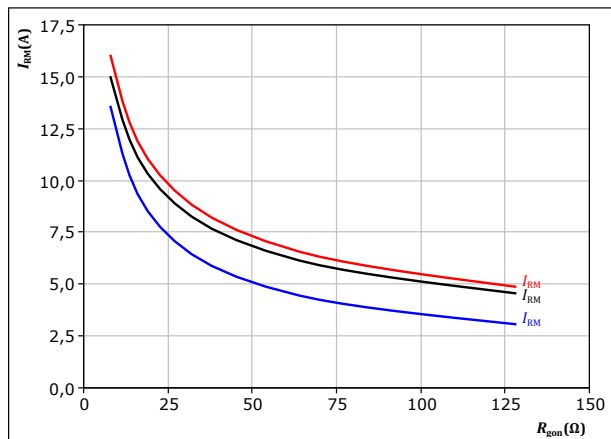

With an inductive load at

$V_{CE} = 400$  V  
 $V_{GE} = \pm 15$  V  
 $I_c = 15$  A  
 $T_j$ : 25 °C (blue), 125 °C (black), 150 °C (red)



## Inverter Switching Characteristics

**figure 34.** FWD

Typical rate of fall of forward and reverse recovery current as a function of collector current  
 $di_f/dt, di_r/dt = f(I_c)$

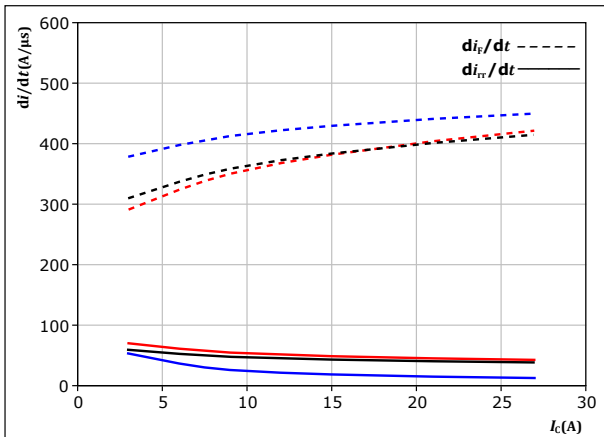

With an inductive load at

$V_{CE} = 400$ V	$T_j = 25$ °C
$V_{GE} = \pm 15$ V	$T_j = 125$ °C
$R_{gon} = 32$ Ω	$T_j = 150$ °C

**figure 35.** FWD

Typical rate of fall of forward and reverse recovery current as a function of turn on gate resistor  
 $di_f/dt, di_r/dt = f(R_{gon})$

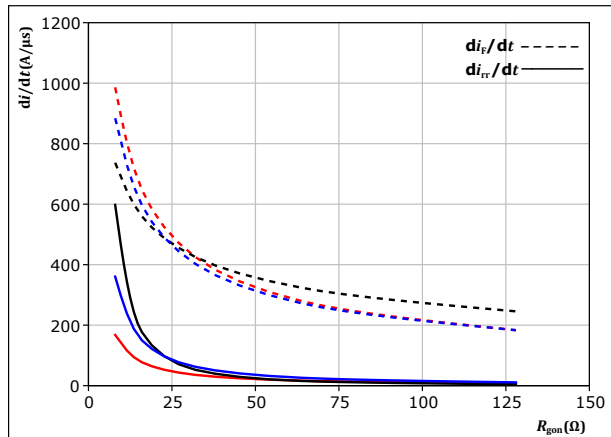

With an inductive load at

$V_{CE} = 400$ V	$T_j = 25$ °C
$V_{GE} = \pm 15$ V	$T_j = 125$ °C
$I_c = 15$ A	$T_j = 150$ °C

**figure 36.** IGBT

Reverse bias safe operating area  
 $I_c = f(V_{CE})$

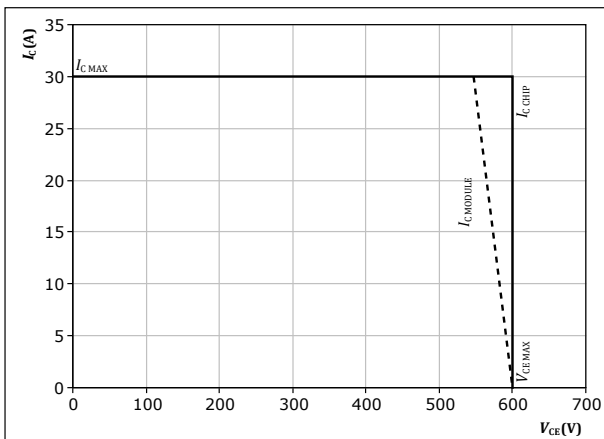

At  $T_j = 150$  °C  
 $R_{gon} = 32$  Ω  
 $R_{goff} = 32$  Ω



## PFC Switching Characteristics

**figure 37.** MOSFET

Typical switching energy losses as a function of drain current  
 $E = f(I_D)$

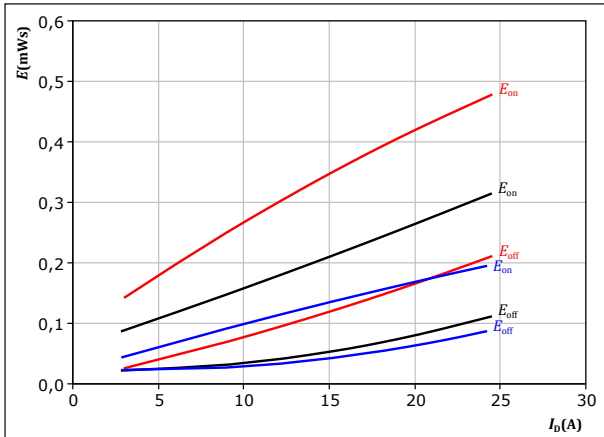

With an inductive load at

$V_{DS} = 400$  V  
 $V_{GS} = -5/10$  V  
 $R_{g\text{on}} = 8$   $\Omega$   
 $R_{g\text{off}} = 8$   $\Omega$

$T_j$ : — 25 °C  
 — 125 °C  
 — 150 °C

**figure 38.** MOSFET

Typical switching energy losses as a function of gate resistor  
 $E = f(R_g)$

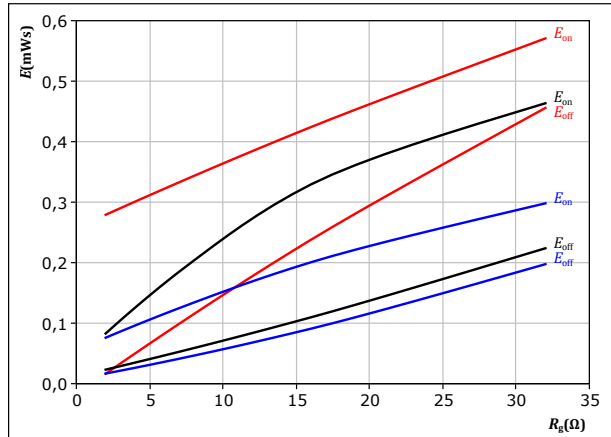

With an inductive load at

$V_{DS} = 400$  V  
 $V_{GS} = -5/10$  V  
 $I_D = 15$  A

$T_j$ : — 25 °C  
 — 125 °C  
 — 150 °C

**figure 39.** FWD

Typical reverse recovered energy loss as a function of drain current  
 $E_{rec} = f(I_D)$

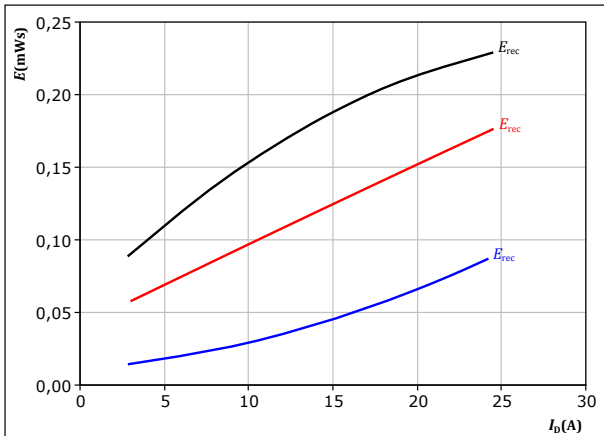

With an inductive load at

$V_{DS} = 400$  V  
 $V_{GS} = -5/10$  V  
 $R_{g\text{on}} = 8$   $\Omega$

$T_j$ : — 25 °C  
 — 125 °C  
 — 150 °C

**figure 40.** FWD

Typical reverse recovered energy loss as a function of gate resistor  
 $E_{rec} = f(R_g)$

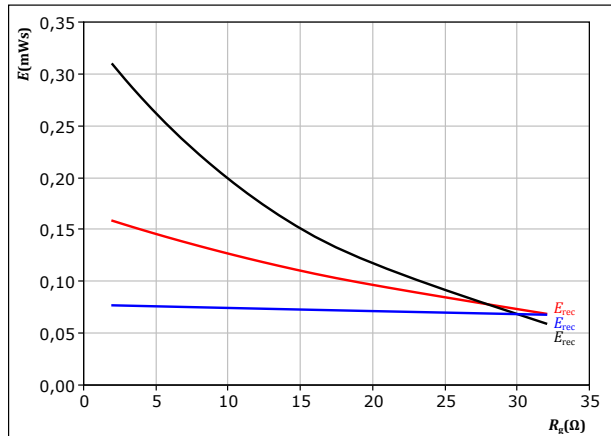

With an inductive load at

$V_{DS} = 400$  V  
 $V_{GS} = -5/10$  V  
 $I_D = 15$  A

$T_j$ : — 25 °C  
 — 125 °C  
 — 150 °C



## PFC Switching Characteristics

**figure 41.** MOSFET

Typical switching times as a function of drain current  
 $t = f(I_D)$

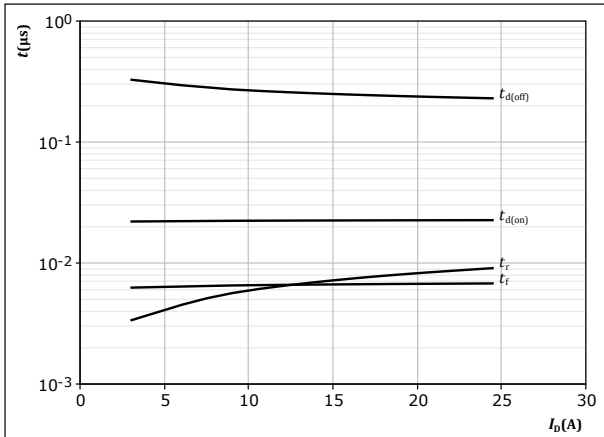

With an inductive load at  
 $T_j = 150 \text{ }^\circ\text{C}$   
 $V_{DS} = 400 \text{ V}$   
 $V_{GS} = -5/10 \text{ V}$   
 $R_{gon} = 8 \text{ } \Omega$   
 $R_{goff} = 8 \text{ } \Omega$

**figure 42.** MOSFET

Typical switching times as a function of gate resistor  
 $t = f(R_g)$

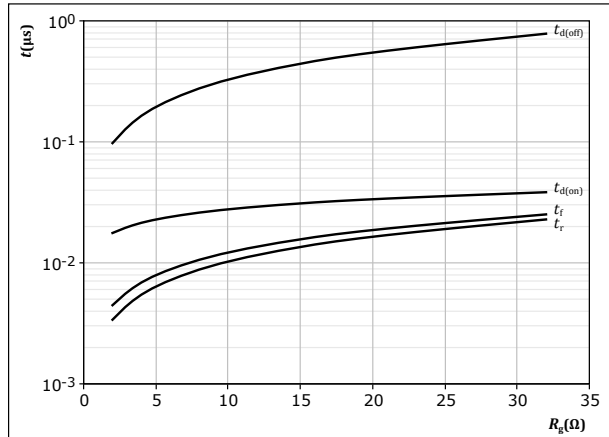

With an inductive load at  
 $T_j = 150 \text{ }^\circ\text{C}$   
 $V_{DS} = 400 \text{ V}$   
 $V_{GS} = -5/10 \text{ V}$   
 $I_D = 15 \text{ A}$

**figure 43.** FWD

Typical reverse recovery time as a function of drain current  
 $t_{rr} = f(I_D)$

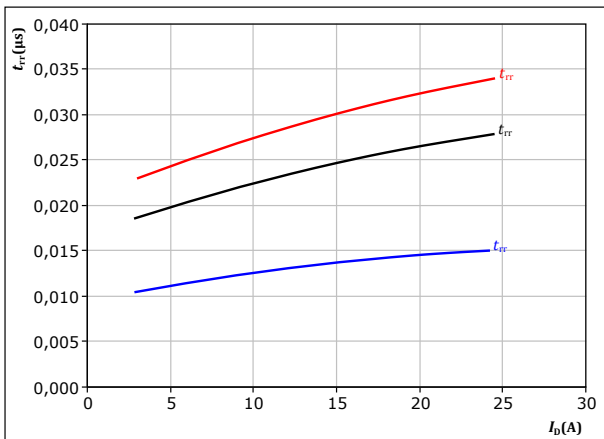

At  $V_{DS} = 400 \text{ V}$   
 $V_{GS} = -5/10 \text{ V}$   
 $R_{gon} = 8 \text{ } \Omega$   
 $T_j$ : 25 °C (blue), 125 °C (black), 150 °C (red)

**figure 44.** FWD

Typical reverse recovery time as a function of turn on gate resistor  
 $t_{rr} = f(R_{gon})$

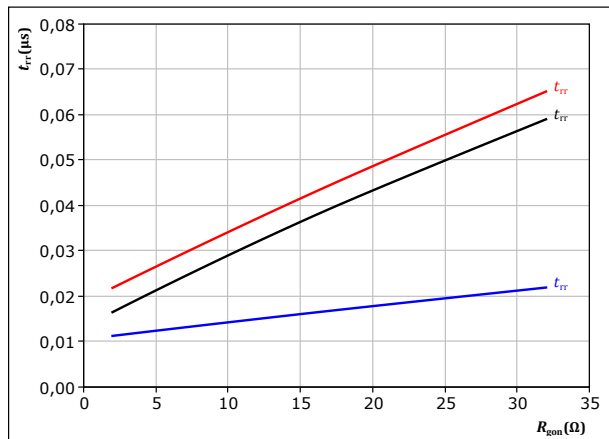

At  $V_{DS} = 400 \text{ V}$   
 $V_{GS} = -5/10 \text{ V}$   
 $I_D = 15 \text{ A}$   
 $T_j$ : 25 °C (blue), 125 °C (black), 150 °C (red)





## PFC Switching Characteristics

figure 45. FWD

Typical recovered charge as a function of drain current

$$Q_r = f(I_D)$$

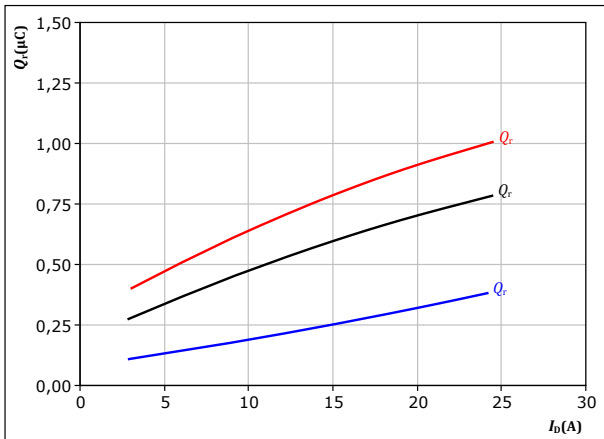

At  $V_{DS} = 400$  V  
 $V_{GS} = -5/10$  V  
 $R_{gon} = 8$  Ω  
 $T_j$ : 25 °C (blue), 125 °C (black), 150 °C (red)

figure 46. FWD

Typical recovered charge as a function of turn on gate resistor

$$Q_r = f(R_{gon})$$

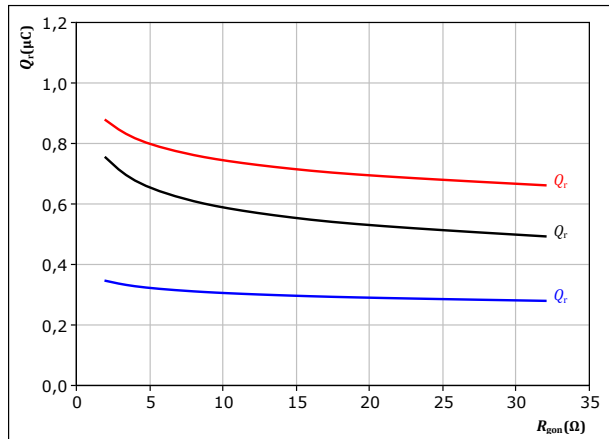

At  $V_{DS} = 400$  V  
 $V_{GS} = -5/10$  V  
 $I_D = 15$  A  
 $T_j$ : 25 °C (blue), 125 °C (black), 150 °C (red)

figure 47. FWD

Typical peak reverse recovery current as a function of drain current

$$I_{RM} = f(I_D)$$

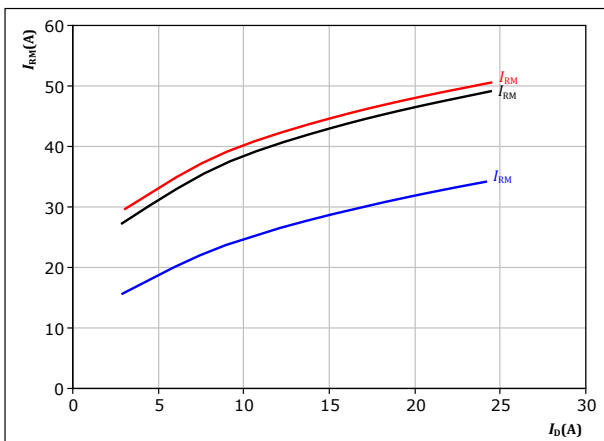

At  $V_{DS} = 400$  V  
 $V_{GS} = -5/10$  V  
 $R_{gon} = 8$  Ω  
 $T_j$ : 25 °C (blue), 125 °C (black), 150 °C (red)

figure 48. FWD

Typical peak reverse recovery current as a function of turn on gate resistor

$$I_{RM} = f(R_{gon})$$

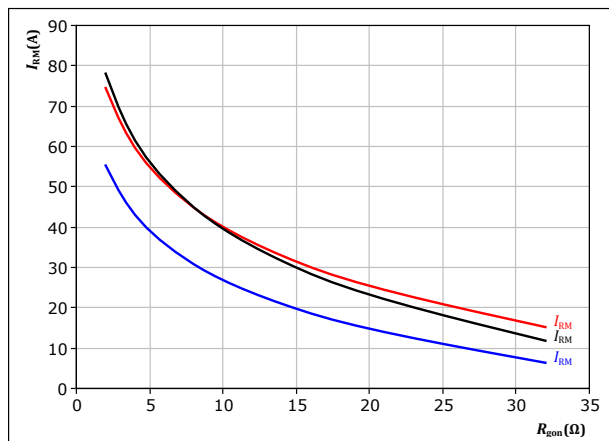

At  $V_{DS} = 400$  V  
 $V_{GS} = -5/10$  V  
 $I_D = 15$  A  
 $T_j$ : 25 °C (blue), 125 °C (black), 150 °C (red)



### PFC Switching Characteristics

**figure 49.** FWD

Typical rate of fall of forward and reverse recovery current as a function of drain current  
 $di_f/dt, di_r/dt = f(I_D)$

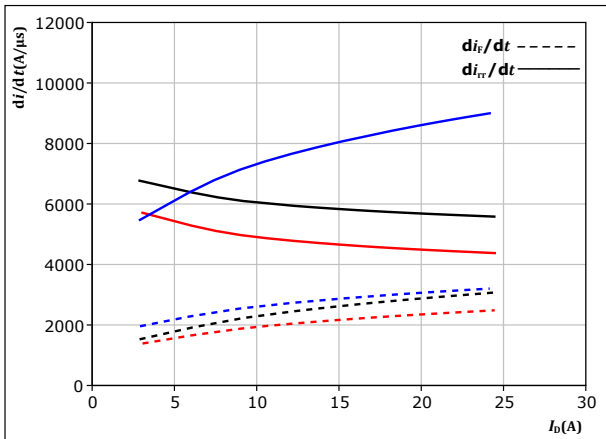

At  $V_{DS} = 400$  V  
 $V_{GS} = -5/10$  V  
 $R_{g(on)} = 8$   $\Omega$

$T_j$ : 25 °C  
 125 °C  
 150 °C

**figure 50.** FWD

Typical rate of fall of forward and reverse recovery current as a function of turn on gate resistor  
 $di_f/dt, di_r/dt = f(R_{g(on)})$

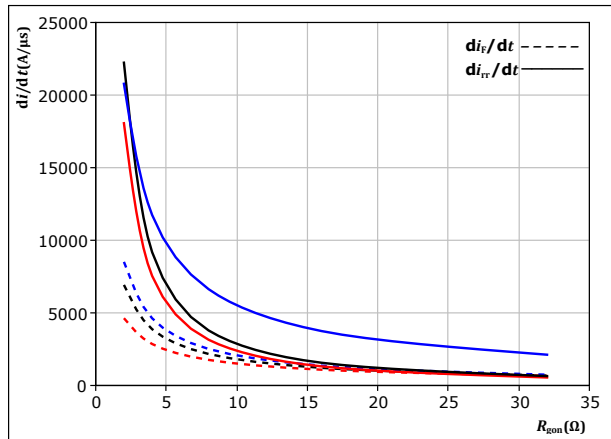

At  $V_{DS} = 400$  V  
 $V_{GS} = -5/10$  V  
 $I_D = 15$  A

$T_j$ : 25 °C  
 125 °C  
 150 °C

**figure 51.** MOSFET

Reverse bias safe operating area  
 $I_D = f(V_{DS})$

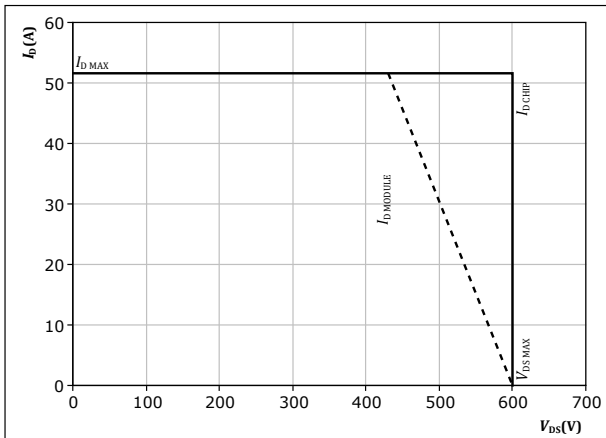

At  $T_j = 150$  °C  
 $R_{g(on)} = 8$   $\Omega$   
 $R_{g(off)} = 8$   $\Omega$



## Inverter Switching Definitions

**figure 52.** IGBT

Turn-off Switching Waveforms & definition of  $t_{doff}$ ,  $t_{Eoff}$  ( $t_{Eoff}$  = integrating time for  $E_{off}$ )

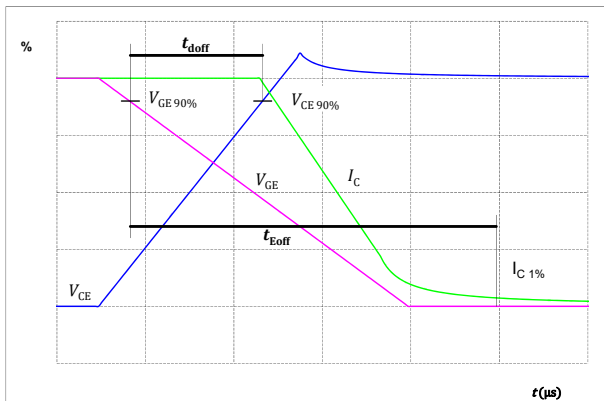

**figure 53.** IGBT

Turn-on Switching Waveforms & definition of  $t_{don}$ ,  $t_{Eon}$  ( $t_{Eon}$  = integrating time for  $E_{on}$ )

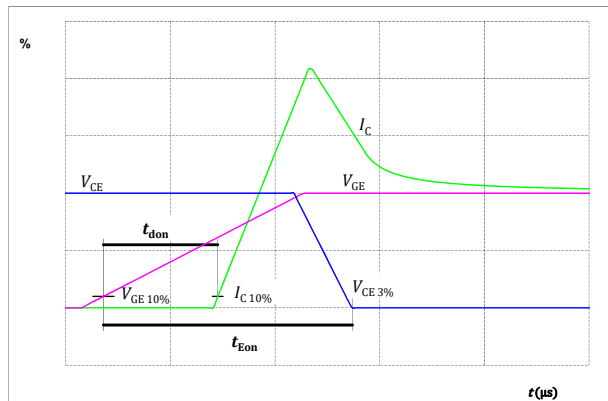

**figure 54.** IGBT

Turn-off Switching Waveforms & definition of  $t_f$

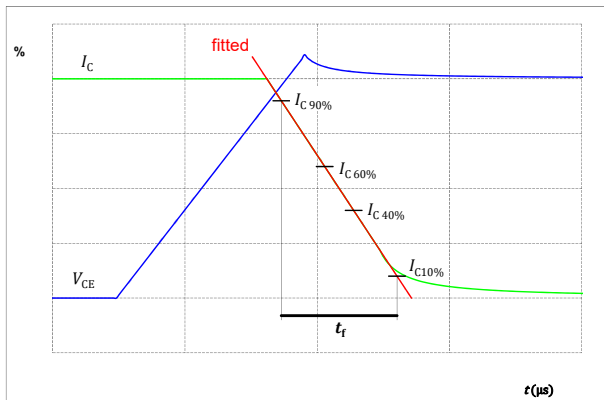

**figure 55.** IGBT

Turn-on Switching Waveforms & definition of  $t_r$

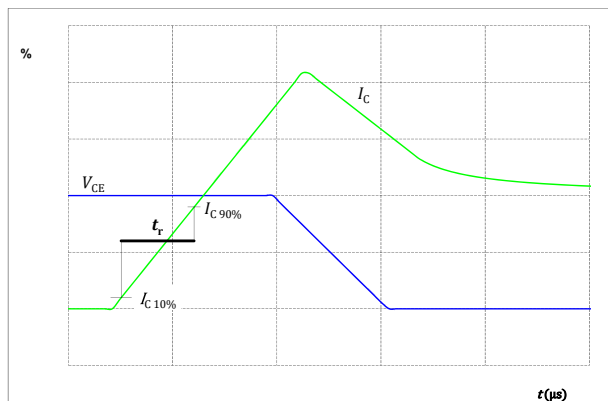



### Inverter Switching Definitions

figure 56. FWD

Turn-off Switching Waveforms & definition of  $t_{rr}$

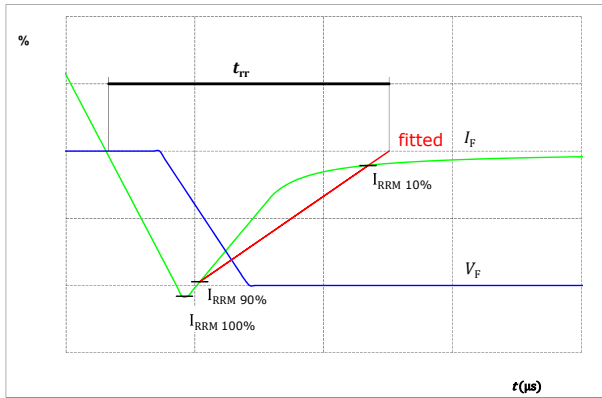
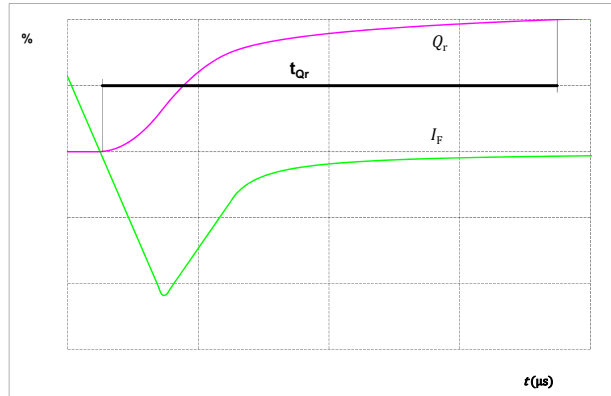

figure 57. FWD

Turn-on Switching Waveforms & definition of  $t_{Qr}$  ( $t_{Qr}$  = integrating time for  $Q_r$ )





### PFC Switching Definitions

figure 52. MOSFET

Turn-off Switching Waveforms & definition of  $t_{doff}$ ,  $t_{Eoff}$  ( $t_{Eoff}$  = integrating time for  $E_{off}$ )

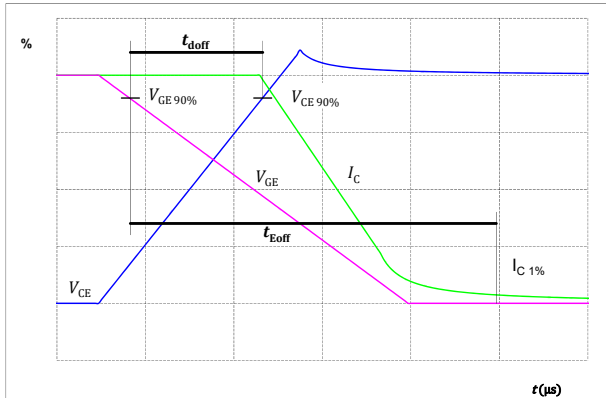

figure 53. MOSFET

Turn-on Switching Waveforms & definition of  $t_{don}$ ,  $t_{Eon}$  ( $t_{Eon}$  = integrating time for  $E_{on}$ )

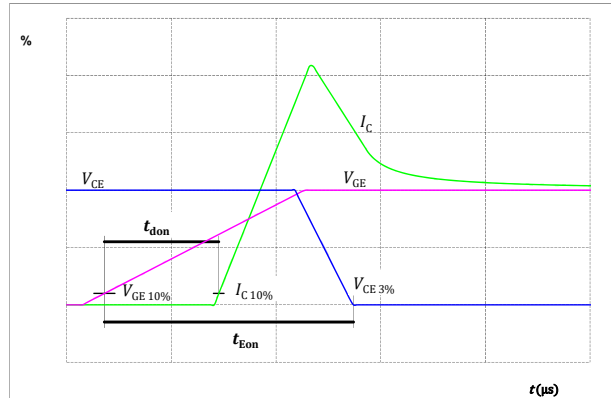

figure 54. MOSFET

Turn-off Switching Waveforms & definition of  $t_f$

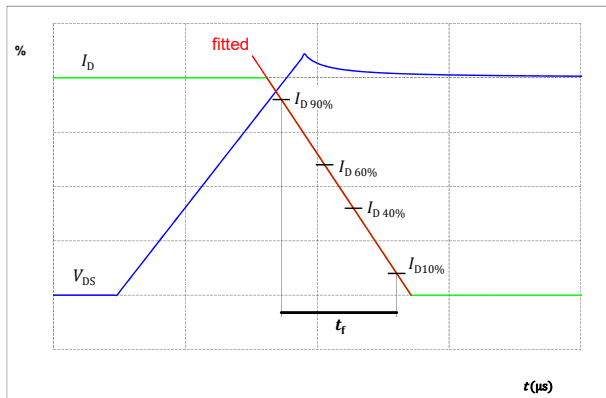
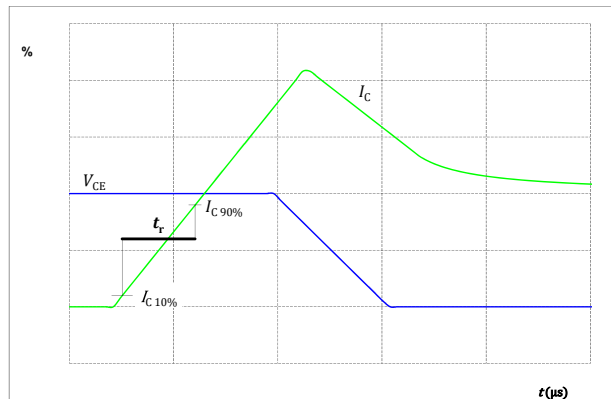

figure 55. MOSFET

Turn-on Switching Waveforms & definition of  $t_r$





### PFC Switching Definitions

figure 56. FWD

Turn-off Switching Waveforms & definition of  $t_{tr}$

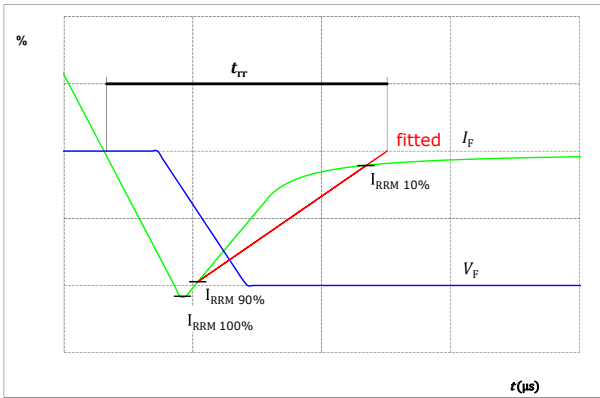

figure 57. FWD

Turn-on Switching Waveforms & definition of  $t_{Qr}$  ( $t_{Qr}$  = integrating time for  $Q_r$ )

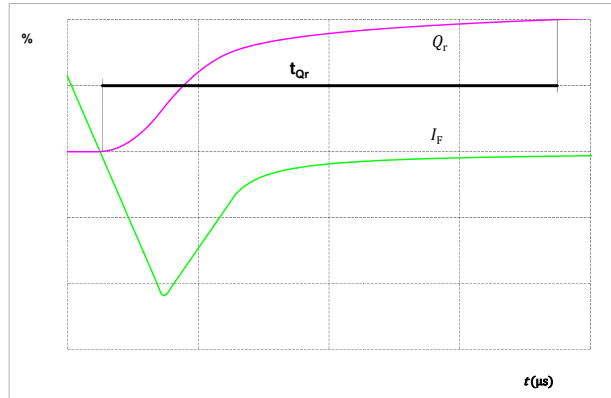
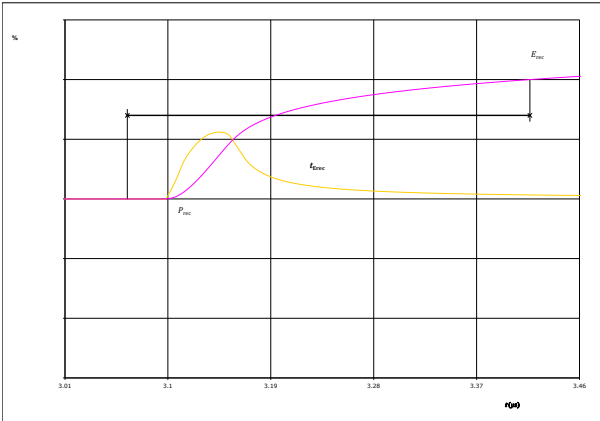

figure 58. FWD

Turn-on Switching Waveforms & definition of  $t_{Erec}$  ( $t_{Erec}$  = integrating time for  $E_{rec}$ )





Vincotech

**10-F006PPA015SB-M684B**  
datasheet

Ordering Code	
<b>Version</b>	<b>Ordering Code</b>
Without thermal paste	10-F006PPA015SB-M684B
With thermal paste	10-F006PPA015SB-M684B-/3/

Marking						
	<b>Text</b>	<b>Name</b> NN-NNNNNNNNNNNNNN- TTTTTVV	<b>Date code</b> WWYY	<b>UL &amp; VIN</b> UL VIN	<b>Lot</b> LLLLL	<b>Serial</b> SSSS
	<b>Datamatrix</b>	<b>Type&amp;Ver</b> TTTTTTTV	<b>Lot number</b> LLLLL	<b>Serial</b> SSSS	<b>Date code</b> WWYY	

Pin table [mm]			
Pin	X	Y	Function
1	33,5	0	DC-
2	30,7	0	PFC-
3	28	0	S1
4	25,3	0	S2
5	22,6	0	INV-
6	19,9	0	G7
7	17,2	0	S7
8	13,5	0	G6
9	10,8	0	E6
10	8,1	0	G5
11	5,4	0	E5
12	2,7	0	G4
13	0	0	E4
14	0	8,6	NTC1
15	0	11,45	NTC2
16	0	19,8	G1
17	0	22,5	U
18	6	19,8	G2
19	6	22,5	V
20	12	19,8	G3
21	12	22,5	W
22	17,7	22,5	+INV
23	20,5	22,5	PFC+
24	26,5	22,5	PFC IN
25	33,5	22,5	DC+
26	33,5	15	L1
27	33,5	7,5	L2

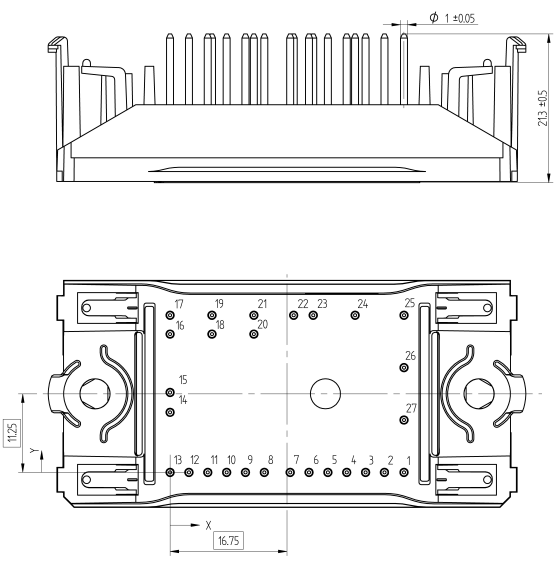

Tolerance of pinpositions: ±0.5mm at the end of pins  
Dimension of coordinate axis is only offset without tolerance



Vincotech

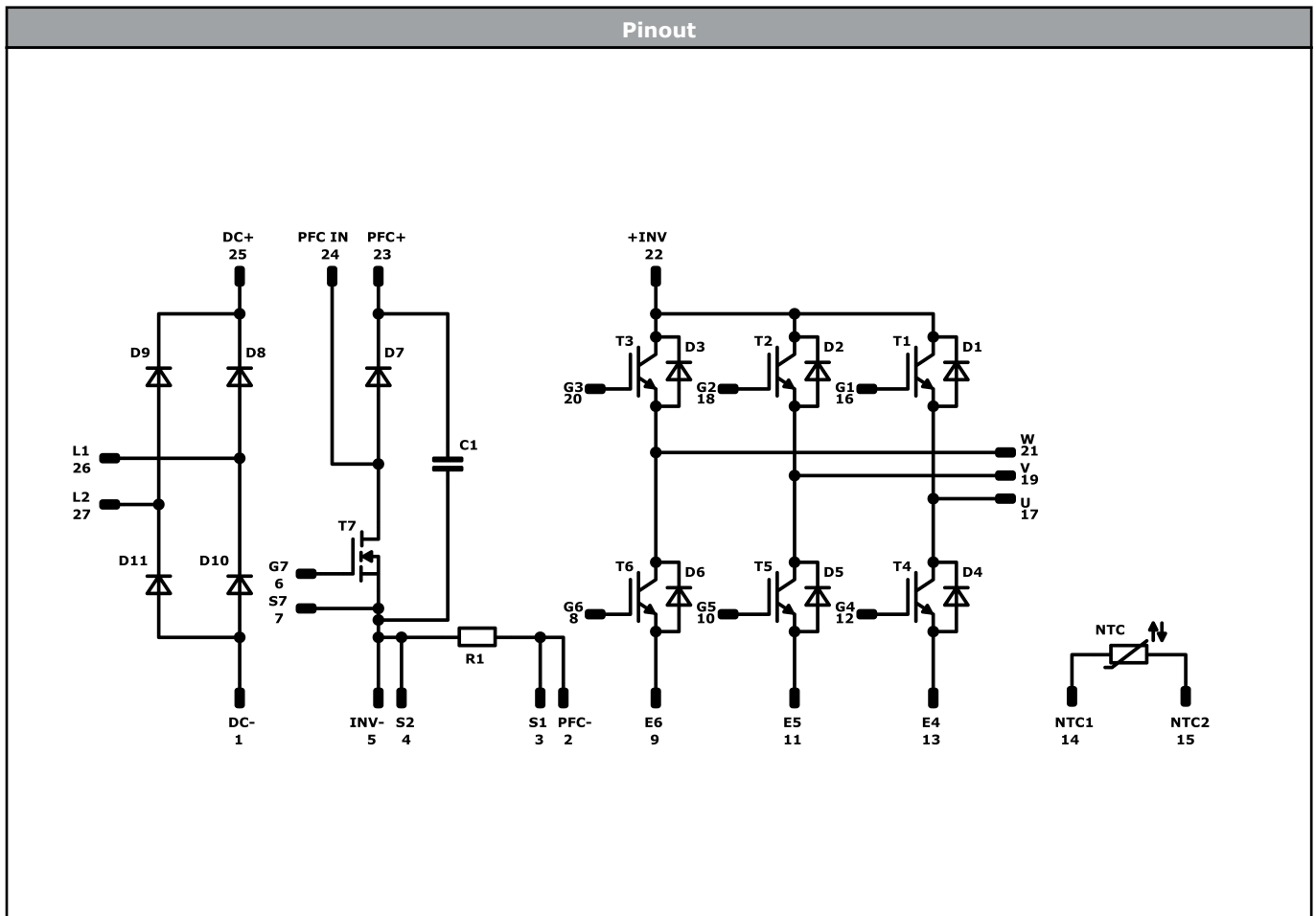

Identification					
ID	Component	Voltage	Current	Function	Comment
T6, T3, T5, T2, T4, T1	IGBT	600 V	15 A	Inverter Switch	
D3, D6, D2, D5, D1, D4	FWD	600 V	15 A	Inverter Diode	
T7	MOSFET	600 V	63 mΩ	PFC Switch	
D7	FWD	600 V	30 A	PFC Diode	
D11, D9, D10, D8	Rectifier	1600 V	25 A	Rectifier Diode	
R1	Shunt			PFC Shunt	
C1	Capacitor	500 V		Capacitor (PFC)	
NTC	Thermistor			Thermistor	





Packaging instruction				
Standard packaging quantity (SPQ) 135	>SPQ	Standard	<SPQ	Sample

Handling instruction
Handling instructions for <i>flow 0</i> packages see vincotech.com website.

Package data
Package data for <i>flow 0</i> packages see vincotech.com website.

UL recognition and file number
This device is certified according to UL 1557 standard, UL file number E192116. For more information see vincotech.com website. 

Document No.:	Date:	Modification:	Pages
10-F006PPA015SB-M684B-D4-14	30 Jun. 2020	Datasheet format update: Generalized format to Type-specific format Correct Rth of PFC Switch	

**DISCLAIMER**

The information, specifications, procedures, methods and recommendations herein (together "information") are presented by Vincotech to reader in good faith, are believed to be accurate and reliable, but may well be incomplete and/or not applicable to all conditions or situations that may exist or occur. Vincotech reserves the right to make any changes without further notice to any products to improve reliability, function or design. No representation, guarantee or warranty is made to reader as to the accuracy, reliability or completeness of said information or that the application or use of any of the same will avoid hazards, accidents, losses, damages or injury of any kind to persons or property or that the same will not infringe third parties rights or give desired results. It is reader's sole responsibility to test and determine the suitability of the information and the product for reader's intended use.

**LIFE SUPPORT POLICY**

Vincotech products are not authorised for use as critical components in life support devices or systems without the express written approval of Vincotech.

As used herein:

1. Life support devices or systems are devices or systems which, (a) are intended for surgical implant into the body, or (b) support or sustain life, or (c) whose failure to perform when properly used in accordance with instructions for use provided in labelling can be reasonably expected to result in significant injury to the user.
2. A critical component is any component of a life support device or system whose failure to perform can be reasonably expected to cause the failure of the life support device or system, or to affect its safety or effectiveness.