



<i>flowPIM E2</i>	1200 V / 35 A
<div style="border: 1px solid black; padding: 5px; margin-bottom: 10px;"> <p style="text-align: center; background-color: #ccc; margin: 0;">Features</p> <ul style="list-style-type: none"> Trench IGBT4 technology Standard industrial housing Optimized $R_{th(j-s)}$ with Phase Change Material Built-in NTC </div> <div style="border: 1px solid black; padding: 5px; margin-bottom: 10px;"> <p style="text-align: center; background-color: #ccc; margin: 0;">Target applications</p> <ul style="list-style-type: none"> Industrial Drives </div> <div style="border: 1px solid black; padding: 5px;"> <p style="text-align: center; background-color: #ccc; margin: 0;">Types</p> <ul style="list-style-type: none"> 10-E212PMA035SC-L188A48Z 10-EY12PMA035SC-L188A48T </div>	<div style="border: 1px solid black; padding: 5px; margin-bottom: 10px;"> <p style="text-align: center; background-color: #ccc; margin: 0;"><i>flow E2 12 mm housing</i></p> <div style="display: flex; justify-content: space-around; align-items: center;"> </div> <div style="display: flex; justify-content: space-around; margin-top: 5px;"> Solder pin Press-fit pin </div> </div> <div style="border: 1px solid black; padding: 5px;"> <p style="text-align: center; background-color: #ccc; margin: 0;">Schematic</p> </div>

Maximum Ratings

$T_j = 25\text{ °C}$, unless otherwise specified

Parameter	Symbol	Condition	Value	Unit
Inverter Switch				
Collector-emitter voltage	V_{CES}		1200	V
Collector current	I_C	$T_j = T_{jmax}$ $T_s = 80\text{ °C}$	43	A
Repetitive peak collector current	I_{CRM}	t_p limited by T_{jmax}	105	A
Total power dissipation	P_{tot}	$T_j = T_{jmax}$ $T_s = 80\text{ °C}$	116	W
Gate-emitter voltage	V_{GES}		±20	V
Short circuit ratings	t_{SC}	$T_j \leq 150\text{ °C}$ $V_{GE} = 15\text{ V}$ $V_{CC} = 800\text{ V}$	10	µs
Maximum junction temperature	T_{jmax}		175	°C



Maximum Ratings

$T_j = 25\text{ °C}$, unless otherwise specified

Parameter	Symbol	Condition	Value	Unit
Inverter Diode				
Peak repetitive reverse voltage	V_{RRM}		1200	V
Continuous (direct) forward current	I_F	$T_j = T_{jmax}$ $T_s = 80\text{ °C}$	43	A
Repetitive peak forward current	I_{FRM}		70	A
Total power dissipation	P_{tot}	$T_j = T_{jmax}$ $T_s = 80\text{ °C}$	80	W
Maximum junction temperature	T_{jmax}		175	°C
Brake Switch				
Collector-emitter voltage	V_{CES}		1200	V
Collector current	I_C	$T_j = T_{jmax}$ $T_s = 80\text{ °C}$	43	A
Repetitive peak collector current	I_{CRM}	t_p limited by T_{jmax}	105	A
Total power dissipation	P_{tot}	$T_j = T_{jmax}$ $T_s = 80\text{ °C}$	116	W
Gate-emitter voltage	V_{GES}		±20	V
Short circuit ratings	t_{SC}	$T_j \leq 150\text{ °C}$ $V_{GE} = 15\text{ V}$ $V_{CC} = 800\text{ V}$	10	µs
Maximum junction temperature	T_{jmax}		175	°C
Brake Diode				
Peak repetitive reverse voltage	V_{RRM}		1200	V
Continuous (direct) forward current	I_F	$T_j = T_{jmax}$ $T_s = 80\text{ °C}$	14	A
Repetitive peak forward current	I_{FRM}		20	A
Total power dissipation	P_{tot}	$T_j = T_{jmax}$ $T_s = 80\text{ °C}$	50	W
Maximum junction temperature	T_{jmax}		175	°C



Vincotech

10-E212PMA035SC-L188A48Z
10-EY12PMA035SC-L188A48T
 datasheet

Maximum Ratings

$T_j = 25\text{ °C}$, unless otherwise specified

Parameter	Symbol	Condition	Value	Unit
Rectifier Diode				
Peak repetitive reverse voltage	V_{RRM}		1600	V
Continuous (direct) forward current	I_F	$T_j = T_{jmax}$ $T_s = 80\text{ °C}$	51	A
Surge (non-repetitive) forward current	I_{FSM}	50 Hz Single Half Sine Wave $t_p = 10\text{ ms}$ $T_j = 150\text{ °C}$	350	A
Surge current capability	I^2t		610	A ² s
Total power dissipation	P_{tot}	$T_j = T_{jmax}$ $T_s = 80\text{ °C}$	60	W
Maximum junction temperature	T_{jmax}		150	°C

Module Properties

General Properties

Stray inductance	L_p		30	nH
------------------	-------	--	----	----

Thermal Properties

Storage temperature	T_{stg}		-40...+125	°C
Operation temperature under switching condition	T_{jop}		-40...(T _{jmax} - 25)	°C

Isolation Properties

Isolation voltage	V_{isol}	DC Test Voltage* $t_p = 2\text{ s}$	6000	V
		AC Voltage $t_p = 1\text{ min}$	2500	V
Creepage distance			min. 12,7	mm
Clearance		Solder pin / Press-fit pin	8,85 / 8,83	mm
Comparative Tracking Index	CTI		≥ 600	

*100 % tested in production



Characteristic Values

Parameter	Symbol	Conditions					Value			Unit
		V_{GS} [V]	V_{GE} [V]	V_{DS} [V]	I_D [A]	T_j [°C]	Min	Typ	Max	

Inverter Switch

Static

Parameter	Symbol	Conditions	V_{GS} [V]	V_{GE} [V]	V_{DS} [V]	I_D [A]	T_j [°C]	Min	Typ	Max	Unit
Gate-emitter threshold voltage	$V_{GE(th)}$	$V_{GE} = V_{CE}$				0,0012	25	5,3	5,8	6,3	V
Collector-emitter saturation voltage	$V_{CE(sat)}$		15			35	25 150	1,58	1,87 2,30	2,07	V
Collector-emitter cut-off current	I_{CES}		0	1200			25			5	µA
Gate-emitter leakage current	I_{GES}		20	0			25			120	nA
Internal gate resistance	r_g								none		Ω
Input capacitance	C_{ies}	$f = 1 \text{ Mhz}$	0	25			25		2000		pF
Reverse transfer capacitance	C_{res}								70		
Gate charge	Q_g		-15/15				25		270		nC

Thermal

Parameter	Symbol	Conditions	V_{GS} [V]	V_{GE} [V]	V_{DS} [V]	I_D [A]	T_j [°C]	Min	Typ	Max	Unit
Thermal resistance junction to sink	$R_{th(j-s)}$	$\lambda_{paste} = 3,4 \text{ W/mK}$ (PSX)							0,82		K/W

Dynamic

Parameter	Symbol	Conditions	V_{GS} [V]	V_{GE} [V]	V_{DS} [V]	I_D [A]	T_j [°C]	Min	Typ	Max	Unit
Turn-on delay time	$t_{d(on)}$	$R_{gon} = 16 \Omega$ $R_{goff} = 16 \Omega$	± 15		600	35		25	85		ns
Rise time	t_r							150	89		
Turn-off delay time	$t_{d(off)}$							25	22		
Fall time	t_f							150	26		
Turn-on energy (per pulse)*	E_{on}							25	199		
Turn-off energy (per pulse)*	E_{off}	150	259								
		25	73								
Turn-off energy (per pulse)*	E_{off}	150	115								
		25	2,48								
Turn-off energy (per pulse)*	E_{off}	150	3,71								
		25	1,84								
Turn-off energy (per pulse)*	E_{off}	150	2,91								
		25									

* $L_s = 10 \text{ nH}$



Vincotech

10-E212PMA035SC-L188A48Z
10-EY12PMA035SC-L188A48T
 datasheet

Characteristic Values

Parameter	Symbol	Conditions					Value			Unit
		V_{GE} [V]	V_{CE} [V]	I_C [A]	T_j [°C]	Min	Typ	Max		

Inverter Diode

Static

Parameter	Symbol	V_{GS} [V]	V_{DS} [V]	I_D [A]	T_j [°C]	Min	Typ	Max	Unit
Forward voltage	V_F			35	25 125 150		1,76 1,73 1,70	2,05	V
Reverse leakage current	I_R		1200		25			7,7	μA

Thermal

Parameter	Symbol	Conditions	Value	Unit
Thermal resistance junction to sink	$R_{th(j-s)}$	$\lambda_{paste} = 3,4$ W/mK (PSX)	1,19	K/W

Dynamic

Parameter	Symbol	dI/dt	V_{GS} [V]	V_{DS} [V]	I_C [A]	T_j [°C]	Min	Typ	Max	Unit	
Peak recovery current	I_{RRM}	± 15 600	±15	600	35	25 150		30 34		A	
Reverse recovery time	t_{rr}						25 150		298 493		ns
Recovered charge	Q_r						25 150		3,79 7,00		μC
Reverse recovered energy	E_{rec}						25 150		1,48 2,81		mWs
Peak rate of fall of recovery current	$(di_{rr}/dt)_{max}$						25 150		122 105		A/μs



Vincotech

10-E212PMA035SC-L188A48Z
10-EY12PMA035SC-L188A48T
 datasheet

Characteristic Values

Parameter	Symbol	Conditions					Value			Unit
		V_{GE} [V] V_{GS} [V]	V_{CE} [V] V_{DS} [V] V_F [V]	I_C [A] I_D [A] I_F [A]	T_j [°C]	Min	Typ	Max		

Brake Switch

Static

Gate-emitter threshold voltage	$V_{GE(th)}$	$V_{GE} = V_{CE}$			0,0012	25	5,3	5,8	6,3	V
Collector-emitter saturation voltage	$V_{CE(sat)}$		15		35	25 150	1,58	1,87 2,30	2,07	V
Collector-emitter cut-off current	I_{CES}		0	1200		25			5	µA
Gate-emitter leakage current	I_{GES}		20	0		25			120	nA
Internal gate resistance	r_g							none		Ω
Input capacitance	C_{ies}	$f = 1$ Mhz	0	25		25		2000		pF
Reverse transfer capacitance	C_{res}							70		
Gate charge	Q_g		-15/15			25		270		nC

Thermal

Thermal resistance junction to sink	$R_{th(j-s)}$	$\lambda_{paste} = 3,4$ W/mK (PSX)						0,82		K/W
-------------------------------------	---------------	---------------------------------------	--	--	--	--	--	------	--	-----

Dynamic

Turn-on delay time	$t_{d(on)}$	$R_{gon} = 32$ Ω $R_{goff} = 32$ Ω	±15	600	35	25		167		ns
						125		165		
						150		165		
Rise time	t_r					25		52		
						125		54		
						150		54		
Turn-off delay time	$t_{d(off)}$	25		252						
		125		313						
		150		334						
Fall time	t_f	25		60						
		125		124						
		150		141						
Turn-on energy (per pulse)	E_{on}	$Q_{tFWD} = 1,7$ µC				25		3,06		mWs
		$Q_{tFWD} = 3,1$ µC				125		3,73		
		$Q_{tFWD} = 3,6$ µC				150		3,86		
Turn-off energy (per pulse)	E_{off}					25		2,10		
						125		3,37		
						150		3,74		



Vincotech

10-E212PMA035SC-L188A48Z
10-EY12PMA035SC-L188A48T
 datasheet

Characteristic Values

Parameter	Symbol	Conditions					Value			Unit
		V_{GE} [V]	V_{CE} [V]	I_C [A]	T_j [°C]	Min	Typ	Max		

Brake Diode

Static

Parameter	Symbol	V_{GE} [V]	V_{CE} [V]	I_C [A]	T_j [°C]	Min	Typ	Max	Unit
Forward voltage	V_F			10	25 150		1,77 1,68	2,05	V
Reverse leakage current	I_R		1200		25			2,7	μA

Thermal

Parameter	Symbol	Conditions	Value	Unit
Thermal resistance junction to sink	$R_{th(j-s)}$	$\lambda_{paste} = 3,4$ W/mK (PSX)	1,91	K/W

Dynamic

Parameter	Symbol	V_{GE} [V]	V_{CE} [V]	I_C [A]	T_j [°C]	Min	Typ	Max	Unit
Peak recovery current	I_{RRM}				25 125 150		10 12 13		A
Reverse recovery time	t_{rr}				25 125 150		394 574 653		ns
Recovered charge	Q_r			±15	600	35	25 125 150	1,74 3,09 3,55	μC
Reverse recovered energy	E_{rec}						25 125 150	0,669 1,26 1,47	mWs
Peak rate of fall of recovery current	$(di_{rr}/dt)_{max}$						25 125 150	41 21 21	A/μs

Rectifier Diode

Static

Parameter	Symbol	V_{GE} [V]	V_{CE} [V]	I_C [A]	T_j [°C]	Min	Typ	Max	Unit
Forward voltage	V_F			45	25 125		1,15 1,12		V
Reverse leakage current	I_R		1600		25			50	μA

Thermal

Parameter	Symbol	Conditions	Value	Unit
Thermal resistance junction to sink	$R_{th(j-s)}$	$\lambda_{paste} = 3,4$ W/mK (PSX)	1,17	K/W



Vincotech

10-E212PMA035SC-L188A48Z
10-EY12PMA035SC-L188A48T
 datasheet

Characteristic Values

Parameter	Symbol	Conditions					Value			Unit
		V_{GS} [V]	V_{GE} [V]	V_{DS} [V]	I_D [A]	I_C [A]	T_j [°C]	Min	Typ	

Thermistor

Rated resistance	R					25		5		k Ω
Deviation of R_{100}	$\Delta_{R/R}$	$R_{100} = 493 \Omega$				100	-5		+5	%
Power dissipation	P					25		245		mW
Power dissipation constant						25		1,4		mW/K
B-value	$B_{(25/50)}$	Tol. $\pm 2 \%$				25		3375		K
B-value	$B_{(25/100)}$	Tol. $\pm 2 \%$				25		3437		K
Vincotech NTC Reference									K	



Inverter Switch Characteristics

figure 1. IGBT

Typical output characteristics

$I_C = f(V_{CE})$

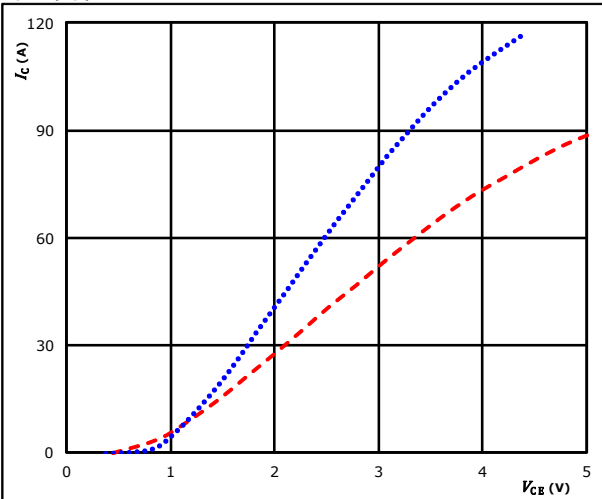

$t_p = 250 \mu s$
 $V_{GE} = 15 V$
 $T_j: 25 \text{ } ^\circ C$ (blue dotted line)
 $150 \text{ } ^\circ C$ (red dashed line)

figure 2. IGBT

Typical output characteristics

$I_C = f(V_{CE})$

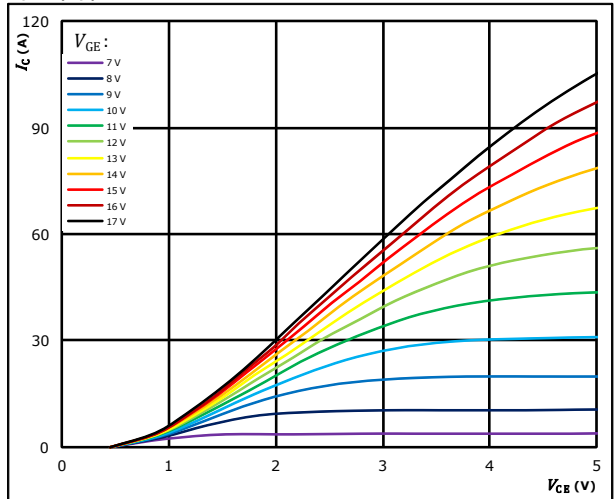

$t_p = 250 \mu s$
 $T_j = 150 \text{ } ^\circ C$
 V_{GE} from 7 V to 17 V in steps of 1 V

figure 3. IGBT

Typical transfer characteristics

$I_C = f(V_{GE})$

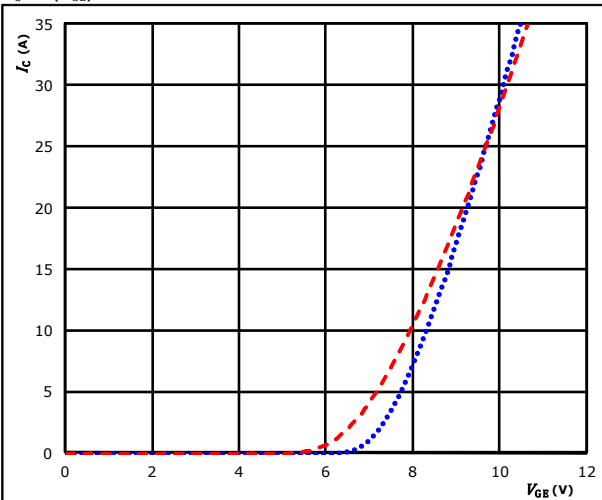

$t_p = 100 \mu s$
 $V_{CE} = 10 V$
 $T_j: 25 \text{ } ^\circ C$ (blue dotted line)
 $150 \text{ } ^\circ C$ (red dashed line)

figure 4. IGBT

Transient thermal impedance as function of pulse duration

$Z_{th(j-s)} = f(t_p)$

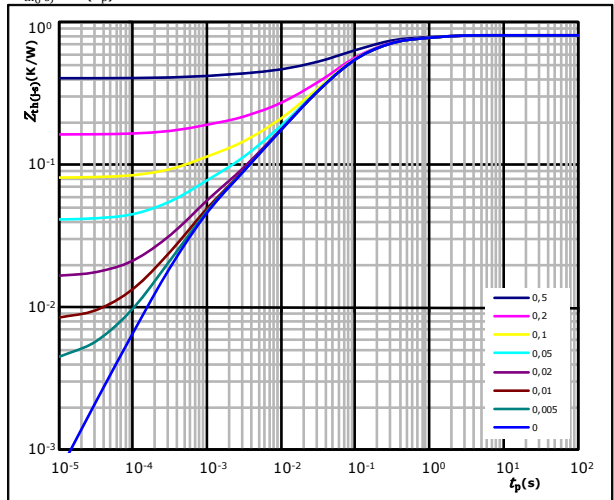

$D = t_p / T$
 $R_{th(j-s)} = 0,82 \text{ K/W}$

IGBT thermal model values

R (K/W)	τ (s)
1,04E-01	8,11E-01
3,36E-01	1,17E-01
2,58E-01	4,29E-02
8,09E-02	7,80E-03
3,79E-02	7,37E-04



Inverter Switch Characteristics

figure 5. IGBT

Safe operating area

$$I_C = f(V_{CE})$$

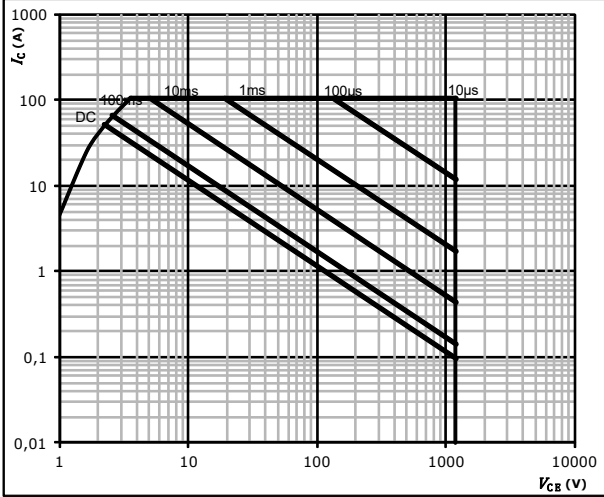

- $D =$ single pulse
- $T_s =$ 80 °C
- $V_{GE} =$ ± 15 V
- $T_j =$ T_{max}



Inverter Diode Characteristics

figure 1. **FWD**

Typical forward characteristics

$$I_F = f(V_F)$$

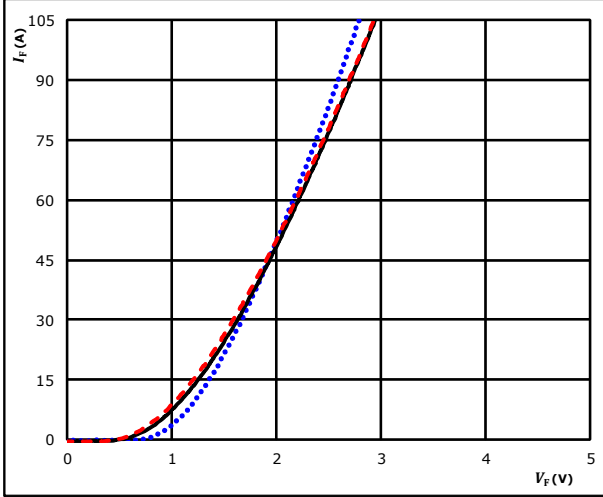

$t_p = 250 \mu s$ T_j :

25 °C
 125 °C ———
 150 °C - - -

figure 2. **FWD**

Transient thermal impedance as a function of pulse width

$$Z_{th(j-s)} = f(t_p)$$

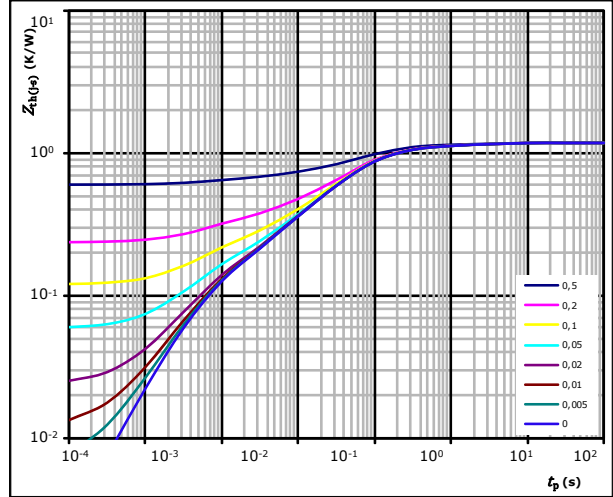

$D = t_p / T$
 $R_{th(j-s)} = 1,19 \text{ K/W}$

FWD thermal model values

R (K/W)	τ (s)
6,30E-02	2,93E+00
1,30E-01	4,06E-01
5,50E-01	7,36E-02
2,26E-01	2,16E-02
1,15E-01	4,46E-03
9,49E-02	5,82E-04
8,50E-03	2,11E-04



Brake Switch Characteristics

figure 1. IGBT

Typical output characteristics

$$I_C = f(V_{CE})$$

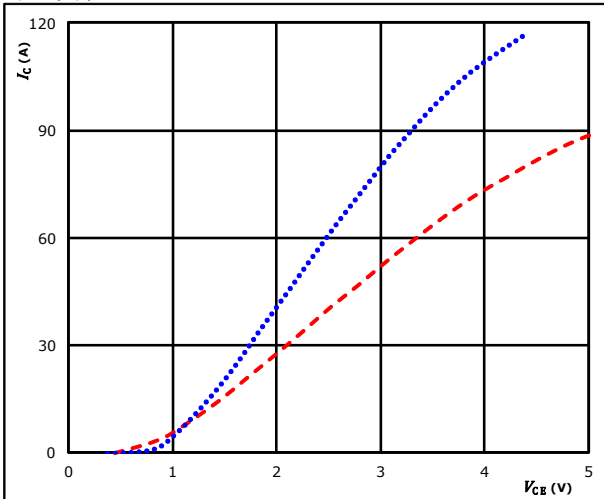

$t_p = 250 \mu\text{s}$
 $V_{GE} = 15 \text{ V}$
 $T_j: 25 \text{ }^\circ\text{C}$ (blue dotted line)
 $150 \text{ }^\circ\text{C}$ (red dashed line)

figure 2. IGBT

Typical output characteristics

$$I_C = f(V_{CE})$$

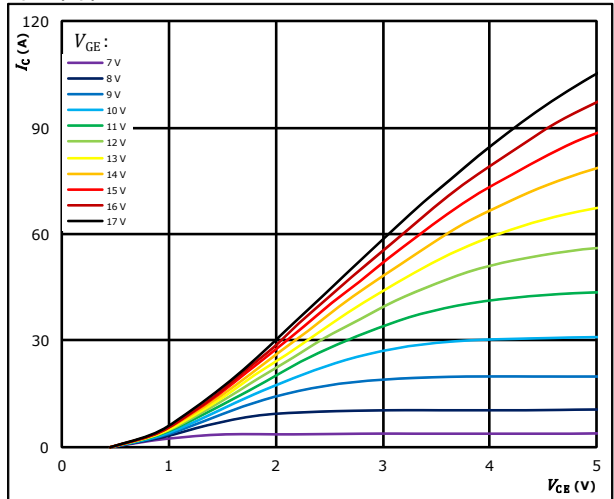

$t_p = 250 \mu\text{s}$
 $T_j = 150 \text{ }^\circ\text{C}$
 V_{GE} from 7 V to 17 V in steps of 1 V

figure 3. IGBT

Typical transfer characteristics

$$I_C = f(V_{GE})$$

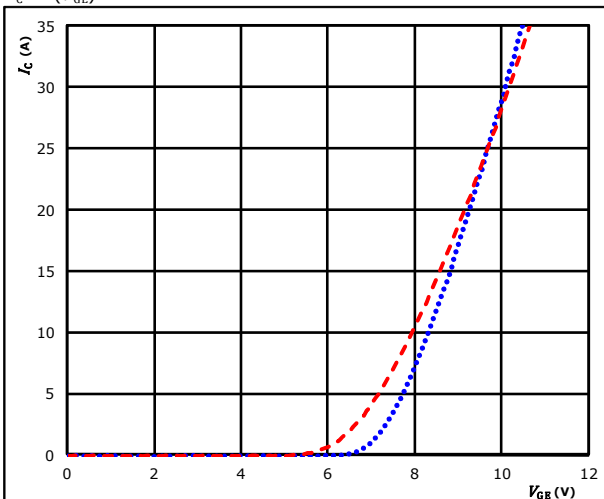

$t_p = 100 \mu\text{s}$
 $V_{CE} = 10 \text{ V}$
 $T_j: 25 \text{ }^\circ\text{C}$ (blue dotted line)
 $150 \text{ }^\circ\text{C}$ (red dashed line)

figure 4. IGBT

Transient thermal impedance as function of pulse duration

$$Z_{th(j-s)} = f(t_p)$$

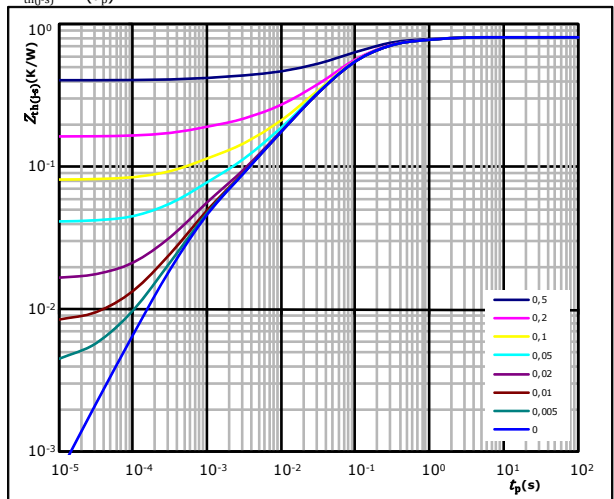

$D = t_p / T$
 $R_{th(j-s)} = 0,82 \text{ K/W}$

IGBT thermal model values

R (K/W)	τ (s)
1,04E-01	8,11E-01
3,36E-01	1,17E-01
2,58E-01	4,29E-02
8,09E-02	7,80E-03
3,79E-02	7,37E-04



Brake Switch Characteristics

figure 5. IGBT

Safe operating area

$$I_C = f(V_{CE})$$

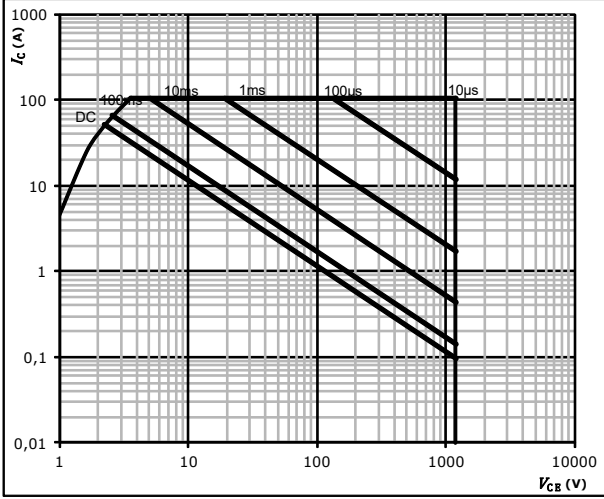

- $D =$ single pulse
- $T_s =$ 80 °C
- $V_{GE} =$ ±15 V
- $T_j =$ T_{max}



Brake Diode Characteristics

figure 1. FWD

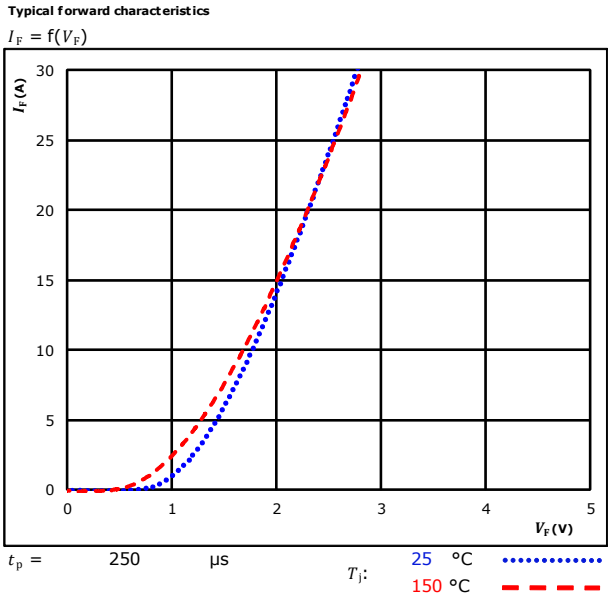
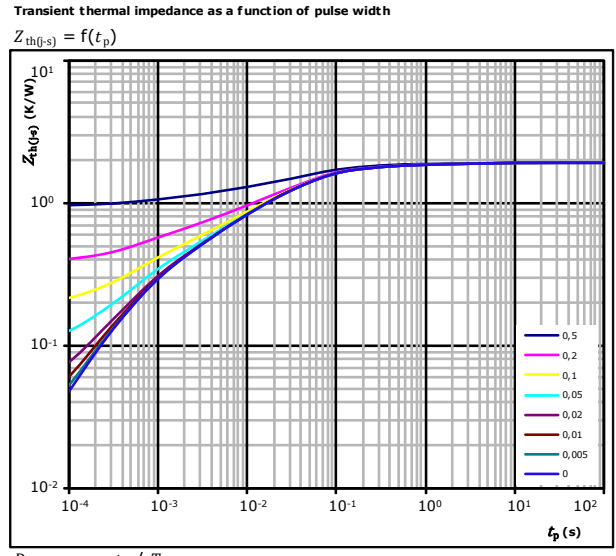

figure 2. FWD



FWD thermal model values

R (K/W)	τ (s)
6,90E-02	3,61E+00
1,74E-01	3,07E-01
8,07E-01	4,87E-02
3,70E-01	1,36E-02
2,79E-01	3,22E-03
2,10E-01	5,68E-04



Rectifier Diode Characteristics

figure 1. Rectifier Diode

Typical forward characteristics

$$I_F = f(V_F)$$

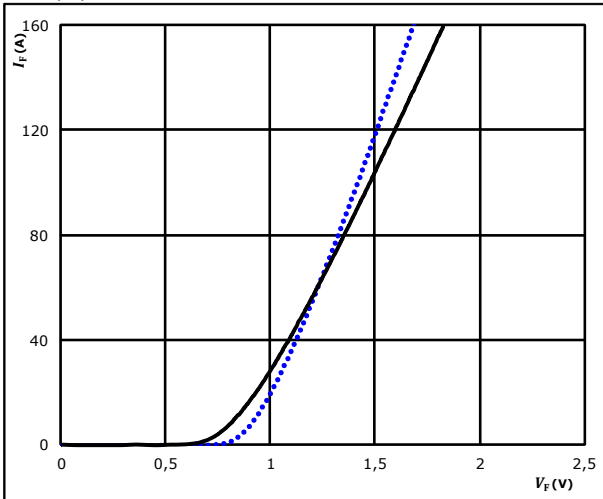

$t_p = 250 \mu s$ $T_j: 25 \text{ }^\circ\text{C}$ (dotted blue line) $125 \text{ }^\circ\text{C}$ (solid black line)

figure 2. Rectifier Diode

Transient thermal impedance as a function of pulse width

$$Z_{th(j-s)} = f(t_p)$$

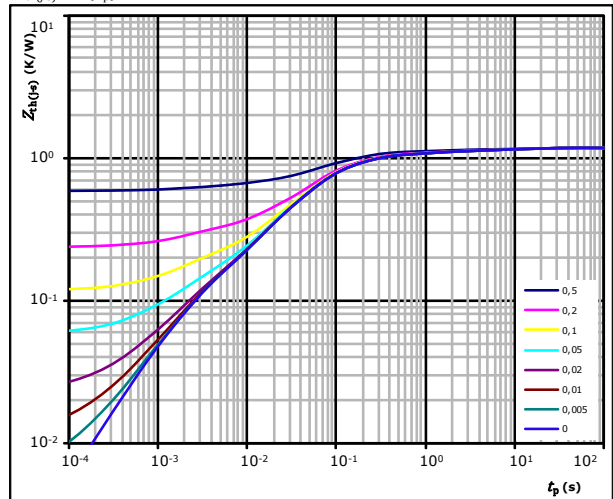

$D = t_p / T$
 $R_{th(j-s)} = 1,17 \text{ K/W}$
 Diode thermal model values

$R \text{ (K/W)}$	$\tau \text{ (s)}$
7,71E-02	9,00E+00
1,19E-01	7,09E-01
4,99E-01	1,03E-01
3,97E-01	3,61E-02
8,19E-02	2,07E-03

Thermistor Characteristics

figure 1. Thermistor

Typical NTC characteristic
 as a function of temperature

$$R = f(T)$$

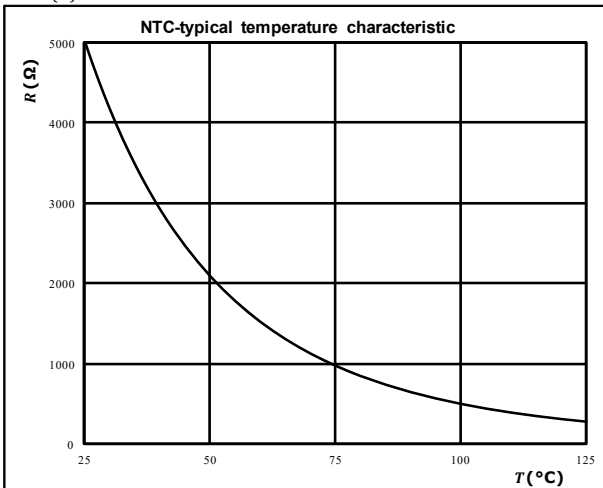



Inverter Switching Characteristics

figure 1. IGBT

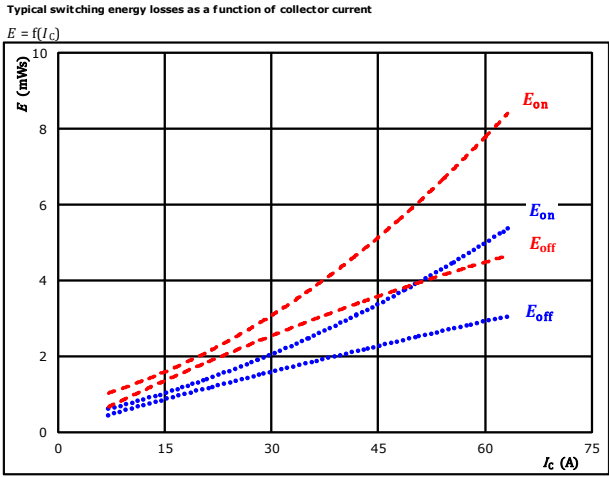

With an inductive load at
 $V_{CE} = 600$ V
 $V_{GE} = \pm 15$ V
 $R_{g\text{on}} = 16$ Ω
 $R_{g\text{off}} = 16$ Ω

T_j : 25 °C (blue dotted line)
 150 °C (red dashed line)

figure 2. IGBT

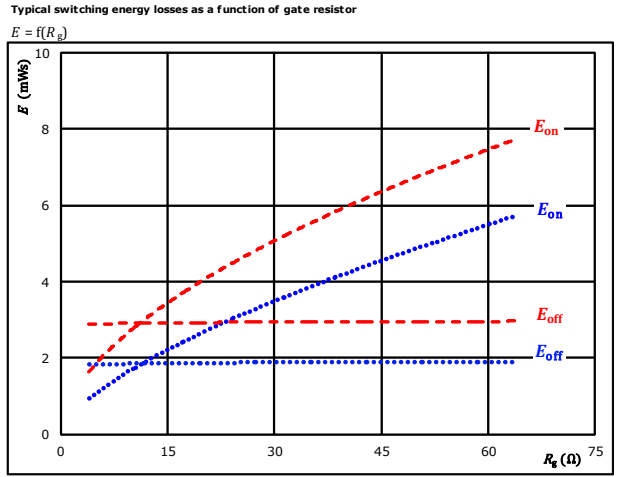

With an inductive load at
 $V_{CE} = 600$ V
 $V_{GE} = \pm 15$ V
 $I_C = 35$ A

T_j : 25 °C (blue dotted line)
 150 °C (red dashed line)

figure 3. FWD

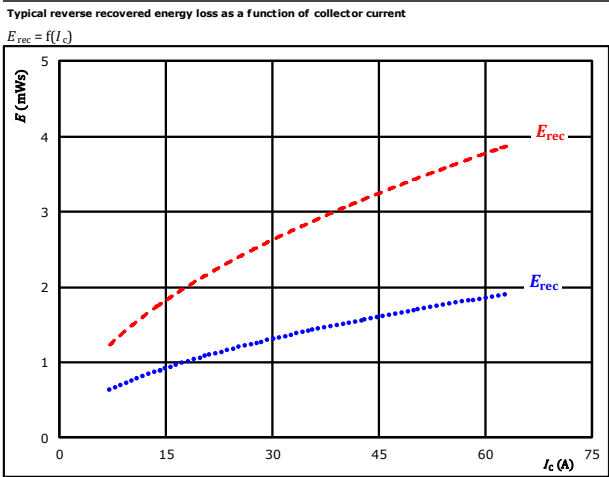

With an inductive load at
 $V_{CE} = 600$ V
 $V_{GE} = \pm 15$ V
 $R_{g\text{on}} = 16$ Ω

T_j : 25 °C (blue dotted line)
 150 °C (red dashed line)

figure 4. FWD

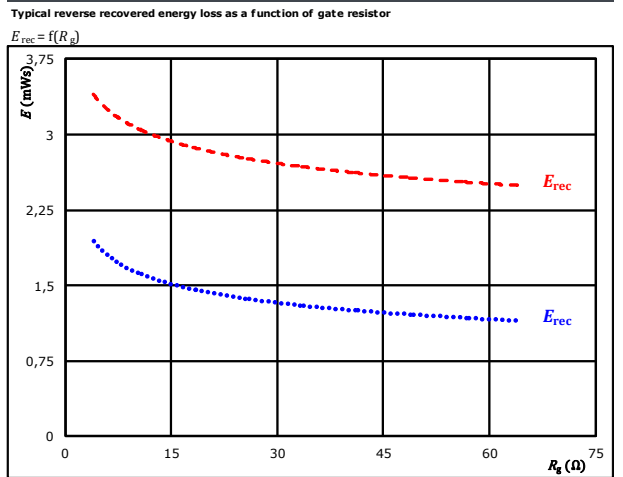

With an inductive load at
 $V_{CE} = 600$ V
 $V_{GE} = \pm 15$ V
 $I_C = 35$ A

T_j : 25 °C (blue dotted line)
 150 °C (red dashed line)



Inverter Switching Characteristics

figure 5. IGBT

Typical switching times as a function of collector current

$$t = f(I_C)$$

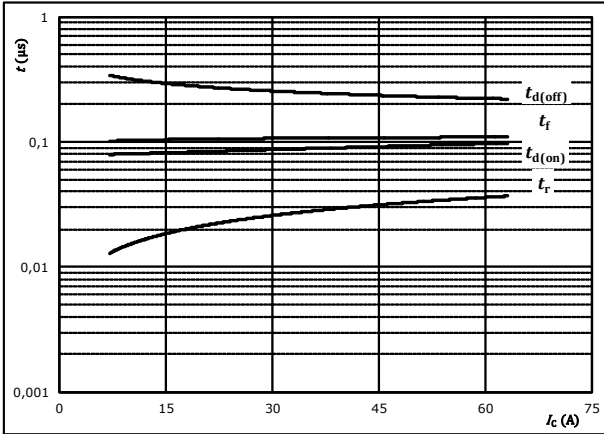

With an inductive load at

$T_j =$	150	°C
$V_{CE} =$	600	V
$V_{GE} =$	±15	V
$R_{g(on)} =$	16	Ω
$R_{g(off)} =$	16	Ω

figure 6. IGBT

Typical switching times as a function of gate resistor

$$t = f(R_g)$$

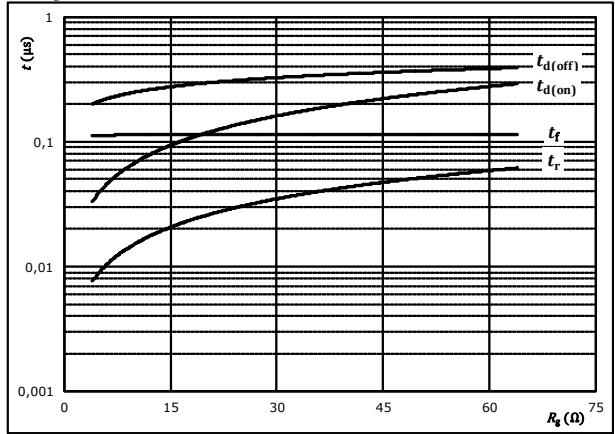

With an inductive load at

$T_j =$	150	°C
$V_{CE} =$	600	V
$V_{GE} =$	±15	V
$I_C =$	35	A

figure 7. FWD

Typical reverse recovery time as a function of collector current

$$t_{rr} = f(I_C)$$

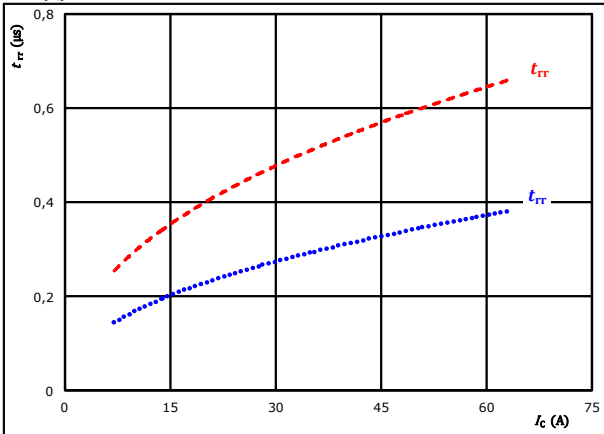

At	$V_{CE} =$	600	V	$T_j =$	25 °C
	$V_{GE} =$	±15	V		150 °C	-----
	$R_{g(on)} =$	16	Ω			

figure 8. FWD

Typical reverse recovery time as a function of IGBT turn on gate resistor

$$t_{rr} = f(R_{g(on)})$$

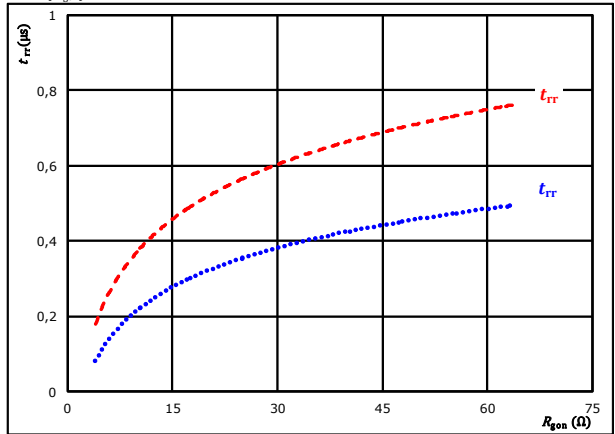

At	$V_{CE} =$	600	V	$T_j =$	25 °C
	$V_{GE} =$	±15	V		150 °C	-----
	$I_C =$	35	A			



Inverter Switching Characteristics

figure 9. FWD

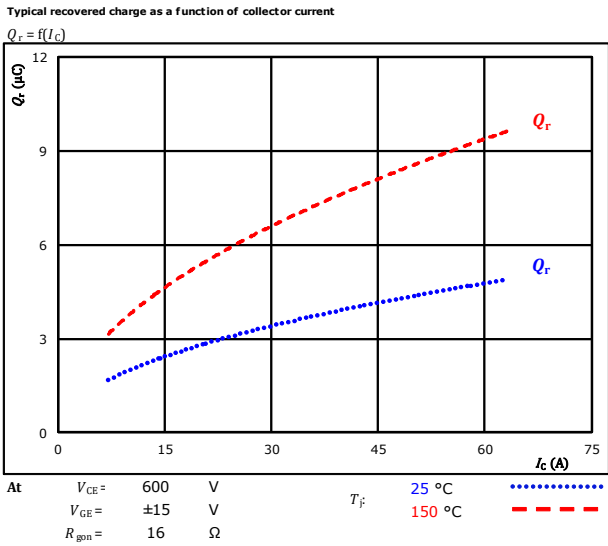

figure 10. FWD

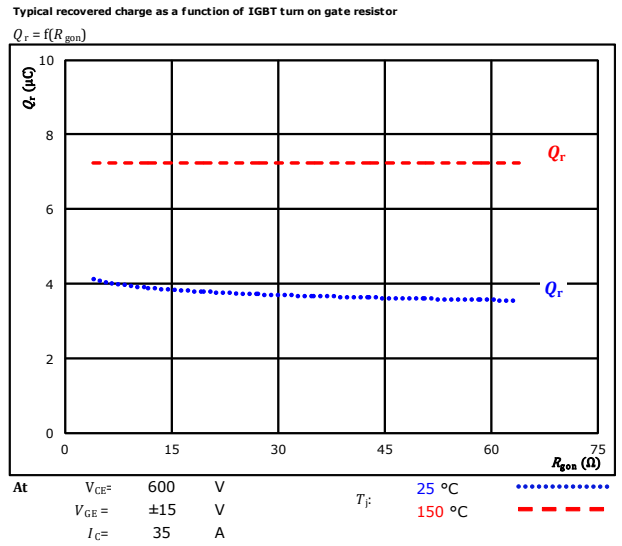

figure 11. FWD

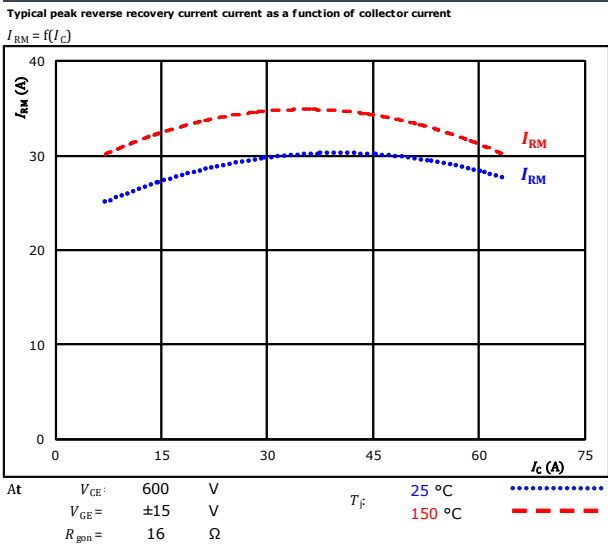
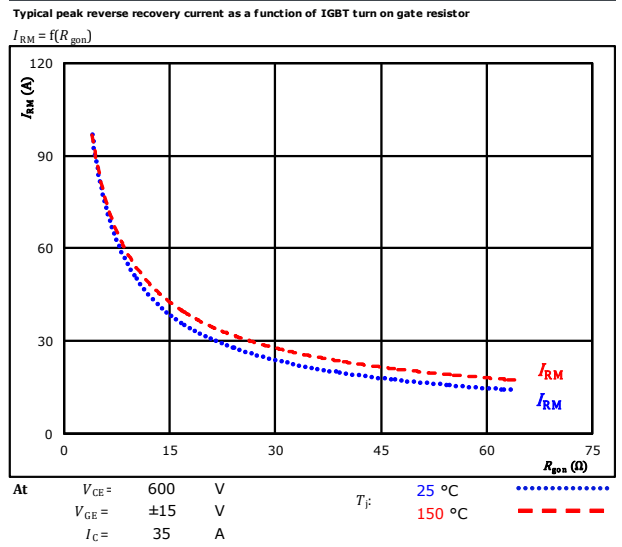

figure 12. FWD





Inverter Switching Characteristics

figure 13. FWD

Typical rate of fall of forward and reverse recovery current as a function of collector current
 $di_f/dt, di_{rr}/dt = f(I_c)$

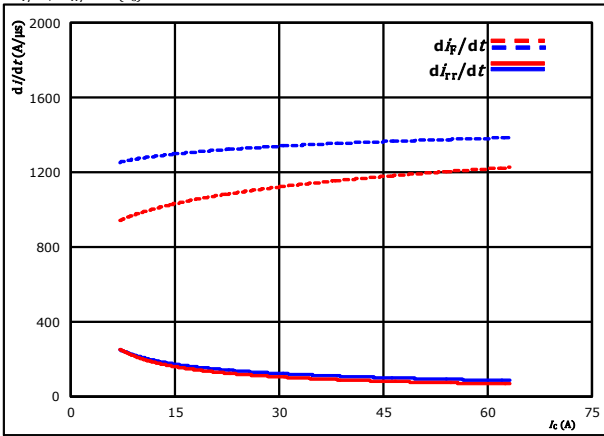

At $V_{CE} = 600$ V $T_j = 25$ °C
 $V_{GE} = \pm 15$ V $T_j = 150$ °C
 $R_{gon} = 16$ Ω

figure 14. FWD

Typical rate of fall of forward and reverse recovery current as a function of IGBT turn on gate resistor
 $di_f/dt, di_{rr}/dt = f(R_{gon})$

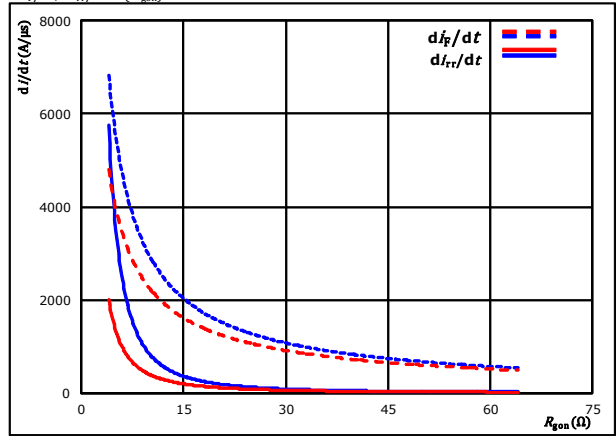

At $V_{CE} = 600$ V $T_j = 25$ °C
 $V_{GE} = \pm 15$ V $T_j = 150$ °C
 $I_c = 35$ A

figure 15. IGBT

Reverse bias safe operating area
 $I_c = f(V_{CB})$

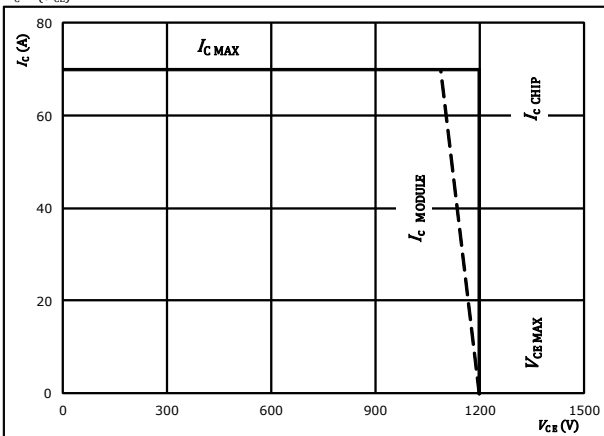

At $T_j = 175$ °C
 $R_{gon} = 16$ Ω
 $R_{goff} = 16$ Ω



Inverter Switching Definitions

General conditions		
T_j	=	125 °C
R_{gon}	=	16 Ω
R_{goff}	=	16 Ω

figure 1. IGBT

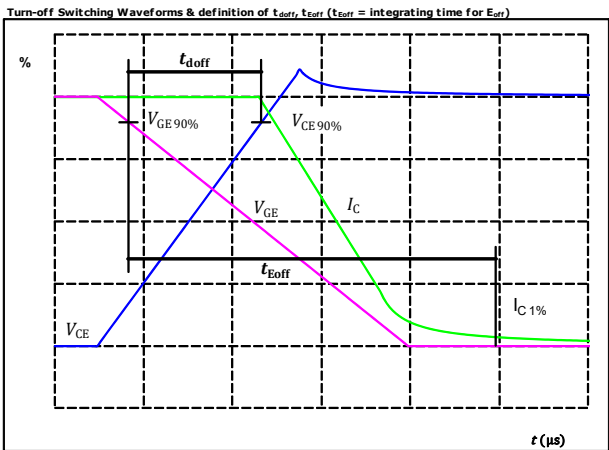

$V_{CE}(0\%) =$	-15	V
$V_{GE}(100\%) =$	15	V
$V_C(100\%) =$	600	V
$I_C(100\%) =$	35	A
$t_{doff} =$	259	ns

figure 2. IGBT

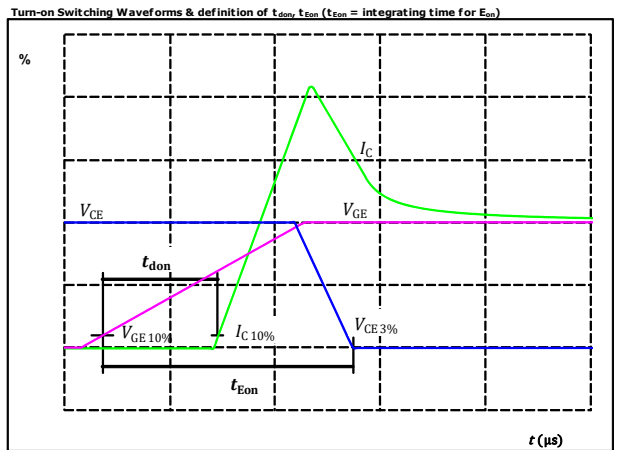

$V_{CE}(0\%) =$	-15	V
$V_{GE}(100\%) =$	15	V
$V_C(100\%) =$	600	V
$I_C(100\%) =$	35	A
$t_{don} =$	89	ns

figure 3. IGBT

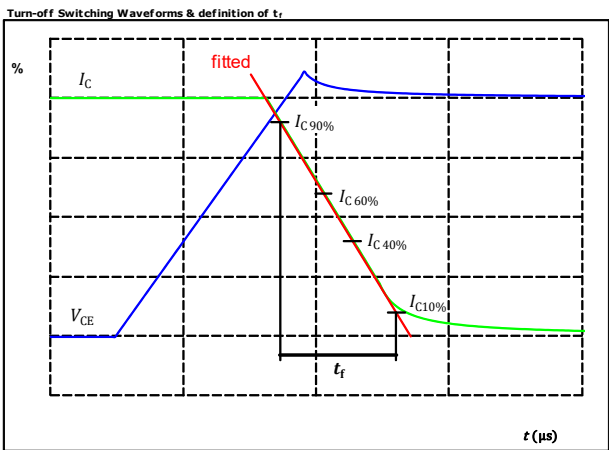

$V_C(100\%) =$	600	V
$I_C(100\%) =$	35	A
$t_f =$	115	ns

figure 4. IGBT

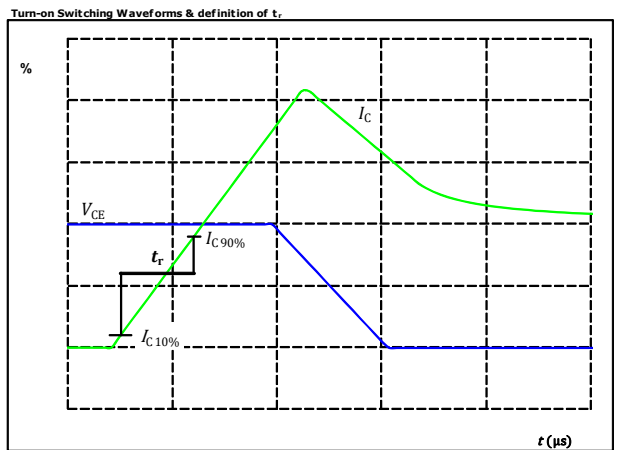

$V_C(100\%) =$	600	V
$I_C(100\%) =$	35	A
$t_r =$	26	ns



Vincotech

Inverter Switching Characteristics

figure 5. FWD

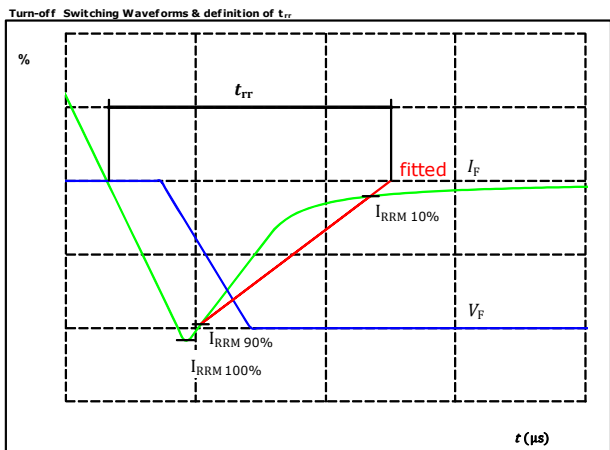

$V_F(100\%) =$	600	V
$I_F(100\%) =$	35	A
$I_{RRM}(100\%) =$	34	A
$t_{rr} =$	493	ns

figure 6. FWD

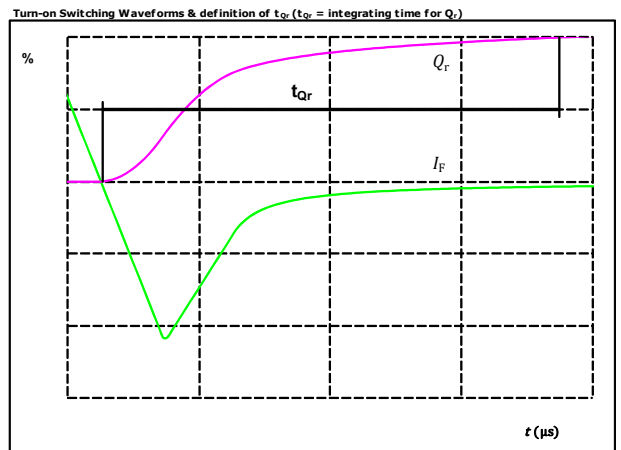

$I_F(100\%) =$	35	A
$Q_r(100\%) =$	7,00	μC



Brake Switching Characteristics

figure 1. IGBT

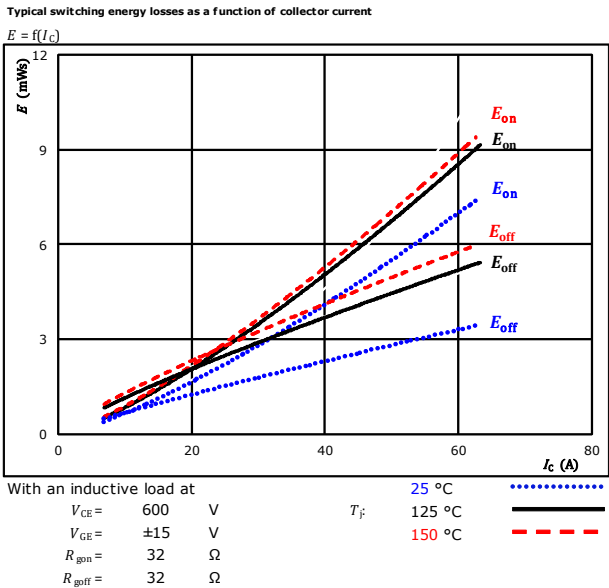

figure 2. IGBT

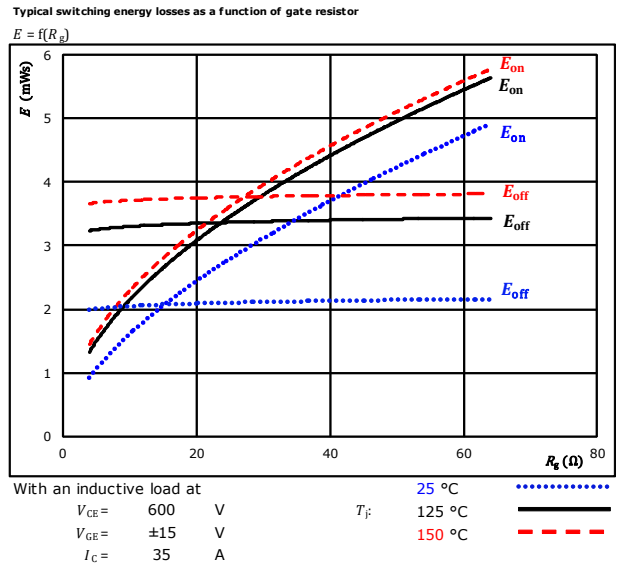

figure 3. FWD

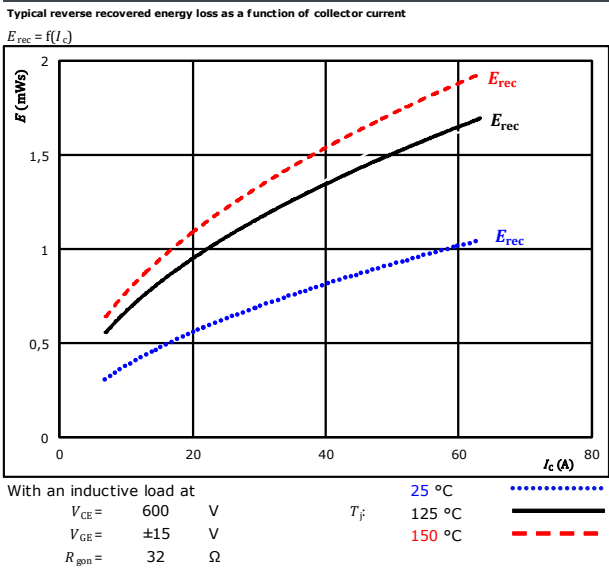
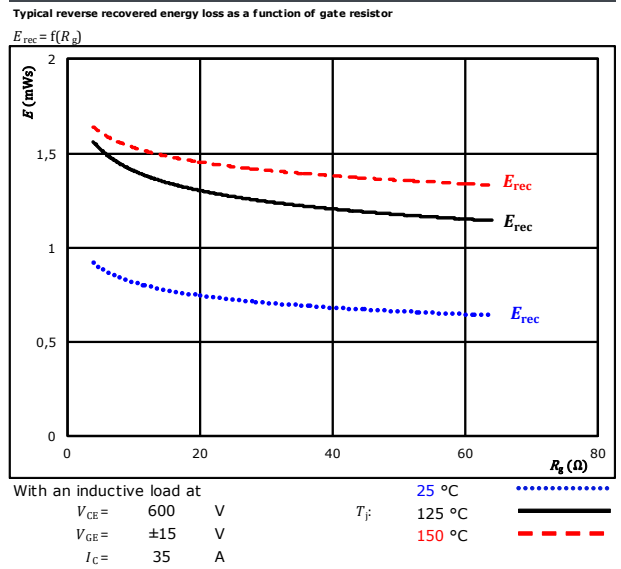

figure 4. FWD





Vincotech

Brake Switching Characteristics

figure 5. IGBT

Typical switching times as a function of collector current

$$t = f(I_C)$$

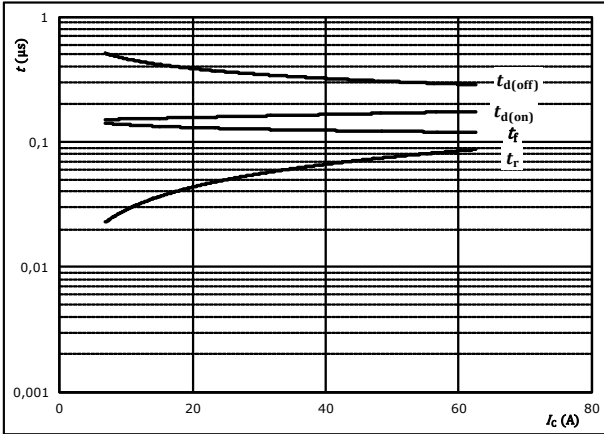

With an inductive load at

$T_j =$	150	°C
$V_{CE} =$	600	V
$V_{GE} =$	±15	V
$R_{g(on)} =$	32	Ω
$R_{g(off)} =$	32	Ω

figure 6. IGBT

Typical switching times as a function of gate resistor

$$t = f(R_g)$$

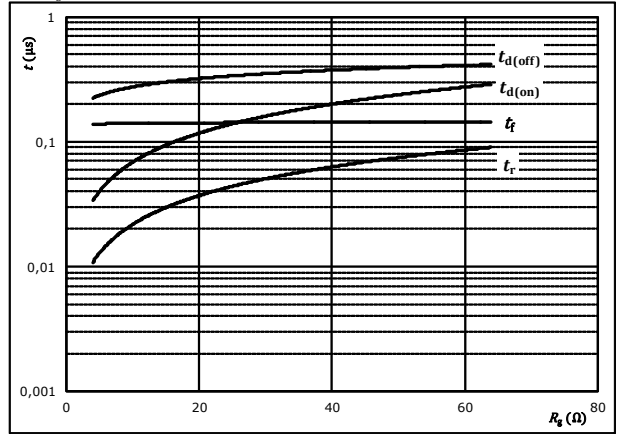

With an inductive load at

$T_j =$	150	°C
$V_{CE} =$	600	V
$V_{GE} =$	±15	V
$I_C =$	35	A

figure 7. FWD

Typical reverse recovery time as a function of collector current

$$t_{rr} = f(I_C)$$

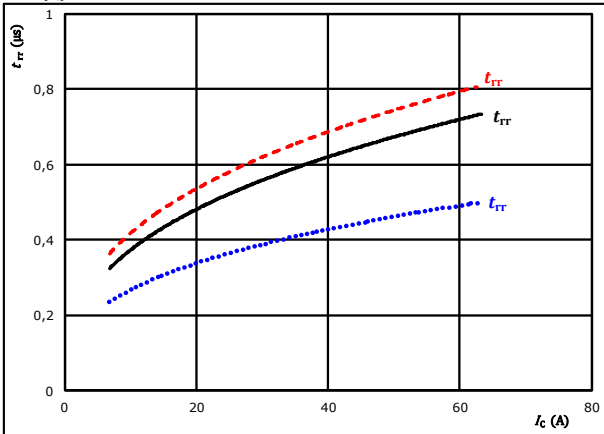

At	$V_{CE} =$	600	V	$T_j =$	25 °C
	$V_{GE} =$	±15	V		125 °C	————
	$R_{g(on)} =$	32	Ω		150 °C	- - - -

figure 8. FWD

Typical reverse recovery time as a function of IGBT turn on gate resistor

$$t_{rr} = f(R_{g(on)})$$

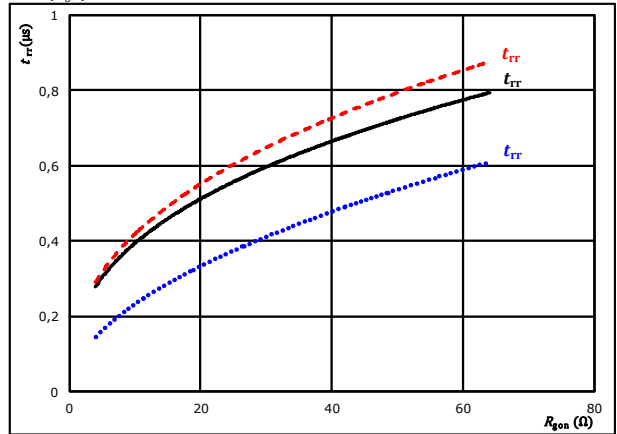

At	$V_{CE} =$	600	V	$T_j =$	25 °C
	$V_{GE} =$	±15	V		125 °C	————
	$I_C =$	35	A		150 °C	- - - -



Brake Switching Characteristics

figure 9. FWD

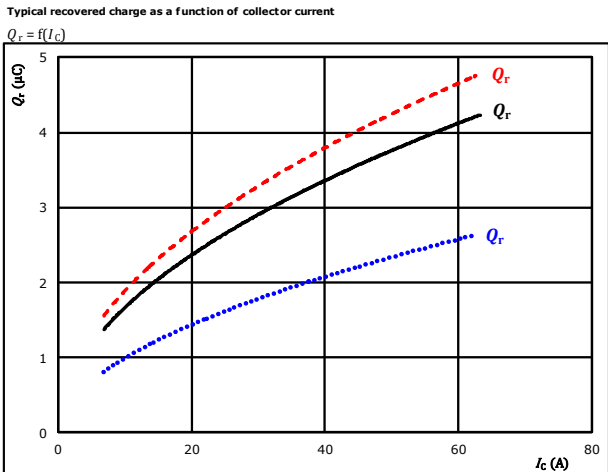

At $V_{CE} = 600$ V $T_j = 25$ °C (dotted blue)
 $V_{GE} = \pm 15$ V $T_j = 125$ °C (solid black)
 $R_{gpn} = 32$ Ω $T_j = 150$ °C (dashed red)

figure 10. FWD

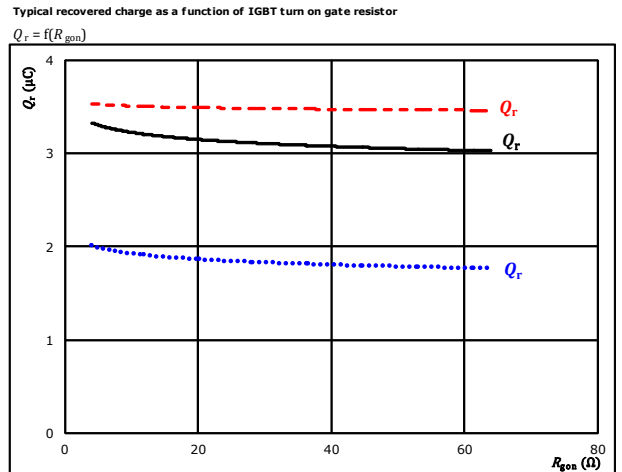

At $V_{CE} = 600$ V $T_j = 25$ °C (dotted blue)
 $V_{GE} = \pm 15$ V $T_j = 125$ °C (solid black)
 $I_c = 35$ A $T_j = 150$ °C (dashed red)

figure 11. FWD

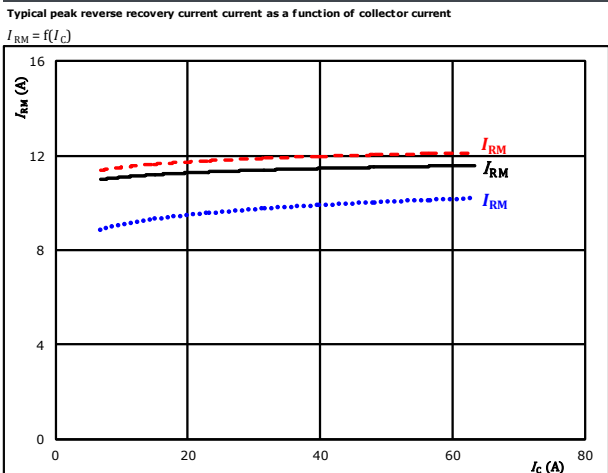

At $V_{CE} = 600$ V $T_j = 25$ °C (dotted blue)
 $V_{GE} = \pm 15$ V $T_j = 125$ °C (solid black)
 $R_{gpn} = 32$ Ω $T_j = 150$ °C (dashed red)

figure 12. FWD

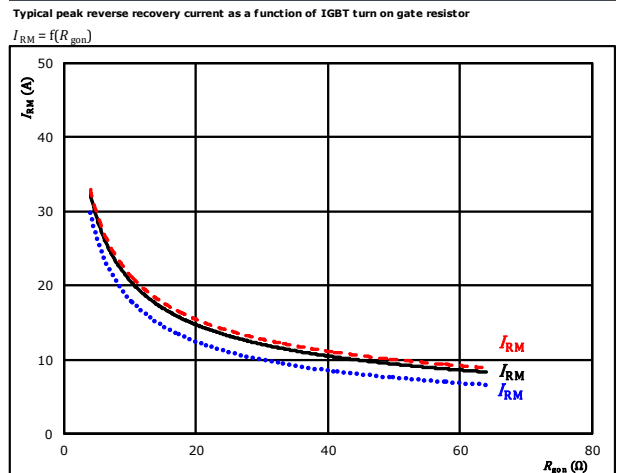

At $V_{CE} = 600$ V $T_j = 25$ °C (dotted blue)
 $V_{GE} = \pm 15$ V $T_j = 125$ °C (solid black)
 $I_c = 35$ A $T_j = 150$ °C (dashed red)



Brake Switching Characteristics

figure 13. FWD

Typical rate of fall of forward and reverse recovery current as a function of collector current
 $di_f/dt, di_{rr}/dt = f(I_c)$

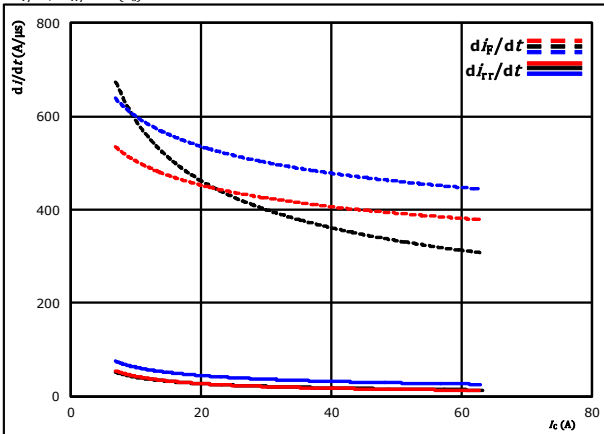

At $V_{CE} = 600$ V $T_j = 25$ °C
 $V_{GE} = \pm 15$ V $T_j = 125$ °C
 $R_{g\text{on}} = 32$ Ω $T_j = 150$ °C

figure 14. FWD

Typical rate of fall of forward and reverse recovery current as a function of IGBT turn on gate resistor
 $di_f/dt, di_{rr}/dt = f(R_{g\text{on}})$

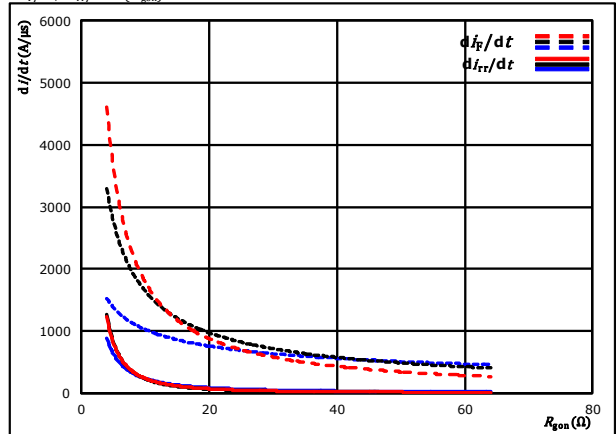

At $V_{CE} = 600$ V $T_j = 25$ °C
 $V_{GE} = \pm 15$ V $T_j = 125$ °C
 $I_c = 35$ A $T_j = 150$ °C

figure 15. IGBT

Reverse bias safe operating area
 $I_c = f(V_{CE})$

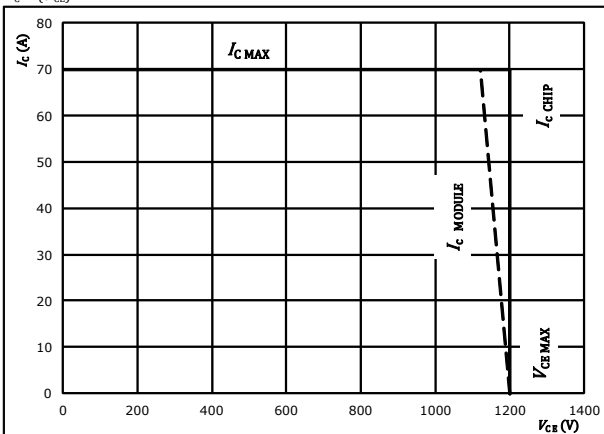

At $T_j = 125$ °C
 $R_{g\text{on}} = 32$ Ω
 $R_{g\text{off}} = 32$ Ω



Brake Switching Definitions

General conditions		
T_j	=	125 °C
R_{gon}	=	32 Ω
R_{goff}	=	32 Ω

figure 1. IGBT

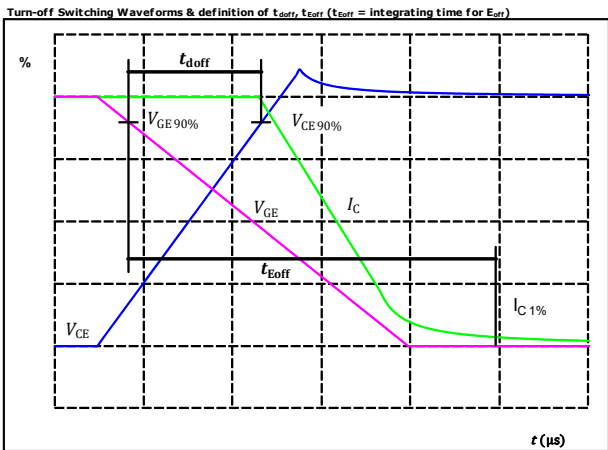

$V_{CE}(0\%) =$	-15	V
$V_{GE}(100\%) =$	15	V
$V_C(100\%) =$	600	V
$I_C(100\%) =$	35	A
$t_{doff} =$	313	ns

figure 2. IGBT

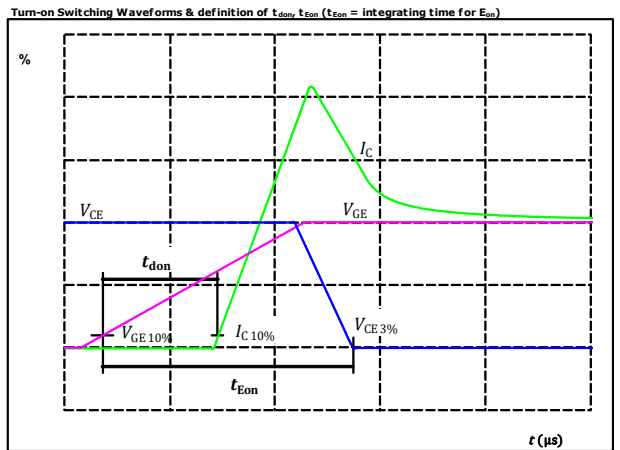

$V_{CE}(0\%) =$	-15	V
$V_{GE}(100\%) =$	15	V
$V_C(100\%) =$	600	V
$I_C(100\%) =$	35	A
$t_{don} =$	165	ns

figure 3. IGBT

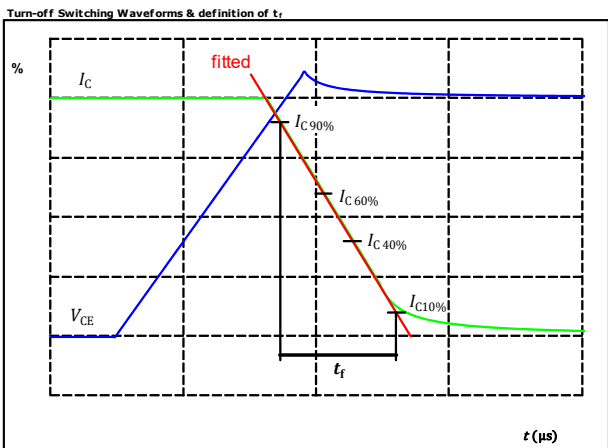

$V_C(100\%) =$	600	V
$I_C(100\%) =$	35	A
$t_f =$	124	ns

figure 4. IGBT

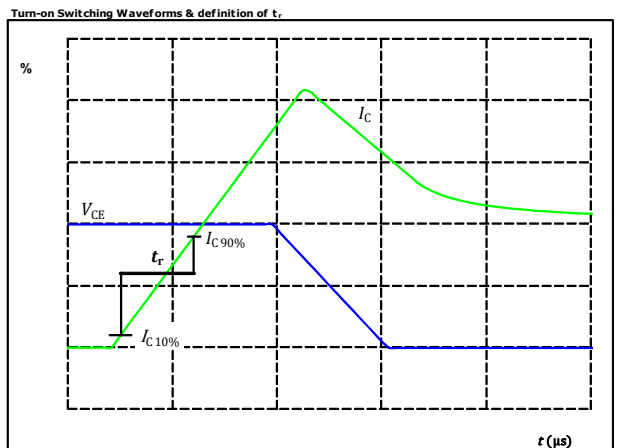

$V_C(100\%) =$	600	V
$I_C(100\%) =$	35	A
$t_r =$	54	ns



Brake Switching Characteristics

figure 5. FWD
 Turn-off Switching Waveforms & definition of t_{rr}

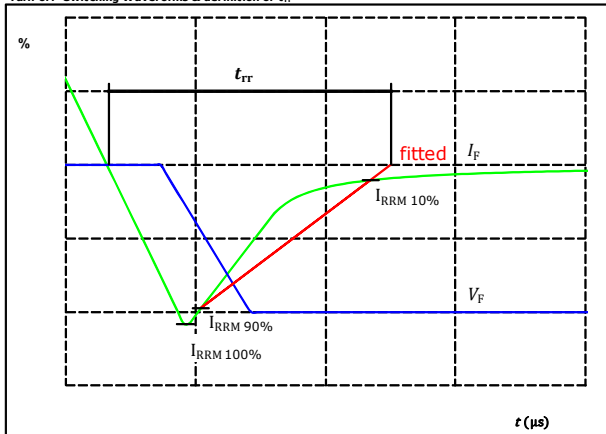

$V_F(100\%) =$	600	V
$I_F(100\%) =$	35	A
$I_{RRM}(100\%) =$	12	A
$t_{rr} =$	574	ns

figure 6. FWD
 Turn-on Switching Waveforms & definition of t_{qr} ($t_{qr} =$ integrating time for Q_r)

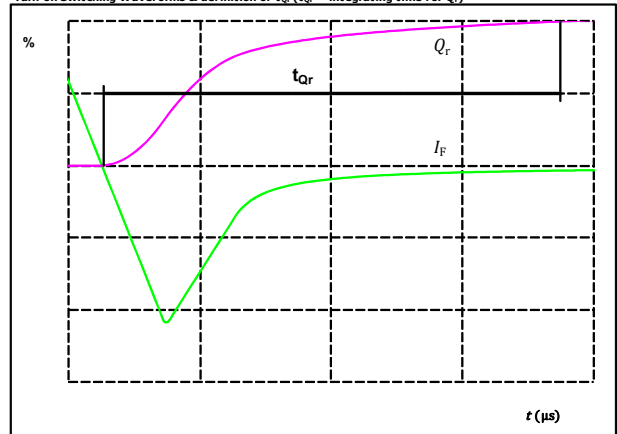

$I_F(100\%) =$	35	A
$Q_r(100\%) =$	3,09	μC



Ordering Code & Marking								
Version			Ordering Code					
without thermal paste 12 mm housing with solder pins			10-E212PMA035SC-L188A48Z					
without thermal paste 12 mm housing with press-fit			10-EY12PMA035SC-L188A48T					
with thermal paste 12 mm housing with solder pins			10-E212PMA035SC-L188A48Z-/3/					
with thermal paste 12 mm housing with press-fit			10-EY12PMA035SC-L188A48T-/3/					
NN-NNNNNNNNNNNN TTTTIVVWWYY UL VIN LLLL SSSS			Name		Date code	UL & VIN	Lot	Serial
			NN-NNNNNNNNNNNN-TTTTIVV		WWYY	UL VIN	LLLLL	SSSS
			Datamatrix	Type&Ver	Lot number	Serial	Date code	
			TTTTTIVV	LLLLL	SSSS	WWYY		

Pin table				Outline	
Pin	X	Y	Function		
1	25,6	6,4	ACIn2	<p>Solder pin</p>	
2	22,4	6,4	ACIn2		
3	16	9,6	ACIn1		
4	12,8	9,6	ACIn1		
5	9,6	0	DC+Rect		
6	9,6	3,2	DC+Rect		
7	0	0	DC-Rect		
8	0	3,2	DC-Rect		
9	0	16	G27		
10	0	19,2	DC-Br		
11	0	22,4	G11		
12	0	25,6	DC-1		
13	0	28,8	DC-1		
14	0	32	G13		
15	0	35,2	DC-2		
16	0	38,4	DC-2		
17	0	41,6	G15		
18	0	44,8	DC-3		
19	0	48	DC-3		
20	9,6	48	Therm1	<p>Tolerance of pinpositions: ±0.4mm at the end of pins Dimension of coordinate axis is only offset without tolerance</p>	
21	19,2	48	Therm2		
22	28,8	48	G16		
23	32	48	Ph3		
24	32	44,8	Ph3		
25	32	35,2	G14		
26	32	32	Ph2		
27	32	28,8	Ph2		
28	32	19,2	G12		
29	32	16	Ph1		
30	32	12,8	Ph1		
31	32	3,2	ACIn3		
32	32	0	ACIn3		
33	22,4	19,2	DC+Inv		
34	22,4	16	DC+Inv		
35	9,6	19,2	Br		



Vincotech

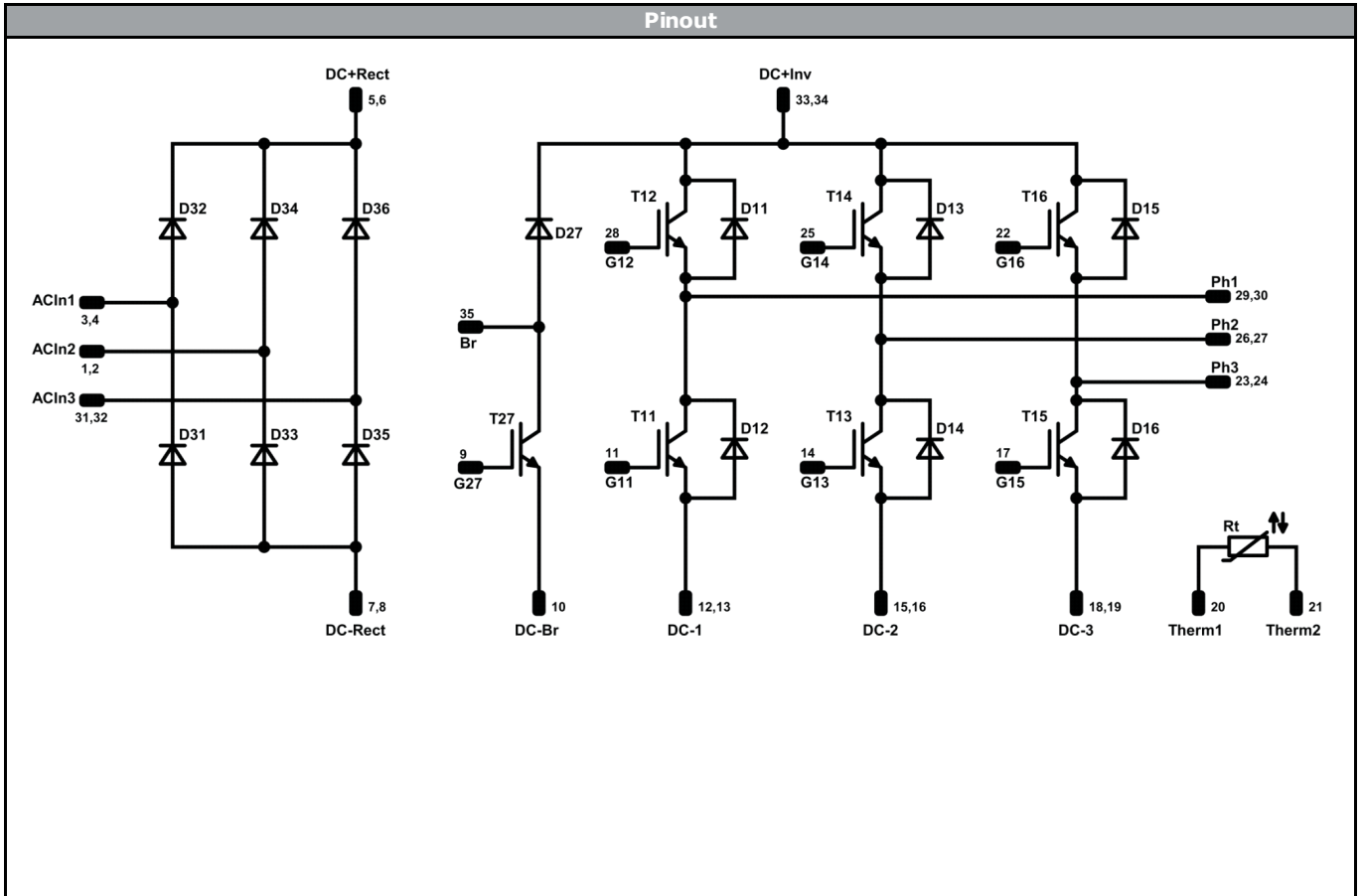

Identification					
ID	Component	Voltage	Current	Function	Comment
T11, T12, T13, T14, T15, T16	IGBT	1200 V	35 A	Inverter Switch	
D11, D12, D13, D14, D15, D16	FWD	1200 V	35 A	Inverter Diode	
T27	IGBT	1200 V	35 A	Brake Switch	
D27	FWD	1200 V	10 A	Brake Diode	
D31, D32, D33, D34, D35, D36	Rectifier	1600 V	45 A	Rectifier Diode	
Rt	NTC			Thermistor	



Vincotech

Packaging instruction			
Standard packaging quantity (SPQ) 100	>SPQ	Standard	<SPQ Sample

Handling instruction
Handling instructions for <i>flow</i> E2 packages see vincotech.com website.

Package data
Package data for <i>flow</i> E2 packages see vincotech.com website.

UL recognition and file number
This device is certified according to UL 1557 standard, UL file number E192116. For more information see vincotech.com website. 

Document No.:	Date:	Modification:	Pages
10-Ex12PMA035SC-L188A48x-D4-14	27 May. 2019	Outline updated	28

DISCLAIMER

The information, specifications, procedures, methods and recommendations herein (together "information") are presented by Vincotech to reader in good faith, are believed to be accurate and reliable, but may well be incomplete and/or not applicable to all conditions or situations that may exist or occur. Vincotech reserves the right to make any changes without further notice to any products to improve reliability, function or design. No representation, guarantee or warranty is made to reader as to the accuracy, reliability or completeness of said information or that the application or use of any of the same will avoid hazards, accidents, losses, damages or injury of any kind to persons or property or that the same will not infringe third parties rights or give desired results. It is reader's sole responsibility to test and determine the suitability of the information and the product for reader's intended use.

LIFE SUPPORT POLICY

Vincotech products are not authorised for use as critical components in life support devices or systems without the express written approval of Vincotech.

As used herein:

1. Life support devices or systems are devices or systems which, (a) are intended for surgical implant into the body, or (b) support or sustain life, or (c) whose failure to perform when properly used in accordance with instructions for use provided in labelling can be reasonably expected to result in significant injury to the user.
2. A critical component is any component of a life support device or system whose failure to perform can be reasonably expected to cause the failure of the life support device or system, or to affect its safety or effectiveness.