

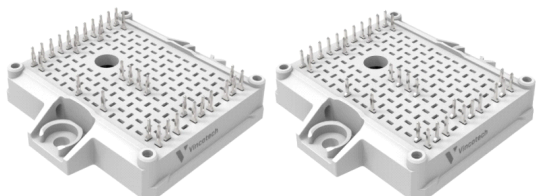
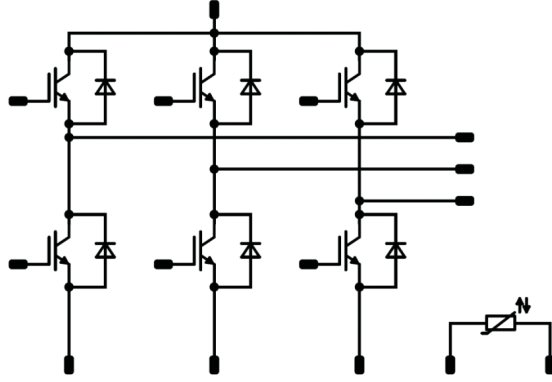

Vincotech

10-EY126PA075SC-L197F48T
10-E2126PA075SC-L197F48Z
 datasheet

<i>flow</i> PACK E2	1200 V / 75 A
<div style="border: 1px solid black; padding: 5px; margin-bottom: 5px;"> <p style="text-align: center; margin: 0;">Features</p> <ul style="list-style-type: none"> Trench IGBT4 chip technology Compact design Integrated NTC </div> <div style="border: 1px solid black; padding: 5px; margin-bottom: 5px;"> <p style="text-align: center; margin: 0;">Target applications</p> <ul style="list-style-type: none"> Industrial Drives UPS </div> <div style="border: 1px solid black; padding: 5px;"> <p style="text-align: center; margin: 0;">Types</p> <ul style="list-style-type: none"> 10-EY126PA075SC-L197F48T 10-E2126PA075SC-L197F48Z </div>	<div style="border: 1px solid black; padding: 5px; margin-bottom: 5px;"> <p style="text-align: center; margin: 0;"><i>flow</i> E2 12 mm housing</p>  <div style="display: flex; justify-content: space-around; margin-top: 5px;"> Press-fit pin Solder pin </div> </div> <div style="border: 1px solid black; padding: 5px;"> <p style="text-align: center; margin: 0;">Schematic</p>  </div>

Maximum Ratings

$T_j = 25\text{ °C}$, unless otherwise specified

Parameter	Symbol	Condition	Value	Unit
Inverter Switch				
Collector-emitter voltage	V_{CES}		1200	V
Collector current	I_C	$T_j = T_{jmax}$ $T_s = 80\text{ °C}$	69	A
Repetitive peak collector current	I_{CRM}	t_p limited by T_{jmax}	225	A
Total power dissipation	P_{tot}	$T_j = T_{jmax}$ $T_s = 80\text{ °C}$	150	W
Gate-emitter voltage	V_{GES}		±20	V
Short circuit ratings	t_{SC}	$V_{GE} = 15\text{ V}$ $V_{CE} = 800\text{ V}$ $T_j = 150\text{ °C}$	10	µs
Maximum junction temperature	T_{jmax}		175	°C



Maximum Ratings

$T_j = 25\text{ °C}$, unless otherwise specified

Parameter	Symbol	Condition	Value	Unit
Inverter Diode				
Peak repetitive reverse voltage	V_{RRM}		1200	V
Continuous (direct) forward current	I_F	$T_j = T_{jmax}$ $T_s = 80\text{ °C}$	70	A
Repetitive peak forward current	I_{FRM}		150	A
Total power dissipation	P_{tot}	$T_j = T_{jmax}$ $T_s = 80\text{ °C}$	118	W
Maximum junction temperature	T_{jmax}		175	°C

Module Properties

General Properties

Stray inductance	L_P		40	nH
------------------	-------	--	----	----

Thermal Properties

Storage temperature	T_{stg}		-40...+125	°C
Operation temperature under switching condition	T_{jop}		-40...($T_{jmax} - 25$)	°C

Isolation Properties

Isolation voltage	V_{isol}	DC Test Voltage* $t_p = 2\text{ s}$	6000	V
Creepage distance			min. 12,7	mm
Clearance			9,08	mm
Comparative Tracking Index	CTI		≥ 600	

*100 % tested in production



Characteristic Values

Parameter	Symbol	Conditions					Value			Unit
		V_{GS} [V]	V_{GE} [V]	V_{DS} [V]	I_D [A]	T_j [°C]	Min	Typ	Max	

Inverter Switch

Static

Parameter	Symbol	V_{GS} [V]	V_{GE} [V]	V_{DS} [V]	I_D [A]	T_j [°C]	Min	Typ	Max	Unit
Gate-emitter threshold voltage	$V_{GE(th)}$				0,0026	25	5,3	5,8	6,3	V
Collector-emitter saturation voltage	V_{CESat}	15			75	25 125 150	1,58	1,83 2,12 2,19	2,07	V
Collector-emitter cut-off current	I_{CES}	0	1200			25			1	μA
Gate-emitter leakage current	I_{GES}	20	0			25			120	nA
Internal gate resistance	r_g							10		Ω
Input capacitance	C_{ies}	$f = 1$ Mhz	0	25		25		4300		pF
Reverse transfer capacitance	C_{res}							160		

Thermal

Parameter	Symbol	Conditions	Min	Typ	Max	Unit
Thermal resistance junction to sink	$R_{th(j-s)}$	$\lambda_{paste} = 3,4$ W/mK (PSX)				0,63 K/W

Dynamic

Parameter	Symbol	Conditions	V_{GS} [V]	V_{GE} [V]	V_{DS} [V]	I_D [A]	T_j [°C]	Min	Typ	Max	Unit		
Turn-on delay time	$t_{d(on)}$	$R_{gon} = 2$ Ω $R_{goff} = 2$ Ω					25 125 150		126 138 140		ns		
Rise time	t_r						25 125 150		34 39 41				
Turn-off delay time	$t_{d(off)}$						25 125 150		232 293 310				
Fall time	t_f						25 125 150		71 121 131				
Turn-on energy (per pulse)*	E_{on}		$Q_{iFWD} = 7,2$ μC $Q_{iFWD} = 12,9$ μC $Q_{iFWD} = 14,5$ μC					25 125 150		7,11 10,05 10,70			mWs
Turn-off energy (per pulse)*	E_{off}							25 125 150		4,23 6,49 7,18			

* $L_s = 12$ nH



Vincotech

10-EY126PA075SC-L197F48T
10-E2126PA075SC-L197F48Z
 datasheet

Characteristic Values

Parameter	Symbol	Conditions					Value			Unit
		V_{GE} [V] V_{GS} [V]	V_{CE} [V] V_{DS} [V]	I_C [A] I_D [A]	I_C [A] I_F [A]	T_j [°C]	Min	Typ	Max	

Inverter Diode

Forward voltage	V_F				75	25 125 150		1,74 1,75 1,74	2,05	V
Reverse leakage current	I_R			1200		25			14	μ A

Thermal

Thermal resistance junction to sink	$R_{th(j-s)}$	$\lambda_{paste} = 3,4$ W/mK (PSX)						0,80		K/W
-------------------------------------	---------------	---------------------------------------	--	--	--	--	--	------	--	-----

Dynamic

Peak recovery current	I_{RRM}					25 125 150		42 50 54		A
Reverse recovery time	t_{rr}					25 125 150		323 483 527		ns
Recovered charge	Q_r	$di/dt = 1650$ A/ μ s $di/dt = 1632$ A/ μ s $di/dt = 2053$ A/ μ s	± 15	600	75	25 125 150		7,22 12,87 14,52		μ C
Reverse recovered energy	E_{rec}					25 125 150		2,56 4,68 5,33		mWs
Peak rate of fall of recovery current	$(di_{rr}/dt)_{max}$					25 125 150		139 131 122		A/ μ s

Thermistor

Rated resistance	R					25		5		k Ω
Deviation of R_{100}	$\Delta_{R/R}$	$R_{100} = 493$ Ω				100	-5		+5	%
Power dissipation	P					25		245		mW
Power dissipation constant						25		1,4		mW/K
B-value	$B_{(25/50)}$	Tol. ± 2 %				25		3375		K
B-value	$B_{(25/100)}$	Tol. ± 2 %				25		3437		K
Vincotech NTC Reference									K	



Inverter Switch Characteristics

figure 1. IGBT

Typical output characteristics
 $I_C = f(V_{CE})$

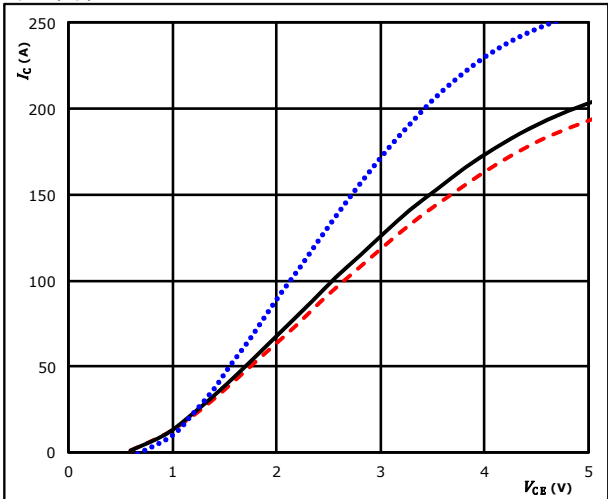

$t_p = 250 \mu s$ $T_j: 25 \text{ }^\circ C$
 $V_{GE} = 15 \text{ V}$ $T_j: 125 \text{ }^\circ C$ ———
 $T_j: 150 \text{ }^\circ C$ - - - -

figure 2. IGBT

Typical output characteristics
 $I_C = f(V_{CE})$

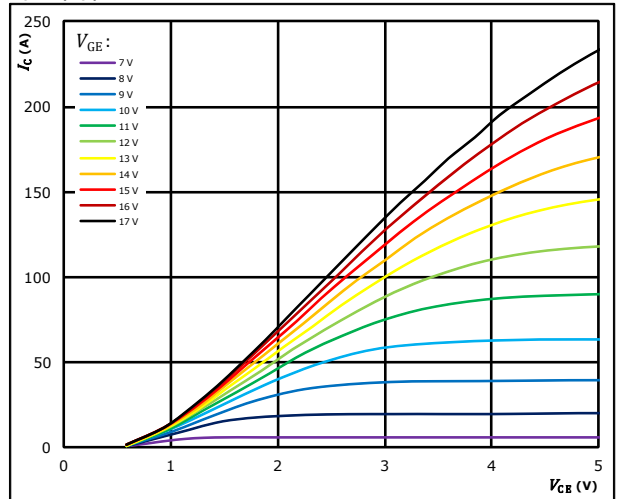

$t_p = 250 \mu s$
 $T_j = 150 \text{ }^\circ C$
 V_{GE} from 7 V to 17 V in steps of 1 V

figure 3. IGBT

Typical transfer characteristics
 $I_C = f(V_{GE})$

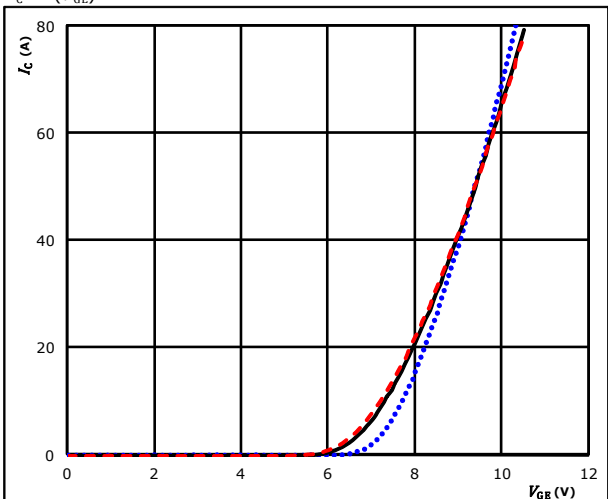

$t_p = 100 \mu s$ $T_j: 25 \text{ }^\circ C$
 $V_{CE} = 10 \text{ V}$ $T_j: 125 \text{ }^\circ C$ ———
 $T_j: 150 \text{ }^\circ C$ - - - -

figure 4. IGBT

Transient thermal impedance as function of pulse duration
 $Z_{th(j-s)} = f(t_p)$

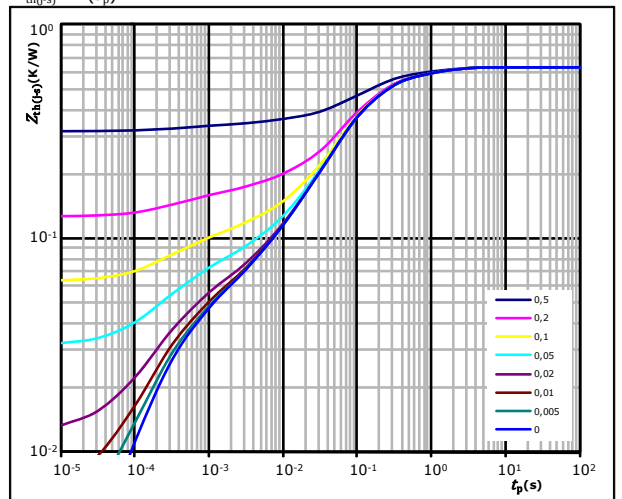

$D = t_p / T$
 $R_{th(j-s)} = 0,63 \text{ K/W}$

IGBT thermal model values

R (K/W)	τ (s)
9,50E-02	1,08E+00
2,44E-01	1,66E-01
2,28E-01	5,71E-02
3,16E-02	3,00E-03
3,42E-02	3,00E-04



Vincotech

Inverter Switch Characteristics

figure 5. IGBT

Safe operating area

$$I_C = f(V_{CE})$$

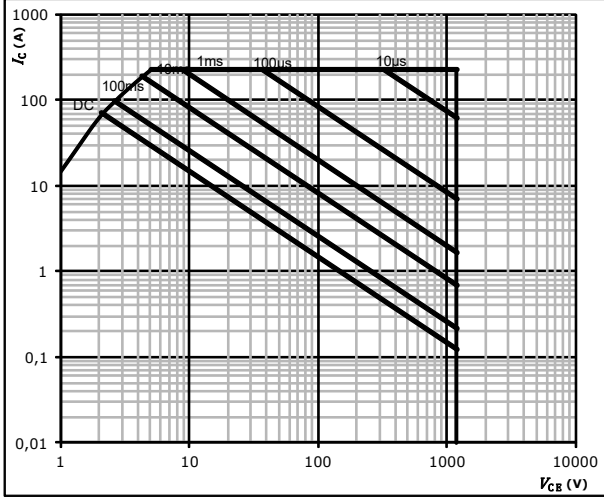

- $D =$ single pulse
- $T_s =$ 80 °C
- $V_{GE} =$ ±15 V
- $T_j =$ T_{jmax}



Inverter Diode Characteristics

figure 1. **FWD**

Typical forward characteristics

$$I_F = f(V_F)$$

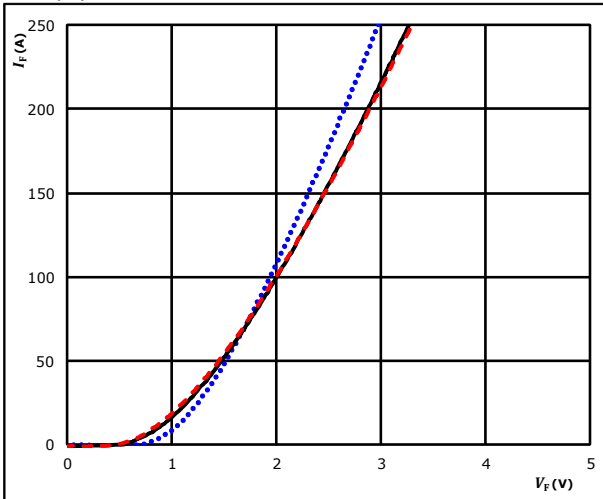

$t_p = 250 \mu s$ $T_j:$ 25 °C
 125 °C ———
 150 °C - - - -

figure 2. **FWD**

Transient thermal impedance as a function of pulse width

$$Z_{th(j-s)} = f(t_p)$$

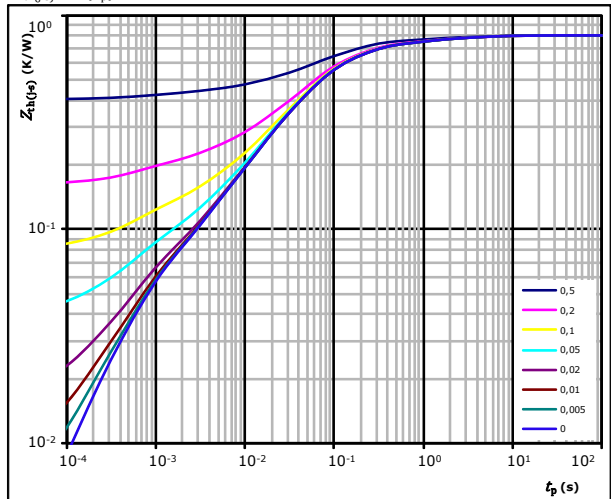

$D = t_p / T$
 $R_{th(j-s)} = 0,80 \text{ K/W}$
 FWD thermal model values

R (K/W)	τ (s)
4,31E-02	3,98E+00
1,05E-01	5,75E-01
3,78E-01	8,41E-02
1,75E-01	2,65E-02
5,72E-02	5,91E-03
4,68E-02	6,59E-04

Thermistor Characteristics

figure 1. **Thermistor**

Typical NTC characteristic
 as a function of temperature

$$R = f(T)$$

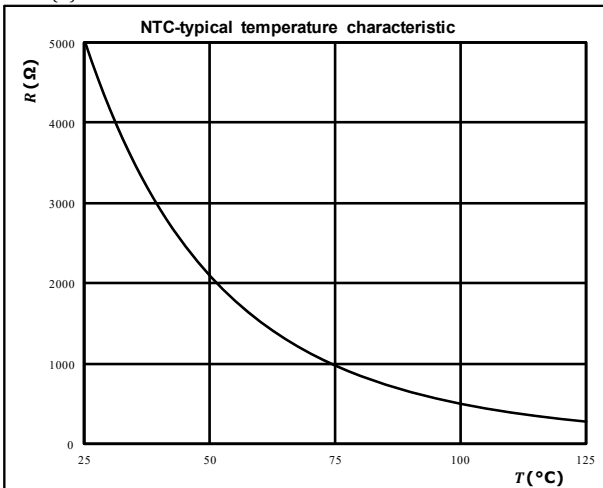



Inverter Switching Characteristics

figure 1. IGBT

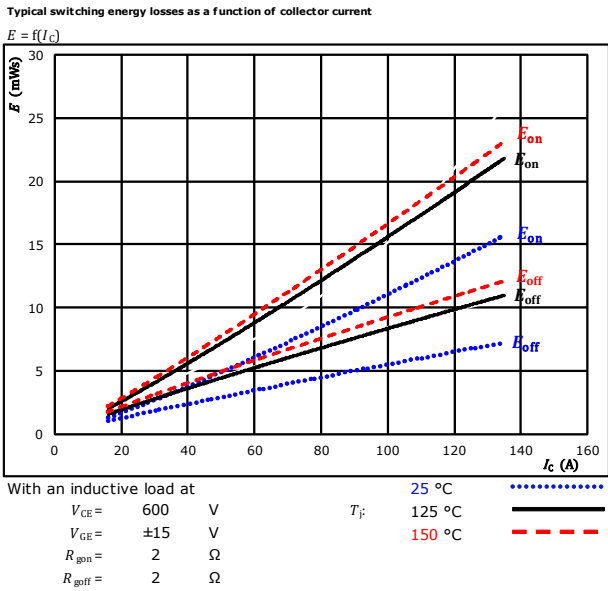

figure 2. IGBT

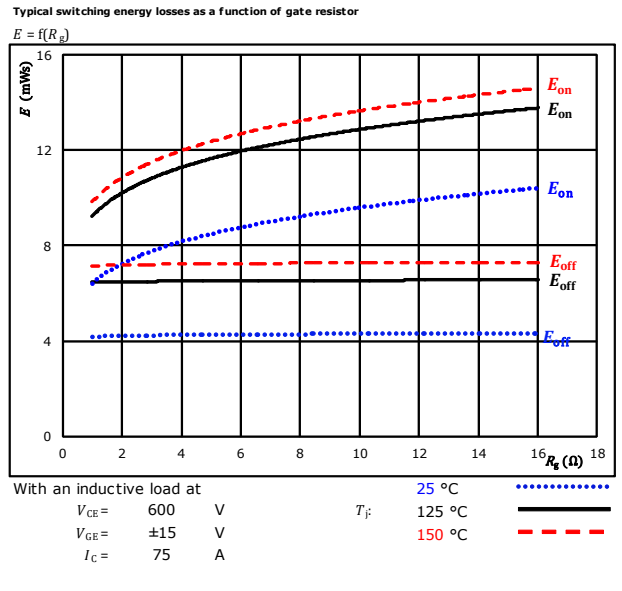

figure 3. FWD

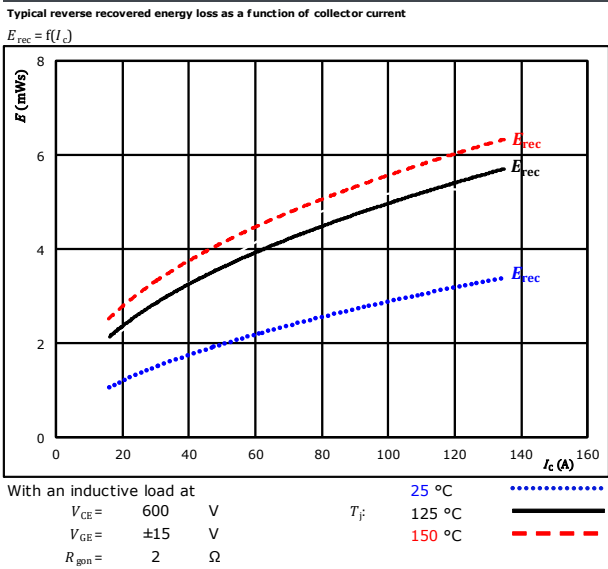
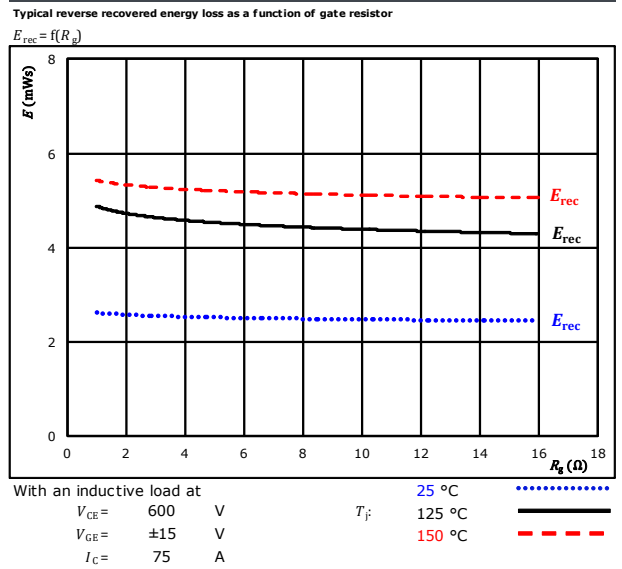

figure 4. FWD





Inverter Switching Characteristics

figure 5. IGBT

Typical switching times as a function of collector current

$$t = f(I_C)$$

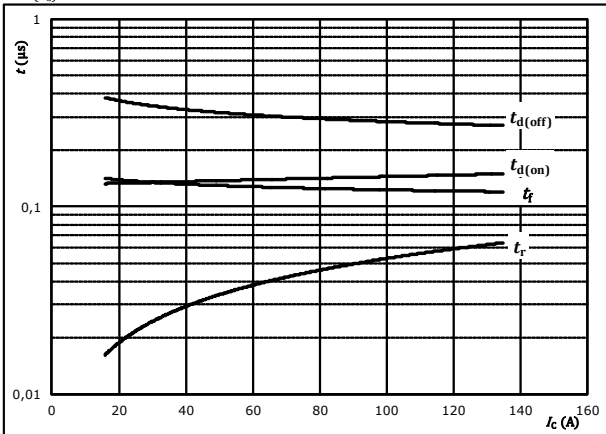

With an inductive load at

$T_j =$	150	°C
$V_{CE} =$	600	V
$V_{GE} =$	±15	V
$R_{g(on)} =$	2	Ω
$R_{g(off)} =$	2	Ω

figure 6. IGBT

Typical switching times as a function of gate resistor

$$t = f(R_g)$$

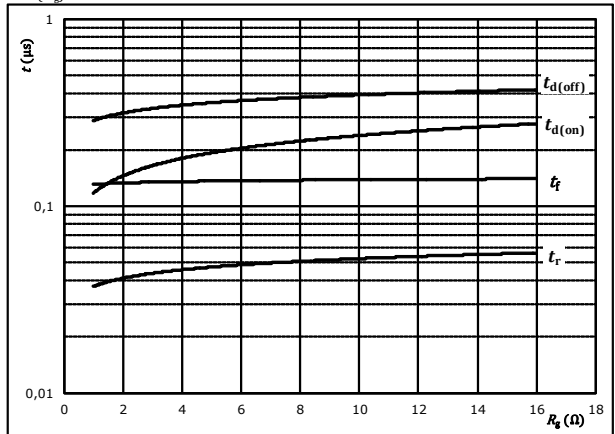

With an inductive load at

$T_j =$	150	°C
$V_{CE} =$	600	V
$V_{GE} =$	±15	V
$I_C =$	75	A

figure 7. FWD

Typical reverse recovery time as a function of collector current

$$t_{rr} = f(I_C)$$

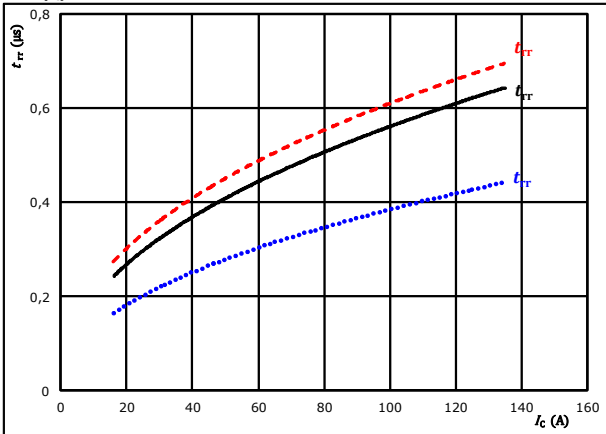

At	$V_{CE} =$	600	V	$T_j:$	25 °C
	$V_{GE} =$	±15	V		125 °C	————
	$R_{g(on)} =$	2	Ω		150 °C	- - - -

figure 8. FWD

Typical reverse recovery time as a function of IGBT turn on gate resistor

$$t_{rr} = f(R_{g(on)})$$

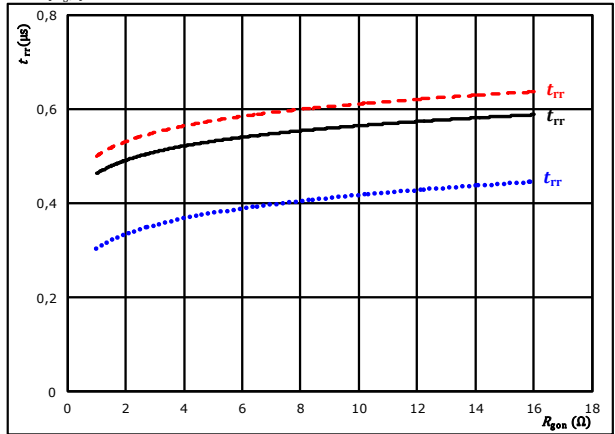

At	$V_{CE} =$	600	V	$T_j:$	25 °C
	$V_{GE} =$	±15	V		125 °C	————
	$I_C =$	75	A		150 °C	- - - -



Inverter Switching Characteristics

figure 9. FWD

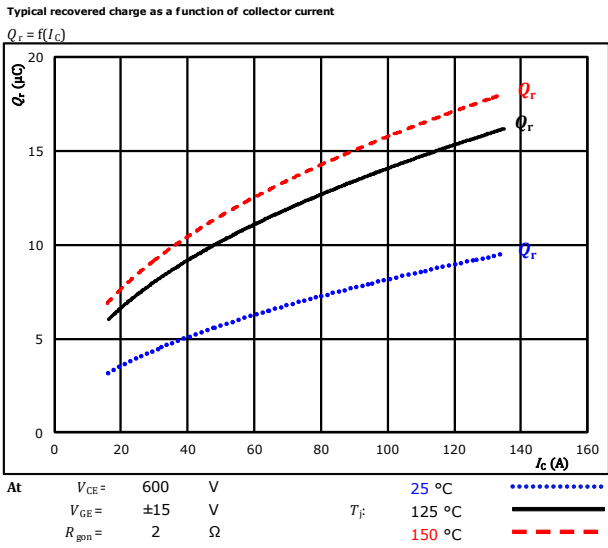

figure 10. FWD

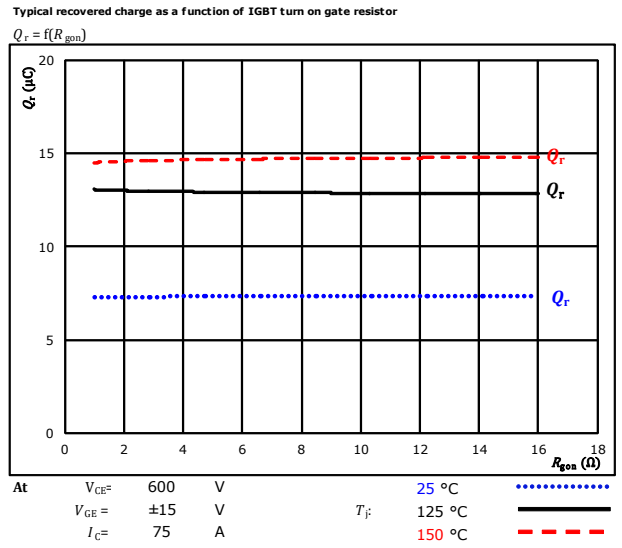

figure 11. FWD

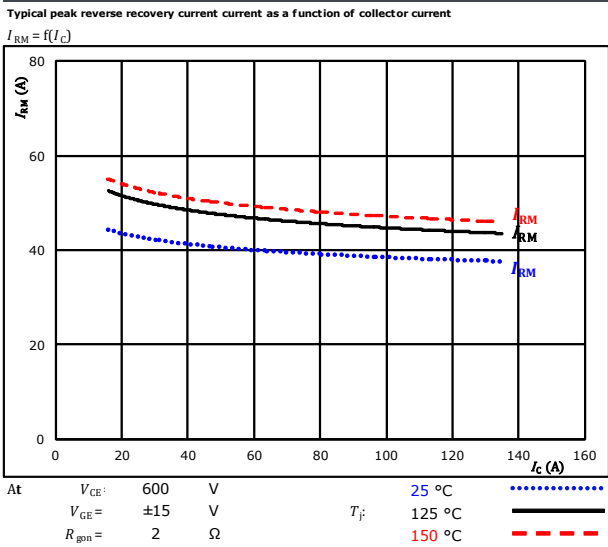
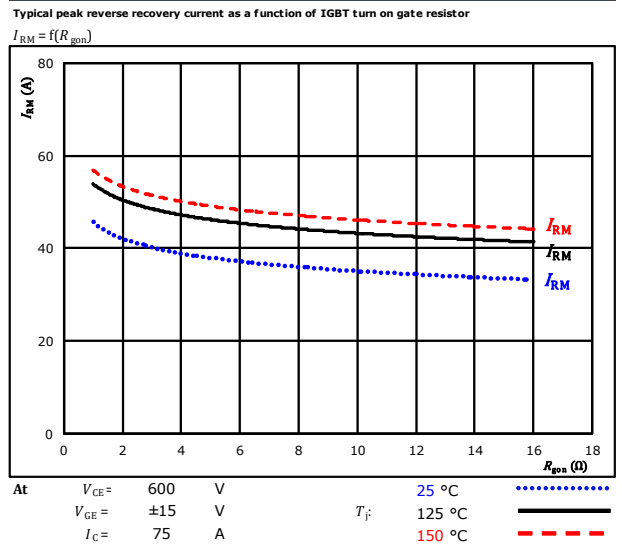

figure 12. FWD





Inverter Switching Characteristics

figure 13. FWD

Typical rate of fall of forward and reverse recovery current as a function of collector current
 $di_f/dt, di_{rr}/dt = f(I_c)$

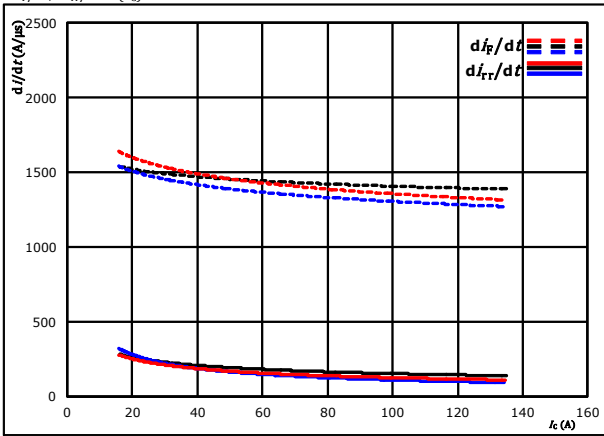

At $V_{CE} = 600$ V $T_j = 25$ °C
 $V_{GE} = \pm 15$ V $T_j = 125$ °C
 $R_{gon} = 2$ Ω $T_j = 150$ °C

figure 14. FWD

Typical rate of fall of forward and reverse recovery current as a function of IGBT turn on gate resistor
 $di_f/dt, di_{rr}/dt = f(R_{gon})$

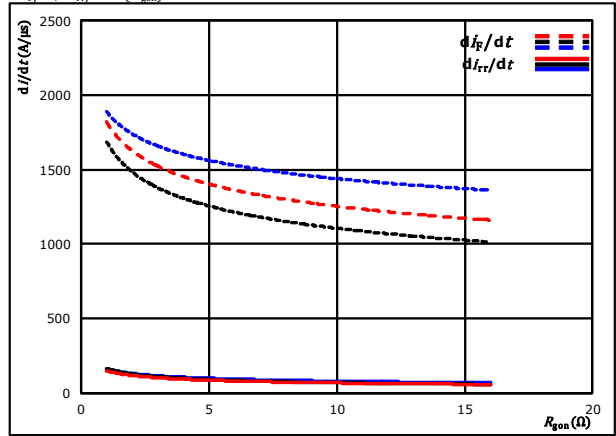

At $V_{CE} = 600$ V $T_j = 25$ °C
 $V_{GE} = \pm 15$ V $T_j = 125$ °C
 $I_c = 75$ A $T_j = 150$ °C

figure 15. IGBT

Reverse bias safe operating area
 $I_c = f(V_{CE})$

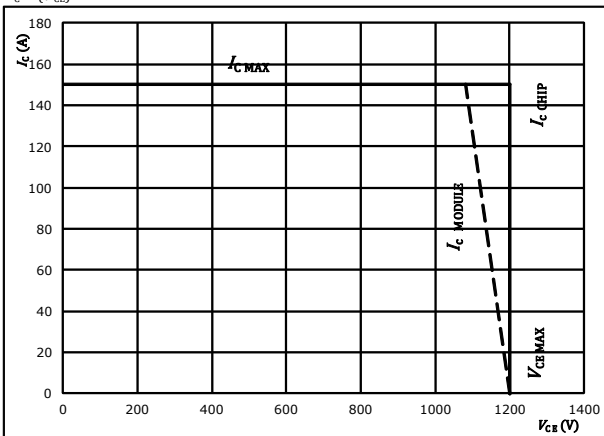

At $T_j = 125$ °C
 $R_{gon} = 2$ Ω
 $R_{goff} = 2$ Ω



Inverter Switching Characteristics

General conditions		
T_j	=	125 °C
R_{gon}	=	2 Ω
R_{goff}	=	2 Ω

figure 1. IGBT

Turn-off Switching Waveforms & definition of t_{doff} , t_{Eoff} (t_{Eoff} = integrating time for E_{off})

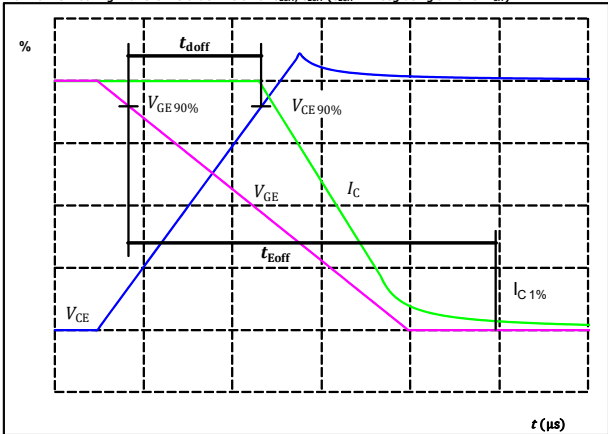

$V_{CE}(0\%) =$	-15	V
$V_{GE}(100\%) =$	15	V
$V_C(100\%) =$	600	V
$I_C(100\%) =$	75	A
$t_{doff} =$	293	ns

figure 2. IGBT

Turn-on Switching Waveforms & definition of t_{don} , t_{Eon} (t_{Eon} = integrating time for E_{on})

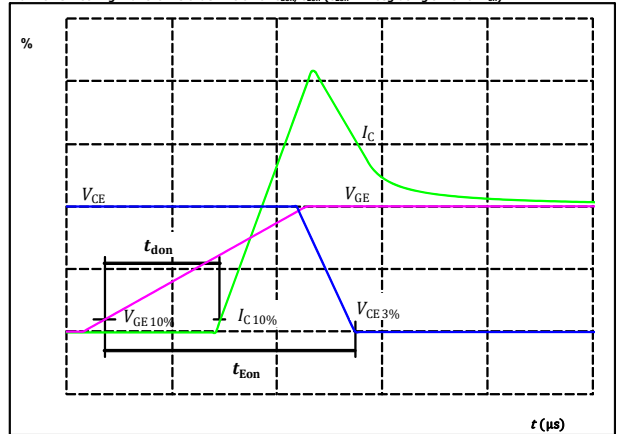

$V_{CE}(0\%) =$	-15	V
$V_{GE}(100\%) =$	15	V
$V_C(100\%) =$	600	V
$I_C(100\%) =$	75	A
$t_{don} =$	138	ns

figure 3. IGBT

Turn-off Switching Waveforms & definition of t_r

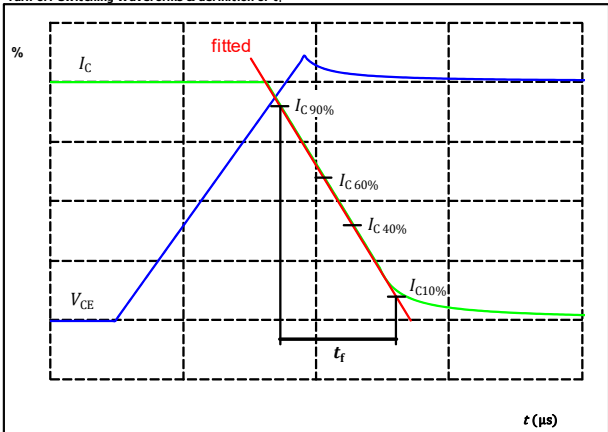

$V_C(100\%) =$	600	V
$I_C(100\%) =$	75	A
$t_r =$	121	ns

figure 4. IGBT

Turn-on Switching Waveforms & definition of t_r

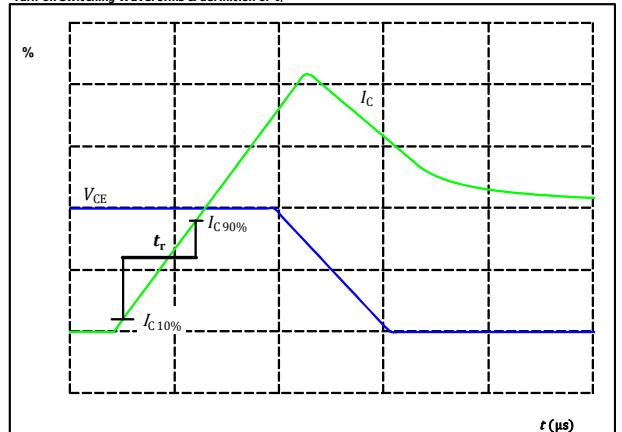

$V_C(100\%) =$	600	V
$I_C(100\%) =$	75	A
$t_r =$	39	ns



Vincotech

10-EY126PA075SC-L197F48T
10-E2126PA075SC-L197F48Z
 datasheet

Inverter Switching Characteristics

figure 5. FWD

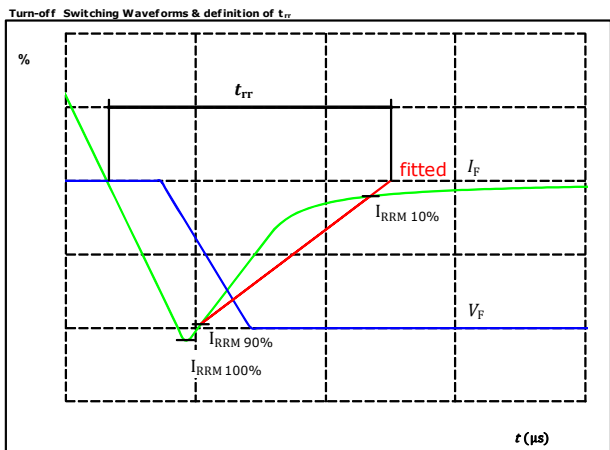

$V_F(100\%) =$	600	V
$I_F(100\%) =$	75	A
$I_{RRM}(100\%) =$	50	A
$t_{rr} =$	483	ns

figure 6. FWD

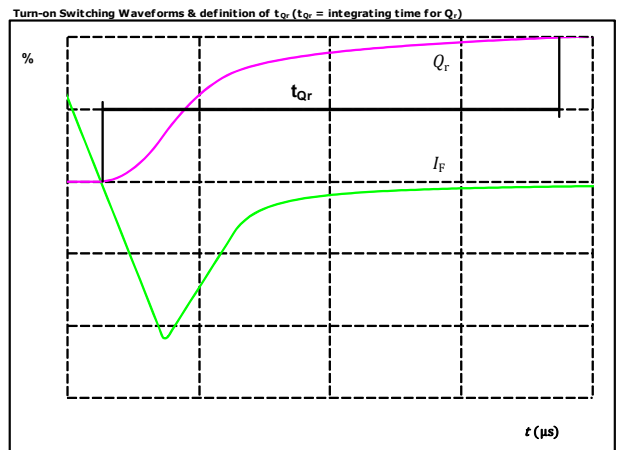

$I_F(100\%) =$	75	A
$Q_r(100\%) =$	12,87	μC



10-EY126PA075SC-L197F48T
10-E2126PA075SC-L197F48Z
 datasheet

Vincotech

Ordering Code & Marking								
Version			Ordering Code					
without thermal paste 12mm housing with Press-fit pins			10-EY126PA075SC-L197F48T					
with thermal paste 12mm housing with Press-fit pins			10-EY126PA075SC-L197F48T-/3/					
without thermal paste 12mm housing with solder pins			10-E2126PA075SC-L197F48Z					
with thermal paste 12mm housing with solder pins			10-E2126PA075SC-L197F48Z-/3/					
NN-NNNNNNNNNNNN TTTTWWWWYY UL VIN LLLL SSSS			Text	Name	Date code	UL & VIN	Lot	Serial
				NN-NNNNNNNNNNNN-TTTTWW	WWYY	UL VIN	LLLL	SSSS
			Datamatrix	Type&Ver	Lot number	Serial	Date code	
			TTTTWW	LLLL	SSSS	WWYY		

Pin table [mm]			
Pin	X	Y	Function
1	32	3,2	G16
2	32	0	Ph3
3	28,8	0	Ph3
4	25,6	0	Ph3
5	19,2	0	Ph2
6	16	0	Ph2
7	12,8	0	Ph2
8	12,8	3,2	G14
9	6,4	0	Ph1
10	3,2	0	Ph1
11	0	0	Ph1
12	0	3,2	G12
13	0	19,2	Therm1
14	0	28,8	Therm2
15	0	44,8	G11
16	0	48	DC-1
17	3,2	48	DC-1
18	6,4	48	DC-1
19	9,6	48	DC-1
20	12,8	48	DC-2
21	12,8	44,8	G13
22	16	48	DC-2
23	19,2	48	DC-2
24	22,4	48	DC-2
25	22,4	44,8	G15
26	25,6	48	DC-3
27	28,8	48	DC-3
28	32	48	DC-3
29	32	44,8	DC-3
30	12,8	25,6	DC+
31	12,8	22,4	DC+
32	12,8	19,2	DC+
33	12,8	16	DC+

Outline

center of press-fit pinhead
for connection parameter see the handling instruction

L197F48T

L197F48Z

Tolerance of pinpositions: ±0.4mm at the end of pins
Dimension of coordinate axis is only offset without tolerance



Vincotech

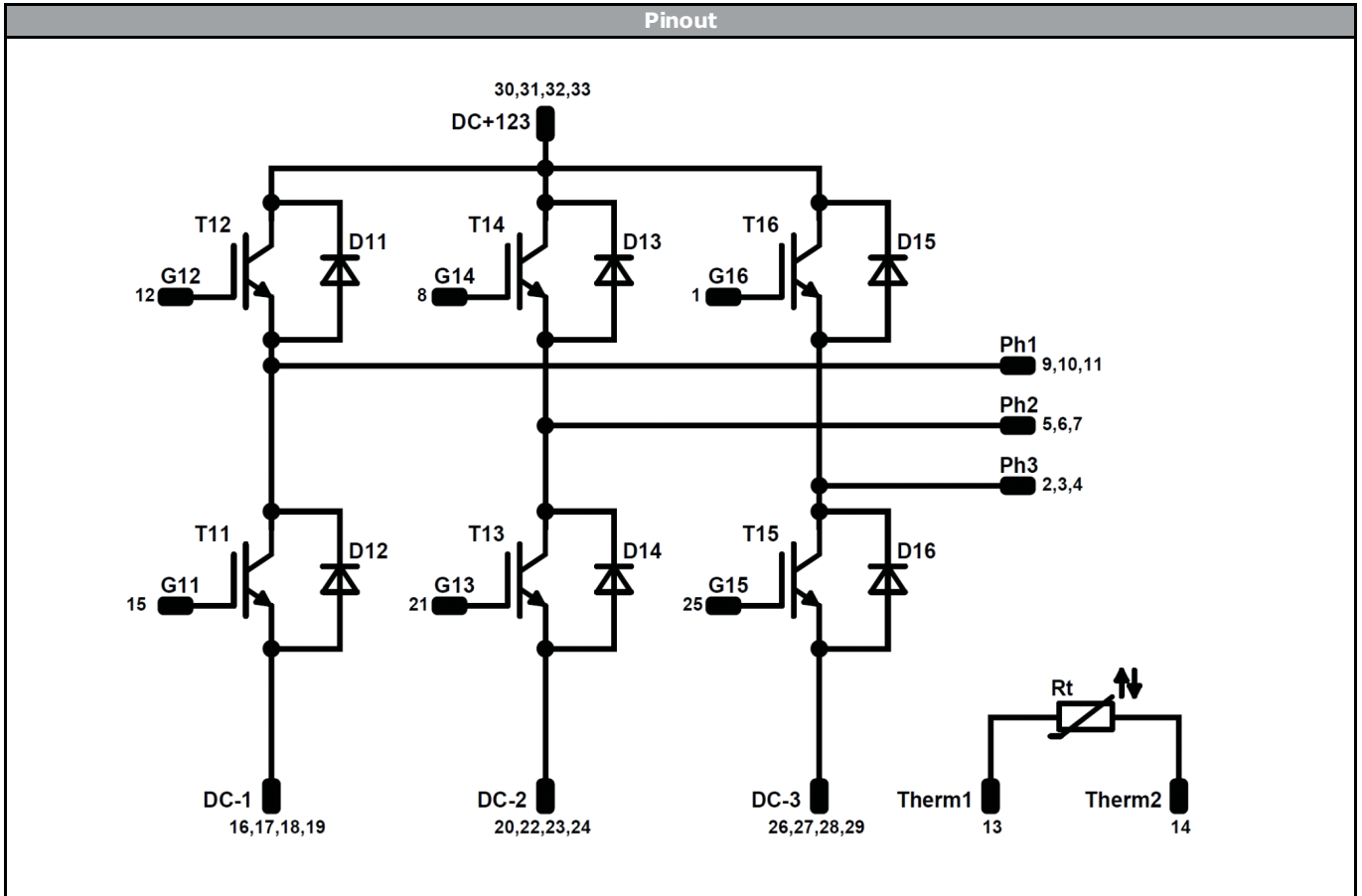

Identification					
ID	Component	Voltage	Current	Function	Comment
T11, T12, T13, T14, T15, T16	IGBT	1200 V	75 A	Inverter Switch	
D11, D12, D13, D14, D15, D16	FWD	1200 V	75 A	Inverter Diode	
Rt	NTC			Thermistor	



Vincotech

10-EY126PA075SC-L197F48T
10-E2126PA075SC-L197F48Z
datasheet

Packaging instruction			
Standard packaging quantity (SPQ) 100	>SPQ	Standard	<SPQ Sample

Handling instruction
Handling instructions for <i>flow</i> E2 packages see vincotech.com website.

Package data
Package data for <i>flow</i> E2 packages see vincotech.com website.

UL recognition and file number
This device is certified according to UL 1557 standard, UL file number E192116. For more information see vincotech.com website. 

Document No.:	Date:	Modification:	Pages
10-Ex126PA075SC-L197F48x-D3-14	20 Dec. 2018	Added Z option to ordering code , Corrected Cr&Cl values	1,2,14

DISCLAIMER

The information, specifications, procedures, methods and recommendations herein (together "information") are presented by Vincotech to reader in good faith, are believed to be accurate and reliable, but may well be incomplete and/or not applicable to all conditions or situations that may exist or occur. Vincotech reserves the right to make any changes without further notice to any products to improve reliability, function or design. No representation, guarantee or warranty is made to reader as to the accuracy, reliability or completeness of said information or that the application or use of any of the same will avoid hazards, accidents, losses, damages or injury of any kind to persons or property or that the same will not infringe third parties rights or give desired results. It is reader's sole responsibility to test and determine the suitability of the information and the product for reader's intended use.

LIFE SUPPORT POLICY

Vincotech products are not authorised for use as critical components in life support devices or systems without the express written approval of Vincotech.

As used herein:

1. Life support devices or systems are devices or systems which, (a) are intended for surgical implant into the body, or (b) support or sustain life, or (c) whose failure to perform when properly used in accordance with instructions for use provided in labelling can be reasonably expected to result in significant injury to the user.
2. A critical component is any component of a life support device or system whose failure to perform can be reasonably expected to cause the failure of the life support device or system, or to affect its safety or effectiveness.