



<i>flowPACK E2</i>	1200 V / 75 A
<div style="border: 1px solid black; padding: 5px; margin-bottom: 10px;"> <p style="text-align: center; background-color: #ccc; margin: 0;">Features</p> <ul style="list-style-type: none"> IGBT Mitsubishi gen 7 technology with low V_{CEsat} and Improved EMC behavior Standard industrial package Built-in NTC </div> <div style="border: 1px solid black; padding: 5px; margin-bottom: 10px;"> <p style="text-align: center; background-color: #ccc; margin: 0;">Target applications</p> <ul style="list-style-type: none"> Industrial Drives UPS </div> <div style="border: 1px solid black; padding: 5px;"> <p style="text-align: center; background-color: #ccc; margin: 0;">Types</p> <ul style="list-style-type: none"> 10-EY126PA075M7-L197F78T 10-E2126PA075M7-L197F78Z </div>	<div style="border: 1px solid black; padding: 5px; margin-bottom: 10px;"> <p style="text-align: center; background-color: #ccc; margin: 0;"><i>flow E2 12 mm housing</i></p> <div style="display: flex; justify-content: space-around; align-items: center;"> </div> <div style="display: flex; justify-content: space-around; margin-top: 5px;"> Press-fit pin Solder pin </div> </div> <div style="border: 1px solid black; padding: 5px;"> <p style="text-align: center; background-color: #ccc; margin: 0;">Schematic</p> </div>

Maximum Ratings

$T_j = 25\text{ °C}$, unless otherwise specified

Parameter	Symbol	Condition	Value	Unit
Inverter Switch				
Collector-emitter voltage	V_{CES}		1200	V
Collector current	I_C	$T_j = T_{jmax}$ $T_s = 80\text{ °C}$	74	A
Repetitive peak collector current	I_{CRM}	t_p limited by T_{jmax}	150	A
Total power dissipation	P_{tot}	$T_j = T_{jmax}$ $T_s = 80\text{ °C}$	135	W
Gate-emitter voltage	V_{GES}		± 20	V
Maximum junction temperature	T_{jmax}		175	$^{\circ}\text{C}$



Maximum Ratings

$T_j = 25\text{ °C}$, unless otherwise specified

Parameter	Symbol	Condition	Value	Unit
Inverter Diode				
Peak repetitive reverse voltage	V_{RRM}		1200	V
Continuous (direct) forward current	I_F	$T_j = T_{jmax}$ $T_s = 80\text{ °C}$	72	A
Repetitive peak forward current	I_{FRM}		200	A
Total power dissipation	P_{tot}	$T_j = T_{jmax}$ $T_s = 80\text{ °C}$	121	W
Maximum junction temperature	T_{jmax}		175	°C

Module Properties

Thermal Properties

Storage temperature	T_{stg}		-40...+125	°C
Operation temperature under switching condition	T_{jop}		-40...($T_{jmax} - 25$)	°C

Isolation Properties

Isolation voltage	V_{isol}	DC Test Voltage* $t_p = 2\text{ s}$	6000	V
		AC Voltage $t_p = 1\text{ min}$	2500	V
Creepage distance			min. 12,7	mm
Clearance		with solder pins	9,08	mm
		with Press-fit pins	9,08	mm
Comparative Tracking Index	CTI		≥ 600	

*100 % tested in production



Characteristic Values

Parameter	Symbol	Conditions					Value			Unit
		V_{GS} [V]	V_{GE} [V]	V_{DS} [V]	I_D [A]	T_j [°C]	Min	Typ	Max	

Inverter Switch

Static

Parameter	Symbol	$V_{GE} = V_{CE}$	V_{GS} [V]	V_{GE} [V]	I_D [A]	T_j [°C]	Min	Typ	Max	Unit
Gate-emitter threshold voltage	$V_{GE(th)}$				0,0075	25	5,4	6	6,6	V
Collector-emitter saturation voltage	V_{CESat}		15		75	25 125 150		1,55 1,70 1,75	1,9	V
Collector-emitter cut-off current	I_{CES}		0	1200		25			100	μA
Gate-emitter leakage current	I_{GES}		20	0		25			500	nA
Internal gate resistance	r_g							4		Ω
Input capacitance	C_{ies}							16000		pF
Output capacitance	C_{oes}		0	10		25		480		
Reverse transfer capacitance	C_{res}							190		
Gate charge	Q_g		15	600	75	25		570		nC

Thermal

Parameter	Symbol	Value	Unit
Thermal resistance junction to sink	$R_{th(j-s)}$	$\lambda_{paste} = 3,4$ W/mK (PSX)	K/W

Dynamic

Parameter	Symbol	$R_{gon} = 2 \Omega$ $R_{goff} = 2 \Omega$	V_{GS} [V]	V_{GE} [V]	I_D [A]	T_j [°C]	Min	Typ	Max	Unit
Turn-on delay time	$t_{d(on)}$		±15	600	75	25		197		ns
Rise time	t_r					125		208		
						150		212		
						25		29		
Turn-off delay time	$t_{d(off)}$					125		38		
						150		39		
						25		203		
Fall time	t_f					125		233		
						150		242		
		25		86						
Turn-on energy (per pulse)*	E_{on}	25		5,56						
		125		7,82						
		150		8,50						
Turn-off energy (per pulse)*	E_{off}	25		5,08						
		125		6,80						
		150		7,29						

* $L_s = 12$ nH



Characteristic Values

Parameter	Symbol	Conditions					Value			Unit
		V_{GE} [V]	V_{CE} [V]	I_C [A]	T_j [°C]	Min	Typ	Max		

Inverter Diode

Static

Parameter	Symbol	V_{GE} [V]	V_{CE} [V]	I_C [A]	T_j [°C]	Min	Typ	Max	Unit
Forward voltage	V_F			100	25 125 150		1,82 1,96 1,97	2,1	V
Reverse leakage current	I_R		1200		25			40	μA

Thermal

Parameter	Symbol	Conditions	Value	Unit
Thermal resistance junction to sink	$R_{th(j-s)}$	$\lambda_{paste} = 3,4$ W/mK (PSX)	0,79	K/W

Dynamic

Parameter	Symbol	V_{GE} [V]	V_{CE} [V]	I_C [A]	T_j [°C]	Min	Typ	Max	Unit
Peak recovery current	I_{RRM}				25 125 150		75 77 78		A
Reverse recovery time	t_{rr}				25 125 150		278 432 459		ns
Recovered charge	Q_r			±15	600	75	8,54 13,39 15,31		μC
Reverse recovered energy	E_{rec}				25 125 150		3,20 5,19 6,00		mWs
Peak rate of fall of recovery current	$(di_{rr}/dt)_{max}$				25 125 150		802 614 544		A/μs

Thermistor

Parameter	Symbol	Conditions	Value	Unit
Rated resistance	R		5	kΩ
Deviation of R_{100}	$\Delta_{R/R}$	$R_{100} = 493$ Ω	-5	+5 %
Power dissipation	P		245	mW
Power dissipation constant			1,4	mW/K
B-value	$B_{(25/50)}$	Tol. ±2 %	3375	K
B-value	$B_{(25/100)}$	Tol. ±2 %	3437	K
Vincotech NTC Reference				K



Inverter Switch Characteristics

figure 1. IGBT

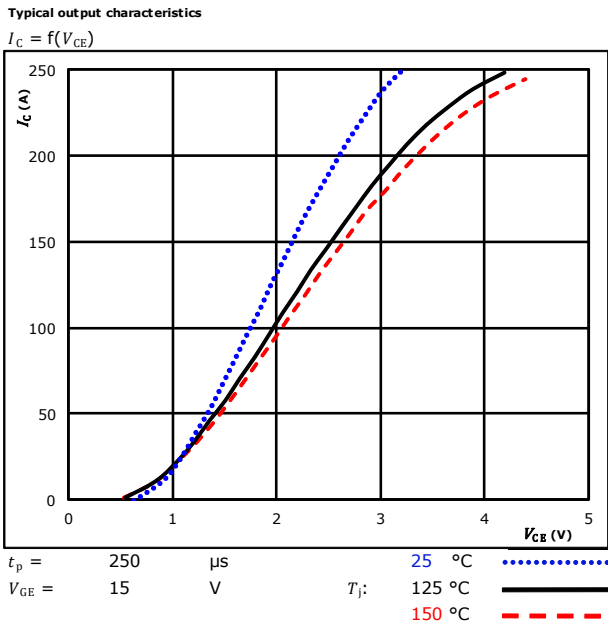

figure 2. IGBT

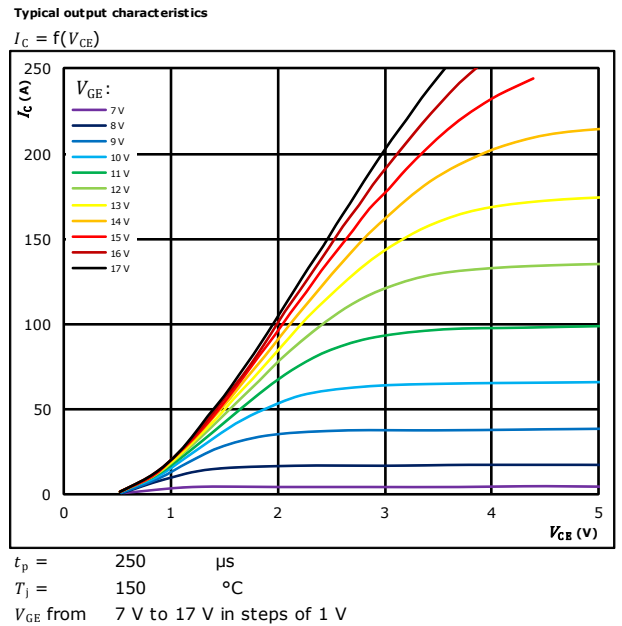

figure 3. IGBT

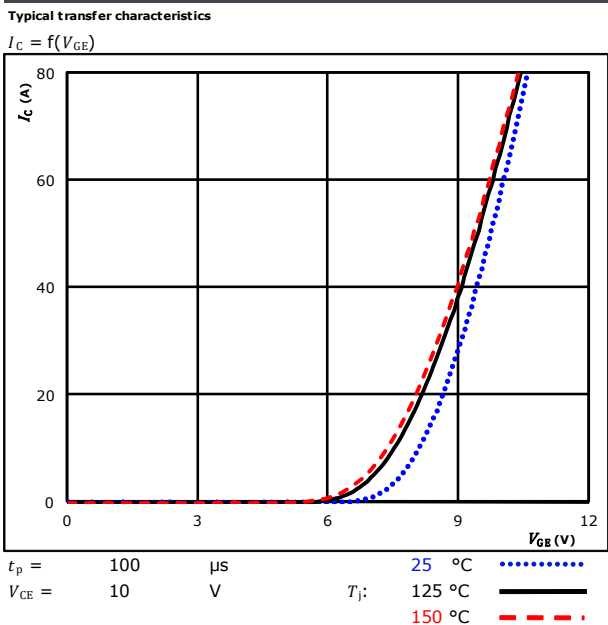
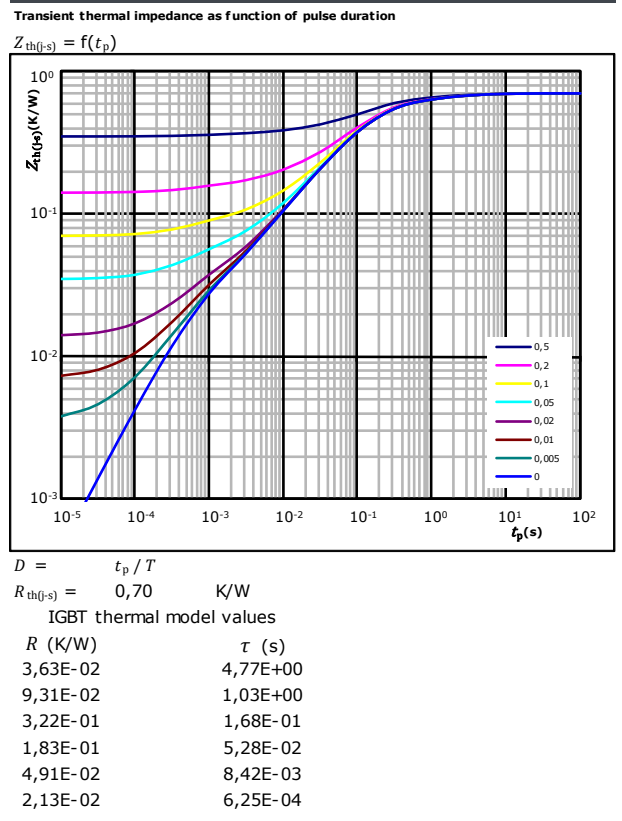

figure 4. IGBT





Inverter Switch Characteristics

figure 5. IGBT

Safe operating area

$$I_C = f(V_{CE})$$

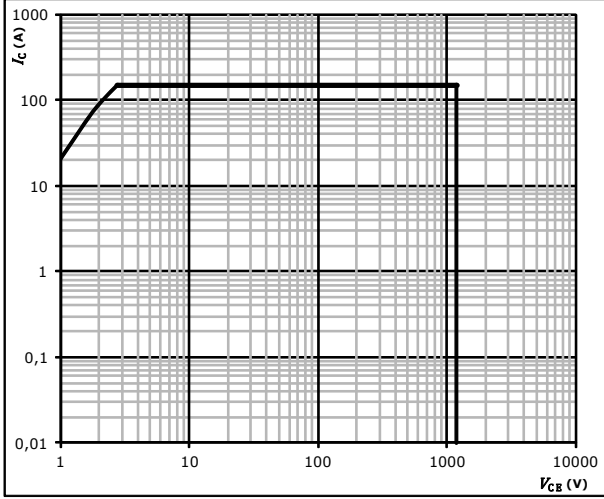

- $D =$ single pulse
- $T_s =$ 80 °C
- $V_{GE} =$ ±15 V
- $T_j = T_{max}$



Inverter Diode Characteristics

figure 1. **FWD**

Typical forward characteristics

$$I_F = f(V_F)$$

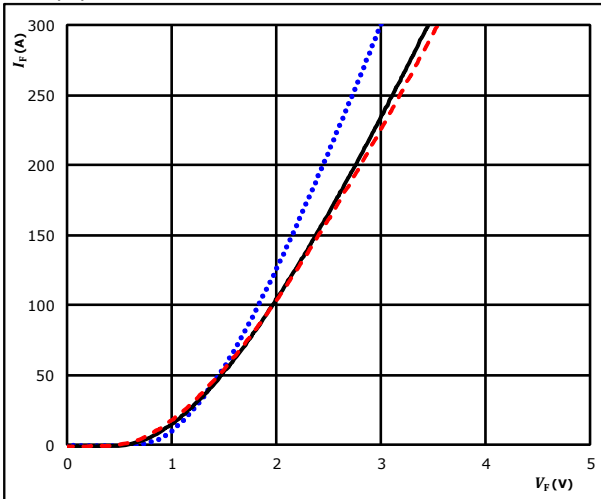

$t_p = 250 \mu s$ T_j : 25 °C (blue dotted line)
 125 °C (black solid line)
 150 °C (red dashed line)

figure 2. **FWD**

Transient thermal impedance as a function of pulse width

$$Z_{th(j-s)} = f(t_p)$$

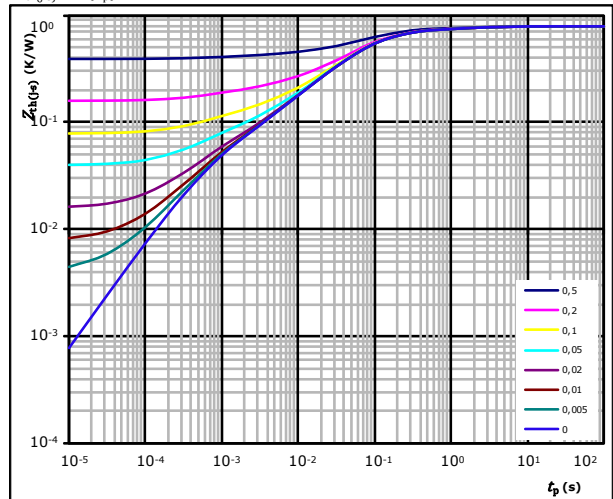

$D = t_p / T$
 $R_{th(j-s)} = 0,79 \text{ K/W}$
 FWD thermal model values

R (K/W)	τ (s)
4,05E-02	3,25E+00
9,02E-02	5,38E-01
3,71E-01	8,95E-02
1,97E-01	3,04E-02
5,23E-02	4,59E-03
3,58E-02	6,26E-04

Thermistor Characteristics

figure 1. **Thermistor**

Typical NTC characteristic
 as a function of temperature

$$R = f(T)$$

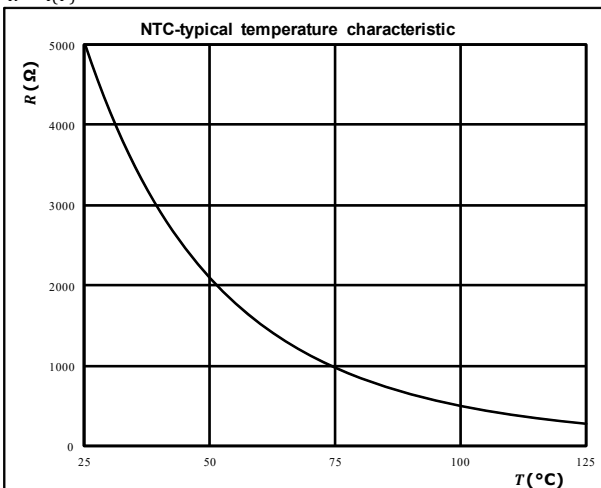



Inverter Switching Characteristics

figure 1. IGBT

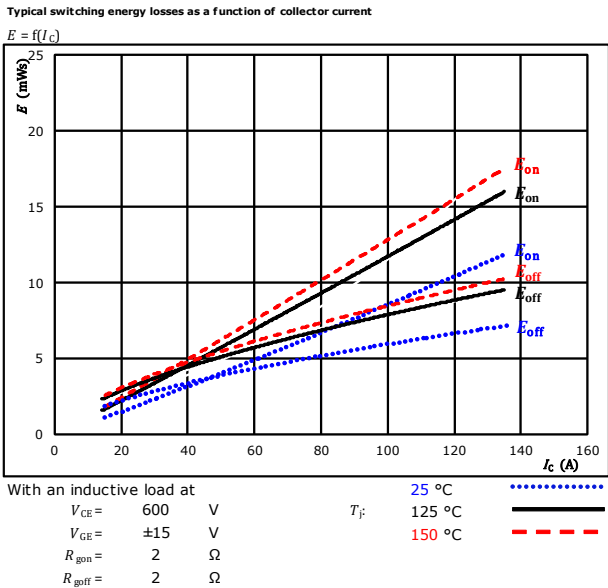

figure 2. IGBT

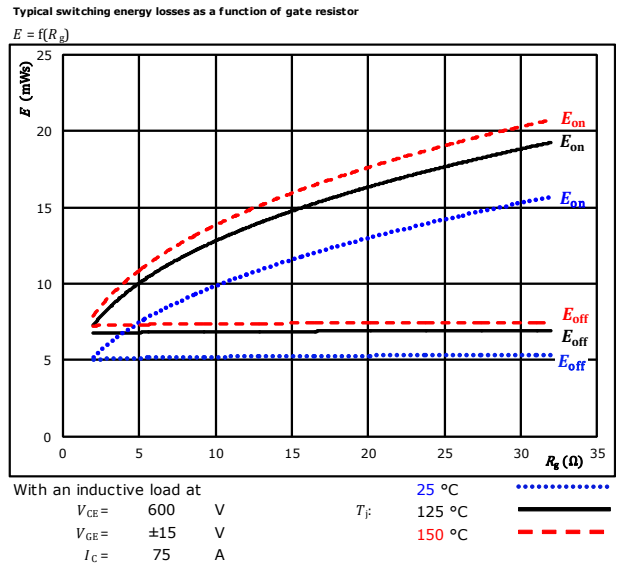

figure 3. FWD

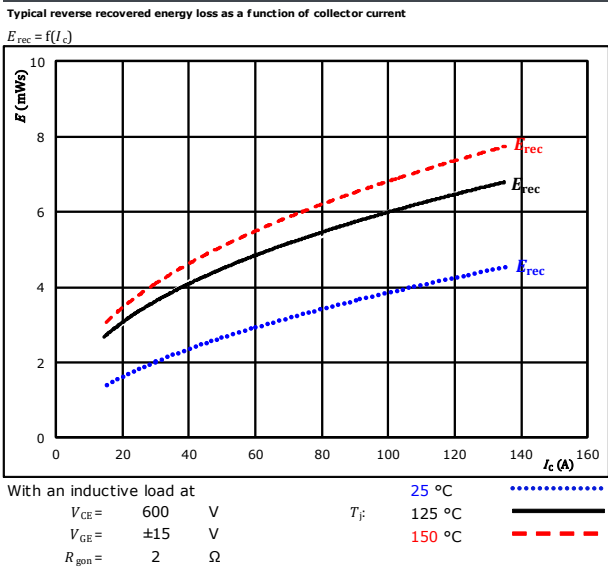
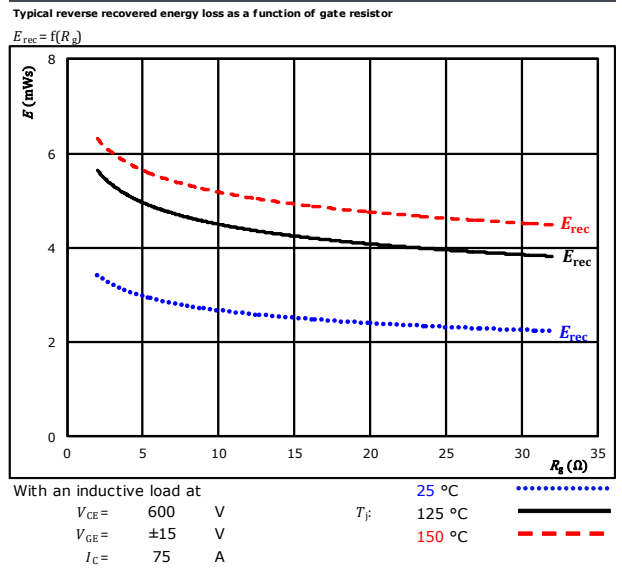

figure 4. FWD





Inverter Switching Characteristics

figure 5. IGBT

Typical switching times as a function of collector current

$$t = f(I_C)$$

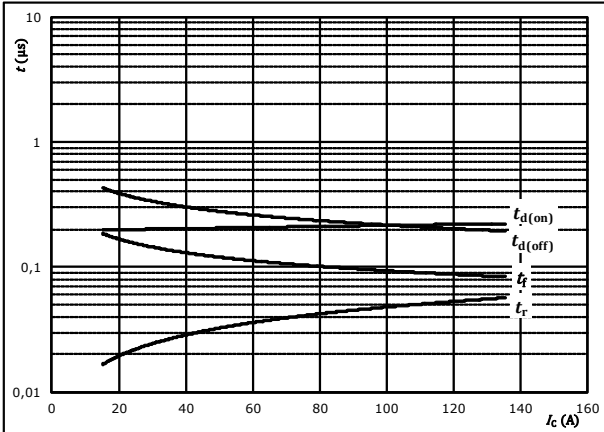

With an inductive load at

$T_j =$	150	°C
$V_{CE} =$	600	V
$V_{GE} =$	±15	V
$R_{g(on)} =$	2	Ω
$R_{g(off)} =$	2	Ω

figure 6. IGBT

Typical switching times as a function of gate resistor

$$t = f(R_g)$$

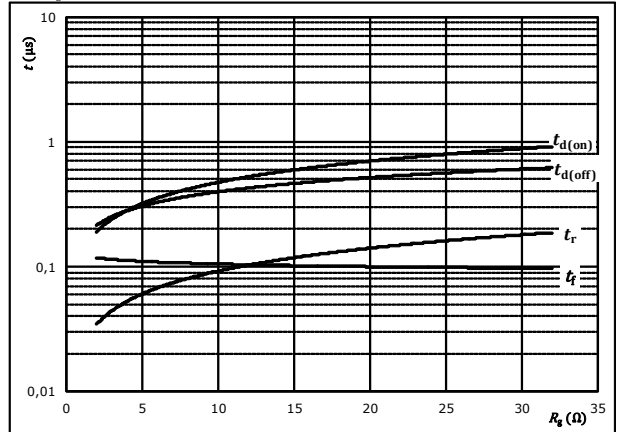

With an inductive load at

$T_j =$	150	°C
$V_{CE} =$	600	V
$V_{GE} =$	±15	V
$I_C =$	75	A

figure 7. FWD

Typical reverse recovery time as a function of collector current

$$t_{rr} = f(I_C)$$

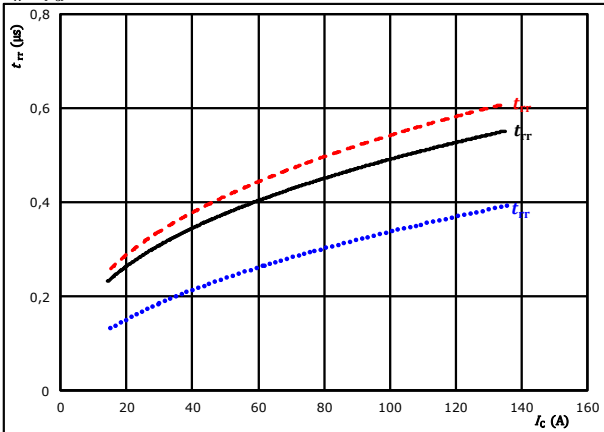

At	$V_{CE} =$	600	V	$T_j:$	25 °C
	$V_{GE} =$	±15	V		125 °C	————
	$R_{g(on)} =$	2	Ω		150 °C	-----

figure 8. FWD

Typical reverse recovery time as a function of IGBT turn on gate resistor

$$t_{rr} = f(R_{g(on)})$$

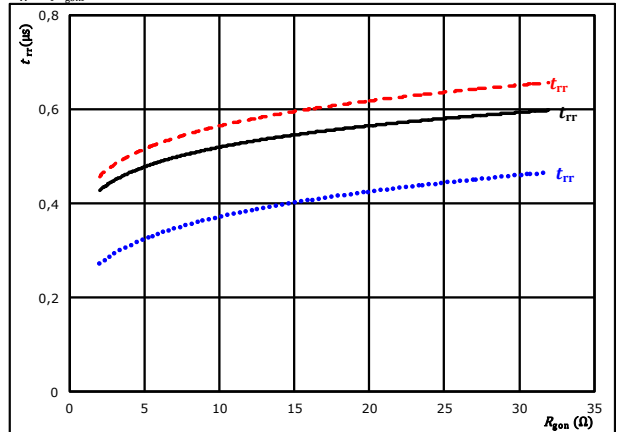

At	$V_{CE} =$	600	V	$T_j:$	25 °C
	$V_{GE} =$	±15	V		125 °C	————
	$I_C =$	75	A		150 °C	-----



Inverter Switching Characteristics

figure 9. FWD

Typical recovered charge as a function of collector current

$$Q_r = f(I_c)$$

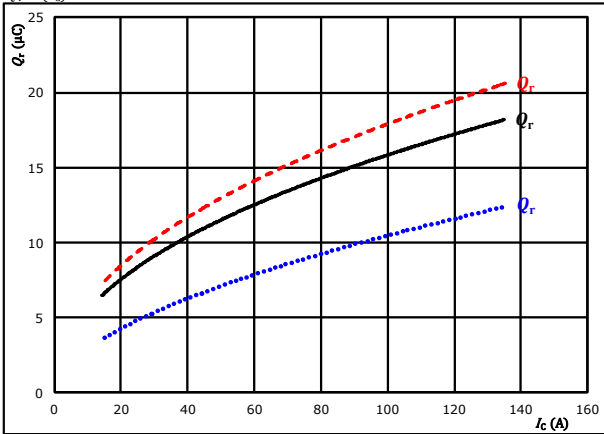

At $V_{CE} = 600$ V $T_j = 25$ °C
 $V_{GE} = \pm 15$ V $T_j = 125$ °C ———
 $R_{gon} = 2$ Ω $T_j = 150$ °C - - - - -

figure 10. FWD

Typical recovered charge as a function of IGBT turn on gate resistor

$$Q_r = f(R_{gon})$$

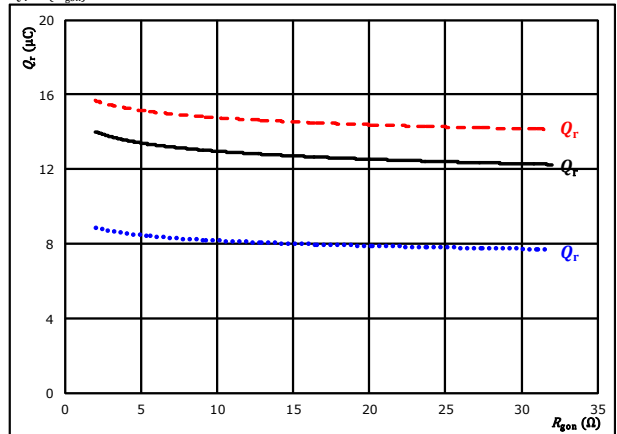

At $V_{CE} = 600$ V $T_j = 25$ °C
 $V_{GE} = \pm 15$ V $T_j = 125$ °C ———
 $I_c = 75$ A $T_j = 150$ °C - - - - -

figure 11. FWD

Typical peak reverse recovery current current as a function of collector current

$$I_{RM} = f(I_c)$$

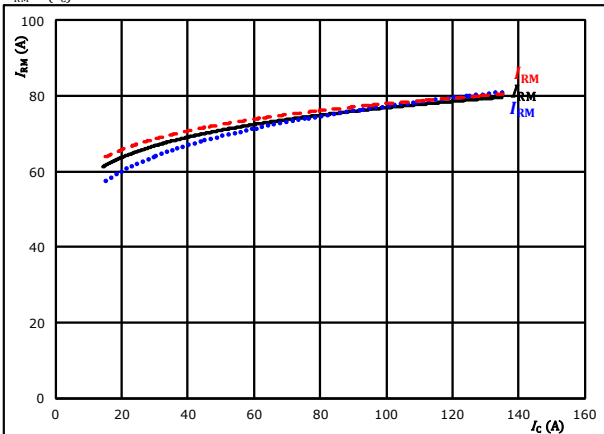

At $V_{CE} = 600$ V $T_j = 25$ °C
 $V_{GE} = \pm 15$ V $T_j = 125$ °C ———
 $R_{gon} = 2$ Ω $T_j = 150$ °C - - - - -

figure 12. FWD

Typical peak reverse recovery current as a function of IGBT turn on gate resistor

$$I_{RM} = f(R_{gon})$$

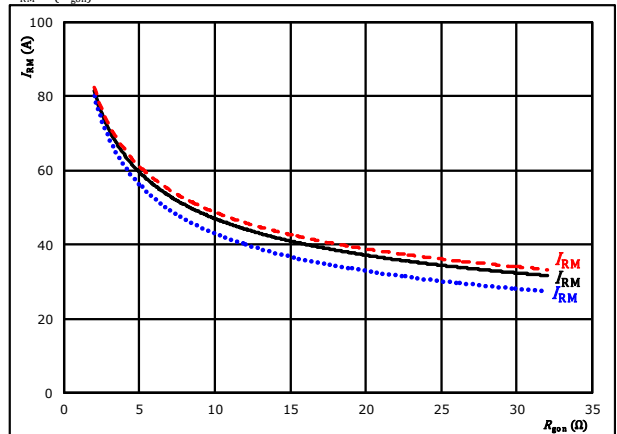

At $V_{CE} = 600$ V $T_j = 25$ °C
 $V_{GE} = \pm 15$ V $T_j = 125$ °C ———
 $I_c = 75$ A $T_j = 150$ °C - - - - -



Inverter Switching Characteristics

figure 13. FWD

Typical rate of fall of forward and reverse recovery current as a function of collector current
 $di_f/dt, di_{rr}/dt = f(I_c)$

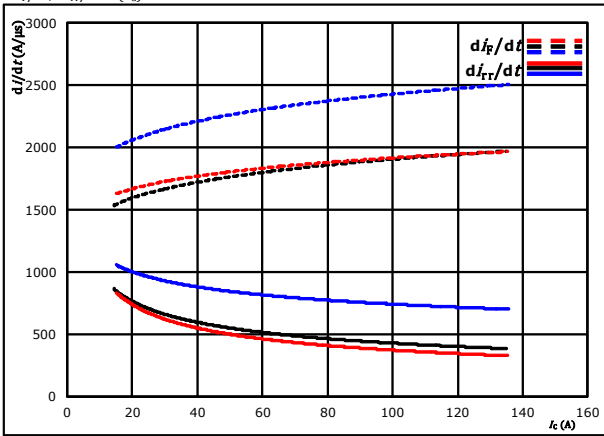

At $V_{CE} = 600$ V $T_j = 25$ °C
 $V_{GE} = \pm 15$ V $T_j = 125$ °C
 $R_{gon} = 2$ Ω $T_j = 150$ °C

figure 14. FWD

Typical rate of fall of forward and reverse recovery current as a function of IGBT turn on gate resistor
 $di_f/dt, di_{rr}/dt = f(R_{gon})$

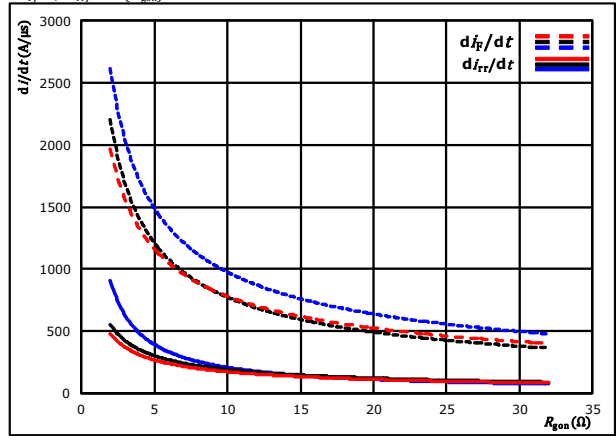

At $V_{CE} = 600$ V $T_j = 25$ °C
 $V_{GE} = \pm 15$ V $T_j = 125$ °C
 $I_c = 75$ A $T_j = 150$ °C

figure 15. IGBT

Reverse bias safe operating area
 $I_c = f(V_{CB})$

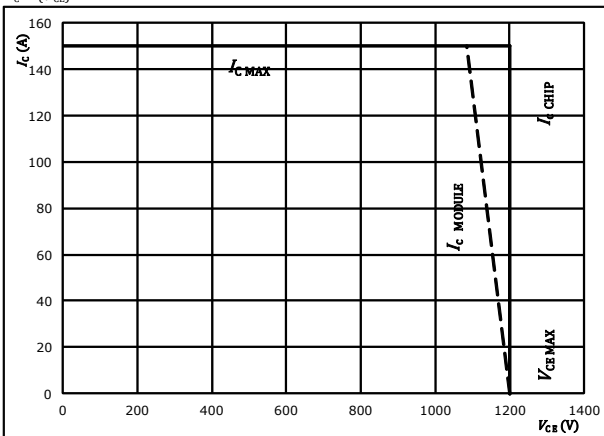

At $T_j = 125$ °C
 $R_{gon} = 2$ Ω
 $R_{goff} = 2$ Ω



Inverter Switching Definitions

General conditions

T_j	=	125 °C
R_{gon}	=	2 Ω
R_{goff}	=	2 Ω

figure 1. IGBT

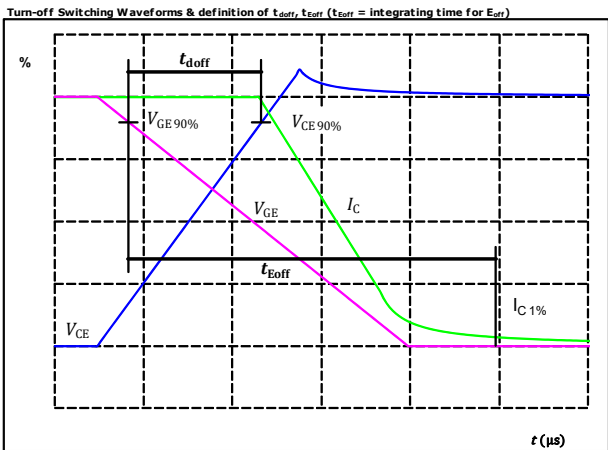

$V_{CE}(0\%) =$	-15	V
$V_{GE}(100\%) =$	15	V
$V_C(100\%) =$	600	V
$I_C(100\%) =$	75	A
$t_{doff} =$	233	ns

figure 2. IGBT

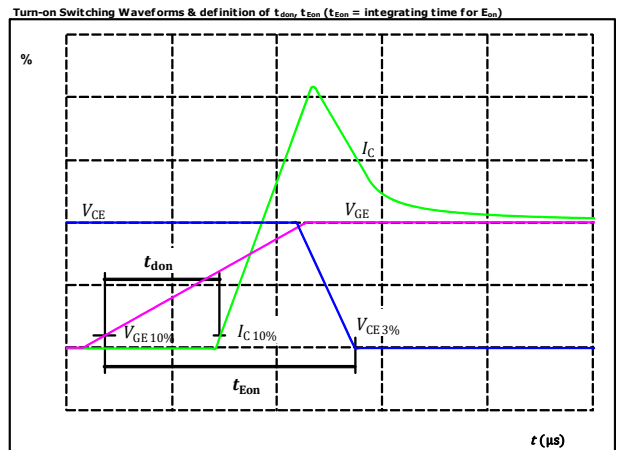

$V_{CE}(0\%) =$	-15	V
$V_{GE}(100\%) =$	15	V
$V_C(100\%) =$	600	V
$I_C(100\%) =$	75	A
$t_{don} =$	208	ns

figure 3. IGBT

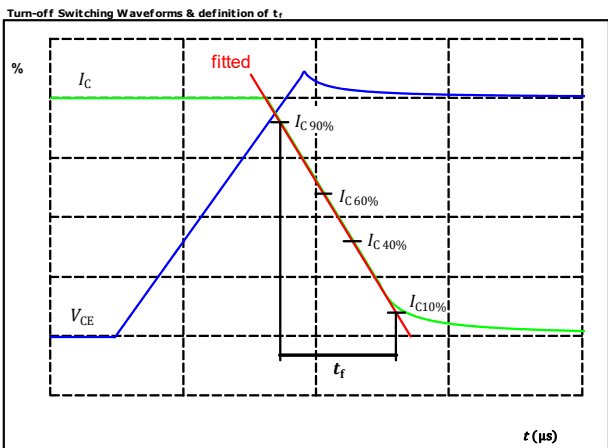

$V_C(100\%) =$	600	V
$I_C(100\%) =$	75	A
$t_f =$	113	ns

figure 4. IGBT

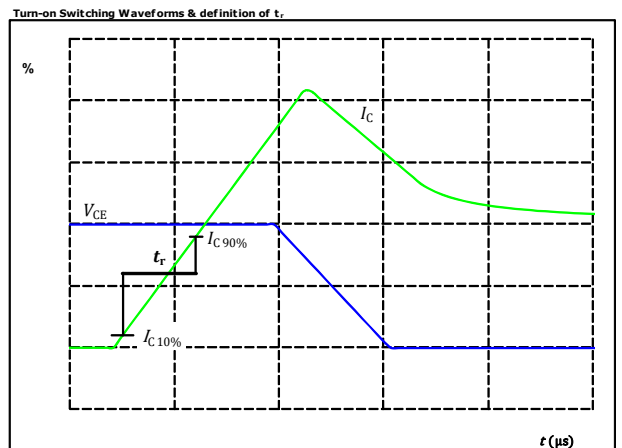

$V_C(100\%) =$	600	V
$I_C(100\%) =$	75	A
$t_r =$	38	ns



Vincotech

10-EY126PA075M7-L197F78T
10-E2126PA075M7-L197F78Z
 datasheet

Inverter Switching Characteristics

figure 5. FWD

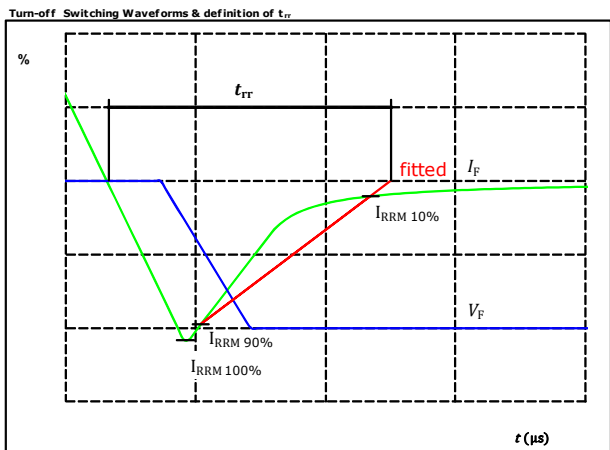

$V_F(100\%) =$	600	V
$I_F(100\%) =$	75	A
$I_{RRM}(100\%) =$	77	A
$t_{rr} =$	432	ns

figure 6. FWD

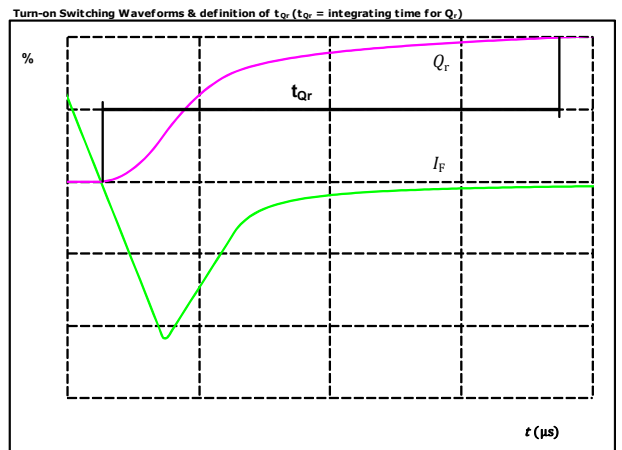

$I_F(100\%) =$	75	A
$Q_r(100\%) =$	13,39	μC



10-EY126PA075M7-L197F78T
10-E2126PA075M7-L197F78Z
 datasheet

Vincotech

Ordering Code & Marking								
Version			Ordering Code					
without thermal paste 12 mm housing with Press-fit pins			10-EY126PA075M7-L197F78T					
without thermal paste 12 mm housing with solder pins			10-E2126PA075M7-L197F78Z					
with thermal paste 12 mm housing with Press-fit pins			10-EY126PA075M7-L197F78T-/3/					
with thermal paste 12 mm housing with solder pins			10-E2126PA075M7-L197F78Z -/3/					
NN-NNNNNNNNNNNN TTTTWW WWYY UL VIN LLLLL SSSS			Text	Name	Date code	UL & VIN	Lot	Serial
				NN-NNNNNNNNNNNN-TTTTWW	WWYY	UL VIN	LLLLL	SSSS
			Datamatrix	Type&Ver	Lot number	Serial	Date code	
			TTTTTWW	LLLLL	SSSS	WWYY		

Pin table				Outline	
Pin	X	Y	Function		
1	32	3,2	G16	L197F78T	
2	32	0	Ph3		
3	28,8	0	Ph3		
4	25,6	0	Ph3		
5	19,2	0	Ph2		
6	16	0	Ph2		
7	12,8	0	Ph2		
8	12,8	3,2	G14		
9	6,4	0	Ph1		
10	3,2	0	Ph1		
11	0	0	Ph1		
12	0	3,2	G12		
13	0	19,2	Therm1		
14	0	28,8	Therm2		
15	0	44,8	G11		
16	0	48	DC-1		
17	3,2	48	DC-1		
18	6,4	48	DC-1		
19	9,6	48	DC-1		
20	12,8	48	DC-2		
21	12,8	44,8	G13		
22	16	48	DC-2		
23	19,2	48	DC-2		
24	22,4	48	DC-2		
25	22,4	44,8	G15		
26	25,6	48	DC-3		
27	28,8	48	DC-3		
28	32	48	DC-3		
29	32	44,8	DC-3		
30	12,8	25,6	DC+		
31	12,8	22,4	DC+		
32	12,8	19,2	DC+		
33	12,8	16	DC+		

Tolerance of positions: ±0.05mm at the end of pins
 Dimension of coordinate axis is only offset without tolerance



Vincotech

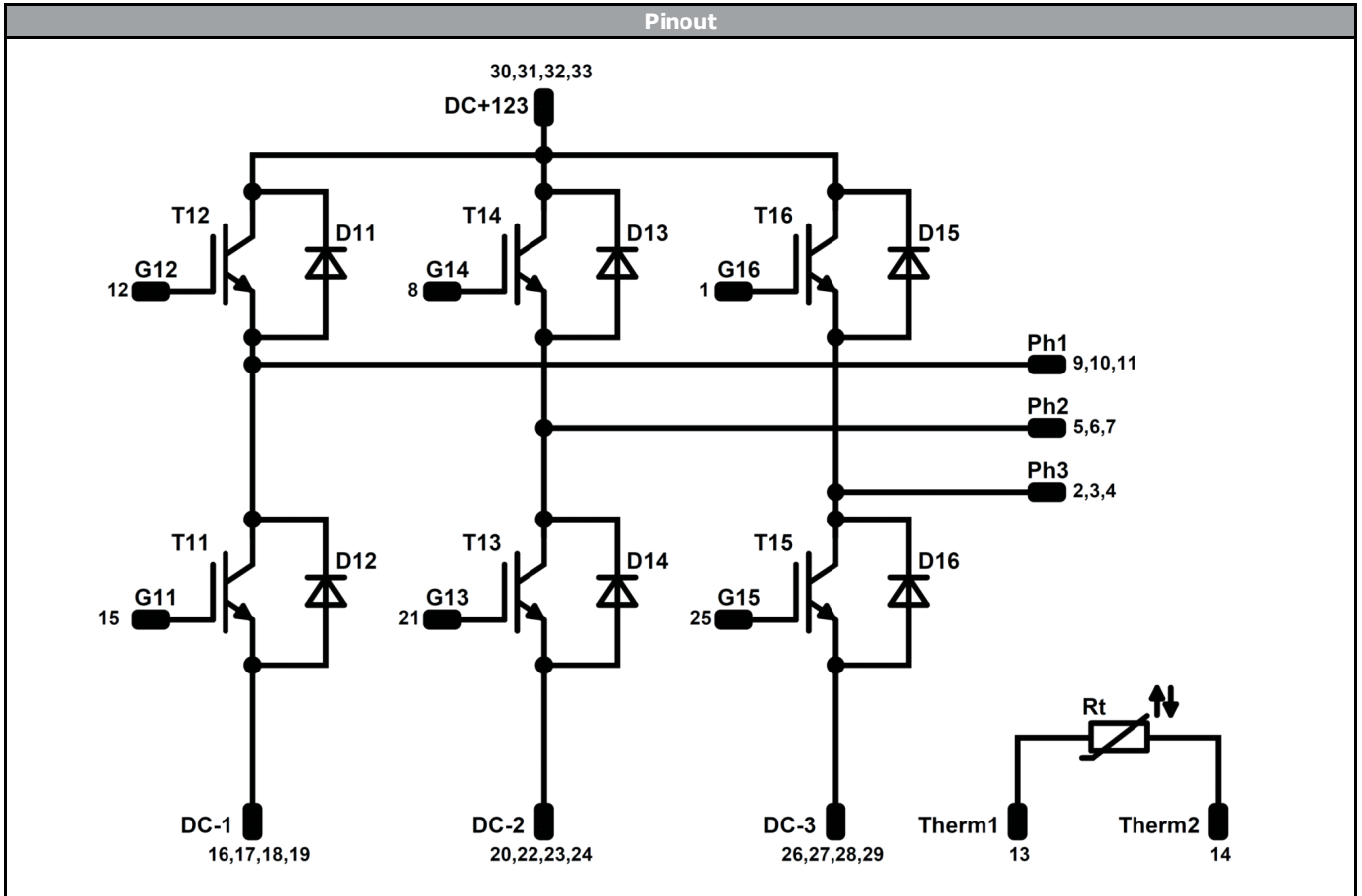

Identification					
ID	Component	Voltage	Current	Function	Comment
T11, T12, T13, T14, T15, T16	IGBT	1200 V	75 A	Inverter Switch	
D11, D12, D13, D14, D15, D16	FWD	1200 V	100 A	Inverter Diode	
Rt	NTC			Thermistor	



Vincotech

Packaging instruction			
Standard packaging quantity (SPQ) 100	>SPQ	Standard	<SPQ Sample

Handling instruction
Handling instructions for <i>flow</i> E2 packages see vincotech.com website.

Package data
Package data for <i>flow</i> E2 packages see vincotech.com website.

UL recognition and file number
This device is certified according to UL 1557 standard, UL file number E192116. For more information see vincotech.com website. 

Document No.:	Date:	Modification:	Pages
10-Ex126PA075M7-L197F78x-D3-14	05 Sep. 2018	Solder pin version added, Cr&Cl	1, 2, 14

DISCLAIMER

The information, specifications, procedures, methods and recommendations herein (together "information") are presented by Vincotech to reader in good faith, are believed to be accurate and reliable, but may well be incomplete and/or not applicable to all conditions or situations that may exist or occur. Vincotech reserves the right to make any changes without further notice to any products to improve reliability, function or design. No representation, guarantee or warranty is made to reader as to the accuracy, reliability or completeness of said information or that the application or use of any of the same will avoid hazards, accidents, losses, damages or injury of any kind to persons or property or that the same will not infringe third parties rights or give desired results. It is reader's sole responsibility to test and determine the suitability of the information and the product for reader's intended use.

LIFE SUPPORT POLICY

Vincotech products are not authorised for use as critical components in life support devices or systems without the express written approval of Vincotech.

As used herein:

1. Life support devices or systems are devices or systems which, (a) are intended for surgical implant into the body, or (b) support or sustain life, or (c) whose failure to perform when properly used in accordance with instructions for use provided in labelling can be reasonably expected to result in significant injury to the user.
2. A critical component is any component of a life support device or system whose failure to perform can be reasonably expected to cause the failure of the life support device or system, or to affect its safety or effectiveness.