



flowPACK 0B

1200 V / 8 A

Features

- IGBT4 (1200 V) technology
- Open emitter topology
- New ultra-compact housing
- Single-screw heat sink mounting

Target applications

- Industrial Drives
- Embedded Drives

Types

- 10-OB126PA008SC-M998F09

flow 0B 17 mm housing

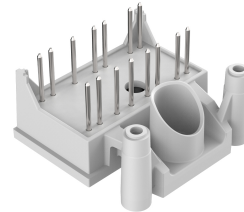

Schematic

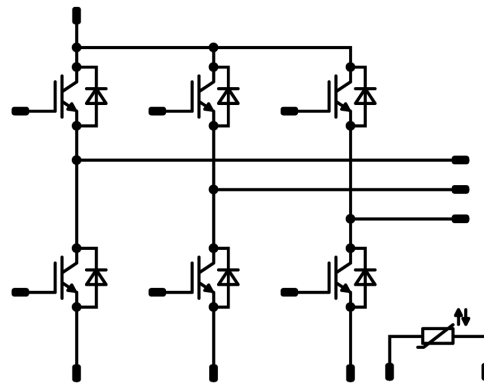



Vincotech

Maximum Ratings

$T_j = 25\text{ °C}$, unless otherwise specified

Parameter	Symbol	Conditions	Value	Unit
Inverter Switch				
Collector-emitter voltage	V_{CES}		1200	V
Collector current (DC current)	I_C	$T_j = T_{jmax}$ $T_s = 80\text{ °C}$	15	A
Repetitive peak collector current	I_{CRM}	t_p limited by T_{jmax}	24	A
Total power dissipation	P_{tot}	$T_j = T_{jmax}$ $T_s = 80\text{ °C}$	54	W
Gate-emitter voltage	V_{GES}		± 20	V
Short circuit ratings	t_{SC}	$V_{GE} = 15\text{ V}$, $V_{CC} = 800\text{ V}$ $T_j = 150\text{ °C}$	10	μs
Maximum junction temperature	T_{jmax}		175	$^{\circ}\text{C}$

Inverter Diode

Peak repetitive reverse voltage	V_{RRM}		1200	V
Forward current (DC current)	I_F	$T_j = T_{jmax}$ $T_s = 80\text{ °C}$	19	A
Repetitive peak forward current	I_{FRM}	t_p limited by T_{jmax}	20	A
Total power dissipation	P_{tot}	$T_j = T_{jmax}$ $T_s = 80\text{ °C}$	44	W
Maximum junction temperature	T_{jmax}		175	$^{\circ}\text{C}$

Module Properties

Thermal Properties

Storage temperature	T_{stg}		-40...+125	$^{\circ}\text{C}$
Operation temperature under switching condition	T_{jop}		-40...+($T_{jmax} - 25$)	$^{\circ}\text{C}$

Isolation Properties

Isolation voltage	V_{isol}	DC Test Voltage* $t_p = 2\text{ s}$	6000	V
Isolation voltage	V'_{isol}	AC Voltage $t_p = 1\text{ min}$	2500	V
Creepage distance			min. 12,7	mm
Clearance			min. 12,7	mm
Comparative Tracking Index	CTI		> 200	

*100 % tested in production



Vincotech

Characteristic Values

Parameter	Symbol	Conditions					Values			Unit
		V_{GE} [V] V_{GS} [V]	V_{CE} [V] V_{DS} [V] V_F [V]	I_C [A] I_D [A] I_F [A]	T_j [°C]	Min	Typ	Max		

Inverter Switch

Static

Gate-emitter threshold voltage	$V_{GE(th)}$	$V_{CE} = V_{GE}$			0,00015	25	5,3	5,8	6,3	V
Collector-emitter saturation voltage	$V_{CE(sat)}$		15		8	25 150	1,58	1,86 2,24	2,07 ⁽¹⁾	V
Collector-emitter cut-off current	I_{CES}		0	1200		25			1	μA
Gate-emitter leakage current	I_{GES}		20	0		25			120	nA
Internal gate resistance	r_g							None		Ω
Input capacitance	C_{ies}	$f = 1 \text{ Mhz}$	0	25		25		490		pF
Reverse transfer capacitance	C_{res}							30		pF
Gate charge	Q_g	$V_{CC} = 960 \text{ V}$	15		8	25		53		nC

Thermal

Thermal resistance junction to sink ⁽²⁾	$R_{th(j-s)}$	$\lambda_{paste} = 3,4 \text{ W/mK}$ (PSX)						1,75		K/W
--	---------------	---	--	--	--	--	--	------	--	-----

Dynamic

Turn-on delay time	$t_{d(on)}$	$R_{gon} = 32 \Omega$ $R_{goff} = 32 \Omega$	± 15	600	8	25		63,36		ns
Rise time	t_r					125		62,4	ns	
						150		62,08		
Turn-off delay time	$t_{d(off)}$					25		176,64	ns	
						125		240,64		
150						256				
Fall time	t_f					25		104,37	ns	
		125		166,9						
150		184,72								
Turn-on energy (per pulse)	E_{on}	$Q_{tFWD} = 0,701 \mu\text{C}$			25		0,442	mWs		
		$Q_{tFWD} = 1,37 \mu\text{C}$			125		0,703			
		$Q_{tFWD} = 1,58 \mu\text{C}$			150		0,779			
Turn-off energy (per pulse)	E_{off}				25		0,487	mWs		
					125		0,793			
					150		0,882			



Vincotech

10-0B126PA008SC-M998F09
datasheet

Characteristic Values

Parameter	Symbol	Conditions					Values			Unit
		V_{GE} [V] V_{GS} [V]	V_{CE} [V] V_{DS} [V] V_F [V]	I_C [A] I_D [A] I_F [A]	T_j [°C]	Min	Typ	Max		
Inverter Diode										
Static										
Forward voltage	V_F				10	25 125 150	1,35	1,79 1,77 1,73	2,05 ⁽¹⁾	V
Reverse leakage current	I_R	$V_i = 1200$ V				25			2,7	μA
Thermal										
Thermal resistance junction to sink ⁽²⁾	$R_{th(j-s)}$	$\lambda_{paste} = 3,4$ W/mK (PSX)						2,16		K/W
Dynamic										
Peak recovery current	I_{RRM}					25 125 150		7,36 8,88 9,17		A
Reverse recovery time	t_{rr}					25 125 150		245,14 388,16 428,58		ns
Recovered charge	Q_r	$di/dt=333$ A/μs $di/dt=318$ A/μs $di/dt=309$ A/μs	±15	600	8	25 125 150		0,701 1,37 1,58		μC
Reverse recovered energy	E_{rec}					25 125 150		0,278 0,548 0,635		mWs
Peak rate of fall of recovery current	$(di_r/dt)_{max}$					25 125 150		65,95 50,48 46,63		A/μs



Vincotech

Characteristic Values

Parameter	Symbol	Conditions					Values			Unit
		V_{GS} [V]	V_{GE} [V]	V_{DS} [V]	V_{CE} [V]	T_j [°C]	Min	Typ	Max	

Thermistor

Static

Rated resistance	R					25		21,5		kΩ
Deviation of R_{100}	$A_{R/R}$	$R_{100} = 1486 \Omega$				100	-4,5		4,5	%
Power dissipation	P							210		mW
Power dissipation constant	d					25		3,5		mW/K
B-value	$B_{(25/50)}$							3884		K
B-value	$B_{(25/100)}$	Tol. $\pm 1 \%$						3964		K
Vincotech Thermistor Reference									F	

⁽¹⁾ Value at chip level

⁽²⁾ Only valid with pre-applied Vincotech thermal interface material.



Inverter Switch Characteristics

figure 1. IGBT

Typical output characteristics

$$I_C = f(V_{CE})$$

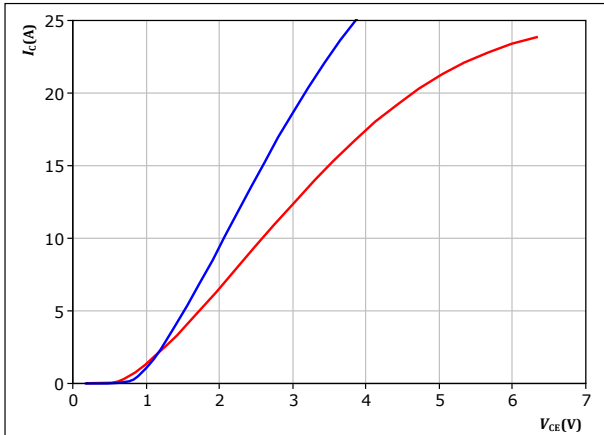

$t_p = 250 \mu\text{s}$
 $V_{GE} = 15 \text{ V}$
 $T_j:$ — 25 °C
— 150 °C

figure 2. IGBT

Typical output characteristics

$$I_C = f(V_{CE})$$

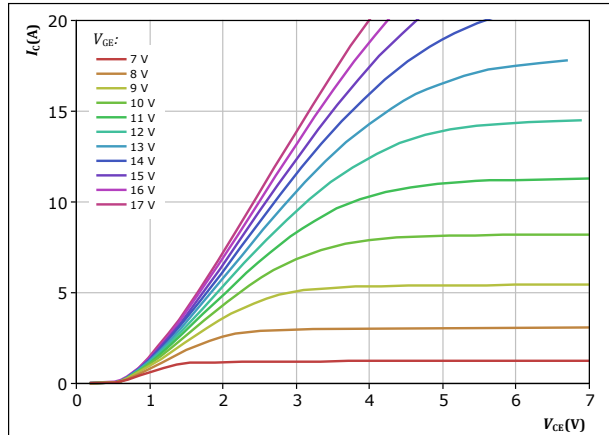

$t_p = 250 \mu\text{s}$
 $T_j = 150 \text{ °C}$
 V_{GE} from 7 V to 17 V in steps of 1 V

figure 3. IGBT

Typical transfer characteristics

$$I_C = f(V_{GE})$$

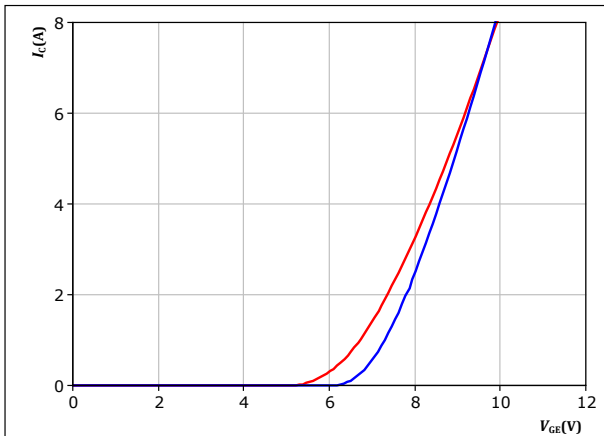

$t_p = 250 \mu\text{s}$
 $V_{CE} = 10 \text{ V}$
 $T_j:$ — 25 °C
— 150 °C

figure 4. IGBT

Transient thermal impedance as a function of pulse width

$$Z_{th(j-s)} = f(t_p)$$

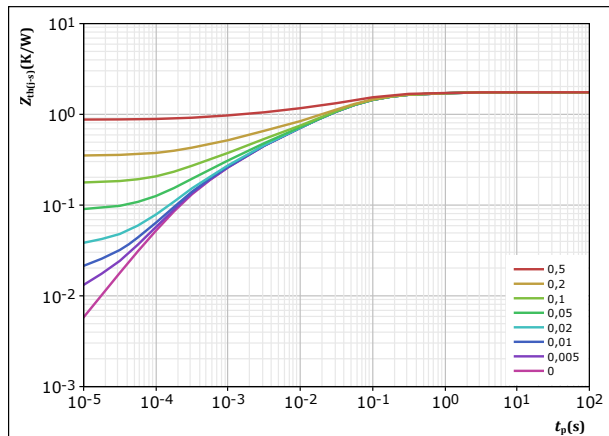

$D = t_p / T$
 $R_{th(j-s)} = 1,749 \text{ K/W}$
IGBT thermal model values

R (K/W)	τ (s)
1,27E-01	8,75E-01
5,68E-01	8,98E-02
6,23E-01	2,27E-02
3,02E-01	2,42E-03
1,29E-01	3,02E-04



Inverter Switch Characteristics

figure 5. IGBT

Safe operating area

$$I_C = f(V_{CE})$$

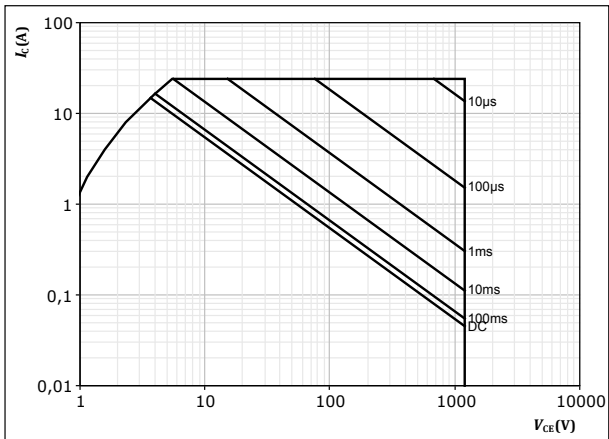

$D =$ single pulse
 $T_s = 80 \text{ } ^\circ\text{C}$
 $V_{GE} = 15 \text{ V}$
 $T_j = T_{jmax}$



Inverter Diode Characteristics

figure 6. FWD

Typical forward characteristics

$$I_F = f(V_F)$$

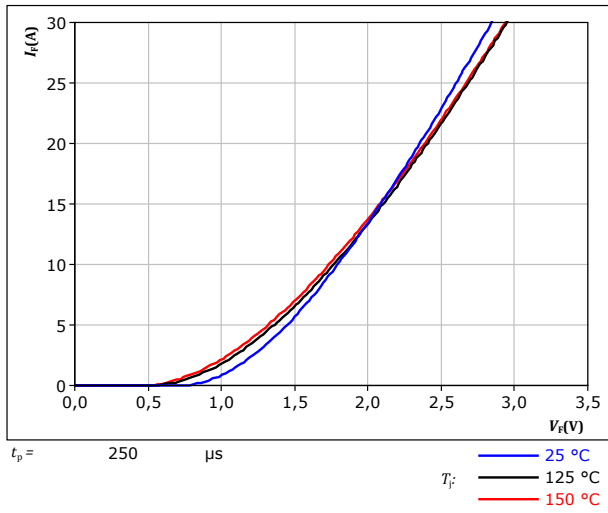
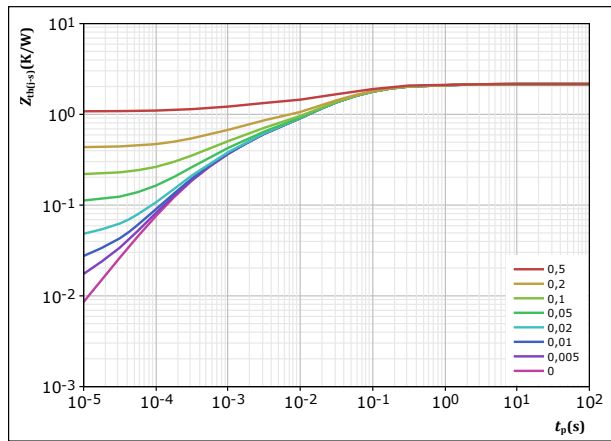

figure 7. FWD

Transient thermal impedance as a function of pulse width

$$Z_{th(j-s)} = f(t_p)$$



$D = \frac{t_p}{T}$
 $R_{th(j-s)} = 2,158 \text{ K/W}$
 FWD thermal model values

R (K/W)	τ (s)
1,52E-01	1,19E+00
8,24E-01	8,09E-02
6,97E-01	1,59E-02
3,61E-01	1,33E-03
1,24E-01	2,28E-04



Thermistor Characteristics

figure 8. Thermistor

Typical NTC characteristic as function of temperature

$$R_T = f(T)$$

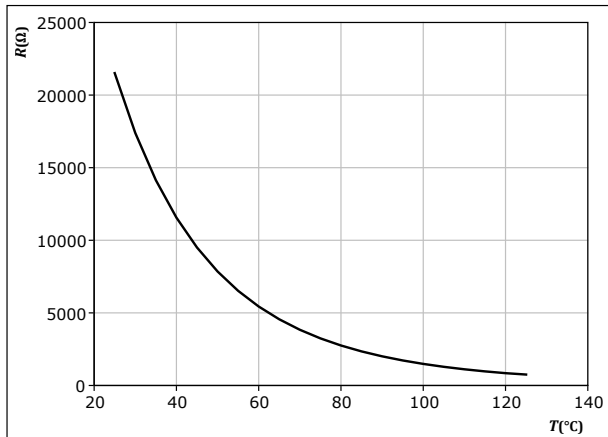



Inverter Switching Characteristics

figure 9. IGBT

Typical switching energy losses as a function of collector current
 $E = f(I_c)$

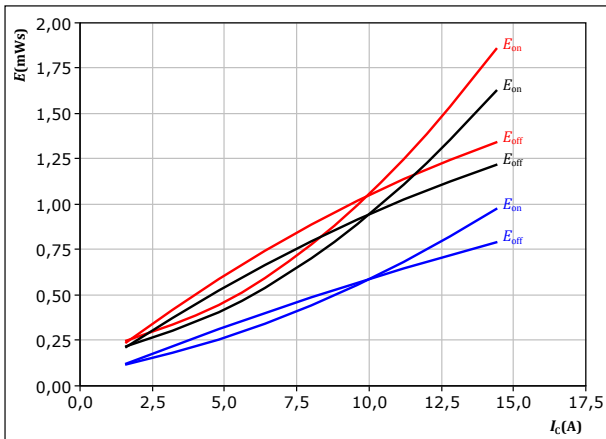

With an inductive load at

$V_{CE} =$	600	V	$T_j:$	— 25 °C
$V_{GE} =$	±15	V		— 125 °C
$R_{gon} =$	32	Ω		— 150 °C
$R_{goff} =$	32	Ω		

figure 10. IGBT

Typical switching energy losses as a function of gate resistor
 $E = f(R_g)$

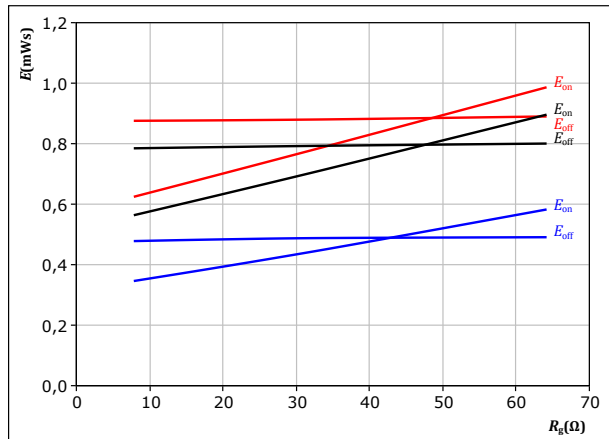

With an inductive load at

$V_{CE} =$	600	V	$T_j:$	— 25 °C
$V_{GE} =$	±15	V		— 125 °C
$I_c =$	8	A		— 150 °C

figure 11. FWD

Typical reverse recovered energy loss as a function of collector current
 $E_{rec} = f(I_c)$

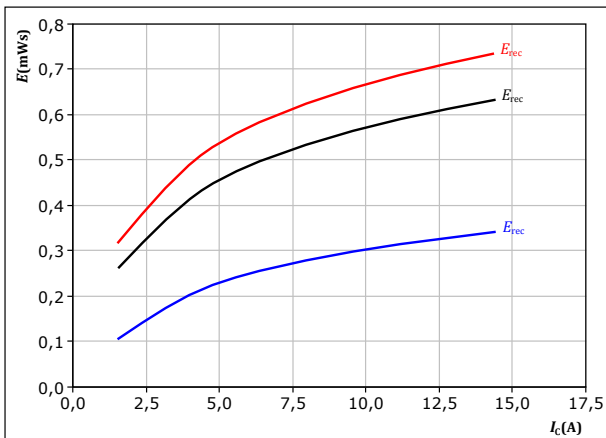

With an inductive load at

$V_{CE} =$	600	V	$T_j:$	— 25 °C
$V_{GE} =$	±15	V		— 125 °C
$R_{gon} =$	32	Ω		— 150 °C

figure 12. FWD

Typical reverse recovered energy loss as a function of gate resistor
 $E_{rec} = f(R_g)$

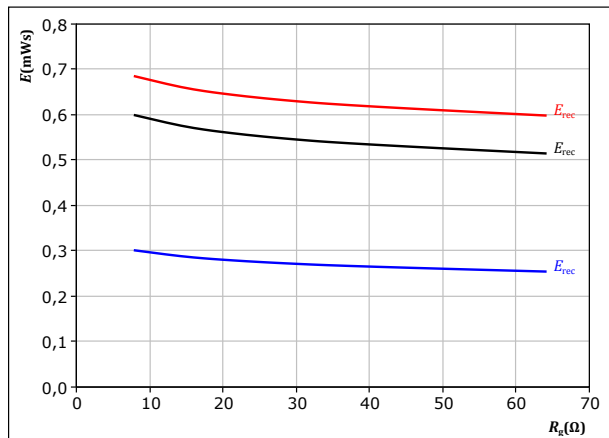

With an inductive load at

$V_{CE} =$	600	V	$T_j:$	— 25 °C
$V_{GE} =$	±15	V		— 125 °C
$I_c =$	8	A		— 150 °C



Inverter Switching Characteristics

figure 13. IGBT

Typical switching times as a function of collector current
 $t = f(I_c)$

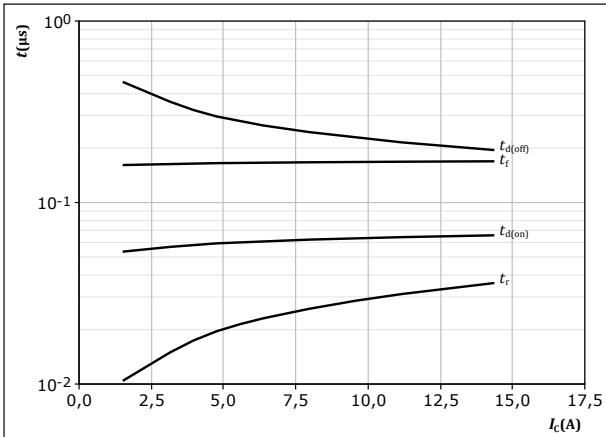

With an inductive load at
 $T_j = 150 \text{ } ^\circ\text{C}$
 $V_{CE} = 600 \text{ V}$
 $V_{GE} = \pm 15 \text{ V}$
 $R_{g(on)} = 32 \text{ } \Omega$
 $R_{g(off)} = 32 \text{ } \Omega$

figure 14. IGBT

Typical switching times as a function of gate resistor
 $t = f(R_g)$

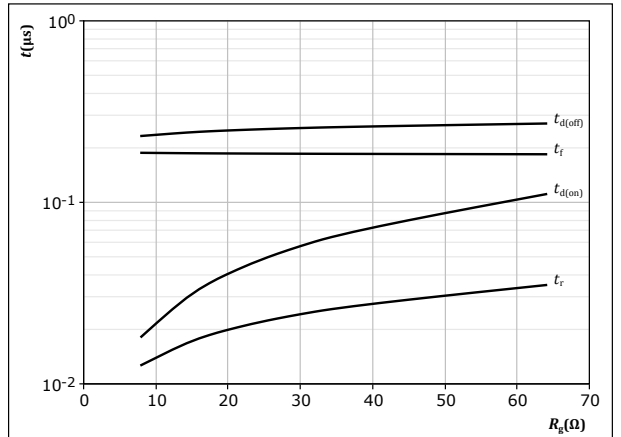

With an inductive load at
 $T_j = 150 \text{ } ^\circ\text{C}$
 $V_{CE} = 600 \text{ V}$
 $V_{GE} = \pm 15 \text{ V}$
 $I_c = 8 \text{ A}$

figure 15. FWD

Typical reverse recovery time as a function of collector current
 $t_{rr} = f(I_c)$

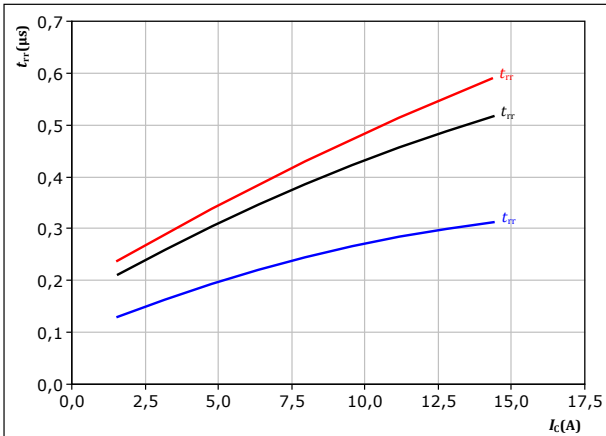

With an inductive load at
 $V_{CE} = 600 \text{ V}$
 $V_{GE} = \pm 15 \text{ V}$
 $R_{g(on)} = 32 \text{ } \Omega$
 $T_j:$ — 25 °C
— 125 °C
— 150 °C

figure 16. FWD

Typical reverse recovery time as a function of IGBT turn off gate resistor
 $t_{rr} = f(R_{g(off)})$

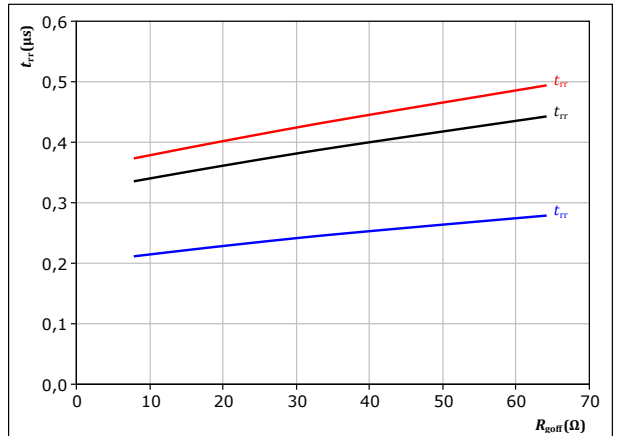

With an inductive load at
 $V_{CE} = 600 \text{ V}$
 $V_{GE} = \pm 15 \text{ V}$
 $I_c = 8 \text{ A}$
 $T_j:$ — 25 °C
— 125 °C
— 150 °C



Inverter Switching Characteristics

figure 17. FWD

Typical recovered charge as a function of collector current

$$Q_r = f(I_c)$$

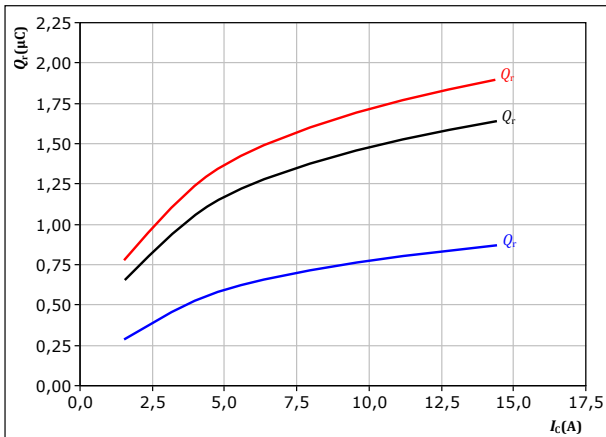

With an inductive load at

$V_{CE} = 600$ V
 $V_{GE} = \pm 15$ V
 $R_{goff} = 32$ Ω
 $T_j: 25$ °C (blue), 125 °C (black), 150 °C (red)

figure 18. FWD

Typical recovered charge as a function of turn off gate resistor

$$Q_r = f(R_{goff})$$

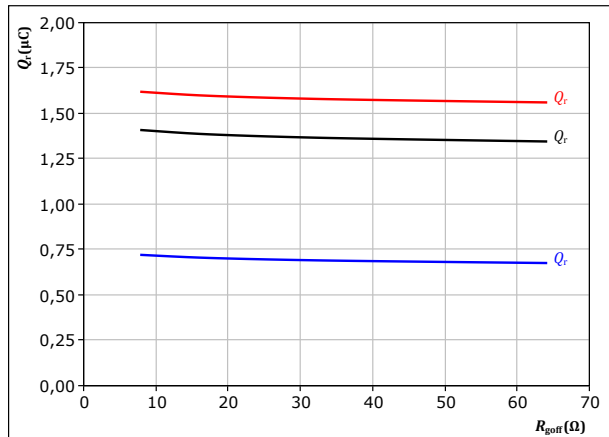

With an inductive load at

$V_{CE} = 600$ V
 $V_{GE} = \pm 15$ V
 $I_c = 8$ A
 $T_j: 25$ °C (blue), 125 °C (black), 150 °C (red)

figure 19. FWD

Typical peak reverse recovery current as a function of collector current

$$I_{RM} = f(I_c)$$

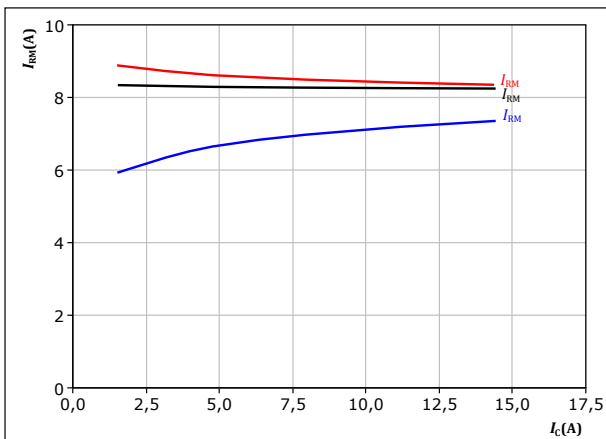

With an inductive load at

$V_{CE} = 600$ V
 $V_{GE} = \pm 15$ V
 $R_{goff} = 32$ Ω
 $T_j: 25$ °C (blue), 125 °C (black), 150 °C (red)

figure 20. FWD

Typical peak reverse recovery current as a function of turn off gate resistor

$$I_{RM} = f(R_{goff})$$

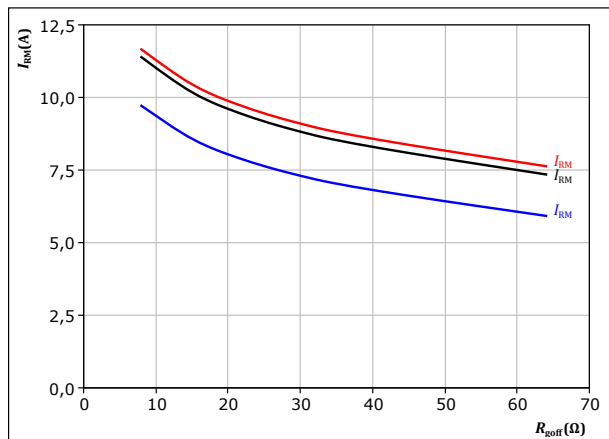

With an inductive load at

$V_{CE} = 600$ V
 $V_{GE} = \pm 15$ V
 $I_c = 8$ A
 $T_j: 25$ °C (blue), 125 °C (black), 150 °C (red)



Inverter Switching Characteristics

figure 21. FWD

Typical rate of fall of forward and reverse recovery current as a function of collector current
 $di_f/dt, di_{rr}/dt = f(I_C)$

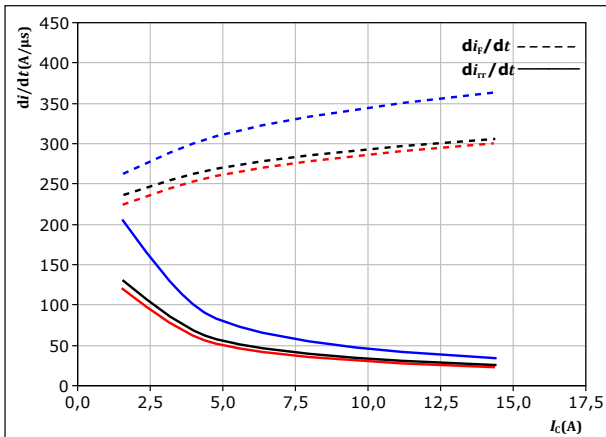

With an inductive load at

$V_{CE} =$	600	V	$T_j =$	25 °C
$V_{GE} =$	±15	V		125 °C
$R_{goff} =$	32	Ω		150 °C

figure 22. FWD

Typical rate of fall of forward and reverse recovery current as a function of turn off gate resistor
 $di_f/dt, di_{rr}/dt = f(R_{goff})$

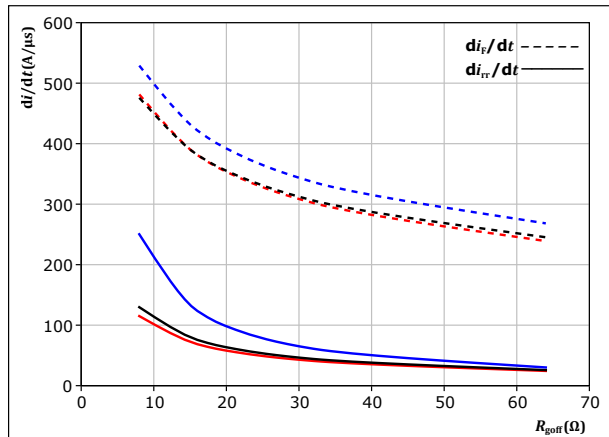

With an inductive load at

$V_{CE} =$	600	V	$T_j =$	25 °C
$V_{GE} =$	±15	V		125 °C
$I_C =$	8	A		150 °C

figure 23. IGBT

Reverse bias safe operating area
 $I_C = f(V_{CE})$

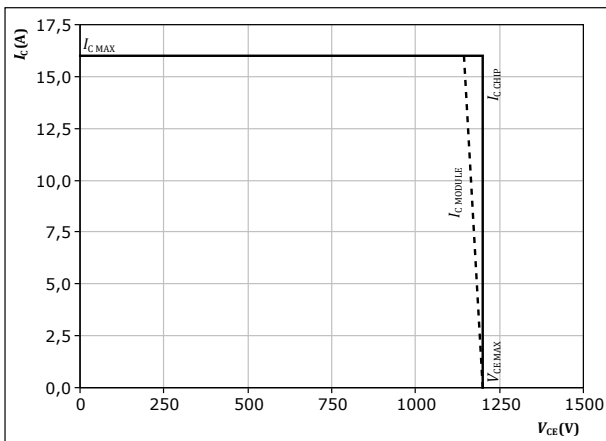

At $T_j = 150$ °C
 $R_{goff} = 32$ Ω
 $R_{gson} = 32$ Ω



Inverter Switching Definitions

figure 24. IGBT
Turn-off Switching Waveforms & definition of t_{doff} , t_{Eoff} (t_{Eoff} = integrating time for E_{off})

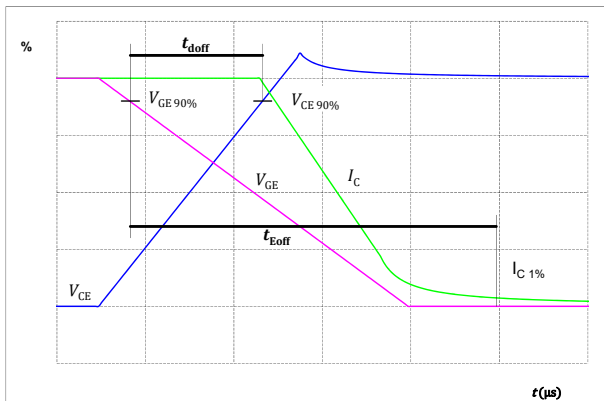

figure 25. IGBT
Turn-on Switching Waveforms & definition of t_{don} , t_{Eon} (t_{Eon} = integrating time for E_{on})

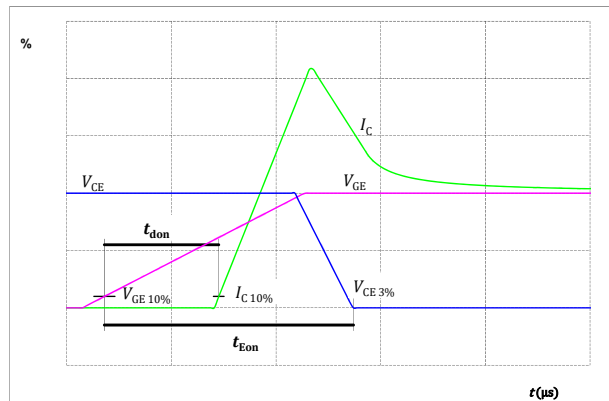

figure 26. IGBT
Turn-off Switching Waveforms & definition of t_f

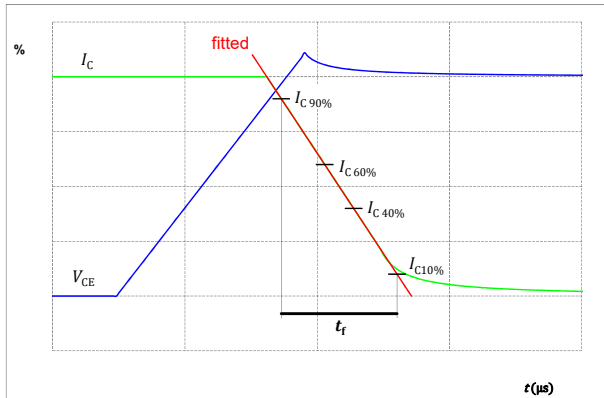
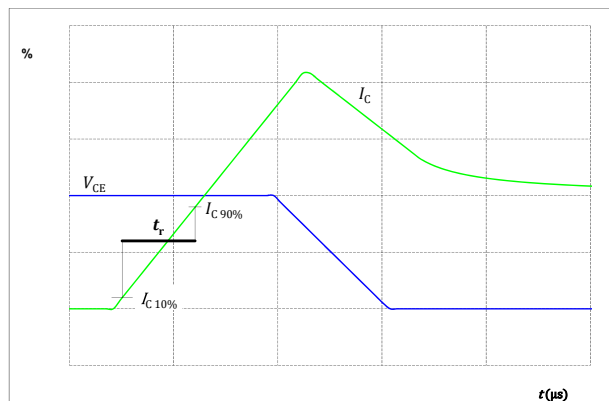

figure 27. IGBT
Turn-on Switching Waveforms & definition of t_r





Inverter Switching Definitions

figure 28. FWD

Turn-off Switching Waveforms & definition of t_{rr}

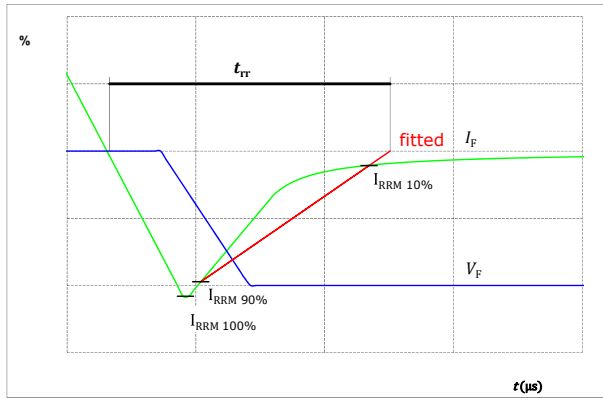
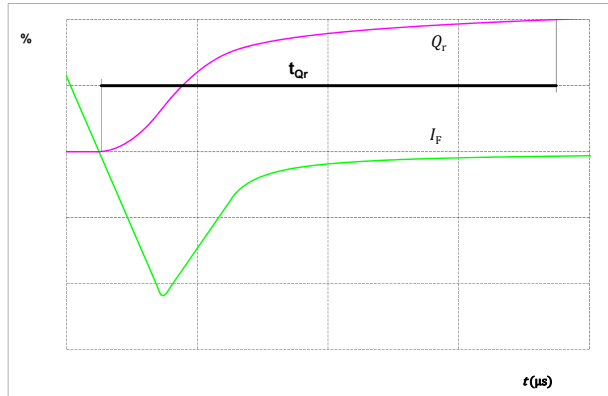

figure 29. FWD

Turn-on Switching Waveforms & definition of t_{Qr} (t_{Qr} = integrating time for Q_r)





Vincotech

10-0B126PA008SC-M998F09
datasheet

Ordering Code	
Version	Ordering Code
Without thermal paste	10-0B126PA008SC-M998F09
With thermal paste (3,4 W/mK, PSX-P7)	10-0B126PA008SC-M998F09-/3/

Marking						
	Text	Name NN-NNNNNNNNNNNNNN- TTTTTVV	VIN & Lot VIN LLLLL	Date code WWYY	Serial SSSS	UL UL
	Datamatrix	Type&Ver TTTTTVV	Lot number LLLLL	Serial SSSS	Date code WWYY	

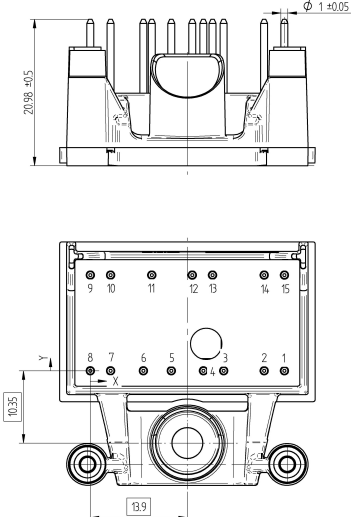
Outline																																																																								
<table border="1"> <thead> <tr> <th colspan="4">Pin table [mm]</th> </tr> <tr> <th>Pin</th> <th>X</th> <th>Y</th> <th>Function</th> </tr> </thead> <tbody> <tr><td>1</td><td>27,8</td><td>0</td><td>G6</td></tr> <tr><td>2</td><td>24,9</td><td>0</td><td>E6</td></tr> <tr><td>3</td><td>19,1</td><td>0</td><td>G5</td></tr> <tr><td>4</td><td>16,2</td><td>0</td><td>E5</td></tr> <tr><td>5</td><td>11,6</td><td>0</td><td>NTC2</td></tr> <tr><td>6</td><td>7,6</td><td>0</td><td>NTC1</td></tr> <tr><td>7</td><td>2,9</td><td>0</td><td>E4</td></tr> <tr><td>8</td><td>0</td><td>0</td><td>G4</td></tr> <tr><td>9</td><td>0</td><td>13,7</td><td>U</td></tr> <tr><td>10</td><td>2,9</td><td>13,7</td><td>G1</td></tr> <tr><td>11</td><td>8,8</td><td>13,7</td><td>DC+</td></tr> <tr><td>12</td><td>14,6</td><td>13,7</td><td>V</td></tr> <tr><td>13</td><td>17,5</td><td>13,7</td><td>G2</td></tr> <tr><td>14</td><td>24,9</td><td>13,7</td><td>G3</td></tr> <tr><td>15</td><td>27,8</td><td>13,7</td><td>W</td></tr> </tbody> </table>					Pin table [mm]				Pin	X	Y	Function	1	27,8	0	G6	2	24,9	0	E6	3	19,1	0	G5	4	16,2	0	E5	5	11,6	0	NTC2	6	7,6	0	NTC1	7	2,9	0	E4	8	0	0	G4	9	0	13,7	U	10	2,9	13,7	G1	11	8,8	13,7	DC+	12	14,6	13,7	V	13	17,5	13,7	G2	14	24,9	13,7	G3	15	27,8	13,7	W
Pin table [mm]																																																																								
Pin	X	Y	Function																																																																					
1	27,8	0	G6																																																																					
2	24,9	0	E6																																																																					
3	19,1	0	G5																																																																					
4	16,2	0	E5																																																																					
5	11,6	0	NTC2																																																																					
6	7,6	0	NTC1																																																																					
7	2,9	0	E4																																																																					
8	0	0	G4																																																																					
9	0	13,7	U																																																																					
10	2,9	13,7	G1																																																																					
11	8,8	13,7	DC+																																																																					
12	14,6	13,7	V																																																																					
13	17,5	13,7	G2																																																																					
14	24,9	13,7	G3																																																																					
15	27,8	13,7	W																																																																					
																																																																								
<p>Tolerance of pinpositions: ±0.5mm at the end of pins Dimension of coordinate axis is only offset without tolerance PCB cutouts and holes see in handling instruction document</p>																																																																								



Vincotech

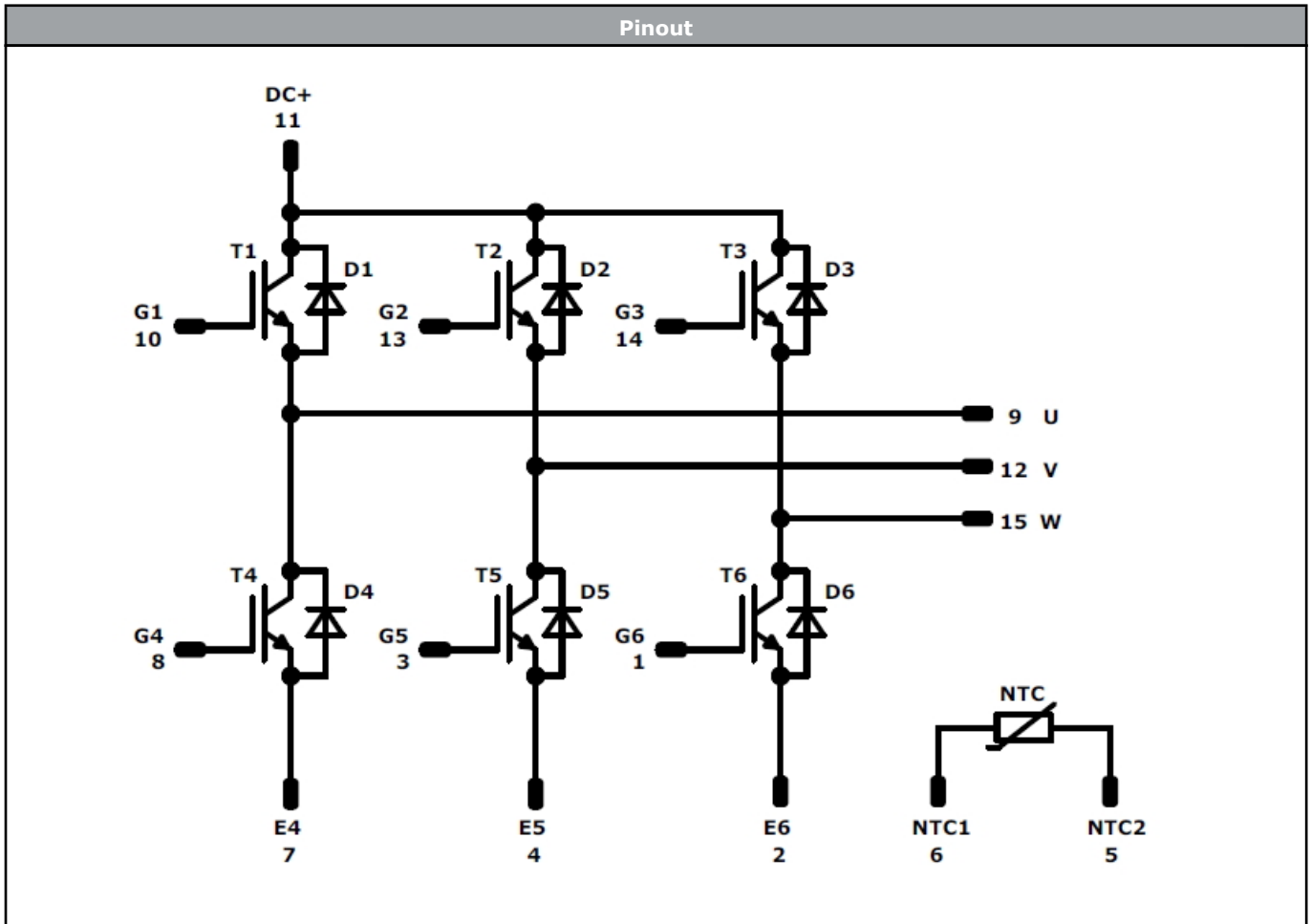

Identification					
ID	Component	Voltage	Current	Function	Comment
T4, T1, T5, T2, T6, T3	IGBT	1200 V	8 A	Inverter Switch	
D1, D4, D2, D5, D3, D6	FWD	1200 V	10 A	Inverter Diode	
NTC	NTC			Thermistor	



Vincotech

Packaging instruction				
Standard packaging quantity (SPQ) 160	>SPQ	Standard	<SPQ	Sample

Handling instruction
Handling instructions for <i>flow</i> 0B packages see vincotech.com website.

Package data
Package data for <i>flow</i> 0B packages see vincotech.com website.

Vincotech thermistor reference
See Vincotech thermistor reference table at vincotech.com website.

UL recognition and file number
This device is certified according to UL 1557 standard, UL file number E192116. For more information see vincotech.com website. 

Document No.:	Date:	Modification:	Pages
10-0B126PA008SC-M998F09-D3-14	29 Aug. 2021	New Datasheet format, module is unchanged Introduce Rth values with PSX-P7 TIM	

DISCLAIMER

The information, specifications, procedures, methods and recommendations herein (together "information") are presented by Vincotech to reader in good faith, are believed to be accurate and reliable, but may well be incomplete and/or not applicable to all conditions or situations that may exist or occur. Vincotech reserves the right to make any changes without further notice to any products to improve reliability, function or design. No representation, guarantee or warranty is made to reader as to the accuracy, reliability or completeness of said information or that the application or use of any of the same will avoid hazards, accidents, losses, damages or injury of any kind to persons or property or that the same will not infringe third parties rights or give desired results. It is reader's sole responsibility to test and determine the suitability of the information and the product for reader's intended use.

LIFE SUPPORT POLICY

Vincotech products are not authorised for use as critical components in life support devices or systems without the express written approval of Vincotech.

As used herein:

1. Life support devices or systems are devices or systems which, (a) are intended for surgical implant into the body, or (b) support or sustain life, or (c) whose failure to perform when properly used in accordance with instructions for use provided in labelling can be reasonably expected to result in significant injury to the user.
2. A critical component is any component of a life support device or system whose failure to perform can be reasonably expected to cause the failure of the life support device or system, or to affect its safety or effectiveness.