

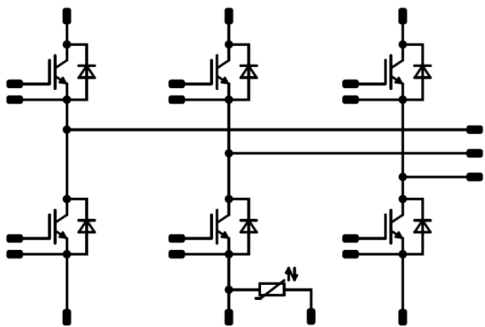

Vincotech

<i>flow</i> PACK 2	1200 V / 50 A
<div style="background-color: #eee; padding: 2px; margin-bottom: 5px;">Features</div> <ul style="list-style-type: none"> IGBT4 (1200 V) technology for low saturation losses and improved EMC behavior Compact and low inductive design Integrated temperature sensor 	<div style="background-color: #eee; padding: 2px; margin-bottom: 5px;"><i>flow</i> 2 17 mm housing</div> 
<div style="background-color: #eee; padding: 2px; margin-bottom: 5px;">Target applications</div> <ul style="list-style-type: none"> Industrial drives 	<div style="background-color: #eee; padding: 2px; margin-bottom: 5px;">Schematic</div> 
<div style="background-color: #eee; padding: 2px; margin-bottom: 5px;">Types</div> <ul style="list-style-type: none"> 30-P2126PA050SC-L287F09Y 	

Maximum Ratings

$T_j = 25\text{ °C}$, unless otherwise specified

Parameter	Symbol	Condition	Value	Unit
Inverter Switch				
Collector-emitter voltage	V_{CES}		1200	V
Collector current	I_C	$T_j = T_{jmax}$ $T_s = 80\text{ °C}$	65	A
Repetitive peak collector current	I_{CRM}	t_p limited by T_{jmax}	150	A
Total power dissipation	P_{tot}	$T_j = T_{jmax}$ $T_s = 80\text{ °C}$	185	W
Gate-emitter voltage	V_{GES}		±20	V
Short circuit ratings	t_{SC}	$T_j \leq 150\text{ °C}$	10	µs
	V_{CC}	$V_{GE} = 15\text{ V}$	800	V
Maximum Junction Temperature	T_{jmax}		175	°C



Vincotech

Maximum Ratings

$T_j = 25\text{ °C}$, unless otherwise specified

Parameter	Symbol	Condition	Value	Unit
Inverter Diode				
Peak Repetitive Reverse Voltage	V_{RRM}		1200	V
Continuous (direct) forward current	I_F	$T_j = T_{jmax}$ $T_s = 80\text{°C}$	65	A
Repetitive peak forward current	I_{FRM}		100	A
Total power dissipation	P_{tot}	$T_j = T_{jmax}$ $T_s = 80\text{°C}$	127	W
Maximum Junction Temperature	T_{jmax}		175	°C

Module Properties

Thermal Properties

Storage temperature	T_{stg}		-40...+125	°C
Operation temperature under switching condition	T_{jop}		-40...(T _{jmax} - 25)	°C

Isolation Properties

Isolation voltage	V_{isol}	DC Test Voltage* $t_p = 2\text{ s}$	4000	V
		AC Voltage $t_p = 1\text{ min}$	2500	V
Creepage distance			min. 12,7	mm
Clearance			min. 12,7	mm
Comparative Tracking Index	CTI		> 200	

*100 % tested in production



Vincotech

Characteristic Values

Parameter	Symbol	Conditions					Value			Unit
		V_{GE} [V] V_{GS} [V]	V_{CE} [V] V_{DS} [V] V_F [V]	I_C [A] I_D [A] I_F [A]	T_j [°C]	Min	Typ	Max		

Inverter Switch

Static

Gate-emitter threshold voltage	$V_{GE(th)}$	$V_{CE} = V_{CE}$			0,0017	25 125	5,3	5,8	6,3	V
Collector-emitter saturation voltage	V_{CEsat}		15		50	25 150	1,58	1,88 2,30	2,07	V
Collector-emitter cut-off current	I_{CES}		0	1200		25			1	μA
Gate-emitter leakage current	I_{GES}		20	0		25			120	nA
Internal gate resistance	r_g							4		Ω
Input capacitance	C_{ies}	$f = 1$ MHz	0	25		25		2800		pF
Reverse transfer capacitance	C_{res}							100		

Thermal

Thermal resistance junction to sink	$R_{th(j-s)}$	phase-change material $\lambda = 3,4$ W/mK						0,51		K/W
-------------------------------------	---------------	---	--	--	--	--	--	------	--	-----

IGBT Switching

Turn-on delay time	$t_{d(on)}$	$R_{gon} = 8$ Ω $R_{goff} = 8$ Ω	±15	600	50	25 150		96 101		ns
Rise time	t_r					25 150		17 24		
Turn-off delay time	$t_{d(off)}$					25 150		214 281		
Fall time	t_f					25 150		87 122		
Turn-on energy (per pulse)	E_{on}					$Q_{iFWD} = 4,8$ μC $Q_{iFWD} = 9,7$ μC				
Turn-off energy (per pulse)	E_{off}					25 150		2,744 4,531		



Vincotech

Characteristic Values

Parameter	Symbol	Conditions					Value			Unit
		V_{GE} [V]	V_{CE} [V]	I_C [A]	T_j [°C]	Min	Typ	Max		

Inverter Diode

Static

Parameter	Symbol	V_{GE} [V]	V_{CE} [V]	I_C [A]	T_j [°C]	Min	Typ	Max	Unit
Forward voltage	V_F			50	25 125 150		1,73 1,70 1,68	2,05	V
Reverse leakage current	I_r		1200		25			10	μ A

Thermal

Parameter	Symbol	Conditions	Value	Unit
Thermal resistance junction to sink	$R_{th(j-s)}$	phase-change material $\lambda = 3,4$ W/mK	0,75	K/W

FWD Switching

Parameter	Symbol	V_{GE} [V]	V_{CE} [V]	I_C [A]	T_j [°C]	Min	Typ	Max	Unit
Peak recovery current	I_{RRM}				25 150		81 85		A
Reverse recovery time	t_{rr}				25 150		139 316		ns
Recovered charge	Q_r	$di/dt = 3866$ A/ μ s $di/dt = 2820$ A/ μ s	± 15	600	50		4,797 9,708		μ C
Reverse recovered energy	E_{rec}				25 150		1,790 3,972		mWs
Peak rate of fall of recovery current	$(di_{rr}/dt)_{max}$				25 150		4803 1209		A/ μ s

Thermistor

Parameter	Symbol	Conditions	Value	Unit
Rated resistance	R		25	k Ω
Deviation of R_{100}	$\Delta_{R/R}$	$R_{100} = 1486$ Ω	100	-12 +14
Power dissipation	P		25	200
Power dissipation constant			25	2
B-value	$B_{(25/50)}$	Tol. $\pm 3\%$	25	3950
B-value	$B_{(25/100)}$	Tol. $\pm 3\%$	25	3998
Vincotech NTC Reference				B



Inverter Switch Characteristics

figure 1. IGBT

Typical output characteristics

$I_C = f(V_{CE})$

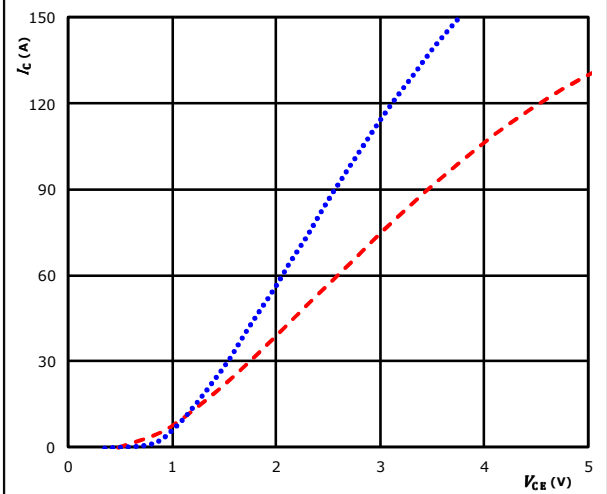

$t_p = 250 \mu s$
 $V_{GE} = 15 V$
 $T_j: 25 \text{ } ^\circ C$ (blue dotted line)
 $150 \text{ } ^\circ C$ (red dashed line)

figure 2. IGBT

Typical output characteristics

$I_C = f(V_{CE})$

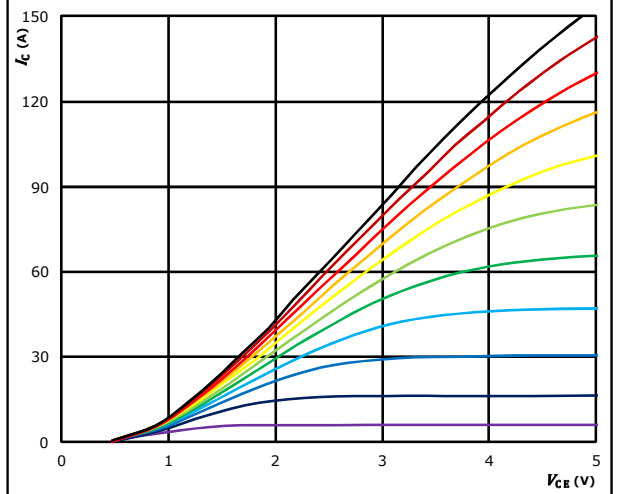

$t_p = 250 \mu s$
 $T_j = 150 \text{ } ^\circ C$
 V_{GE} from 7 V to 17 V in steps of 1 V

figure 3. IGBT

Typical transfer characteristics

$I_C = f(V_{GE})$

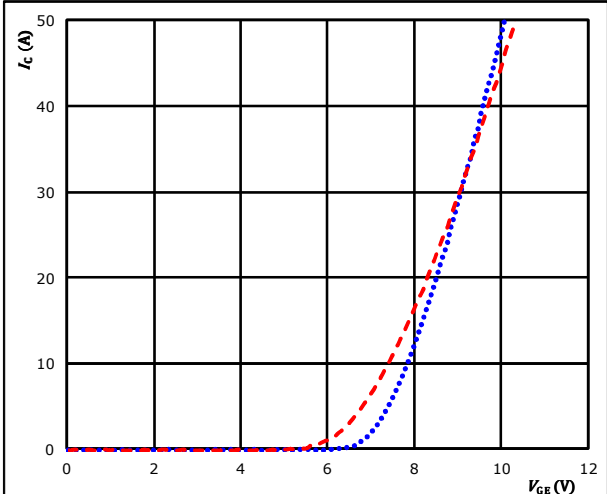

$t_p = 100 \mu s$
 $V_{CE} = 10 V$
 $T_j: 25 \text{ } ^\circ C$ (blue dotted line)
 $150 \text{ } ^\circ C$ (red dashed line)

figure 4. IGBT

Transient Thermal Impedance as function of Pulse duration

$Z_{th(j-s)} = f(t_p)$

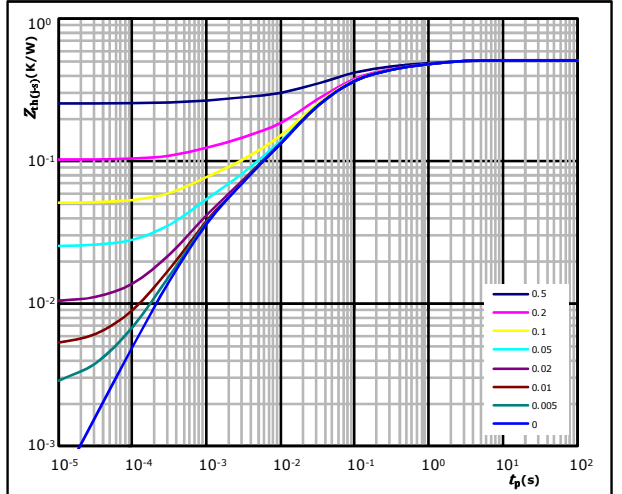

$D = t_p / T$
 $R_{th(j-s)} = 0,51 \text{ K/W}$

IGBT thermal model values

R (K/W)	τ (s)
7,12E-02	1,13E+00
1,15E-01	1,65E-01
2,22E-01	3,78E-02
6,59E-02	1,21E-02
3,86E-02	9,52E-04



Vincotech

Inverter Switch Characteristics

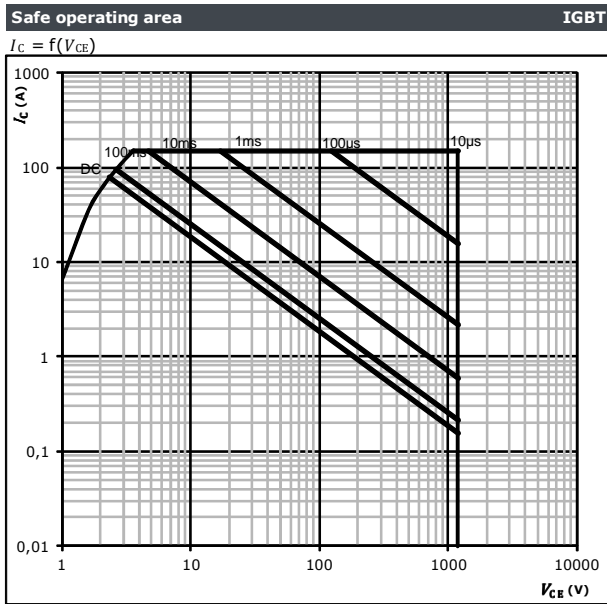

At

- $D =$ single pulse
- $T_s =$ 80 °C
- $V_{GE} =$ ± 15 V
- $T_j = T_{jmax}$



Inverter Diode Characteristics

Typical forward characteristics FWD

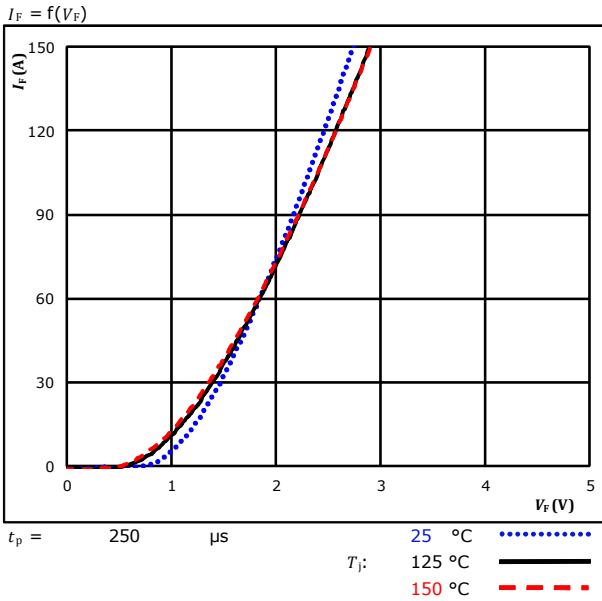

Transient thermal impedance as a function of pulse width FWD

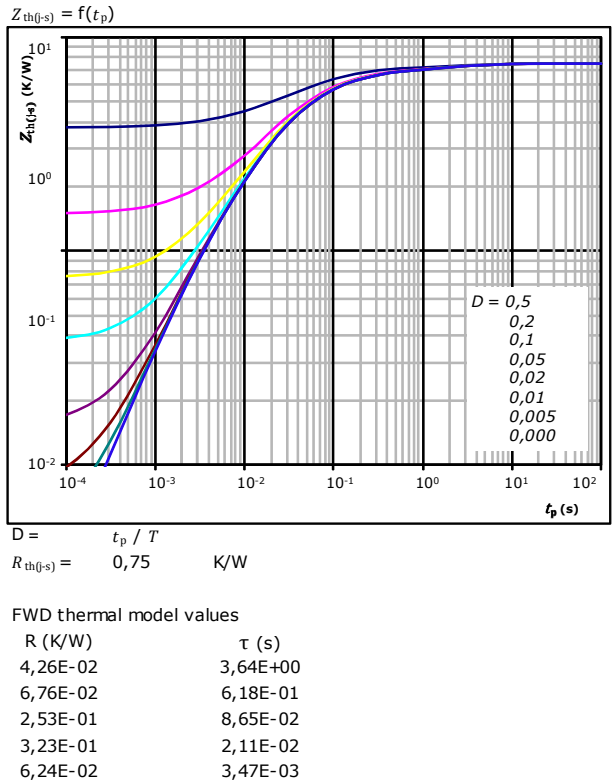

Thermistor Characteristics

figure 1. Thermistor

Typical NTC characteristic as a function of temperature

$R = f(T)$

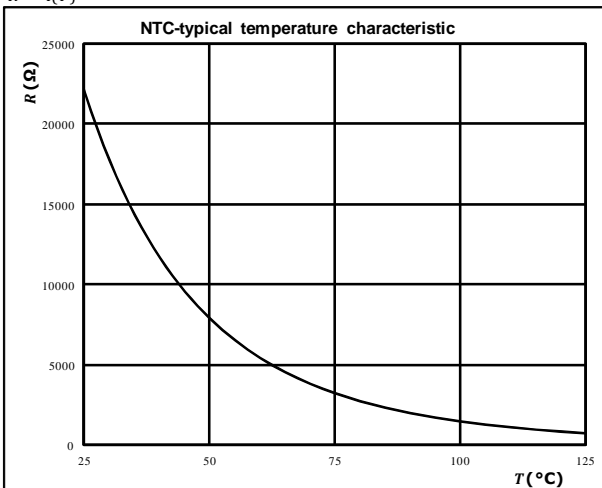



Inverter Switching Definitions

Figure 1. IGBT

Typical switching energy losses as a function of collector current

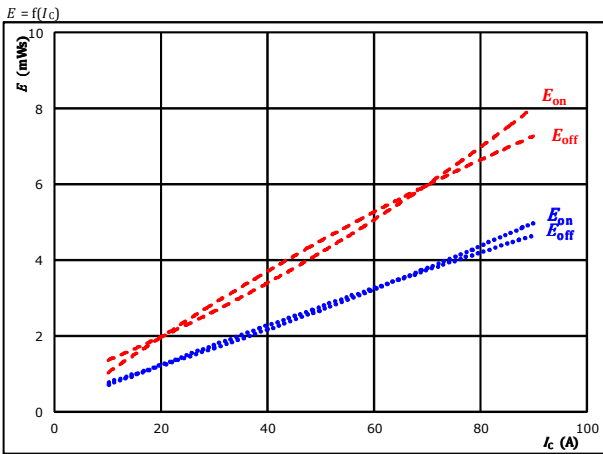

With an inductive load at
 $V_{CE} = 600$ V
 $V_{GE} = \pm 15$ V
 $R_{gon} = 8$ Ω
 $R_{goff} = 8$ Ω
 $T_j: 25$ °C (blue dotted line)
 150 °C (red dashed line)

Figure 2. IGBT

Typical switching energy losses as a function of gate resistor

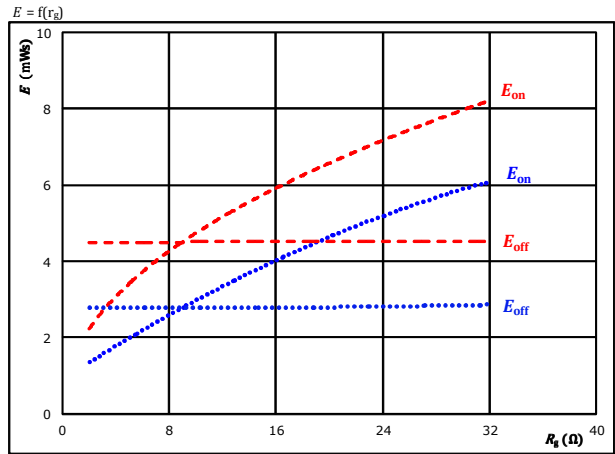

With an inductive load at
 $V_{CE} = 600$ V
 $V_{GE} = \pm 15$ V
 $I_C = 50$ A
 $T_j: 25$ °C (blue dotted line)
 150 °C (red dashed line)

Figure 3. FWD

Typical reverse recovered energy loss as a function of collector current

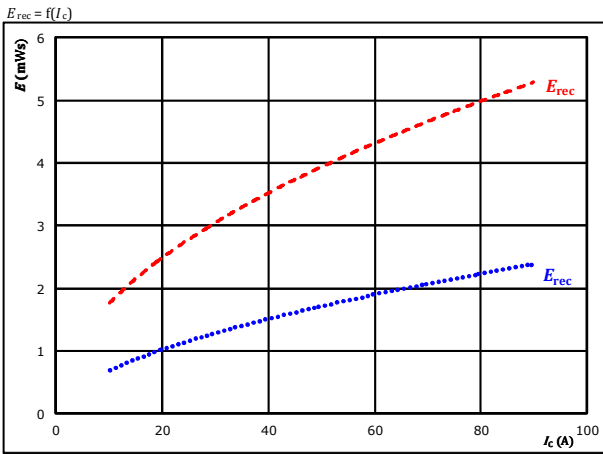

With an inductive load at
 $V_{CE} = 600$ V
 $V_{GE} = \pm 15$ V
 $R_{gon} = 8$ Ω
 $T_j: 25$ °C (blue dotted line)
 150 °C (red dashed line)

Figure 4. FWD

Typical reverse recovered energy loss as a function of gate resistor

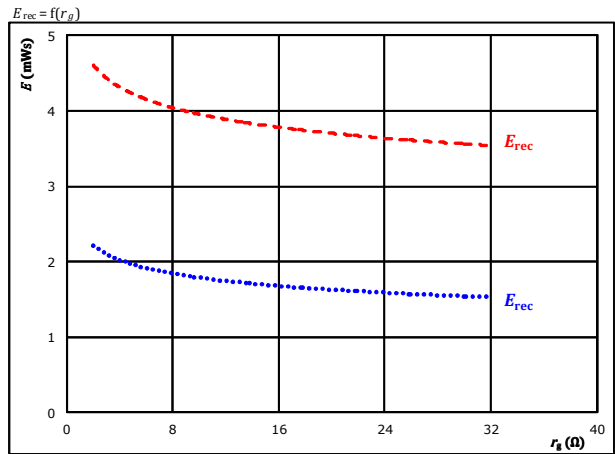

With an inductive load at
 $V_{CE} = 600$ V
 $V_{GE} = \pm 15$ V
 $I_C = 50$ A
 $T_j: 25$ °C (blue dotted line)
 150 °C (red dashed line)



Inverter Switching Definitions

Figure 5. IGBT

Typical switching times as a function of collector current

$$t = f(I_c)$$

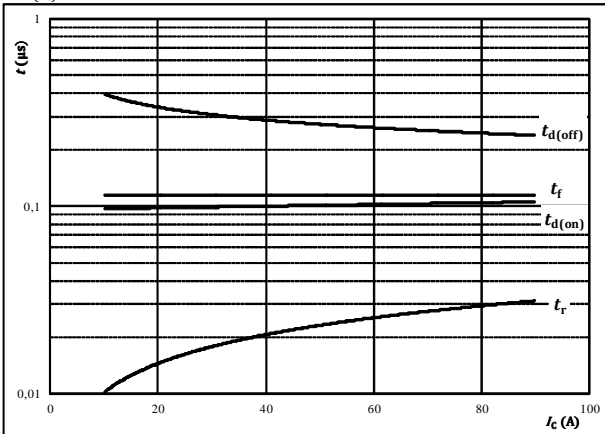

With an inductive load at

$T_j =$	150	°C
$V_{CE} =$	600	V
$V_{GE} =$	±15	V
$R_{gon} =$	8	Ω
$R_{goff} =$	8	Ω

Figure 6. IGBT

Typical switching times as a function of gate resistor

$$t = f(r_g)$$

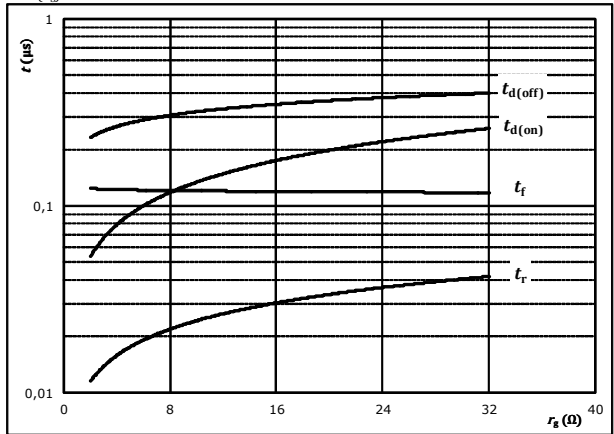

With an inductive load at

$T_j =$	150	°C
$V_{CE} =$	600	V
$V_{GE} =$	±15	V
$I_c =$	50	A

Figure 7. FWD

Typical reverse recovery time as a function of collector current

$$t_{rr} = f(I_c)$$

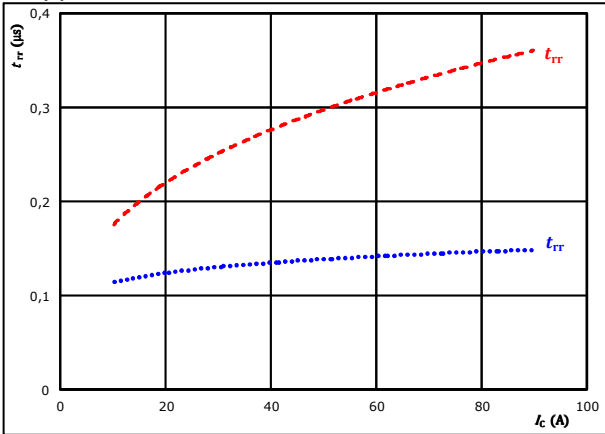

At

$V_{CE} =$	600	V
$V_{GE} =$	±15	V
$R_{gon} =$	8	Ω

$T_j:$	25 °C
	150 °C	-----

Figure 8. FWD

Typical reverse recovery time as a function of IGBT turn on gate resistor

$$t_{rr} = f(R_{gon})$$

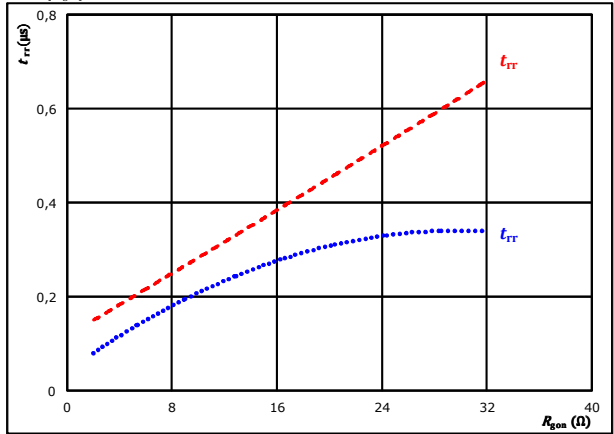

At

$V_{CE} =$	600	V
$V_{GE} =$	±15	V
$I_c =$	50	A

$T_j:$	25 °C
	150 °C	-----



Inverter Switching Definitions

Figure 9. FWD

Typical recovered charge as a function of collector current

$$Q_r = f(I_c)$$

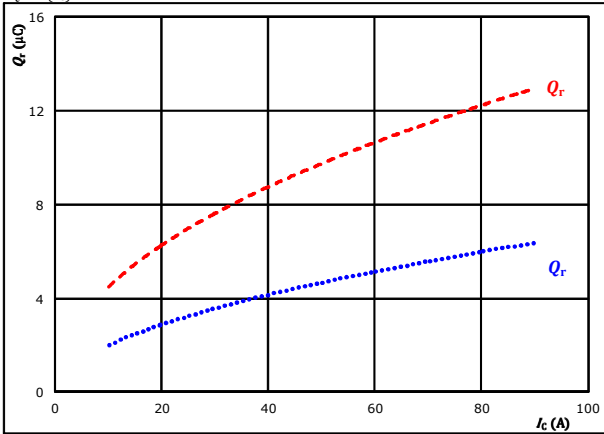

At $V_{CE} = 600$ V
 $V_{GE} = \pm 15$ V
 $R_{gpn} = 8$ Ω
 $T_j: 25$ °C (blue dotted line)
 150 °C (red dashed line)

Figure 10. FWD

Typical recovered charge as a function of IGBT turn on gate resistor

$$Q_r = f(R_{gpn})$$

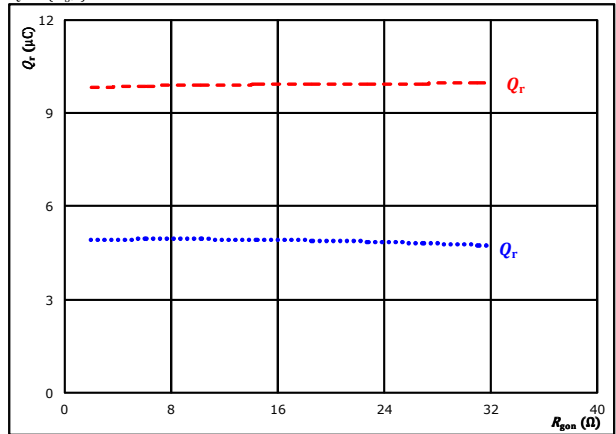

At $V_{CE} = 600$ V
 $V_{GE} = \pm 15$ V
 $I_c = 50$ A
 $T_j: 25$ °C (blue dotted line)
 150 °C (red dashed line)

Figure 11. FWD

Typical peak reverse recovery current current as a function of collector current

$$I_{RM} = f(I_c)$$

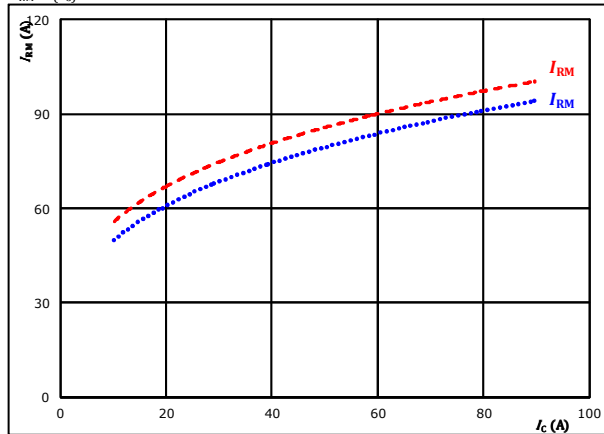

At $V_{CE} = 600$ V
 $V_{GE} = \pm 15$ V
 $R_{gpn} = 8$ Ω
 $T_j: 25$ °C (blue dotted line)
 150 °C (red dashed line)

Figure 12. FWD

Typical peak reverse recovery current current as a function of IGBT turn on gate resistor

$$I_{RM} = f(R_{gpn})$$

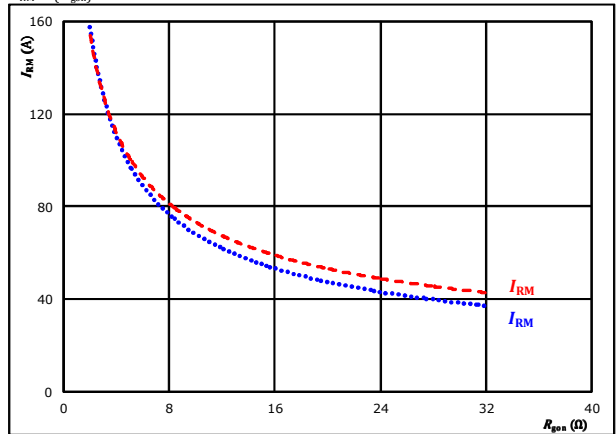

At $V_{CE} = 600$ V
 $V_{GE} = \pm 15$ V
 $I_c = 50$ A
 $T_j: 25$ °C (blue dotted line)
 150 °C (red dashed line)



Inverter Switching Definitions

Figure 13. FWD

Typical rate of fall of forward and reverse recovery current as a function of collector current
 $di_f/dt, di_{rr}/dt = f(I_c)$

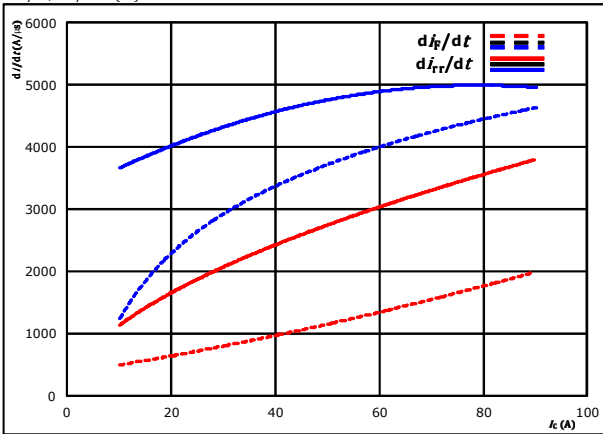

At $V_{CE} = 600$ V $T_j = 25$ °C (dotted blue)
 $V_{GE} = \pm 15$ V $T_j = 150$ °C (dashed red)
 $R_{gon} = 8$ Ω

Figure 14. FWD

Typical rate of fall of forward and reverse recovery current as a function of IGBT turn on gate resistor
 $di_f/dt, di_{rr}/dt = f(R_g)$

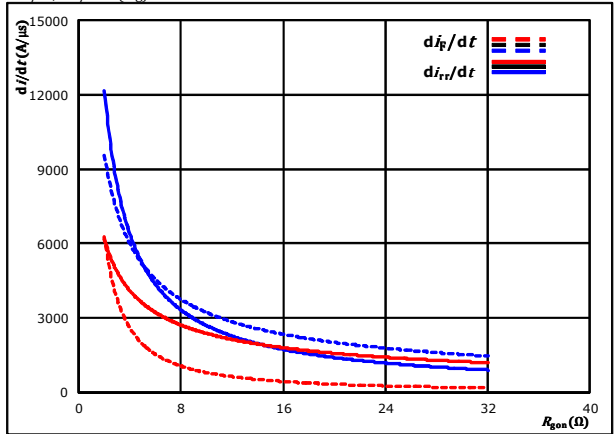

At $V_{CE} = 600$ V $T_j = 25$ °C (dotted blue)
 $V_{GE} = \pm 15$ V $T_j = 150$ °C (dashed red)
 $I_c = 50$ A

Figure 15. IGBT

Reverse bias safe operating area

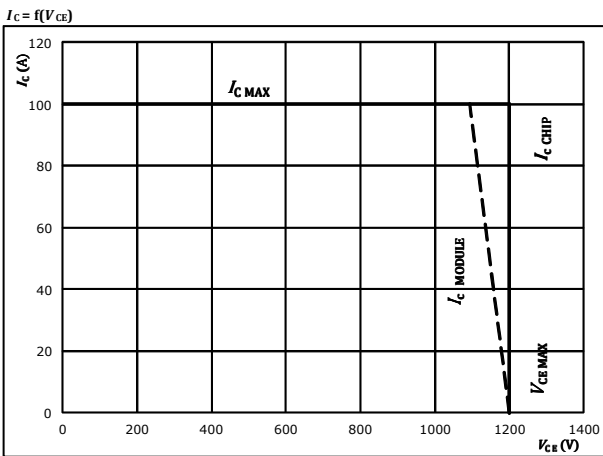

At $T_j = 175$ °C
 $R_{gon} = 8$ Ω
 $R_{goff} = 8$ Ω



Inverter Switching Characteristics

General conditions

T_j	=	150 °C
R_{gon}	=	8 Ω
R_{goff}	=	8 Ω

Figure 1. IGBT

Turn-off Switching Waveforms & definition of t_{doff} , t_{Eoff} (t_{Eoff} = integrating time for E_{off})

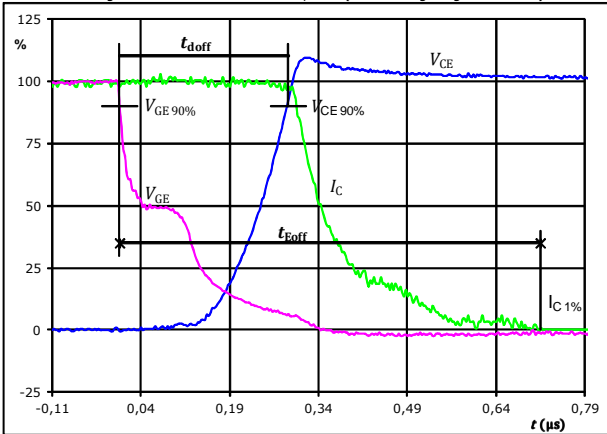

$V_{GE}(0\%)$ =	-15	V
$V_{GE}(100\%)$ =	15	V
$V_C(100\%)$ =	600	V
$I_C(100\%)$ =	50	A
t_{doff} =	0,281	μ s
t_{Eoff} =	0,710	μ s

Figure 2. IGBT

Turn-on Switching Waveforms & definition of t_{don} , t_{Eon} (t_{Eon} = integrating time for E_{on})

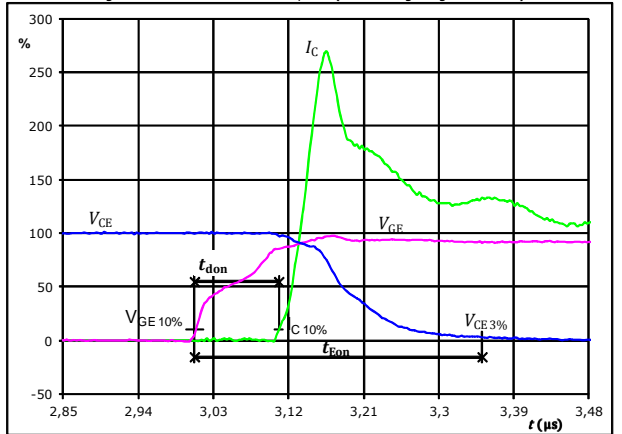

$V_{GE}(0\%)$ =	-15	V
$V_{GE}(100\%)$ =	15	V
$V_C(100\%)$ =	600	V
$I_C(100\%)$ =	50	A
t_{don} =	0,101	μ s
t_{Eon} =	0,345	μ s

Figure 3. IGBT

Turn-off Switching Waveforms & definition of t_f

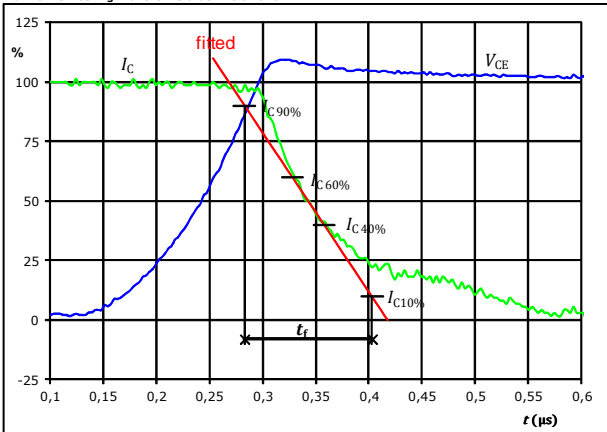

$V_C(100\%)$ =	600	V
$I_C(100\%)$ =	50	A
t_f =	0,122	μ s

Figure 4. IGBT

Turn-on Switching Waveforms & definition of t_r

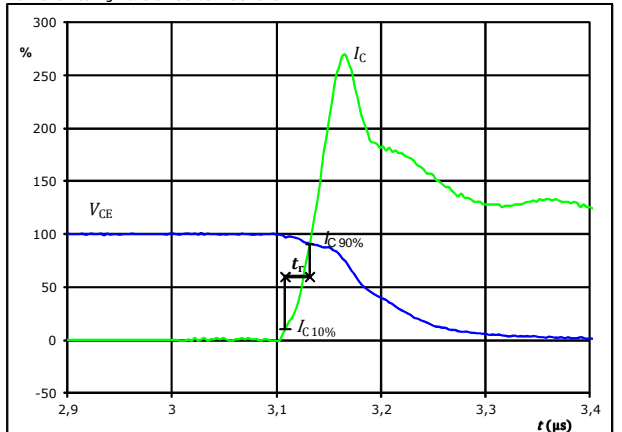

$V_C(100\%)$ =	600	V
$I_C(100\%)$ =	50	A
t_r =	0,024	μ s



Vincotech

Inverter Switching Characteristics

Figure 5. IGBT

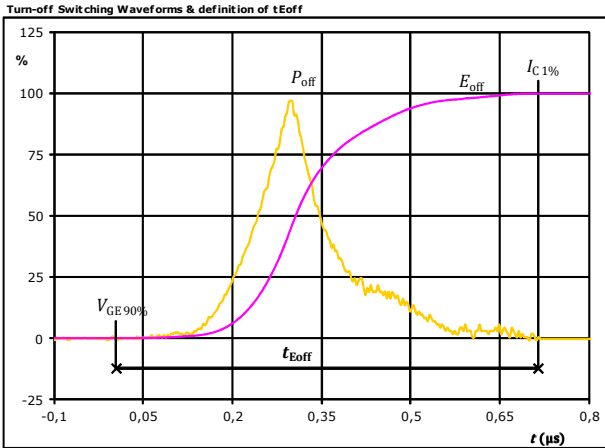

$P_{off}(100\%) = 30,10$ kW
 $E_{off}(100\%) = 4,53$ mJ
 $t_{Eoff} = 0,71$ μ s

Figure 6. IGBT

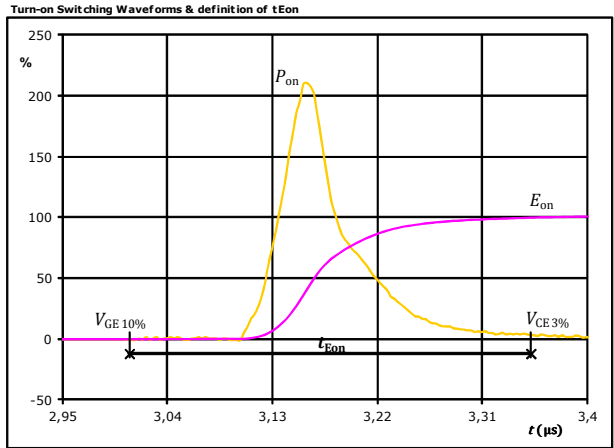

$P_{on}(100\%) = 30,10$ kW
 $E_{on}(100\%) = 4,21$ mJ
 $t_{Eon} = 0,345$ μ s

Figure 7. FWD

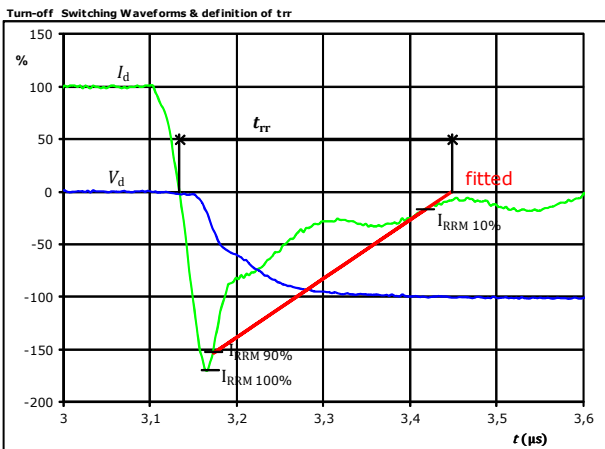

$V_d(100\%) = 600$ V
 $I_d(100\%) = 50$ A
 $I_{RRM}(100\%) = -85$ A
 $t_{tr} = 0,316$ μ s



Vincotech

Inverter Switching Characteristics

Figure 8. FWD

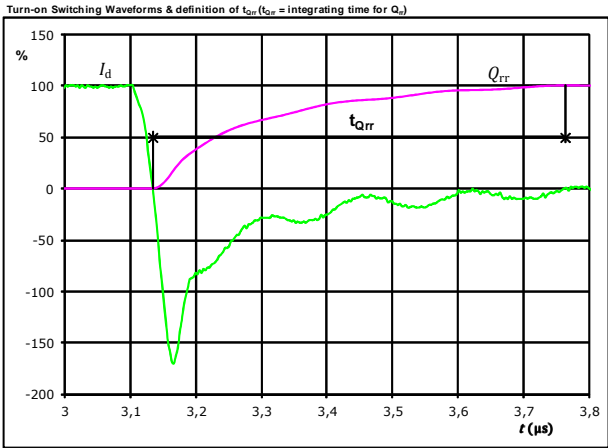

I_d (100%) =	50	A
Q_{rr} (100%) =	9,71	μC
t_{Qrr} =	0,63	μs

Figure 9. FWD

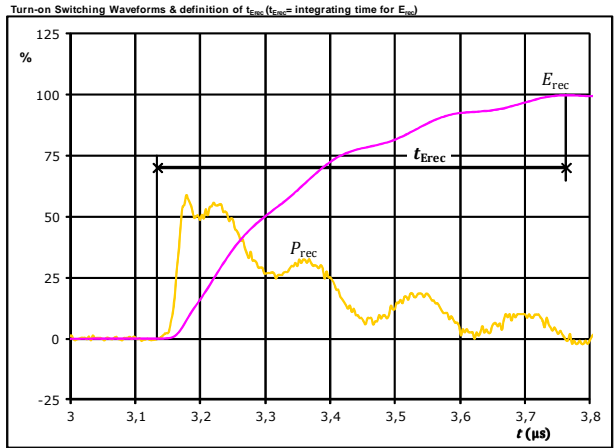

P_{rec} (100%) =	30,10	kW
E_{rec} (100%) =	3,97	mJ
t_{Erec} =	0,63	μs



Vincotech

Ordering Code & Marking																																
Version			Ordering Code																													
without thermal paste 17 mm housing			30-P2126PA050SC-L287F09Y																													
<table border="1"> <thead> <tr> <th rowspan="2">Text</th> <th colspan="2">Name</th> <th>Date code</th> <th>UL & VIN</th> <th>Lot</th> <th>Serial</th> </tr> <tr> <th>Type&Ver</th> <th>Lot number</th> <th>Serial</th> <th>Date code</th> <td></td> <td></td> </tr> </thead> <tbody> <tr> <td rowspan="2"> NN-NNNNNNNNNNNN TTTTIVVWWYY UL VIN LLLLL SSSS </td> <td colspan="2">N-NNNNNNNNNNNNNN-TTTTTV</td> <td>WWYY</td> <td>UL VIN</td> <td>LLLLL</td> <td>SSSS</td> </tr> <tr> <td>TTTTTIVV</td> <td>LLLLL</td> <td>SSSS</td> <td>WWYY</td> <td></td> <td></td> </tr> </tbody> </table>							Text	Name		Date code	UL & VIN	Lot	Serial	Type&Ver	Lot number	Serial	Date code			NN-NNNNNNNNNNNN TTTTIVVWWYY UL VIN LLLLL SSSS	N-NNNNNNNNNNNNNN-TTTTTV		WWYY	UL VIN	LLLLL	SSSS	TTTTTIVV	LLLLL	SSSS	WWYY		
Text	Name		Date code	UL & VIN	Lot	Serial																										
	Type&Ver	Lot number	Serial	Date code																												
NN-NNNNNNNNNNNN TTTTIVVWWYY UL VIN LLLLL SSSS	N-NNNNNNNNNNNNNN-TTTTTV		WWYY	UL VIN	LLLLL	SSSS																										
	TTTTTIVV	LLLLL	SSSS	WWYY																												

Outline

Pin table [mm]			
Pin	X	Y	Function
1	0,9	0	S11
2	0,9	3	G11
3	3,9	0	DC-1
4	3,9	2,7	DC-1
5	3,9	5,4	DC-1
6	6,6	0	DC-1
7	15,2	0	DC+1
8	15,2	2,7	DC+1
9	17,9	0	DC+1
10	17,9	2,7	DC+1
11	26,2	0	S13
12	26,2	3	G13
13	29,2	0	DC-2
14	29,2	2,7	DC-2
15	29,2	5,4	DC-2
16	31,9	0	DC-2
17	32,2	4,05	NTC
18	40,5	0	DC+2
19	40,5	2,7	DC+2
20	43,2	0	DC+2
21	43,2	2,7	DC+2
22	51,5	0	S15
23	51,5	3	G15
24	54,5	0	DC-3
25	54,5	2,7	DC-3
26	54,5	5,4	DC-3
27	57,2	0	DC-3
28	65,8	0	DC+3
29	65,8	2,7	DC+3
30	68,5	0	DC+3
31	68,5	2,7	DC+3
32	64,7	36	G16
33	61,7	36	S16
34	58,7	36	PH3
35	56	36	PH3
36	53,3	36	PH3
37	50,6	36	PH3
38	39,4	36	G14
39	36,4	36	S14
40	33,4	36	PH2
41	30,7	36	PH2
42	28	36	PH2
43	25,3	36	PH2
44	14,1	36	G12
45	11,1	36	S12
46	8,1	36	PH1
47	5,4	36	PH1
48	2,7	36	PH1
49	0	36	PH1

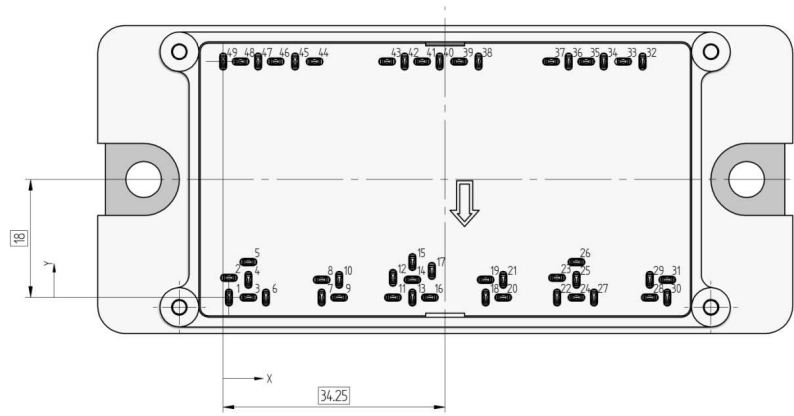
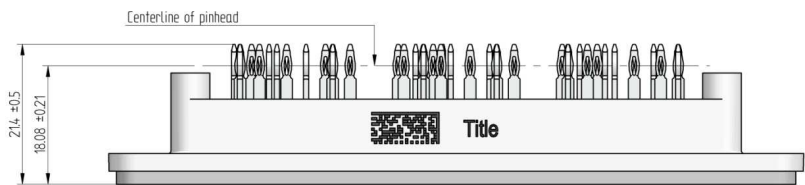

Tolerance of pinpositions: ±0.5 mm at the end of pins
Dimension of coordinate axis is only offset without tolerance



Vincotech

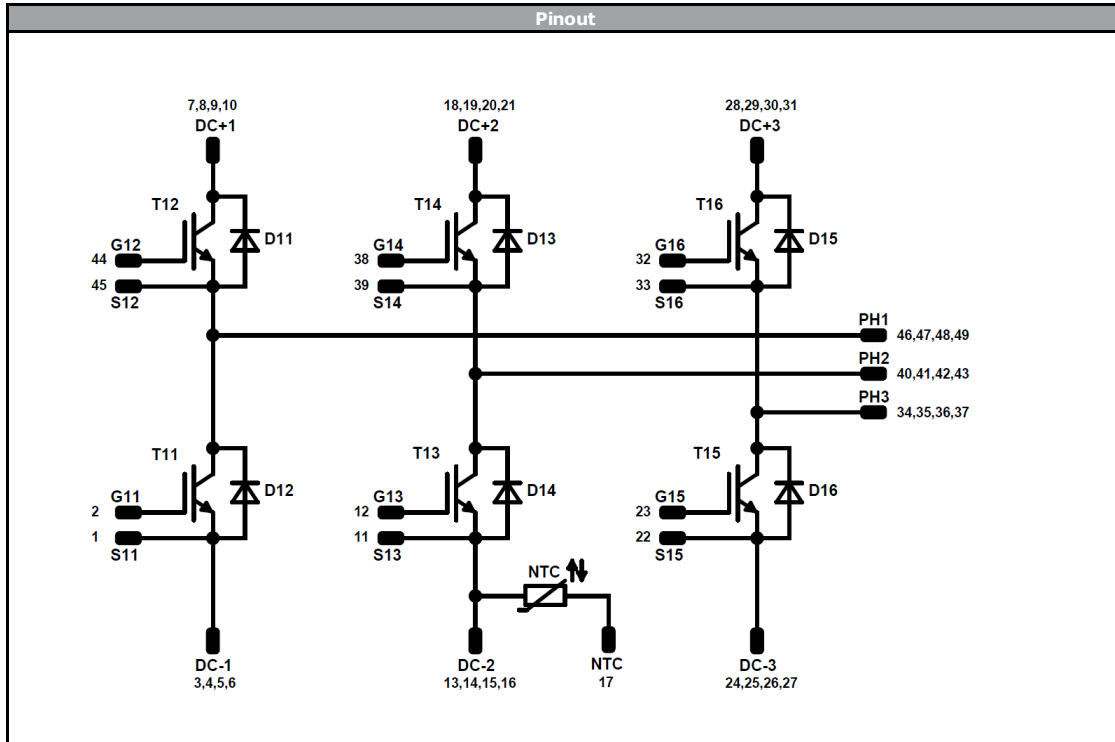

Identification					
ID	Component	Voltage	Current	Function	Comment
T11 , T12 , T13 , T14 , T15 , T16	IGBT	1200 V	50 A	Inverter Switch	
D11 , D12 , D13 , D14 , D15 , D16	FWD	1200 V	50 A	Inverter Diode	
NTC	Thermistor			Thermistor	



Vincotech

Packaging instruction			
Standard packaging quantity (SPQ)	36	>SPQ	Standard
		<SPQ	Sample

Handling instruction
Handling instructions for <i>flow 2</i> packages see vincotech.com website.

Package data
Package data for <i>flow 2</i> packages see vincotech.com website.

UL recognition and file number
This device is certified according to UL 1557 standard, UL file number E192116. For more information see vincotech.com website. 

Document No.:	Date:	Modification:	Pages
30-x2126PA050SC-L287F09x-D3-14	31 May. 2017	New package quantity	All

DISCLAIMER

The information, specifications, procedures, methods and recommendations herein (together "information") are presented by Vincotech to reader in good faith, are believed to be accurate and reliable, but may well be incomplete and/or not applicable to all conditions or situations that may exist or occur. Vincotech reserves the right to make any changes without further notice to any products to improve reliability, function or design. No representation, guarantee or warranty is made to reader as to the accuracy, reliability or completeness of said information or that the application or use of any of the same will avoid hazards, accidents, losses, damages or injury of any kind to persons or property or that the same will not infringe third parties rights or give desired results. It is reader's sole responsibility to test and determine the suitability of the information and the product for reader's intended use.

LIFE SUPPORT POLICY

Vincotech products are not authorised for use as critical components in life support devices or systems without the express written approval of Vincotech.

As used herein:

1. Life support devices or systems are devices or systems which, (a) are intended for surgical implant into the body, or (b) support or sustain life, or (c) whose failure to perform when properly used in accordance with instructions for use provided in labelling can be reasonably expected to result in significant injury to the user.
2. A critical component is any component of a life support device or system whose failure to perform can be reasonably expected to cause the failure of the life support device or system, or to affect its safety or effectiveness.