

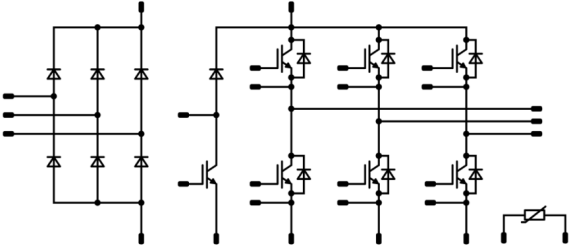

Vincotech

10-FY12PMA015M7-P587A78
10-PY12PMA015M7-P587A78Y
10-F112PMA015M7-P587A79
 datasheet

<i>flow PIM 1</i>	1200 V / 15 A
<div style="background-color: #eee; padding: 5px; margin-bottom: 10px;">Features</div> <ul style="list-style-type: none"> IGBT M7 with low V_{CEsat} and improved EMC behavior Open emitter configuration Compact and low inductive design Built-in NTC <div style="background-color: #eee; padding: 5px; margin-bottom: 10px;">Target applications</div> <ul style="list-style-type: none"> Industrial Drives <div style="background-color: #eee; padding: 5px;">Types</div> <ul style="list-style-type: none"> 10-FY12PMA015M7-P587A78 10-PY12PMA015M7-P587A78Y 10-F112PMA015M7-P587A79 	<div style="background-color: #eee; padding: 5px; margin-bottom: 10px;">flow 1 housing</div> <div style="text-align: center;">  </div> <div style="display: flex; justify-content: space-around; font-size: small;"> <div style="text-align: center;">12 mm housing solder pins</div> <div style="text-align: center;">12 mm housing press-fit pins</div> <div style="text-align: center;">17 mm housing solder pins</div> </div> <div style="background-color: #eee; padding: 5px; margin-top: 10px;">Schematic</div> <div style="text-align: center;">  </div>

Maximum Ratings

$T_j = 25\text{ °C}$, unless otherwise specified

Parameter	Symbol	Condition	Value	Unit
Rectifier Diode				
Peak Repetitive Reverse Voltage	V_{RRM}		1600	V
Continuous (direct) forward current	I_F		35	A
Surge (non-repetitive) forward current	I_{FSM}	50 Hz Single Half Sine Wave $t_p = 10\text{ ms}$ $T_j = 150\text{ °C}$	270	A
Surge current capability	I_{Pt}		370	A^2s
Total power dissipation	P_{tot}	$T_j = T_{jmax}$ $T_s = 80\text{ °C}$	56	W
Maximum Junction Temperature	T_{jmax}		150	°C



Maximum Ratings

$T_j = 25\text{ °C}$, unless otherwise specified

Parameter	Symbol	Condition	Value	Unit
Inverter Switch				
Collector-emitter voltage	V_{CES}		1200	V
Collector current	I_C		15	A
Repetitive peak collector current	I_{CRM}	t_p limited by T_{jmax}	30	A
Total power dissipation	P_{tot}	$T_j = T_{jmax}$ $T_s = 80\text{ °C}$	60	W
Gate-emitter voltage	V_{GES}		± 20	V
Maximum junction temperature	T_{jmax}		175	°C
Inverter Diode				
Peak repetitive reverse voltage	V_{RRM}		1200	V
Continuous (direct) forward current	I_F		15	A
Repetitive peak forward current	I_{FRM}	T_j limited by T_{jmax}	30	A
Total power dissipation	P_{tot}	$T_j = T_{jmax}$ $T_s = 80\text{ °C}$	45	W
Maximum junction temperature	T_{jmax}		175	°C
Brake Switch				
Collector-emitter voltage	V_{CES}		1200	V
Collector current	I_C		10	A
Repetitive peak collector current	I_{CRM}	t_p limited by T_{jmax}	20	A
Total power dissipation	P_{tot}	$T_j = T_{jmax}$ $T_s = 80\text{ °C}$	61	W
Gate-emitter voltage	V_{GES}		± 20	V
Maximum junction temperature	T_{jmax}		175	°C
Brake Diode				
Peak repetitive reverse voltage	V_{RRM}		1200	V
Continuous (direct) forward current	I_F		10	A
Repetitive peak forward current	I_{FRM}	T_j limited by T_{jmax}	20	A
Total power dissipation	P_{tot}	$T_j = T_{jmax}$ $T_s = 80\text{ °C}$	50	W
Maximum junction temperature	T_{jmax}		175	°C



Maximum Ratings

$T_j = 25\text{ °C}$, unless otherwise specified

Parameter	Symbol	Condition	Value	Unit
-----------	--------	-----------	-------	------

Module Properties

Thermal Properties

Storage temperature	T_{stg}		-40...+125	°C
Operation temperature under switching condition	T_{top}		-40...(T _{max} - 25)	°C

Isolation Properties

Isolation voltage	V_{isol}	DC Test Voltage* $t_p = 2\text{ s}$	6000	V
		AC Voltage $t_p = 1\text{ min}$	2500	V
Creepage distance			min. 12,7	mm
Clearance		12 mm housing with solder pins / press-fit pins	7,91 / 7,96	mm
		17 mm housing with solder pins	min. 12,7	
Comparative Tracking Index	CTI		> 200	

*100 % tested in production



Characteristic Values

Parameter	Symbol	Conditions					Value			Unit
		V_{GE} [V] V_{GS} [V]	V_{CE} [V] V_{DS} [V] V_F [V]	I_C [A] I_D [A] I_F [A]	T_j [°C]	Min	Typ	Max		

Rectifier Diode

Static

Forward voltage	V_F				35	25 125	0,8	1,17 1,13	1,6	V
Reverse leakage current	I_r			1600		25 145			50 1100	μ A

Thermal

Thermal resistance junction to sink	$R_{th(j-s)}$	$\lambda_{paste} = 3,4$ W/mK (PSX)						1,25		K/W
-------------------------------------	---------------	------------------------------------	--	--	--	--	--	------	--	-----

Inverter Switch

Static

Gate-emitter threshold voltage	$V_{GE(th)}$	$V_{GE} = V_{CE}$				0,0015	25	5,4	6	6,6	V
Collector-emitter saturation voltage	V_{CEsat}		15		15	25 125 150			1,70 1,95 2,01	1,95	V
Collector-emitter cut-off current	I_{CES}		0	1200		25				60	μ A
Gate-emitter leakage current	I_{GES}		20	0		25				500	nA
Internal gate resistance	r_g								none		Ω
Input capacitance	C_{ies}								2900		pF
Output capacitance	C_{oes}		0	10		25			120		
Reverse transfer capacitance	C_{res}								34		
Gate charge	Q_g		15	600	15	25			110		nC

Thermal

Thermal resistance junction to sink	$R_{th(j-s)}$	$\lambda_{paste} = 3,4$ W/mK (PSX)							1,60		K/W
-------------------------------------	---------------	------------------------------------	--	--	--	--	--	--	------	--	-----

Dynamic

Turn-on delay time	$t_{d(on)}$					25 150			176 174		ns
Rise time	t_r	$R_{goff} = 32 \Omega$ $R_{gon} = 32 \Omega$				25 150			43 48		
Turn-off delay time	$t_{d(off)}$		± 15	600	15	25 150			191 218		
Fall time	t_f					25 150			119 127		
Turn-on energy (per pulse)	E_{on}	$Q_{iFWD} = 1,5 \mu$ C $Q_{rFWD} = 2,6 \mu$ C				25 150			1,548 2,008		mWs
Turn-off energy (per pulse)	E_{off}					25 150			0,925 1,322		



Vincotech

10-FY12PMA015M7-P587A78
10-PY12PMA015M7-P587A78Y
10-F112PMA015M7-P587A79
 datasheet

Characteristic Values

Parameter	Symbol	Conditions					Value			Unit
		V_{GE} [V] V_{GS} [V]	V_{CE} [V] V_{DS} [V]	I_C [A] I_D [A]	I_D [A] I_F [A]	T_j [°C]	Min	Typ	Max	

Inverter Diode

Static

Forward voltage	V_F				15	25 125 150		1,63 1,74 1,73	2,1	V
Reverse leakage current	I_R			1200		25			30	μ A

Thermal

Thermal resistance junction to sink	$R_{th(j-s)}$	$\lambda_{paste} = 3,4$ W/mK (PSX)						2,11		K/W
-------------------------------------	---------------	---------------------------------------	--	--	--	--	--	------	--	-----

Dynamic

Peak recovery current	I_{RRM}					25 150		11 12		A
Reverse recovery time	t_{rr}					25 150		265 423		ns
Recovered charge	Q_r	$di/dt = 293$ A/ μ s $di/dt = 244$ A/ μ s	± 15	600	15	25 150		1,549 2,592		μ C
Reverse recovered energy	E_{rec}					25 150		0,488 0,938		mWs
Peak rate of fall of recovery current	$(di_{rf}/dt)_{max}$					25 150		92 52		A/ μ s



Characteristic Values

Parameter	Symbol	Conditions					Value			Unit
		V_{GS} [V]	V_{GE} [V]	V_{DS} [V]	I_D [A]	T_j [°C]	Min	Typ	Max	

Brake Switch

Static

Parameter	Symbol	Conditions	V_{GS} [V]	V_{GE} [V]	V_{DS} [V]	I_D [A]	T_j [°C]	Min	Typ	Max	Unit
Gate-emitter threshold voltage	$V_{GE(th)}$	$V_{GE} = V_{CE}$				0,001	25	5,4	6	6,6	V
Collector-emitter saturation voltage	V_{CEsat}		15			10	25 125 150		1,66 1,90 1,96	1,95	V
Collector-emitter cut-off current	I_{CES}		0	1200			25			55	μA
Gate-emitter leakage current	I_{GES}		20	0			25			500	nA
Internal gate resistance	r_g								none		Ω
Input capacitance	C_{ies}								2000		pF
Output capacitance	C_{oes}		0	10		25			86		
Reverse transfer capacitance	C_{res}								23		
Gate charge	Q_g		15	600	10	25			80		nC

Thermal

Parameter	Symbol	Conditions	V_{GS} [V]	V_{GE} [V]	V_{DS} [V]	I_D [A]	T_j [°C]	Min	Typ	Max	Unit
Thermal resistance junction to sink	$R_{th(j-s)}$	$\lambda_{paste} = 3,4$ W/mK (PSX)							1,57		K/W

Dynamic

Parameter	Symbol	Conditions	V_{GS} [V]	V_{GE} [V]	V_{DS} [V]	I_D [A]	T_j [°C]	Min	Typ	Max	Unit
Turn-on delay time	$t_{d(on)}$	$R_{goff} = 32$ Ω $R_{gon} = 32$ Ω	15/0	600	10		25 125 150		72		ns
Rise time	t_r								68		
Turn-off delay time	$t_{d(off)}$								68		
Fall time	t_f								46		
Turn-on energy (per pulse)	E_{on}	$Q_{tFWD} = 1$ μC $Q_{tFWD} = 1,6$ μC $Q_{tFWD} = 1,8$ μC	15/0	600	10		25 125 150		0,973		mWs
Turn-off energy (per pulse)	E_{off}								1,253		
									1,332		
									0,647		
							25 125 150		0,863		
									0,916		



Characteristic Values

Parameter	Symbol	Conditions					Value			Unit
		V_{GE} [V]	V_{CE} [V]	I_C [A]	T_j [°C]	Min	Typ	Max		

Brake Diode

Static

Parameter	Symbol	V_{GS} [V]	V_{DS} [V]	I_D [A]	I_F [A]	T_j [°C]	Min	Typ	Max	Unit
Forward voltage	V_F			10		25 125 150		1,61 1,69 1,69	2,1	V
Reverse leakage current	I_R		1200			25			25	μA

Thermal

Parameter	Symbol	Conditions	Value	Unit
Thermal resistance junction to sink	$R_{th(j-s)}$	$\lambda_{paste} = 3,4$ W/mK (PSX)	1,91	K/W

Dynamic

Parameter	Symbol	di/dt	V_{GS} [V]	V_{DS} [V]	I_D [A]	T_j [°C]	Min	Typ	Max	Unit
Peak recovery current	I_{RRM}					25 125 150		7 8 8		A
Reverse recovery time	t_{rr}					25 125 150		265 396 448		ns
Recovered charge	Q_r	$di/dt = 165$ A/μs $di/dt = 148$ A/μs $di/dt = 153$ A/μs	15/0	600	10	25 125 150		0,989 1,568 1,773		μC
Reverse recovered energy	E_{rec}					25 125 150		0,337 0,577 0,666		mWs
Peak rate of fall of recovery current	$(di_{rr}/dt)_{max}$					25 125 150		59 41 35		A/μs

Thermistor

Parameter	Symbol	Conditions	Value	Unit
Rated resistance	R		25	kΩ
Deviation of R_{100}	$\Delta_{R/R}$	$R_{100} = 1484$ Ω	100	%
Power dissipation	P		25	mW
Power dissipation constant			25	mW/K
B-value	$B_{(25/50)}$	Tol. ±1 %	25	K
B-value	$B_{(25/100)}$	Tol. ±1 %	25	K
Vincotech NTC Reference				I



Rectifier Diode Characteristics

figure 1. Rectifier Diode
Typical forward characteristics

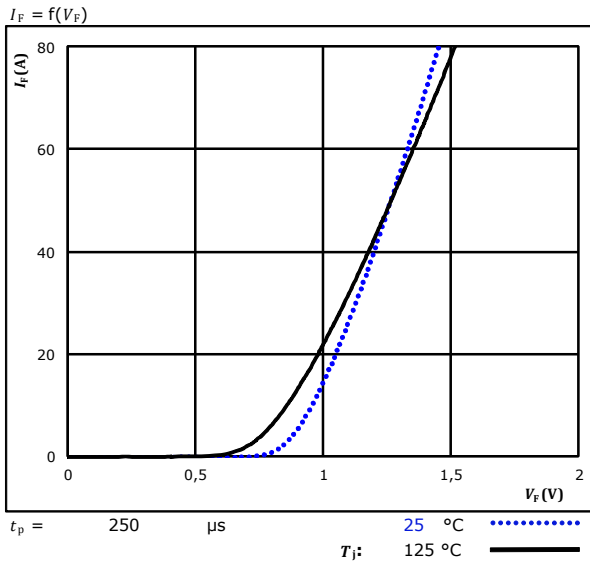
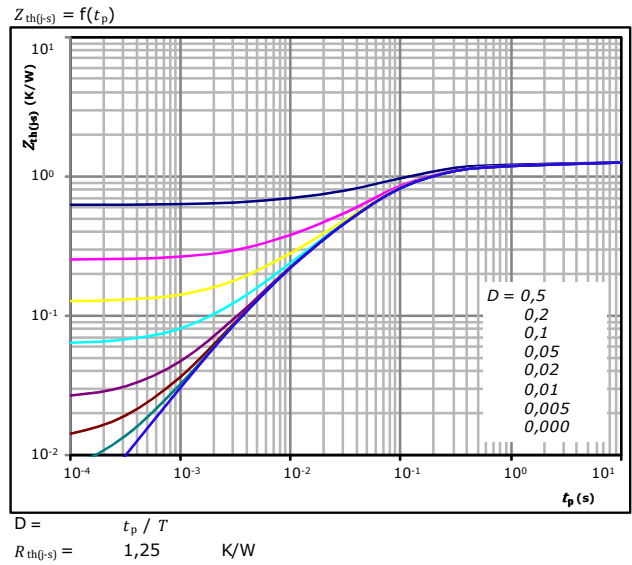

figure 2. Rectifier Diode
Transient thermal impedance as a function of pulse width



Diode thermal model values

R (K/W)	τ (s)
8,00E-02	5,22E+00
1,56E-01	4,18E-01
6,95E-01	8,82E-02
2,23E-01	3,07E-02
9,97E-02	5,99E-03



Inverter Switch Characteristics

figure 1. IGBT

Typical output characteristics

$I_C = f(V_{CE})$

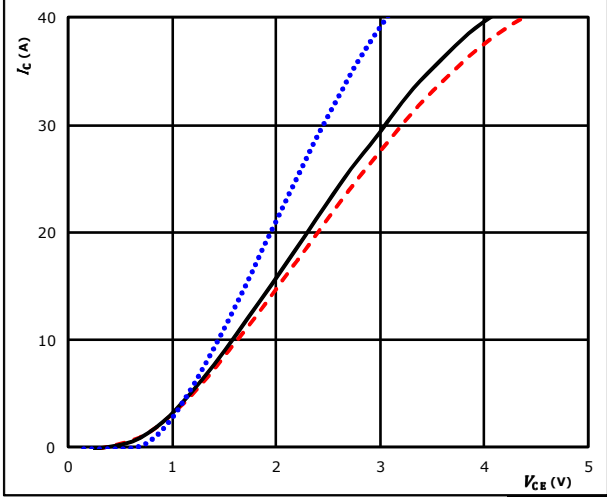

$t_p = 250 \mu s$ $T_j: 25 \text{ }^\circ C$
 $V_{GE} = 15 \text{ V}$ $T_j: 125 \text{ }^\circ C$ ———
 $T_j: 150 \text{ }^\circ C$ - - - - -

figure 2. IGBT

Typical output characteristics

$I_C = f(V_{CE})$

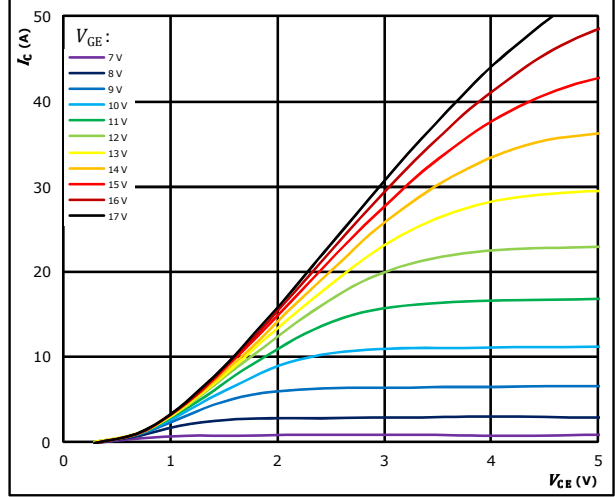

$t_p = 250 \mu s$
 $T_j = 150 \text{ }^\circ C$
 V_{GE} from 7 V to 17 V in steps of 1 V

figure 3. IGBT

Typical transfer characteristics

$I_C = f(V_{GE})$

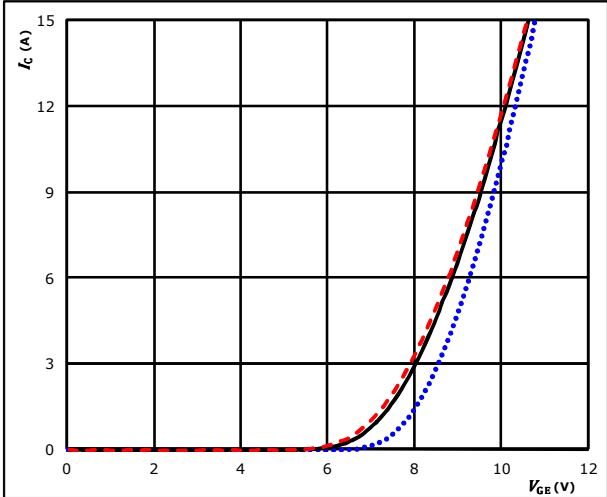

$t_p = 100 \mu s$ $T_j: 25 \text{ }^\circ C$
 $V_{CE} = 10 \text{ V}$ $T_j: 125 \text{ }^\circ C$ ———
 $T_j: 150 \text{ }^\circ C$ - - - - -

figure 4. IGBT

Transient thermal impedance as function of pulse duration

$Z_{th(j-s)} = f(t_p)$

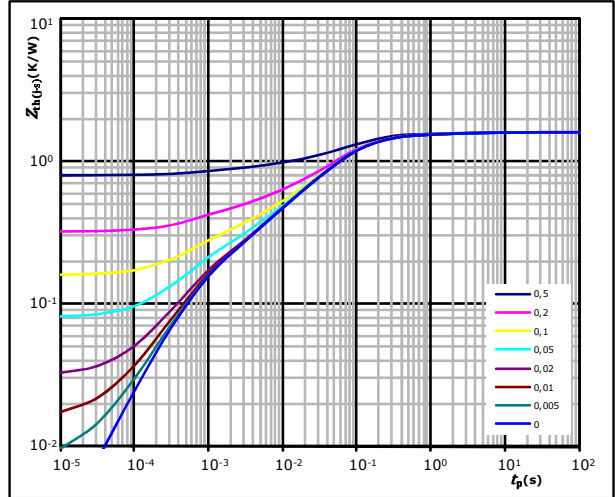

$D = t_p / T$
 $R_{th(j-s)} = 1,60 \text{ K/W}$

IGBT thermal model values

R (K/W)	τ (s)
4,90E-02	4,40E+00
1,40E-01	5,34E-01
8,04E-01	8,02E-02
2,98E-01	2,57E-02
1,69E-01	5,09E-03
1,35E-01	6,41E-04



Inverter Switch Characteristics

figure 5. IGBT

Safe operating area

$I_C = f(V_{CE})$

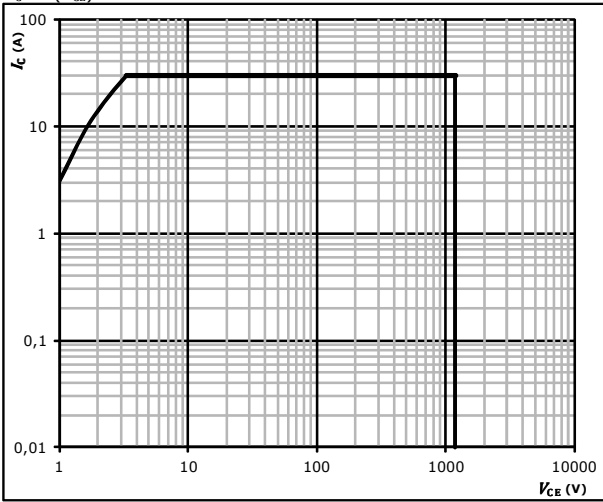

- $D =$ single pulse
- $T_s =$ 80 °C
- $V_{GE} =$ ±15 V
- $T_j = T_{jmax}$



Inverter Diode Characteristics

figure 1. FWD

Typical forward characteristics

$$I_F = f(V_F)$$

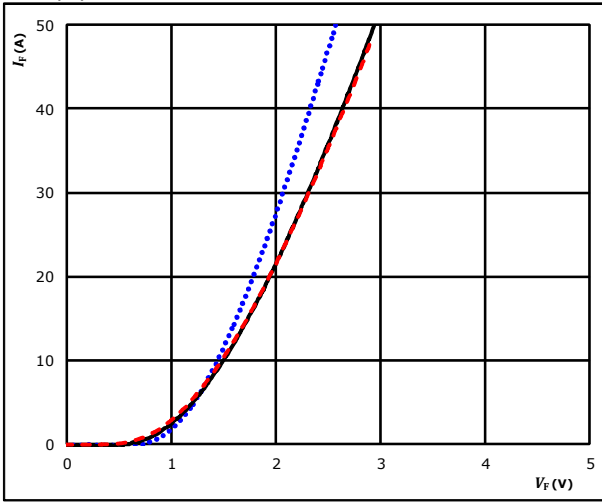

$t_p =$ 250 μs
 T_j : 25 °C
 125 °C ———
 150 °C - - - -

figure 2. FWD

Transient thermal impedance as a function of pulse width

$$Z_{th(j-s)} = f(t_p)$$

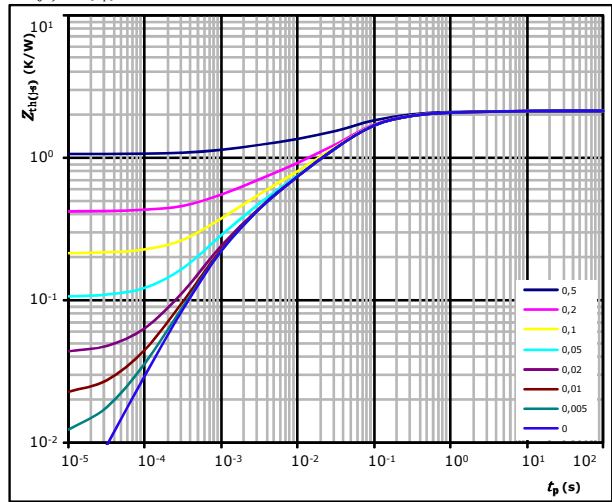

$D = t_p / T$
 $R_{th(j-s)} = 2,11$ K/W
 FWD thermal model values

R (K/W)	τ (s)
8,99E-02	2,33E+00
4,04E-01	1,91E-01
1,05E+00	4,49E-02
3,39E-01	6,08E-03
2,29E-01	1,02E-03



Brake Switch Characteristics

figure 1. IGBT

Typical output characteristics

$$I_C = f(V_{CE})$$

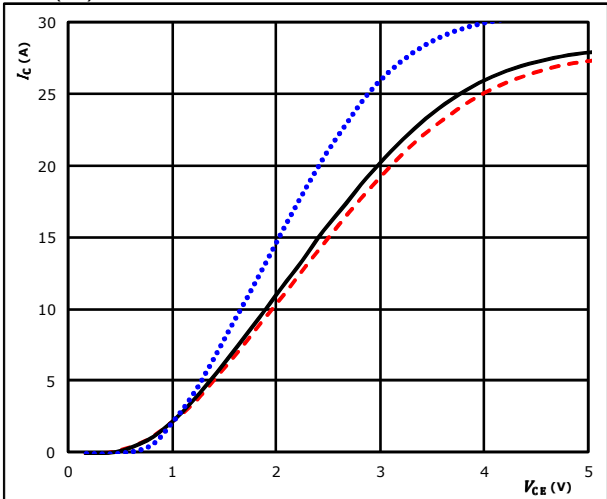

$t_p = 250 \mu s$ $T_j: 25 \text{ }^\circ C$
 $V_{GE} = 15 V$ $T_j: 125 \text{ }^\circ C$ ———
 $T_j: 150 \text{ }^\circ C$ - - - - -

figure 2. IGBT

Typical output characteristics

$$I_C = f(V_{CE})$$

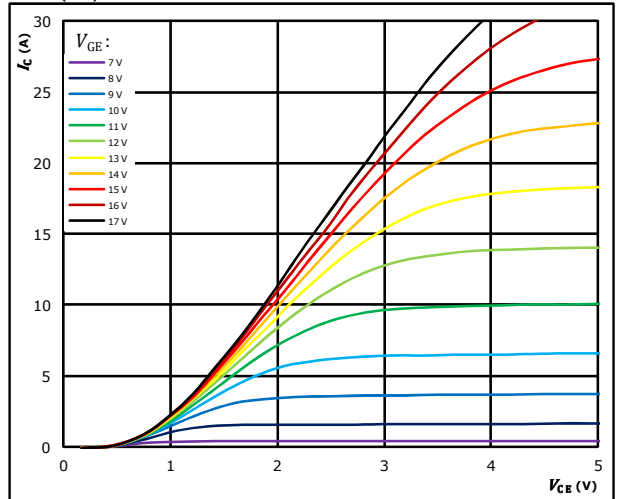

$t_p = 250 \mu s$ $T_j = 150 \text{ }^\circ C$
 V_{GE} from 7 V to 17 V in steps of 1 V

figure 3. IGBT

Typical transfer characteristics

$$I_C = f(V_{GE})$$

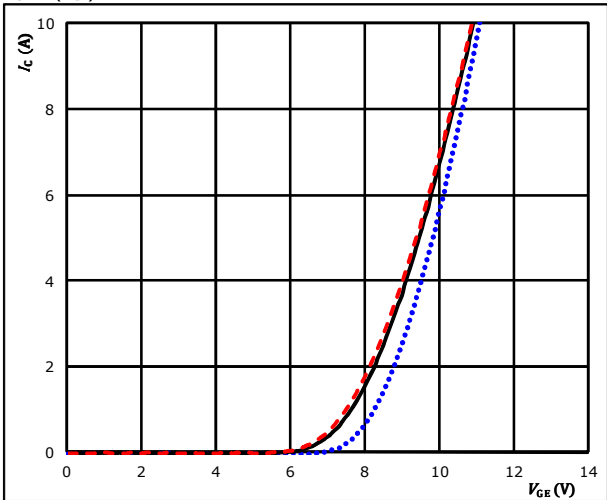

$t_p = 100 \mu s$ $T_j: 25 \text{ }^\circ C$
 $V_{CE} = 10 V$ $T_j: 125 \text{ }^\circ C$ ———
 $T_j: 150 \text{ }^\circ C$ - - - - -

figure 4. IGBT

Transient thermal impedance as function of pulse duration

$$Z_{th(\theta-s)} = f(t_p)$$

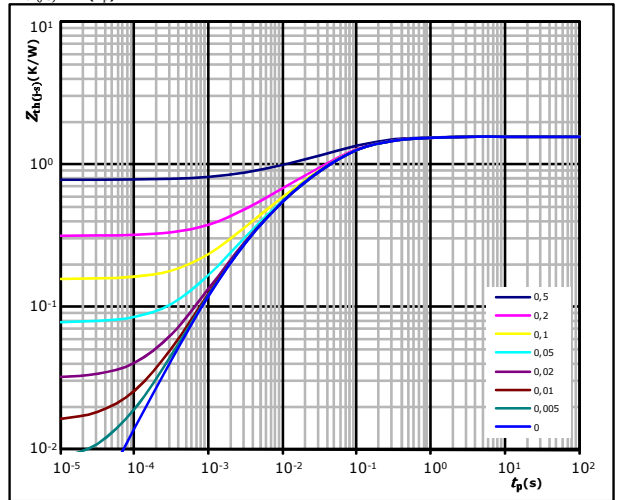

$D = t_p / T$
 $R_{th(\theta-s)} = 1,57 \text{ K/W}$

IGBT thermal model values

R (K/W)	τ (s)
1,42E-01	5,98E-01
6,32E-01	7,71E-02
3,98E-01	2,43E-02
2,86E-01	6,16E-03
1,08E-01	1,44E-03



Brake Switch Characteristics

figure 5. IGBT

Safe operating area

$I_C = f(V_{CE})$

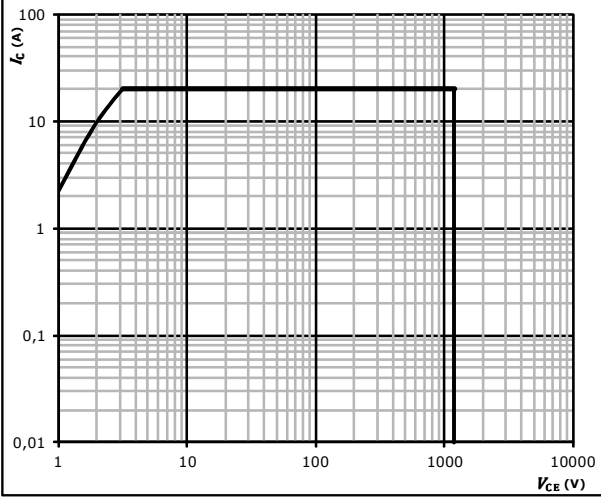

- $D =$ single pulse
- $T_s =$ 80 °C
- $V_{GE} =$ ±15 V
- $T_j = T_{jmax}$



Brake Diode Characteristics

figure 1. FWD

Typical forward characteristics

$$I_F = f(V_F)$$

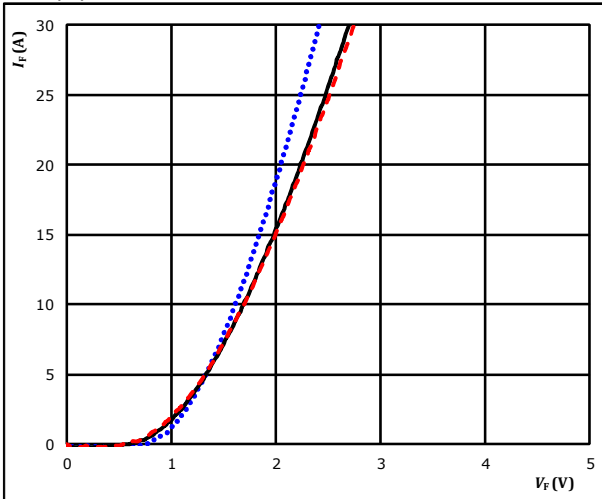

$t_p = 250 \mu s$ T_j : 25 °C (blue dotted line), 125 °C (black solid line), 150 °C (red dashed line)

figure 2. FWD

Transient thermal impedance as a function of pulse width

$$Z_{th(j-s)} = f(t_p)$$

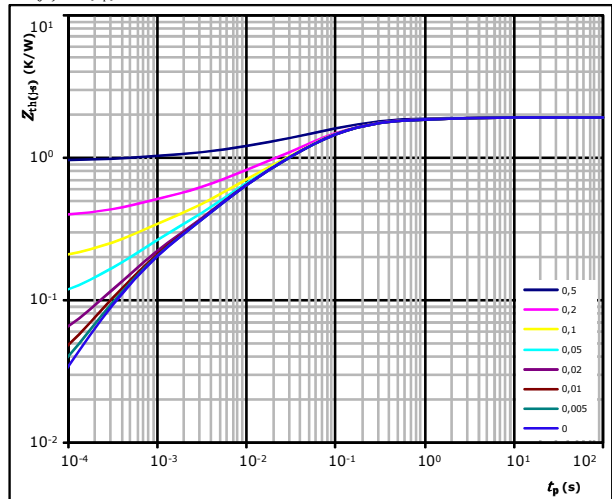

$D = t_p / T$
 $R_{th(j-s)} = 1,91 \text{ K/W}$
 FWD thermal model values

R (K/W)	τ (s)
9,38E-02	2,25E+00
3,43E-01	2,12E-01
8,53E-01	5,82E-02
3,59E-01	9,80E-03
1,37E-01	2,88E-03
1,26E-01	4,78E-04

Thermistor Characteristics

figure 1. Thermistor

Typical NTC characteristic as a function of temperature

$$R = f(T)$$

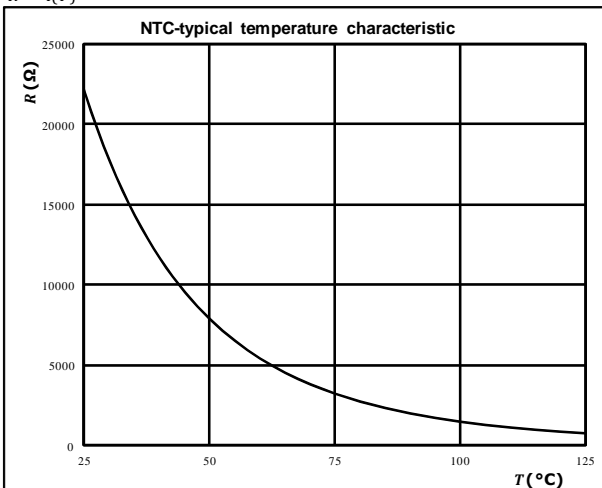



Inverter Switching Characteristics

figure 1. IGBT

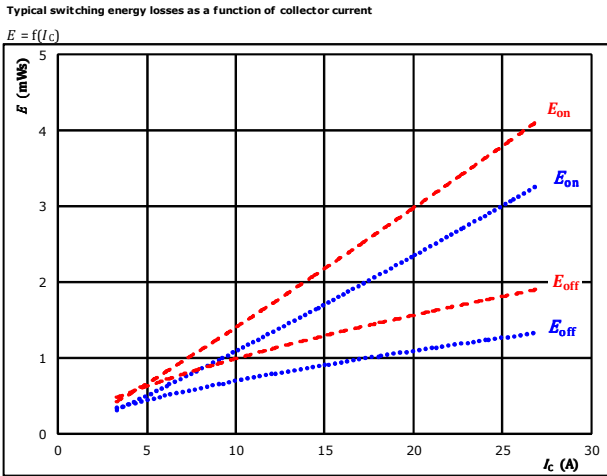

With an inductive load at

$V_{CE} = 600$ V	$T_j: 25$ °C
$V_{GE} = \pm 15$ V	150 °C	-----
$R_{gon} = 32$ Ω		
$R_{goff} = 32$ Ω		

figure 2. IGBT

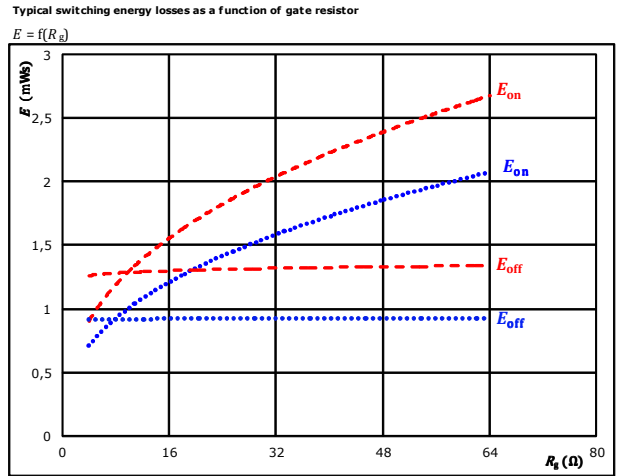

With an inductive load at

$V_{CE} = 600$ V	$T_j: 25$ °C
$V_{GE} = \pm 15$ V	150 °C	-----
$I_C = 15$ A		

figure 3. FWD

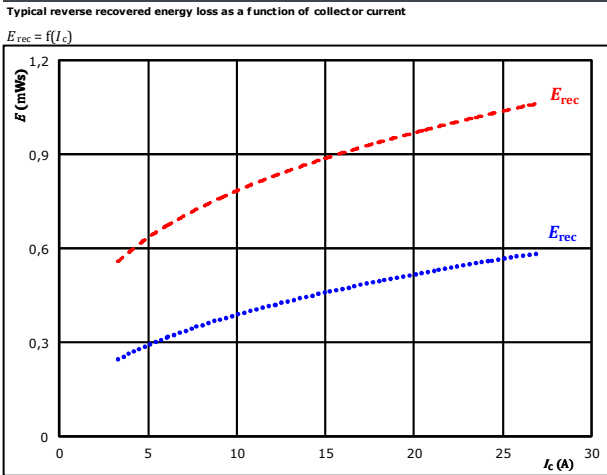

With an inductive load at

$V_{CE} = 600$ V	$T_j: 25$ °C
$V_{GE} = \pm 15$ V	150 °C	-----
$R_{gon} = 32$ Ω		

figure 4. FWD

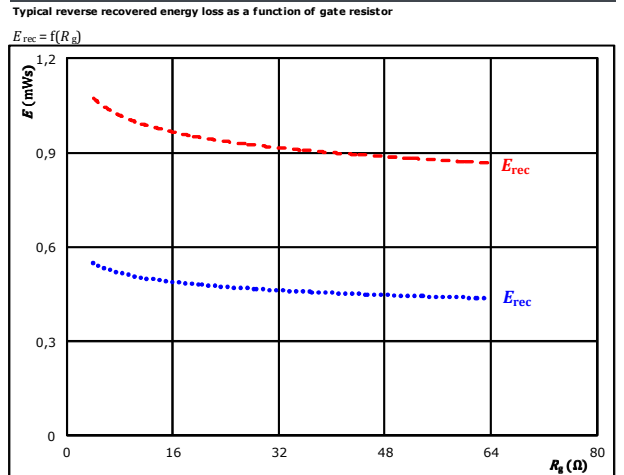

With an inductive load at

$V_{CE} = 600$ V	$T_j: 25$ °C
$V_{GE} = \pm 15$ V	150 °C	-----
$I_C = 15$ A		



Inverter Switching Characteristics

figure 5. IGBT

Typical switching times as a function of collector current

$$t = f(I_C)$$

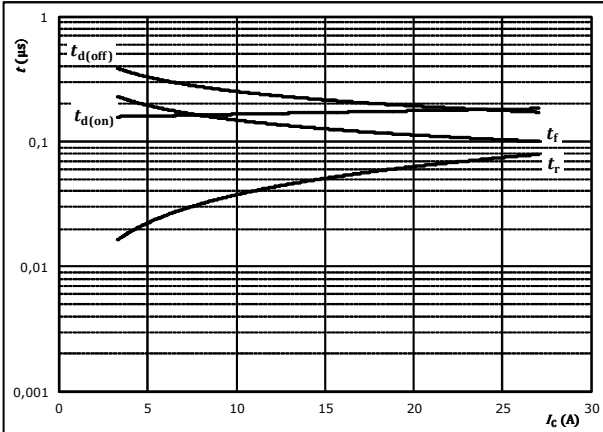

With an inductive load at

$T_j =$	150	°C
$V_{CE} =$	600	V
$V_{GE} =$	±15	V
$R_{gon} =$	32	Ω
$R_{goff} =$	32	Ω

figure 6. IGBT

Typical switching times as a function of gate resistor

$$t = f(R_g)$$

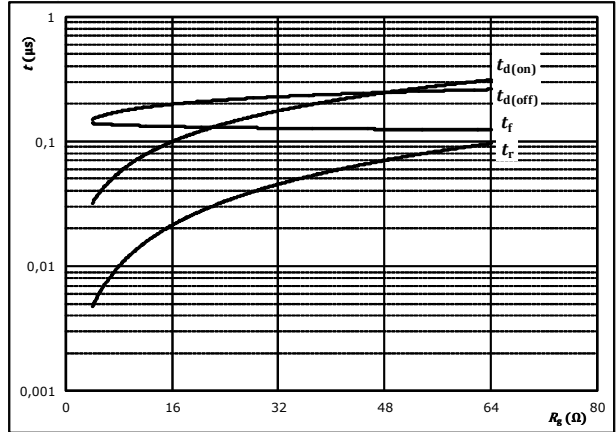

With an inductive load at

$T_j =$	150	°C
$V_{CE} =$	600	V
$V_{GE} =$	±15	V
$I_C =$	15	A

figure 7. FWD

Typical reverse recovery time as a function of collector current

$$t_{rr} = f(I_C)$$

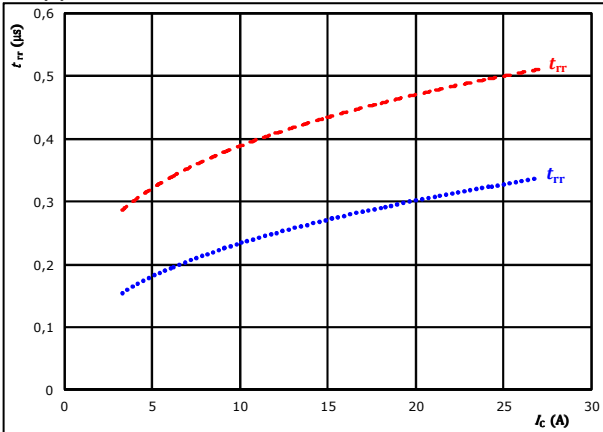

At	$V_{CE} =$	600	V	$T_j =$	25 °C
	$V_{GE} =$	±15	V		150 °C	-----
	$R_{gon} =$	32	Ω			

figure 8. FWD

Typical reverse recovery time as a function of IGBT turn on gate resistor

$$t_{rr} = f(R_{gon})$$

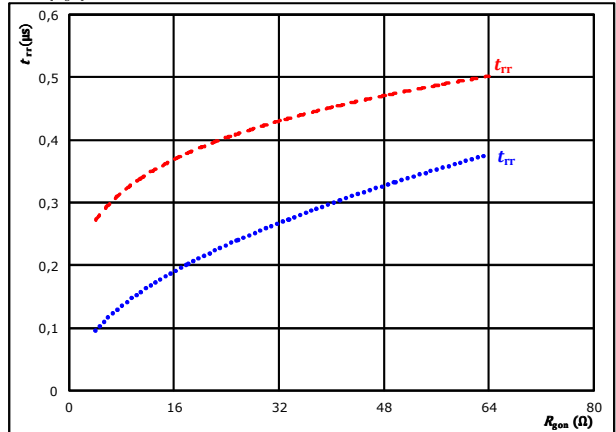

At	$V_{CE} =$	600	V	$T_j =$	25 °C
	$V_{GE} =$	±15	V		150 °C	-----
	$I_C =$	15	A			



Inverter Switching Characteristics

figure 9. FWD

Typical recovered charge as a function of collector current

$$Q_r = f(I_c)$$

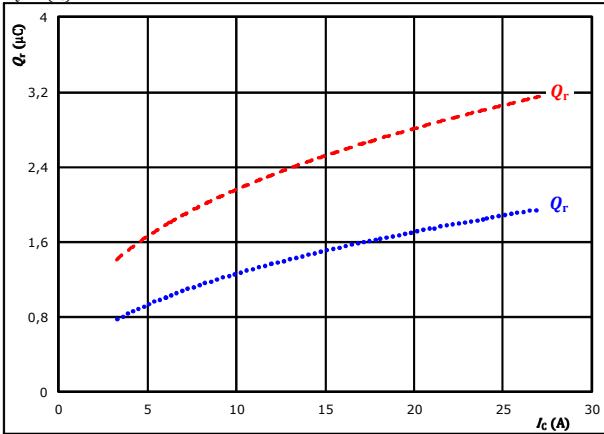

At $V_{CE} = 600$ V
 $V_{GE} = \pm 15$ V
 $R_{gdn} = 32$ Ω
 $T_j: 25$ °C (blue dotted line)
 150 °C (red dashed line)

figure 10. FWD

Typical recovered charge as a function of IGBT turn on gate resistor

$$Q_r = f(R_{gdn})$$

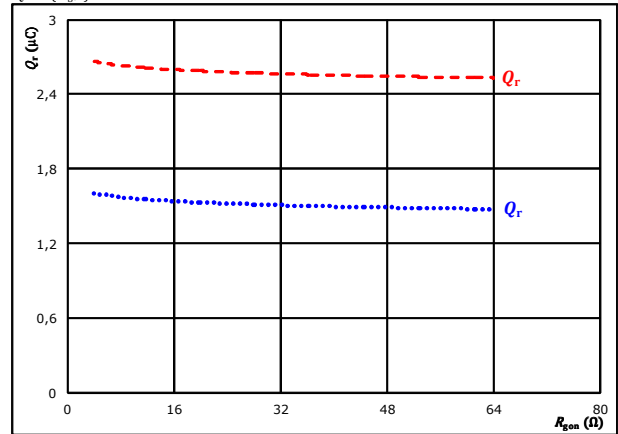

At $V_{CE} = 600$ V
 $V_{GE} = \pm 15$ V
 $I_c = 15$ A
 $T_j: 25$ °C (blue dotted line)
 150 °C (red dashed line)

figure 11. FWD

Typical peak reverse recovery current current as a function of collector current

$$I_{RM} = f(I_c)$$

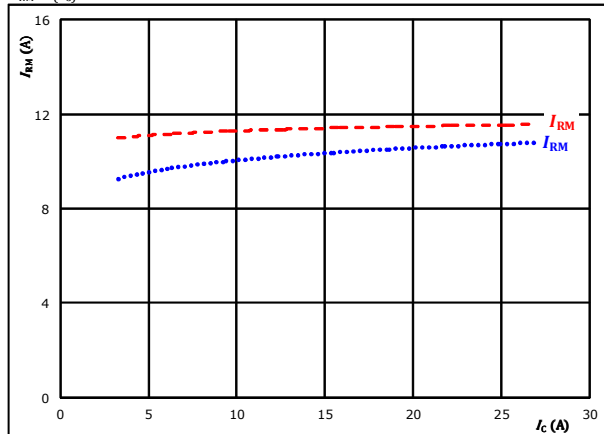

At $V_{CE} = 600$ V
 $V_{GE} = \pm 15$ V
 $R_{gdn} = 32$ Ω
 $T_j: 25$ °C (blue dotted line)
 150 °C (red dashed line)

figure 12. FWD

Typical peak reverse recovery current as a function of IGBT turn on gate resistor

$$I_{RM} = f(R_{gdn})$$

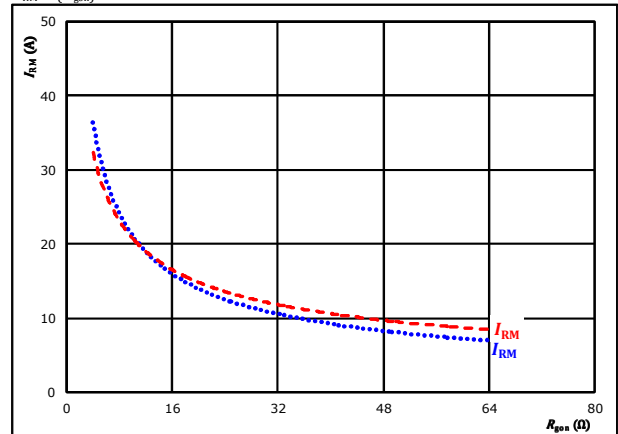

At $V_{CE} = 600$ V
 $V_{GE} = \pm 15$ V
 $I_c = 15$ A
 $T_j: 25$ °C (blue dotted line)
 150 °C (red dashed line)



Inverter Switching Characteristics

figure 13. FWD

Typical rate of fall of forward and reverse recovery current as a function of collector current
 $di_f/dt, di_{rr}/dt = f(I_c)$

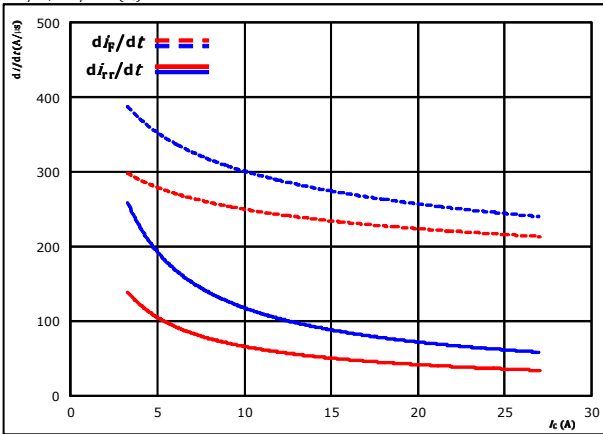

At $V_{CE} = 600$ V $T_j = 25$ °C (solid blue), 150 °C (dashed red)
 $V_{GE} = \pm 15$ V
 $R_{g(on)} = 32$ Ω

figure 14. FWD

Typical rate of fall of forward and reverse recovery current as a function of IGBT turn on gate resistor
 $di_f/dt, di_{rr}/dt = f(R_{g(on)})$

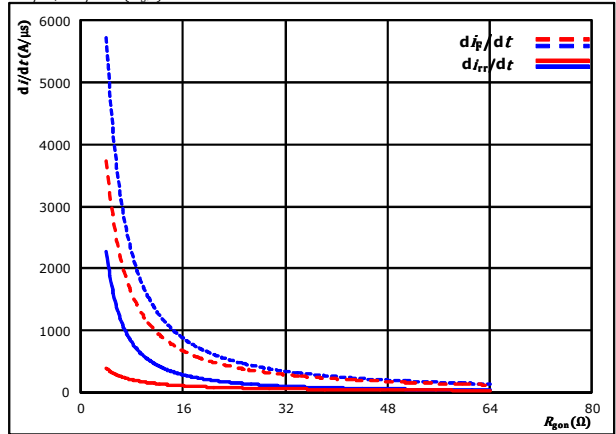

At $V_{CE} = 600$ V $T_j = 25$ °C (solid blue), 150 °C (dashed red)
 $V_{GE} = \pm 15$ V
 $I_c = 15$ A

figure 15. IGBT

Reverse bias safe operating area
 $I_c = f(V_{CB})$

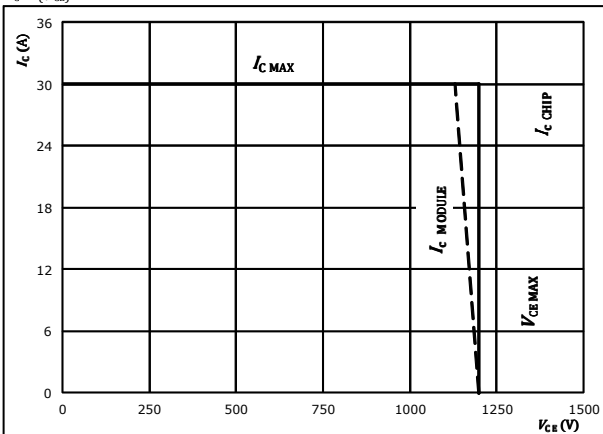

At $T_j = 175$ °C
 $R_{g(on)} = 32$ Ω
 $R_{g(off)} = 32$ Ω



Inverter Switching Definitions

General conditions

T_j	=	150 °C
R_{gon}	=	32 Ω
R_{goff}	=	32 Ω

figure 1. IGBT

Turn-off Switching Waveforms & definition of t_{doff} , t_{eff} (t_{Eoff} = integrating time for E_{off})

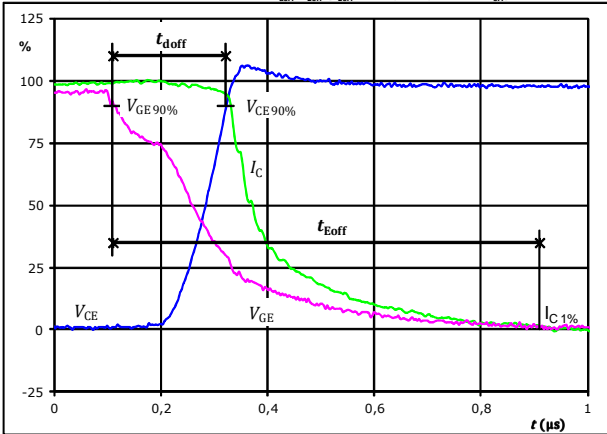

$V_{CE}(0\%) =$	-15	V
$V_{GE}(100\%) =$	15	V
$V_C(100\%) =$	600	V
$I_C(100\%) =$	15	A
$t_{doff} =$	0,218	μs
$t_{Eoff} =$	0,800	μs

figure 2. IGBT

Turn-on Switching Waveforms & definition of t_{don} , t_{Eon} (t_{Eon} = integrating time for E_{on})

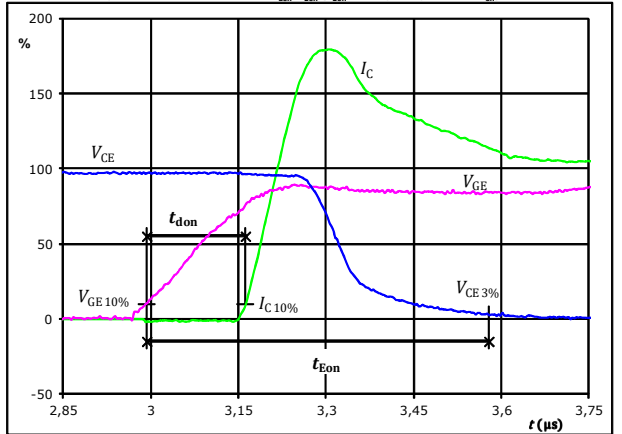

$V_{CE}(0\%) =$	-15	V
$V_{GE}(100\%) =$	15	V
$V_C(100\%) =$	600	V
$I_C(100\%) =$	15	A
$t_{don} =$	0,174	μs
$t_{Eon} =$	0,586	μs

figure 3. IGBT

Turn-off Switching Waveforms & definition of t_f

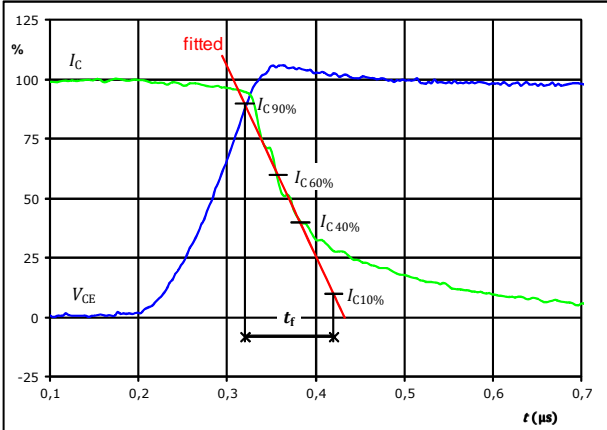

$V_C(100\%) =$	600	V
$I_C(100\%) =$	15	A
$t_f =$	0,127	μs

figure 4. IGBT

Turn-on Switching Waveforms & definition of t_r

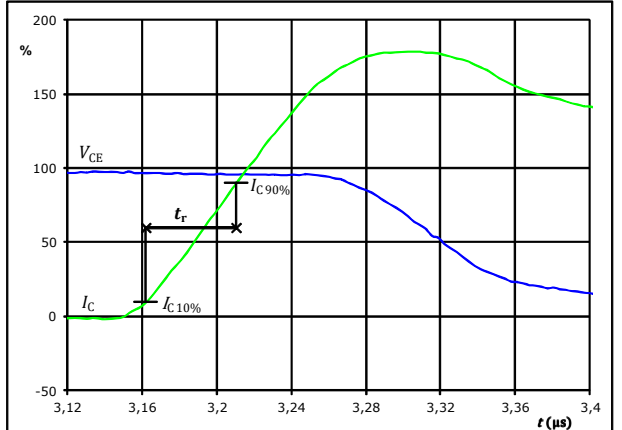

$V_C(100\%) =$	600	V
$I_C(100\%) =$	15	A
$t_r =$	0,048	μs



Vincotech

10-FY12PMA015M7-P587A78
10-PY12PMA015M7-P587A78Y
10-F112PMA015M7-P587A79
 datasheet

Inverter Switching Characteristics

figure 5. IGBT

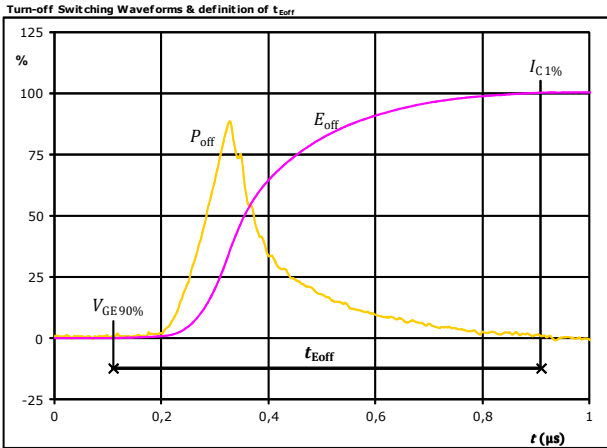

$P_{off}(100\%) = 9,24$ kW
 $E_{off}(100\%) = 1,32$ mJ
 $t_{Eoff} = 0,80$ μ s

figure 6. IGBT

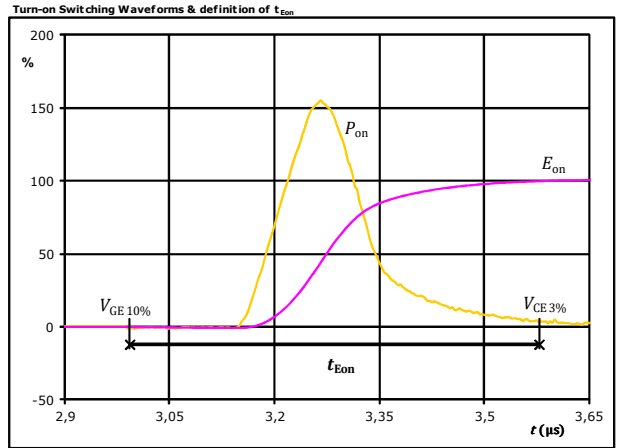

$P_{on}(100\%) = 9,24$ kW
 $E_{on}(100\%) = 2,01$ mJ
 $t_{Eon} = 0,59$ μ s

figure 7. FWD

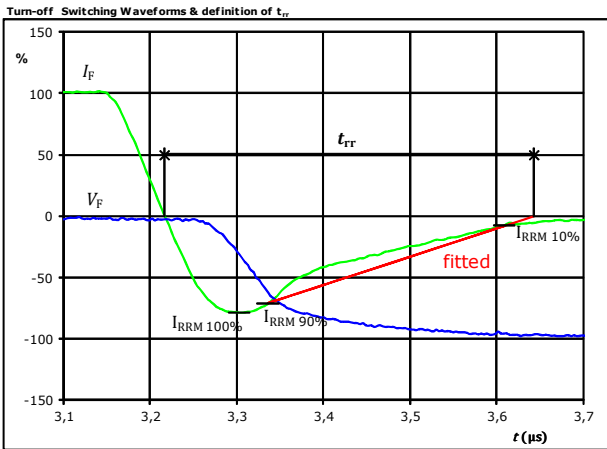

$V_F(100\%) = 600$ V
 $I_F(100\%) = 15$ A
 $I_{RRM}(100\%) = -12$ A
 $t_{rr} = 0,423$ μ s



Inverter Switching Characteristics

figure 8. FWD

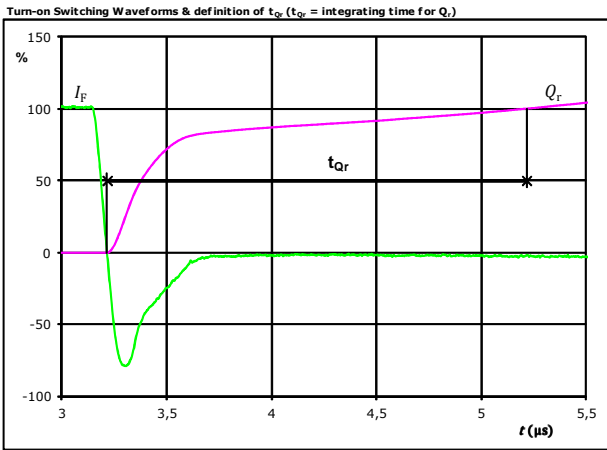

I_F (100%) =	15	A
Q_r (100%) =	2,59	μC
t_{Qr} =	2,00	μs

figure 9. FWD

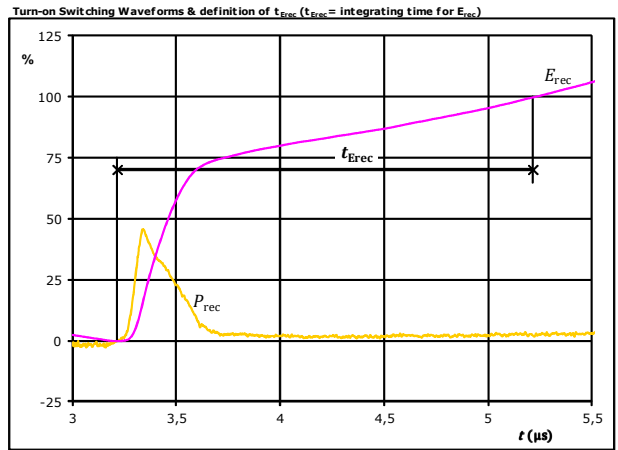

P_{rec} (100%) =	9,24	kW
E_{rec} (100%) =	0,94	mJ
t_{Erec} =	2,00	μs



Brake Switching Characteristics

figure 1. IGBT

Typical switching energy losses as a function of collector current

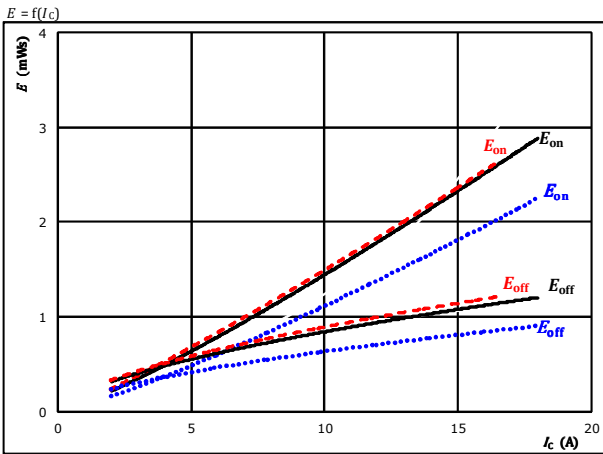

With an inductive load at
 $V_{CE} = 600$ V
 $V_{GE} = 15/0$ V
 $R_{gon} = 32$ Ω
 $R_{goff} = 32$ Ω

T_j : 25 °C (dotted blue), 125 °C (solid black), 150 °C (dashed red)

figure 2. IGBT

Typical switching energy losses as a function of gate resistor

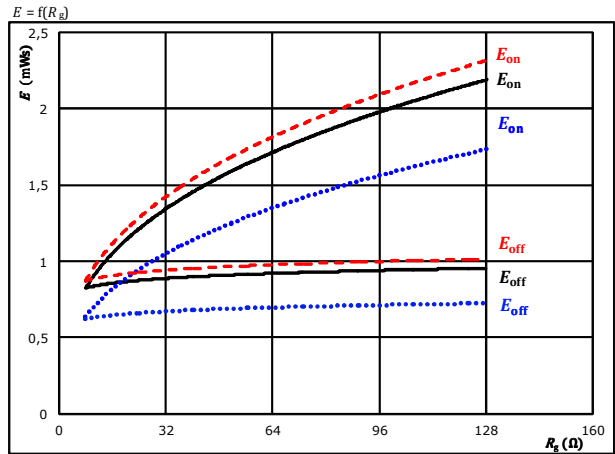

With an inductive load at
 $V_{CE} = 600$ V
 $V_{GE} = 15/0$ V
 $I_C = 10$ A

T_j : 25 °C (dotted blue), 125 °C (solid black), 150 °C (dashed red)

figure 3. FWD

Typical reverse recovered energy loss as a function of collector current

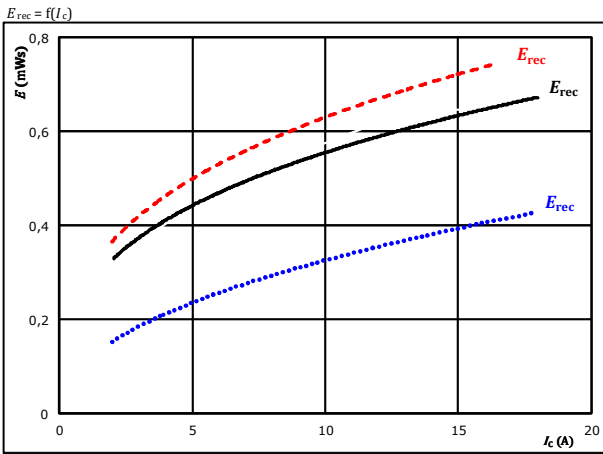

With an inductive load at
 $V_{CE} = 600$ V
 $V_{GE} = 15/0$ V
 $R_{gon} = 32$ Ω

T_j : 25 °C (dotted blue), 125 °C (solid black), 150 °C (dashed red)

figure 4. FWD

Typical reverse recovered energy loss as a function of gate resistor

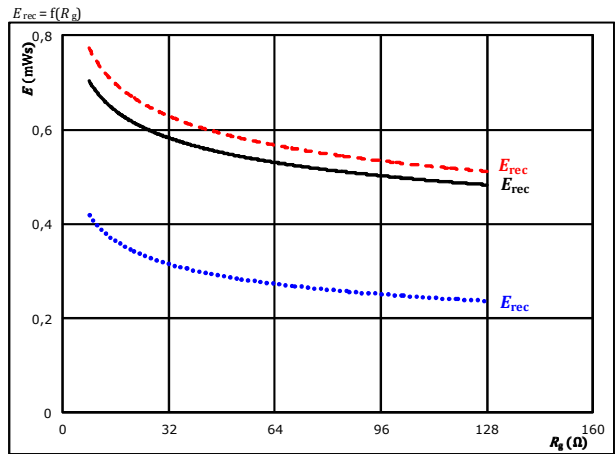

With an inductive load at
 $V_{CE} = 600$ V
 $V_{GE} = 15/0$ V
 $I_C = 10$ A

T_j : 25 °C (dotted blue), 125 °C (solid black), 150 °C (dashed red)



Brake Switching Characteristics

figure 5. IGBT

Typical switching times as a function of collector current

$$t = f(I_c)$$

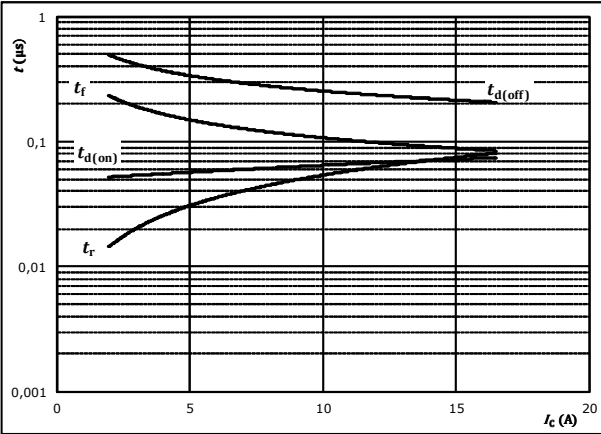

With an inductive load at

$T_j =$	150	°C
$V_{CE} =$	600	V
$V_{GE} =$	15/0	V
$R_{gon} =$	32	Ω
$R_{goff} =$	32	Ω

figure 6. IGBT

Typical switching times as a function of gate resistor

$$t = f(R_g)$$

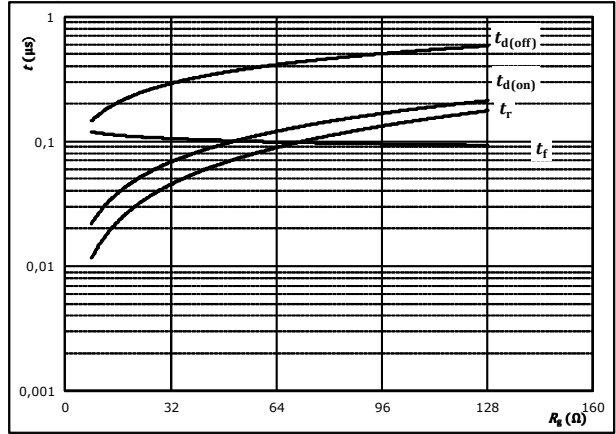

With an inductive load at

$T_j =$	150	°C
$V_{CE} =$	600	V
$V_{GE} =$	15/0	V
$I_c =$	10	A

figure 7. FWD

Typical reverse recovery time as a function of collector current

$$t_{rr} = f(I_c)$$

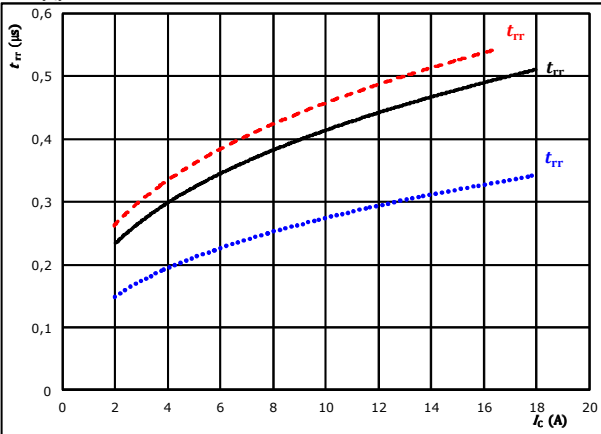

At	$V_{CE} =$	600	V	$T_j:$	25 °C
	$V_{GE} =$	15/0	V		125 °C	————
	$R_{gon} =$	32	Ω		150 °C	-----

figure 8. FWD

Typical reverse recovery time as a function of IGBT turn on gate resistor

$$t_{rr} = f(R_{gon})$$

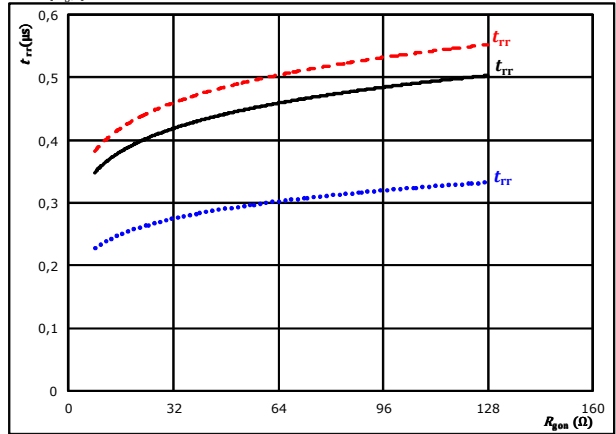

At	$V_{CE} =$	600	V	$T_j:$	25 °C
	$V_{GE} =$	15/0	V		125 °C	————
	$I_c =$	10	A		150 °C	-----



Brake Switching Characteristics

figure 9. FWD

Typical recovered charge as a function of collector current

$$Q_r = f(I_c)$$

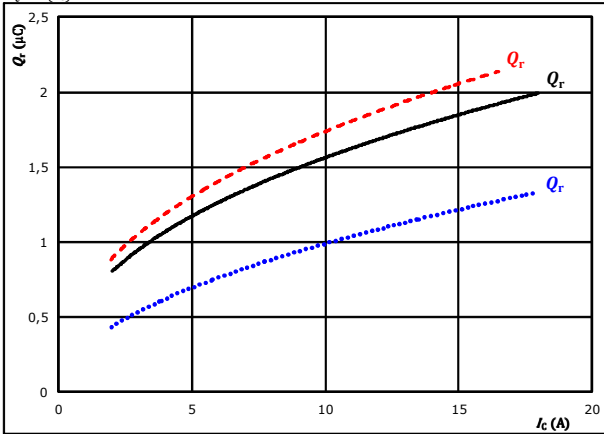

At $V_{CE} = 600$ V $T_j: 25$ °C
 $V_{GE} = 15/0$ V $T_j: 125$ °C ———
 $R_{gpn} = 32$ Ω $T_j: 150$ °C - - - - -

figure 10. FWD

Typical recovered charge as a function of IGBT turn on gate resistor

$$Q_r = f(R_{gpn})$$

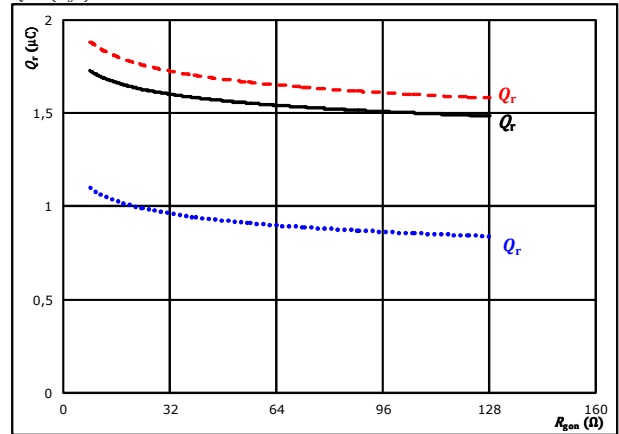

At $V_{CE} = 600$ V $T_j: 25$ °C
 $V_{GE} = 15/0$ V $T_j: 125$ °C ———
 $I_c = 10$ A $T_j: 150$ °C - - - - -

figure 11. FWD

Typical peak reverse recovery current current as a function of collector current

$$I_{RM} = f(I_c)$$

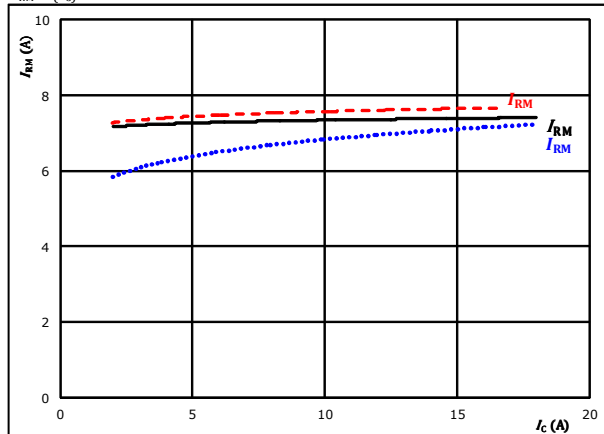

At $V_{CE} = 600$ V $T_j: 25$ °C
 $V_{GE} = 15/0$ V $T_j: 125$ °C ———
 $R_{gpn} = 32$ Ω $T_j: 150$ °C - - - - -

figure 12. FWD

Typical peak reverse recovery current current as a function of IGBT turn on gate resistor

$$I_{RM} = f(R_{gpn})$$

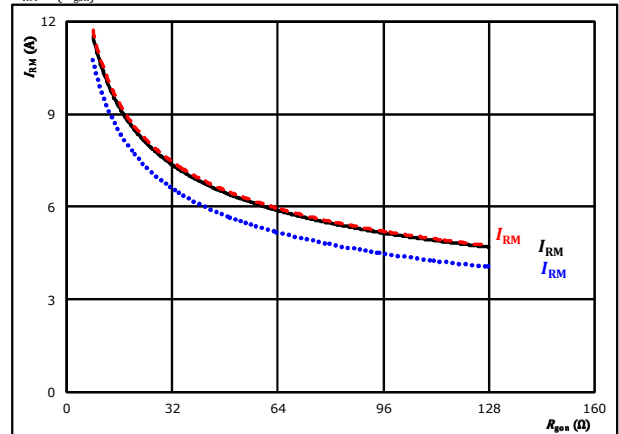

At $V_{CE} = 600$ V $T_j: 25$ °C
 $V_{GE} = 15/0$ V $T_j: 125$ °C ———
 $I_c = 10$ A $T_j: 150$ °C - - - - -



Brake Switching Characteristics

figure 13. FWD

Typical rate of fall of forward and reverse recovery current as a function of collector current
 $di_f/dt, di_{rr}/dt = f(I_c)$

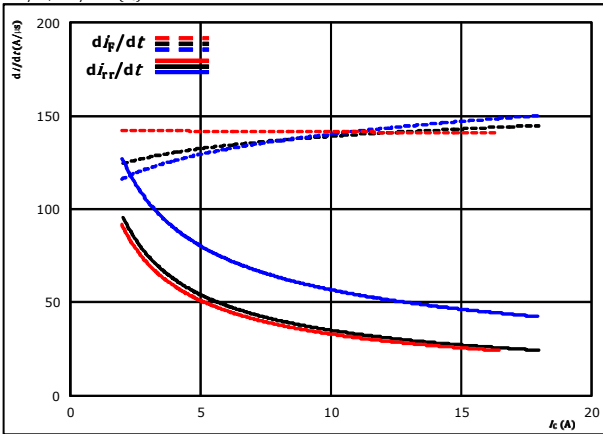

At $V_{CE} = 600$ V $T_j = 25$ °C
 $V_{GE} = 15/0$ V $T_j = 125$ °C ———
 $R_{gpn} = 32$ Ω $T_j = 150$ °C - - - - -

figure 14. FWD

Typical rate of fall of forward and reverse recovery current as a function of IGBT turn on gate resistor
 $di_f/dt, di_{rr}/dt = f(R_{gpn})$

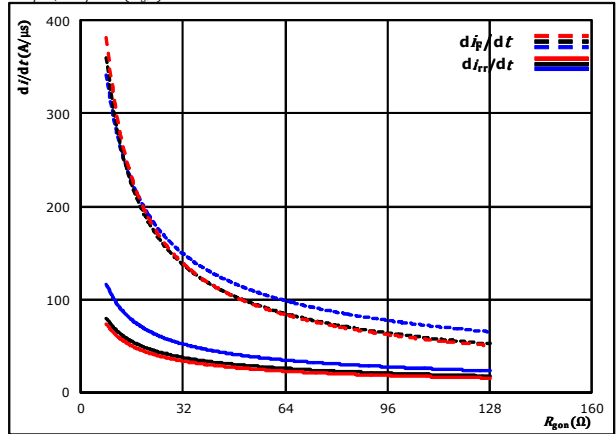

At $V_{CE} = 600$ V $T_j = 25$ °C
 $V_{GE} = 15/0$ V $T_j = 125$ °C ———
 $I_c = 10$ A $T_j = 150$ °C - - - - -

figure 15. IGBT

Reverse bias safe operating area
 $I_c = f(V_{CB})$

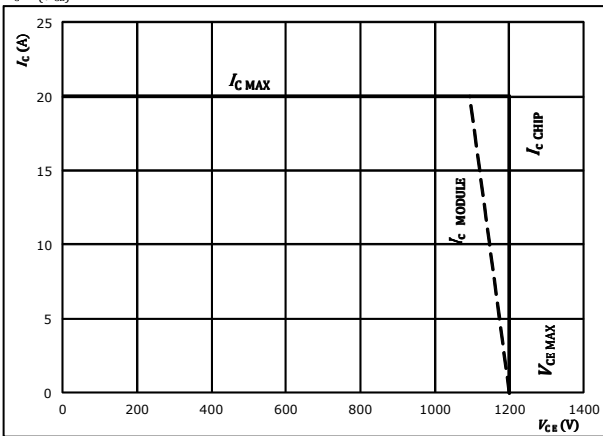

At $T_j = 175$ °C
 $R_{gpn} = 32$ Ω
 $R_{goff} = 32$ Ω



Brake Switching Definitions

General conditions

T_j	=	125 °C
R_{gon}	=	32 Ω
R_{goff}	=	32 Ω

figure 1. IGBT

Turn-off Switching Waveforms & definition of t_{doff} , t_{Eoff} (t_{Eoff} = integrating time for E_{off})

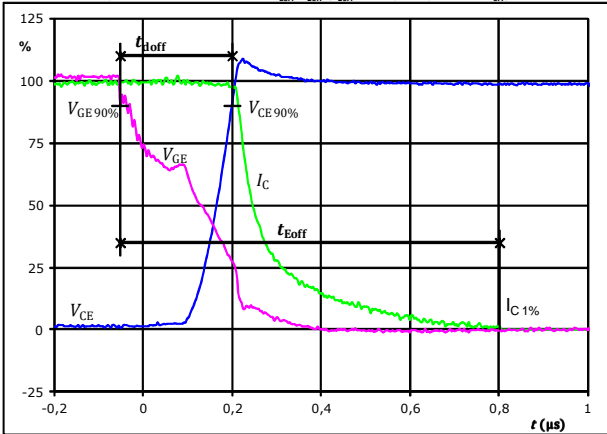

$V_{GE}(0\%) =$	0	V
$V_{GE}(100\%) =$	15	V
$V_C(100\%) =$	600	V
$I_C(100\%) =$	10	A
$t_{doff} =$	0,251	µs
$t_{Eoff} =$	0,853	µs

figure 2. IGBT

Turn-on Switching Waveforms & definition of t_{don} , t_{Eon} (t_{Eon} = integrating time for E_{on})

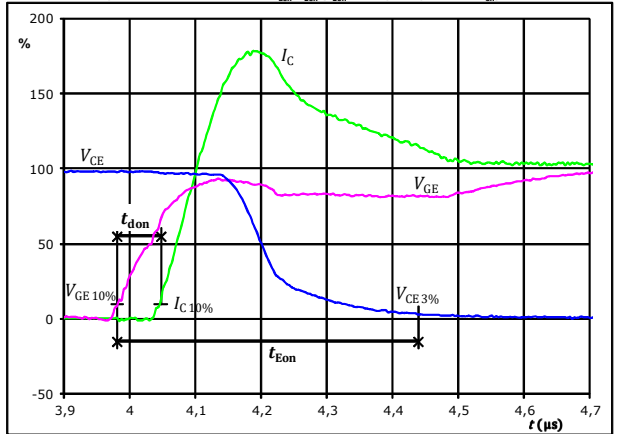

$V_{GE}(0\%) =$	0	V
$V_{GE}(100\%) =$	15	V
$V_C(100\%) =$	600	V
$I_C(100\%) =$	10	A
$t_{don} =$	0,068	µs
$t_{Eon} =$	0,458	µs

figure 3. IGBT

Turn-off Switching Waveforms & definition of t_f

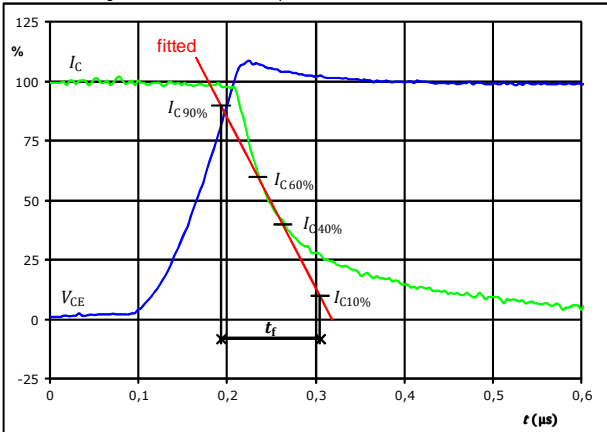

$V_C(100\%) =$	600	V
$I_C(100\%) =$	10	A
$t_f =$	0,111	µs

figure 4. IGBT

Turn-on Switching Waveforms & definition of t_r

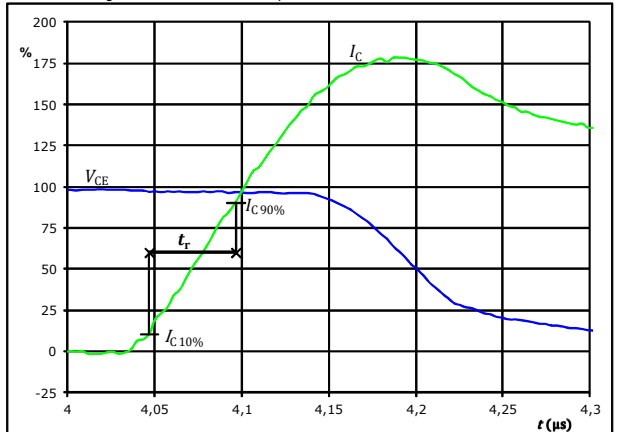

$V_C(100\%) =$	600	V
$I_C(100\%) =$	10	A
$t_r =$	0,050	µs



Vincotech

10-FY12PMA015M7-P587A78
10-PY12PMA015M7-P587A78Y
10-F112PMA015M7-P587A79
 datasheet

Brake Switching Characteristics

figure 5. IGBT

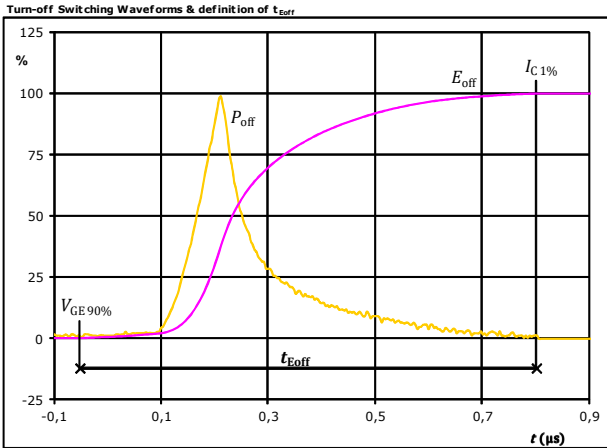

$P_{\text{off}}(100\%) = 6,03$ kW
 $E_{\text{off}}(100\%) = 0,86$ mJ
 $t_{\text{Eoff}} = 0,85$ µs

figure 6. IGBT

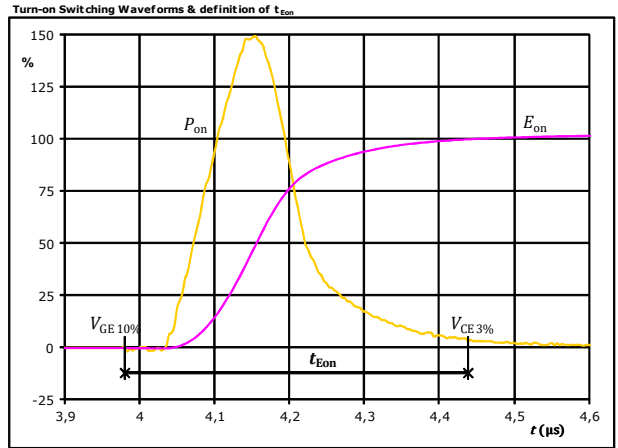

$P_{\text{on}}(100\%) = 6,03$ kW
 $E_{\text{on}}(100\%) = 1,25$ mJ
 $t_{\text{Eon}} = 0,46$ µs

figure 7. FWD

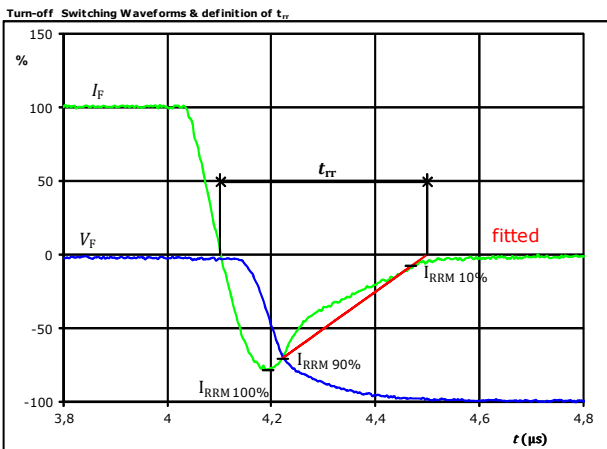

$V_{\text{F}}(100\%) = 600$ V
 $I_{\text{F}}(100\%) = 10$ A
 $I_{\text{RRM}}(100\%) = -8$ A
 $t_{\text{rr}} = 0,396$ µs



Brake Switching Characteristics

figure 8. FWD

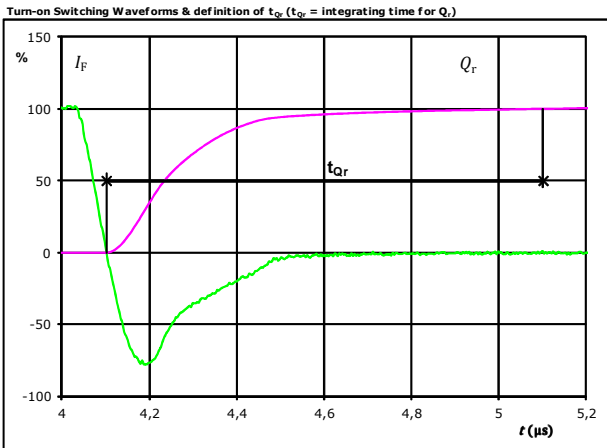

I_F (100%) =	10	A
Q_r (100%) =	1,57	μC
t_{Qr} =	1,00	μs

figure 9. FWD

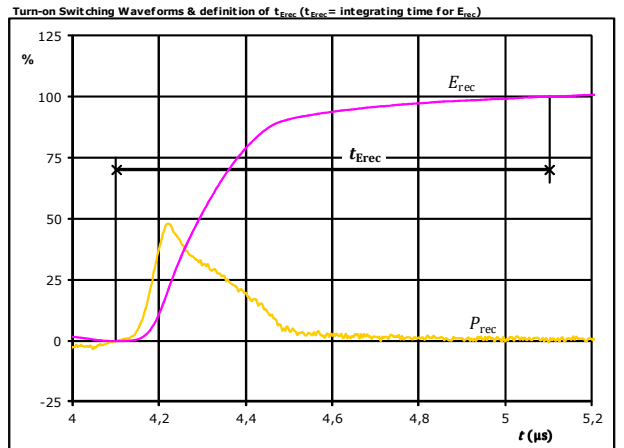

P_{rec} (100%) =	6,03	kW
E_{rec} (100%) =	0,58	mJ
t_{Erec} =	1,00	μs



Vincotech

10-FY12PMA015M7-P587A78
10-PY12PMA015M7-P587A78Y
10-F112PMA015M7-P587A79
 datasheet

Ordering Code & Marking									
Version			Ordering Code						
without thermal paste 12 mm housing with solder pins			10-FY12PMA015M7-P587A78						
with thermal paste 12 mm housing with press-fit pins			10-PY12PMA015M7-P587A78Y-/3/						
without thermal paste 17 mm housing with solder pins			10-F112PMA015M7-P587A79						
NN-NNNNNNNNNNNN TTTTIV WWYY UL VIN LLLL SSSS			Text		Name	Date code	UL & VIN	Lot	Serial
					NN-NNNNNNNNNNNN-TTTTIV	WWYY	UL VIN	LLLL	SSSS
			Datamatrix	Type&Ver	Lot number	Serial	Date code		
			TTTTIV	LLLL	SSSS	WWYY			

Pin table				Outline	
Pin	X	Y	Function		
1	52,55	0	G27	P587A79	
2	47,7	0	DC-Rect		
3	44,8	0	DC-Rect		
4	37,8	0	DC+Rect		
5	37,8	2,8	DC+Rect	P587A78	
6	35	0	DC+Inv		
7	35	2,8	DC+Inv		
8	28	0	Therm1		
9	25,2	0	Therm2	P587A78Y	
10	22,4	0	DC-3		
11	19,6	0	G15		
12	16,8	0	S15		
13	14	0	DC-2		<p>center of press-fit pinhead for connection parameter see the handling instruction</p>
14	11,2	0	G13		
15	8,4	0	S13		
16	5,6	0	DC-1		
17	2,8	0	G11		
18	0	0	S11		
19	0	28,5	Ph1		
20	2,8	28,5	G12		
21	7,5	28,5	S12		
22	14,5	28,5	Ph2		
23	17,3	28,5	G14		
24	22	28,5	S14		
25	29	28,5	Ph3		
26	31,8	28,5	G16		
27	36,5	28,5	S16		
28	43,5	28,5	ACIn1		
29	52,55	25	ACIn2		
30	52,55	16,9	ACIn3		
31	52,55	8,6	Br		
32	52,55	2,8	DC-Br		

Tolerance of pinpositions: ±0.5mm at the end of pins
 Dimension of coordinate axis is only offset without tolerance



Vincotech

10-FY12PMA015M7-P587A78
10-PY12PMA015M7-P587A78Y
10-F112PMA015M7-P587A79
 datasheet

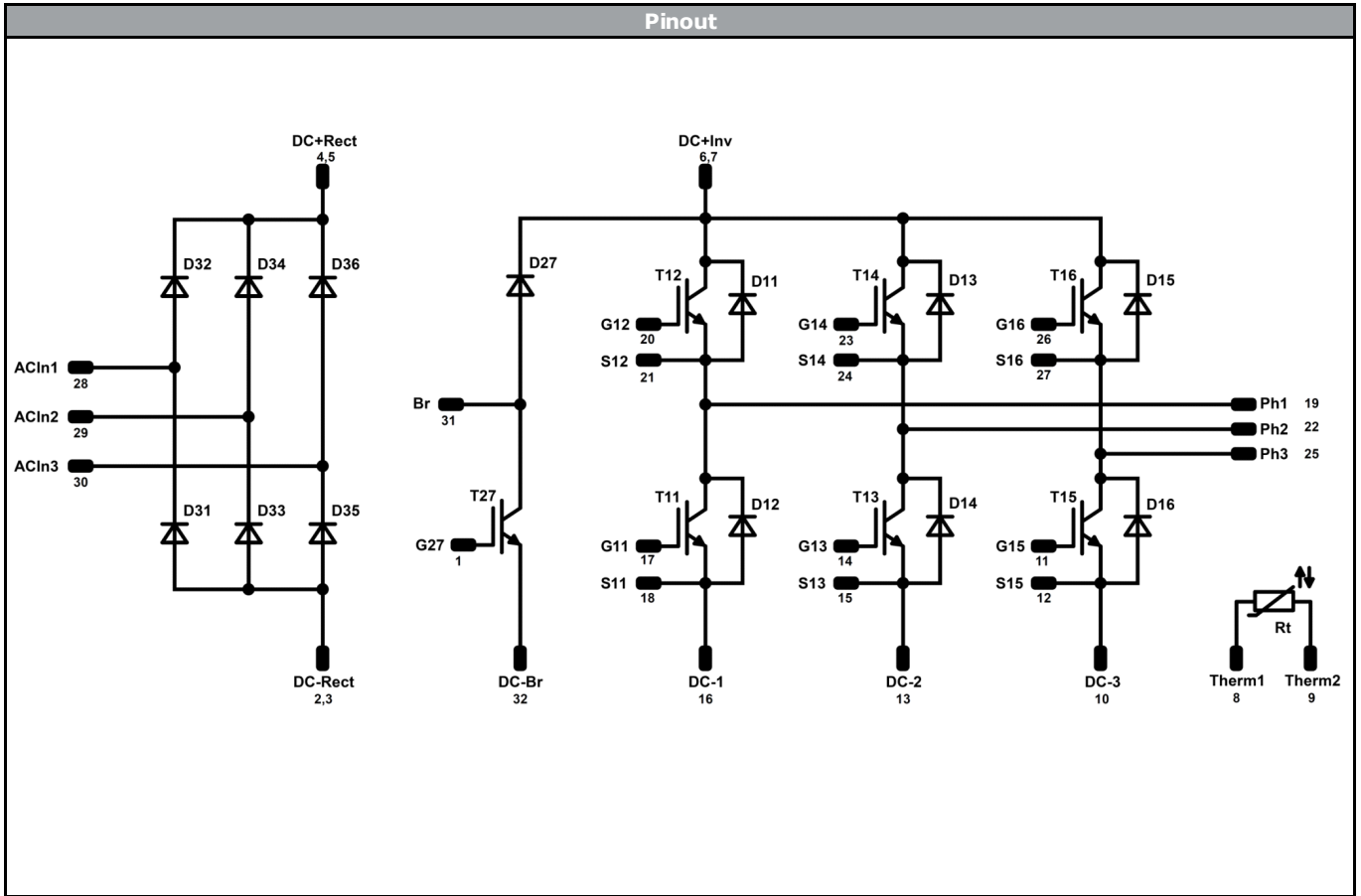

Identification					
ID	Component	Voltage	Current	Function	Comment
D31, D32, D33, D34, D35, D36	Rectifier	1600 V	35 A	Rectifier Diode	
T11, T12, T13, T14, T15, T16	IGBT	1200 V	15 A	Inverter Switch	
D11, D12, D13, D14, D15, D16	FWD	1200 V	15 A	Inverter Diode	
T27	IGBT	1200 V	10 A	Brake Switch	
D27	FWD	1200 V	10 A	Brake Diode	
Rt	NTC			Thermistor	



Packaging instruction			
Standard packaging quantity (SPQ) 100	>SPQ	Standard	<SPQ Sample

Handling instruction
Handling instructions for <i>flow 1</i> packages see vincotech.com website.

Package data
Package data for <i>flow 1</i> packages see vincotech.com website.

UL recognition and file number
This device is certified according to UL 1557 standard, UL file number E192116. For more information see vincotech.com website. 

Document No.:	Date:	Modification:	Pages
10-xY12PMA015M7-P587A7xx-D1-14	15 Nov. 2017		

DISCLAIMER

The information, specifications, procedures, methods and recommendations herein (together "information") are presented by Vincotech to reader in good faith, are believed to be accurate and reliable, but may well be incomplete and/or not applicable to all conditions or situations that may exist or occur. Vincotech reserves the right to make any changes without further notice to any products to improve reliability, function or design. No representation, guarantee or warranty is made to reader as to the accuracy, reliability or completeness of said information or that the application or use of any of the same will avoid hazards, accidents, losses, damages or injury of any kind to persons or property or that the same will not infringe third parties rights or give desired results. It is reader's sole responsibility to test and determine the suitability of the information and the product for reader's intended use.

LIFE SUPPORT POLICY

Vincotech products are not authorised for use as critical components in life support devices or systems without the express written approval of Vincotech.

As used herein:

1. Life support devices or systems are devices or systems which, (a) are intended for surgical implant into the body, or (b) support or sustain life, or (c) whose failure to perform when properly used in accordance with instructions for use provided in labelling can be reasonably expected to result in significant injury to the user.
2. A critical component is any component of a life support device or system whose failure to perform can be reasonably expected to cause the failure of the life support device or system, or to affect its safety or effectiveness.