



<i>flow90PACK 0</i>	1200V/25A				
<table border="1" style="width: 100%; border-collapse: collapse;"> <tr style="background-color: #000080; color: white;"> <th style="text-align: center; padding: 2px;">Features</th> </tr> <tr> <td style="padding: 2px;"> <ul style="list-style-type: none"> <li>90° PCB mounting for easy heat sink assembly</li> <li>Clip-in PCB mounting (optional)</li> <li>Open emitter for easy current sensing</li> </ul> </td> </tr> </table>	Features	<ul style="list-style-type: none"> <li>90° PCB mounting for easy heat sink assembly</li> <li>Clip-in PCB mounting (optional)</li> <li>Open emitter for easy current sensing</li> </ul>	<table border="1" style="width: 100%; border-collapse: collapse;"> <tr style="background-color: #000080; color: white;"> <th style="text-align: center; padding: 2px;"><i>flow90PACK 0</i></th> </tr> <tr> <td style="text-align: center; padding: 2px;">  </td> </tr> </table>	<i>flow90PACK 0</i>	
Features					
<ul style="list-style-type: none"> <li>90° PCB mounting for easy heat sink assembly</li> <li>Clip-in PCB mounting (optional)</li> <li>Open emitter for easy current sensing</li> </ul>					
<i>flow90PACK 0</i>					
					
<table border="1" style="width: 100%; border-collapse: collapse;"> <tr style="background-color: #000080; color: white;"> <th style="text-align: center; padding: 2px;">Target Applications</th> </tr> <tr> <td style="padding: 2px;"> <ul style="list-style-type: none"> <li>Standard Drive</li> <li>Servo Drive</li> <li>Bookshelf Inverter</li> </ul> </td> </tr> </table>	Target Applications	<ul style="list-style-type: none"> <li>Standard Drive</li> <li>Servo Drive</li> <li>Bookshelf Inverter</li> </ul>	<table border="1" style="width: 100%; border-collapse: collapse;"> <tr style="background-color: #000080; color: white;"> <th style="text-align: center; padding: 2px;">Schematic</th> </tr> <tr> <td style="text-align: center; padding: 2px;">  </td> </tr> </table>	Schematic	
Target Applications					
<ul style="list-style-type: none"> <li>Standard Drive</li> <li>Servo Drive</li> <li>Bookshelf Inverter</li> </ul>					
Schematic					
					
<table border="1" style="width: 100%; border-collapse: collapse;"> <tr style="background-color: #000080; color: white;"> <th style="text-align: center; padding: 2px;">Types</th> </tr> <tr> <td style="padding: 2px;"> <ul style="list-style-type: none"> <li>10-RZ126PA025SC-M629F41</li> <li>10-R0126PA025SC-M629F40</li> </ul> </td> </tr> </table>	Types	<ul style="list-style-type: none"> <li>10-RZ126PA025SC-M629F41</li> <li>10-R0126PA025SC-M629F40</li> </ul>			
Types					
<ul style="list-style-type: none"> <li>10-RZ126PA025SC-M629F41</li> <li>10-R0126PA025SC-M629F40</li> </ul>					

### Maximum Ratings

$T_J=25^{\circ}\text{C}$ , unless otherwise specified

Parameter	Symbol	Condition	Value	Unit
<b>Inverter Transistor</b>				
Collector-emitter break down voltage	$V_{CE}$		1200	V
DC collector current *	$I_C$	$T_J=T_{Jmax}$ $T_h=80^{\circ}\text{C}$ $T_c=80^{\circ}\text{C}$	29 38	A
Pulsed collector current	$I_{Cpulse}$	$t_p$ limited by $T_{Jmax}$	75	A
Turn off safe operating area		$V_{CE} \leq 1200\text{V}$ , $T_J \leq T_{op max}$	50	A
Power dissipation per IGBT *	$P_{tot}$	$T_J=T_{Jmax}$ $T_h=80^{\circ}\text{C}$ $T_c=80^{\circ}\text{C}$	81 123	W
Gate-emitter peak voltage	$V_{GE}$		$\pm 20$	V
Short circuit ratings	$t_{SC}$ $V_{CC}$	$T_J \leq 150^{\circ}\text{C}$ $V_{GE}=15\text{V}$	10 800	$\mu\text{s}$ V
Maximum Junction Temperature	$T_{Jmax}$		175	$^{\circ}\text{C}$

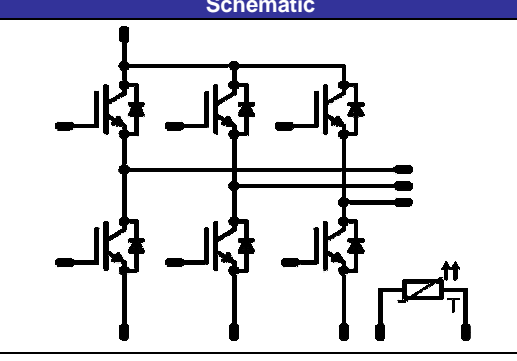
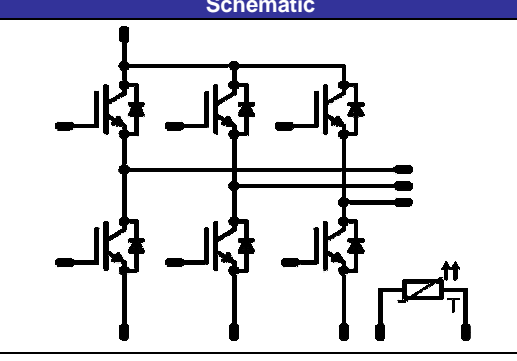
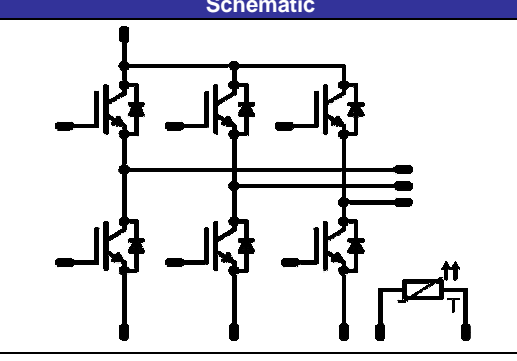
\* measured with phase-change material

<b>Inverter Diode</b>				
Peak Repetitive Reverse Voltage	$V_{RRM}$		1200	V
DC forward current *	$I_F$	$T_J=T_{Jmax}$ $T_h=80^{\circ}\text{C}$ $T_c=80^{\circ}\text{C}$	32 42	A
Repetitive peak forward current	$I_{FRM}$	$t_p$ limited by $T_{Jmax}$	50	A
Power dissipation per Diode *	$P_{tot}$	$T_J=T_{Jmax}$ $T_h=80^{\circ}\text{C}$ $T_c=80^{\circ}\text{C}$	63 96	W
Maximum Junction Temperature	$T_{Jmax}$		175	$^{\circ}\text{C}$

\* measured with phase-change material

### Maximum Ratings

$T_j=25^{\circ}\text{C}$ , unless otherwise specified

Parameter	Symbol	Condition	Value	Unit
-----------	--------	-----------	-------	------

#### Thermal Properties

Storage temperature	$T_{\text{stg}}$		-40...+125	$^{\circ}\text{C}$
Operation temperature under switching condition	$T_{\text{op}}$		-40...+( $T_{\text{jmax}}$ - 25)	$^{\circ}\text{C}$

#### Insulation Properties

Insulation voltage	$V_{\text{is}}$	t=2s DC voltage	4000	V
Creepage distance			min 12,7	mm
Clearance			min 10,93	mm
Comparative tracking index	CTI		>200	

**Characteristic Values**

Parameter	Symbol	Conditions					Value			Unit
		$V_{GE}[V]$ or $V_{GS}[V]$	$V_r[V]$ or $V_{CE}[V]$ or $V_{DS}[V]$	$I_c[A]$ or $I_F[A]$ or $I_b[A]$	$T_j$	Min	Typ	Max		
<b>Inverter Transistor</b>										
Gate emitter threshold voltage	$V_{GE(th)}$	$V_{CE}=V_{GE}$			0,00085	$T_j=25^\circ C$ $T_j=150^\circ C$	5	5,8	6,5	V
Collector-emitter saturation voltage	$V_{CE(sat)}$		15		25	$T_j=25^\circ C$ $T_j=150^\circ C$	1,5	1,96 2,28	2,4	V
Collector-emitter cut-off current incl. Diode	$I_{CES}$		0	1200		$T_j=25^\circ C$ $T_j=150^\circ C$			0,01	mA
Gate-emitter leakage current	$I_{GES}$		20	0		$T_j=25^\circ C$ $T_j=150^\circ C$			200	nA
Integrated Gate resistor	$R_{gint}$							none		$\Omega$
Turn-on delay time	$t_{d(on)}$	Rgoff=16 $\Omega$ Rgon=16 $\Omega$	$\pm 15$	600	25	$T_j=25^\circ C$		66		ns
Rise time	$t_r$					$T_j=150^\circ C$		67		
Turn-off delay time	$t_{d(off)}$					$T_j=25^\circ C$		42		
Fall time	$t_f$					$T_j=150^\circ C$		43		
Turn-on energy loss per pulse	$E_{on}$					$T_j=25^\circ C$		196		
Turn-off energy loss per pulse	$E_{off}$					$T_j=150^\circ C$		264		
Input capacitance	$C_{ies}$									
Output capacitance	$C_{oss}$	f=1MHz	0	25		$T_j=25^\circ C$		115		
Reverse transfer capacitance	$C_{rss}$							85		
Gate charge	$Q_{Gate}$		15	960	40	$T_j=25^\circ C$		120		nC
Thermal resistance chip to heatsink per chip	$R_{thJH}$	Phase-Change Material						1,17		K/W
Thermal resistance chip to heatsink per chip	$R_{thJH}$	Thermal grease thickness $\leq 50\mu m$ $\lambda = 1 W/mK$						1,38		K/W
<b>Inverter Diode</b>										
Diode forward voltage	$V_F$				25	$T_j=25^\circ C$ $T_j=150^\circ C$	1,2	1,90 1,83	2,4	V
Peak reverse recovery current	$I_{RRM}$	Rgon=16 $\Omega$	$\pm 15$	600	25	$T_j=25^\circ C$		13		A
Reverse recovery time	$t_{rr}$					$T_j=150^\circ C$		17		
Reverse recovered charge	$Q_{rr}$					$T_j=25^\circ C$		318		
Peak rate of fall of recovery current	$di(rec)max/dt$					$T_j=150^\circ C$		524		
Reverse recovered energy	$E_{rec}$					$T_j=25^\circ C$		2,22		
						$T_j=150^\circ C$		4,50		
Thermal resistance chip to heatsink per chip	$R_{thJH}$	Phase-Change Material						1,51		K/W
Thermal resistance chip to heatsink per chip	$R_{thJH}$	Thermal grease thickness $\leq 50\mu m$ $\lambda = 1 W/mK$						1,77		K/W
<b>Thermistor</b>										
Rated resistance	R					$T_j=25^\circ C$		4700		$\Omega$
Deviation of R25	$\Delta R/R$					$T_j=25^\circ C$	-5		5	%
Power dissipation	P					$T_j=25^\circ C$		200		mW
Power dissipation constant						$T_j=25^\circ C$		2		mW/K
B-value	$B_{(25/50)}$	Tol. $\pm 3\%$				$T_j=25^\circ C$		3500		K
B-value	$B_{(25/100)}$					$T_j=25^\circ C$		3560		K
Vincotech NTC Reference						$T_j=25^\circ C$			G	

## Output Inverter

**Figure 1** Output inverter IGBT

**Typical output characteristics**

$I_C = f(V_{CE})$

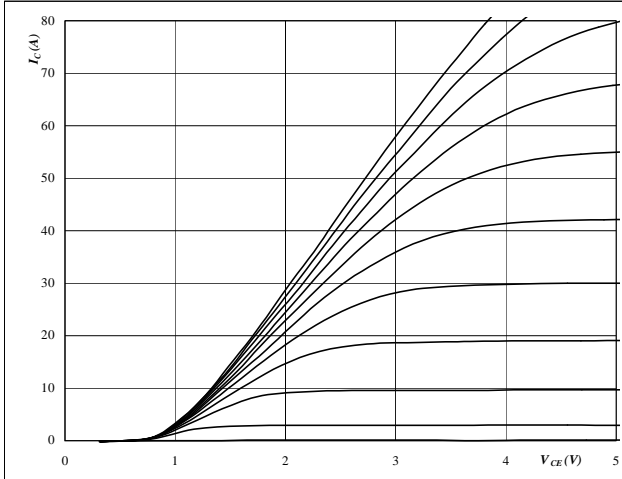

**At**  
 $t_p = 250 \mu s$   
 $T_j = 25 \text{ }^\circ C$   
 $V_{GE}$  from 7 V to 17 V in steps of 1 V

**Figure 2** Output inverter IGBT

**Typical output characteristics**

$I_C = f(V_{CE})$

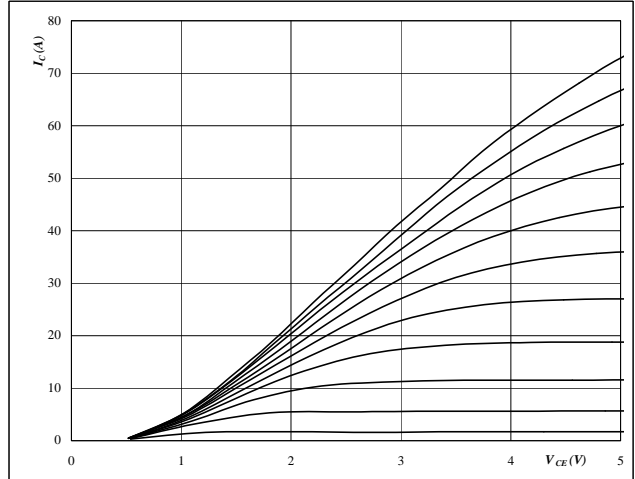

**At**  
 $t_p = 250 \mu s$   
 $T_j = 150 \text{ }^\circ C$   
 $V_{GE}$  from 7 V to 17 V in steps of 1 V

**Figure 3** Output inverter IGBT

**Typical transfer characteristics**

$I_C = f(V_{GE})$

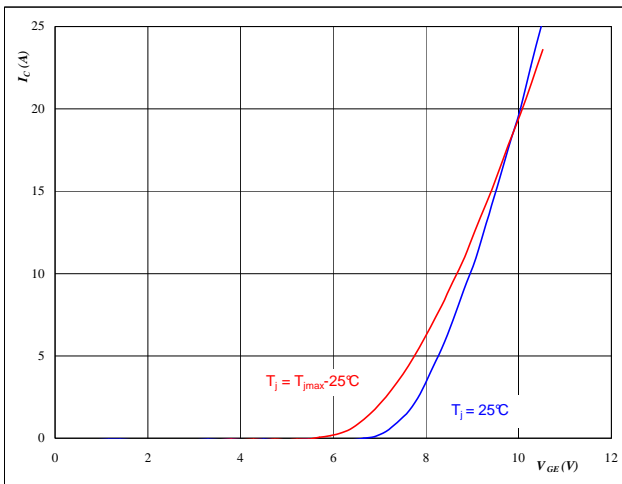

**At**  
 $t_p = 250 \mu s$   
 $V_{CE} = 10 \text{ V}$

**Figure 4** Output inverter FWD

**Typical diode forward current as a function of forward voltage**

$I_F = f(V_F)$

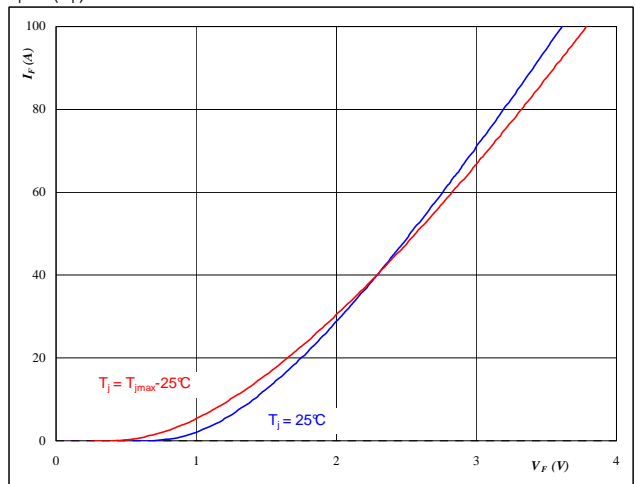

**At**  
 $t_p = 250 \mu s$

## Output Inverter

**Figure 5** Output inverter IGBT

**Typical switching energy losses**  
**as a function of collector current**

$$E = f(I_C)$$

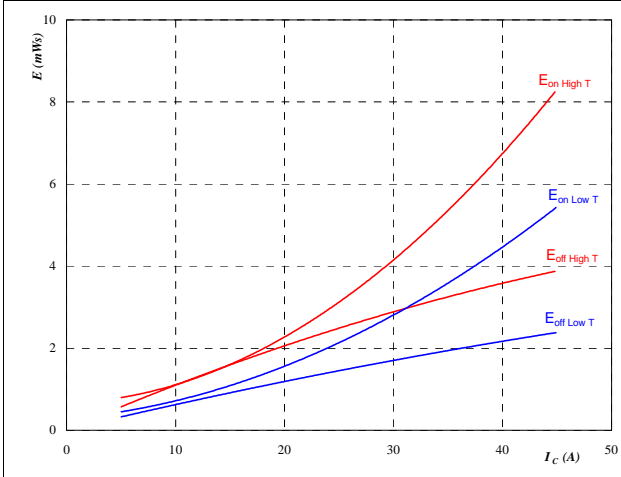

With an inductive load at

$T_J =$	25/150	°C
$V_{CE} =$	600	V
$V_{GE} =$	±15	V
$R_{gon} =$	16	Ω
$R_{goff} =$	16	Ω

**Figure 6** Output inverter IGBT

**Typical switching energy losses**  
**as a function of gate resistor**

$$E = f(R_G)$$

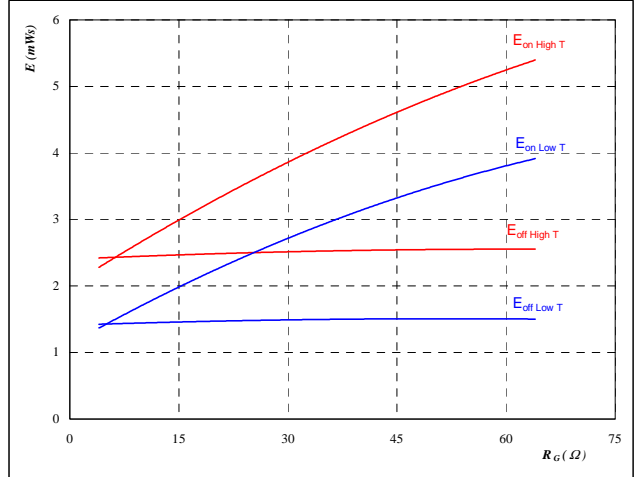

With an inductive load at

$T_J =$	25/150	°C
$V_{CE} =$	600	V
$V_{GE} =$	±15	V
$I_C =$	25	A

**Figure 7** Output inverter FWD

**Typical reverse recovery energy loss**  
**as a function of collector current**

$$E_{rec} = f(I_C)$$

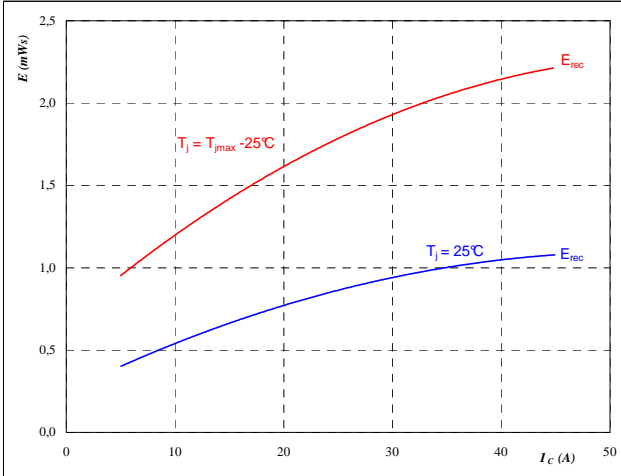

With an inductive load at

$T_J =$	25/150	°C
$V_{CE} =$	600	V
$V_{GE} =$	±15	V
$R_{gon} =$	16	Ω

**Figure 8** Output inverter FWD

**Typical reverse recovery energy loss**  
**as a function of gate resistor**

$$E_{rec} = f(R_G)$$

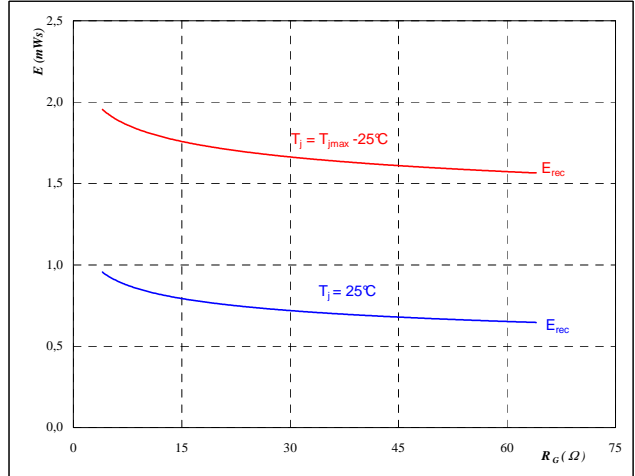

With an inductive load at

$T_J =$	25/150	°C
$V_{CE} =$	600	V
$V_{GE} =$	±15	V
$I_C =$	25	A

## Output Inverter

**Figure 9** Output inverter IGBT

Typical switching times as a function of collector current

$$t = f(I_C)$$

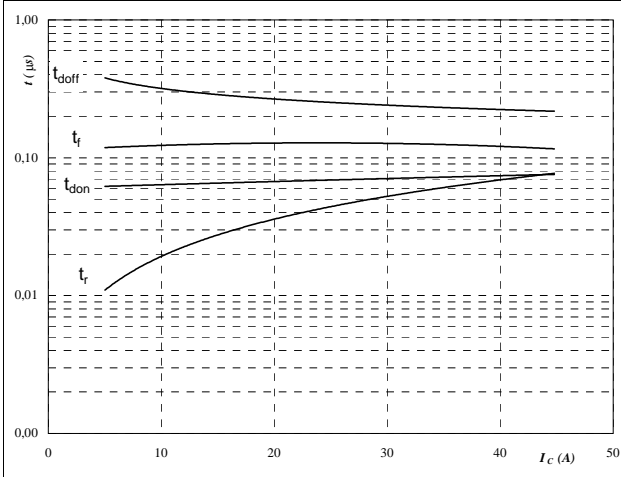

With an inductive load at

$T_j =$	150	°C
$V_{CE} =$	600	V
$V_{GE} =$	$\pm 15$	V
$R_{\text{gon}} =$	16	$\Omega$
$R_{\text{goff}} =$	16	$\Omega$

**Figure 10** Output inverter IGBT

Typical switching times as a function of gate resistor

$$t = f(R_G)$$

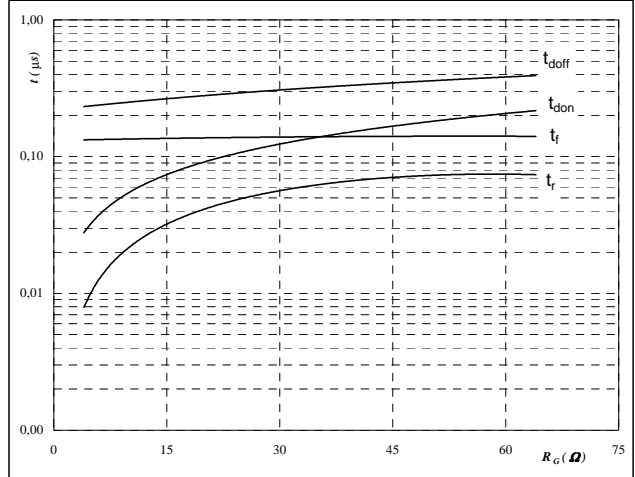

With an inductive load at

$T_j =$	150	°C
$V_{CE} =$	600	V
$V_{GE} =$	$\pm 15$	V
$I_C =$	25	A

**Figure 11** Output inverter FWD

Typical reverse recovery time as a function of collector current

$$t_{rr} = f(I_C)$$

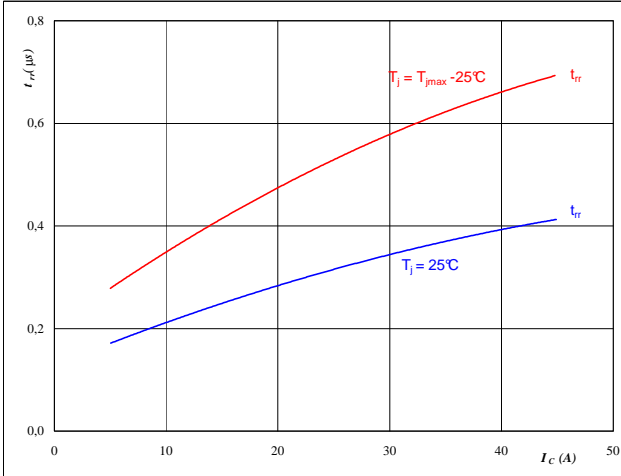

At

$T_j =$	25/150	°C
$V_{CE} =$	600	V
$V_{GE} =$	$\pm 15$	V
$R_{\text{gon}} =$	16	$\Omega$

**Figure 12** Output inverter FWD

Typical reverse recovery time as a function of IGBT turn on gate resistor

$$t_{rr} = f(R_{\text{gon}})$$

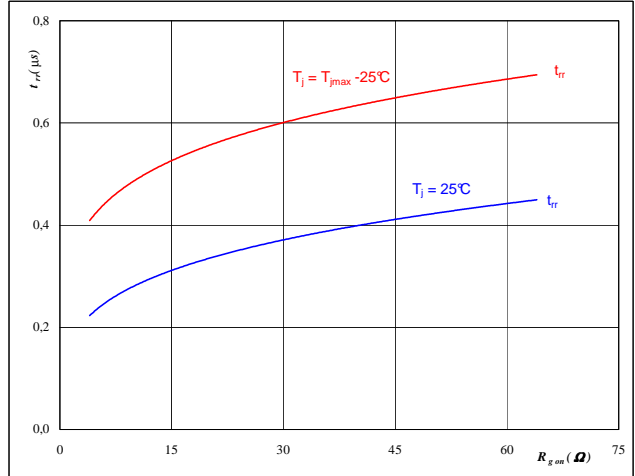

At

$T_j =$	25/150	°C
$V_R =$	600	V
$I_F =$	25	A
$V_{GE} =$	$\pm 15$	V

## Output Inverter

**Figure 13** Output inverter FWD

Typical reverse recovery charge as a function of collector current

$$Q_{rr} = f(I_C)$$

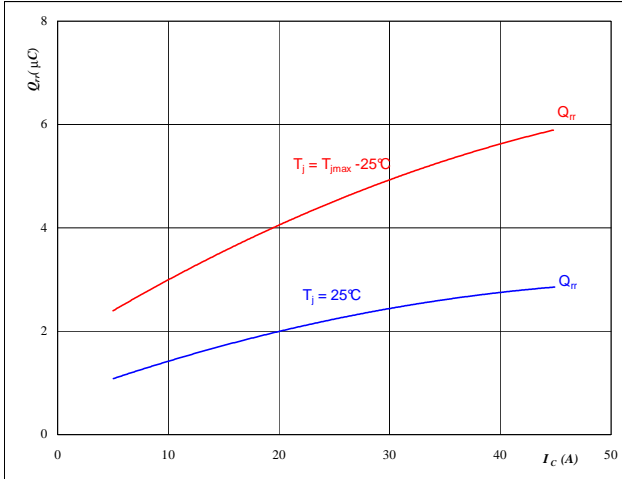

At

$T_j =$	25/150	°C
$V_{CE} =$	600	V
$V_{GE} =$	±15	V
$R_{gon} =$	16	Ω

**Figure 14** Output inverter FWD

Typical reverse recovery charge as a function of IGBT turn on gate resistor

$$Q_{rr} = f(R_{gon})$$

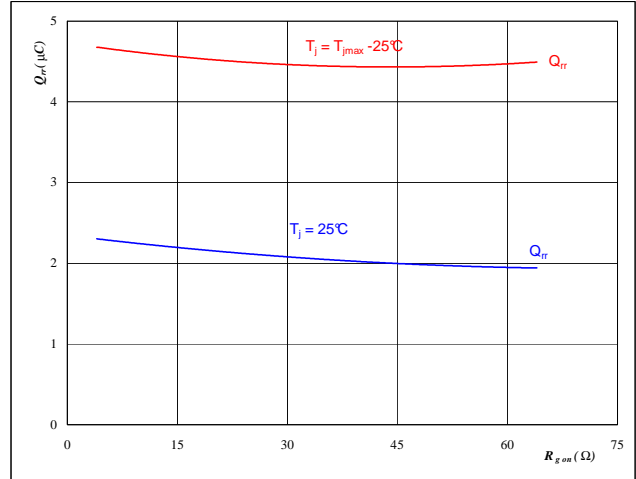

At

$T_j =$	25/150	°C
$V_R =$	600	V
$I_F =$	25	A
$V_{GE} =$	±15	V

**Figure 15** Output inverter FWD

Typical reverse recovery current as a function of collector current

$$I_{RRM} = f(I_C)$$

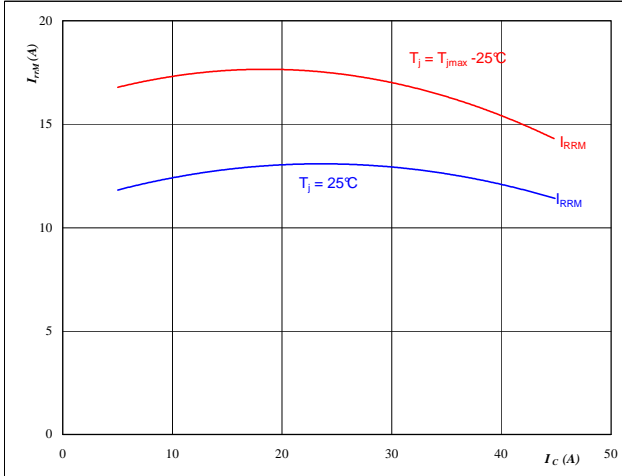

At

$T_j =$	25/150	°C
$V_{CE} =$	600	V
$V_{GE} =$	±15	V
$R_{gon} =$	16	Ω

**Figure 16** Output inverter FWD

Typical reverse recovery current as a function of IGBT turn on gate resistor

$$I_{RRM} = f(R_{gon})$$

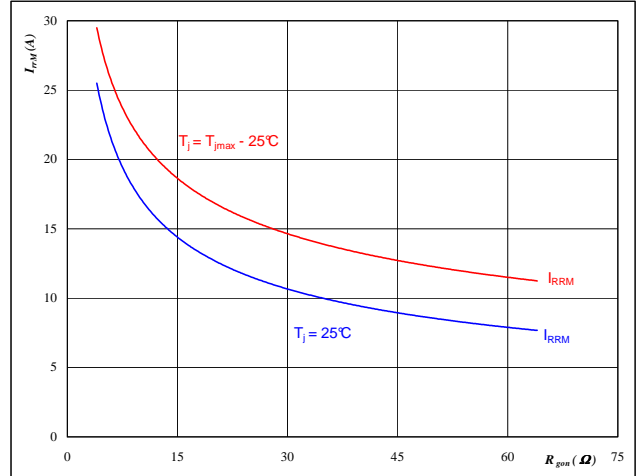

At

$T_j =$	25/150	°C
$V_R =$	600	V
$I_F =$	25	A
$V_{GE} =$	±15	V

## Output Inverter

Figure 17 Output inverter FWD

Typical rate of fall of forward and reverse recovery current as a function of collector current

$$dI_f/dt, dI_{rec}/dt = f(I_C)$$

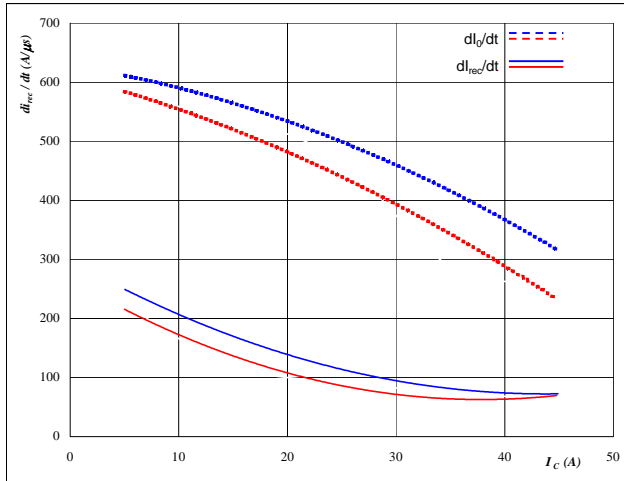

At  
 $T_j = 25/150 \text{ } ^\circ\text{C}$   
 $V_{CE} = 600 \text{ V}$   
 $V_{GE} = \pm 15 \text{ V}$   
 $R_{gon} = 16 \text{ } \Omega$

Figure 18 Output inverter FWD

Typical rate of fall of forward and reverse recovery current as a function of IGBT turn on gate resistor

$$dI_f/dt, dI_{rec}/dt = f(R_{gon})$$

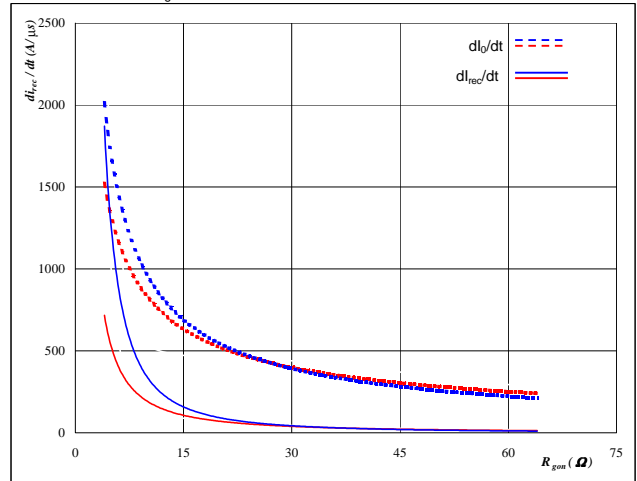

At  
 $T_j = 25/150 \text{ } ^\circ\text{C}$   
 $V_R = 600 \text{ V}$   
 $I_F = 25 \text{ A}$   
 $V_{GE} = \pm 15 \text{ V}$

Figure 19 Output inverter IGBT

IGBT transient thermal impedance as a function of pulse width

$$Z_{thJH} = f(t_p)$$

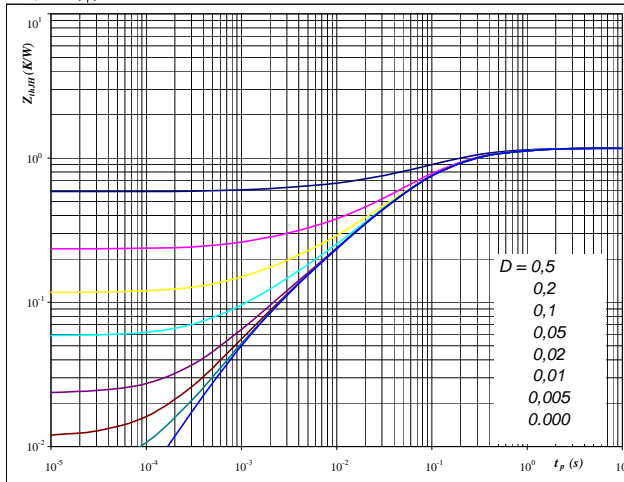

At  
 $D = t_p / T$   
 $R_{thJH} = 1,17 \text{ K/W}$       $R_{thJH} = 1,38 \text{ K/W}$

### IGBT thermal model values

Phase change interface		Thermal grease	
R (C/W)	Tau (s)	R (C/W)	Tau (s)
0,10	1,4E+00	0,12	1,4E+00
0,44	1,8E-01	0,51	1,8E-01
0,44	5,7E-02	0,52	5,7E-02
0,14	9,8E-03	0,17	9,8E-03
0,05	1,3E-03	0,06	1,3E-03

Figure 20 Output inverter FWD

FWD transient thermal impedance as a function of pulse width

$$Z_{thJH} = f(t_p)$$

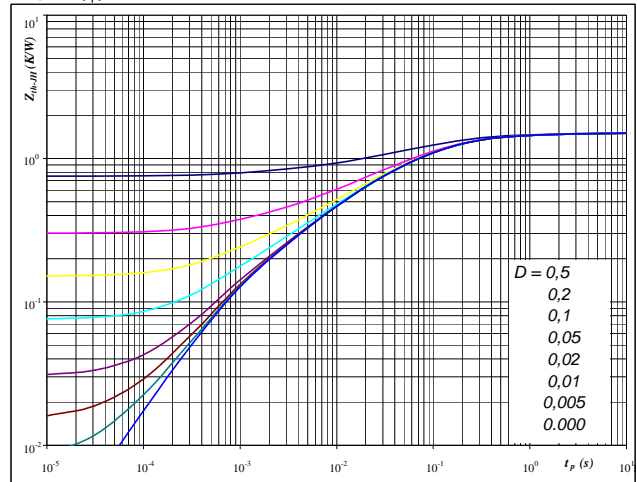

At  
 $D = t_p / T$   
 $R_{thJH} = 1,51 \text{ K/W}$       $R_{thJH} = 1,77 \text{ K/W}$

### FWD thermal model values

Phase change interface		Thermal grease	
R (C/W)	Tau (s)	R (C/W)	Tau (s)
0,06	2,9E+00	0,07	2,9E+00
0,19	4,2E-01	0,22	4,2E-01
0,59	9,2E-02	0,70	9,2E-02
0,35	2,3E-02	0,41	2,3E-02
0,20	6,0E-03	0,24	6,0E-03
0,11	8,7E-04	0,13	8,7E-04



## Output Inverter

**Figure 21** Output inverter IGBT

**Power dissipation as a function of heatsink temperature**

$$P_{tot} = f(T_h)$$

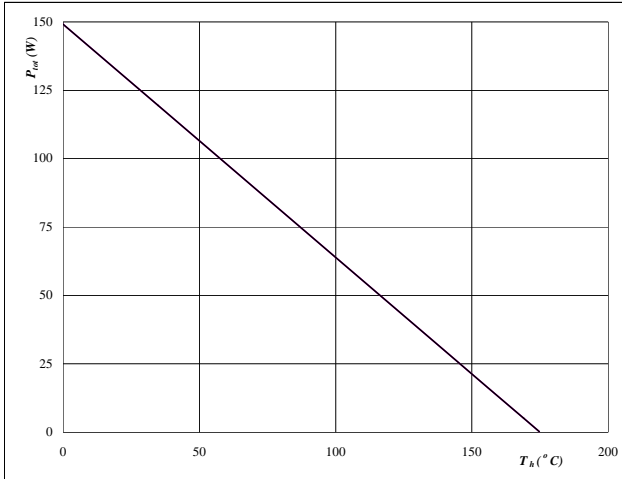
**At**  
 $T_j = 175 \text{ } ^\circ\text{C}$ 
**Figure 22** Output inverter IGBT

**Collector current as a function of heatsink temperature**

$$I_C = f(T_h)$$

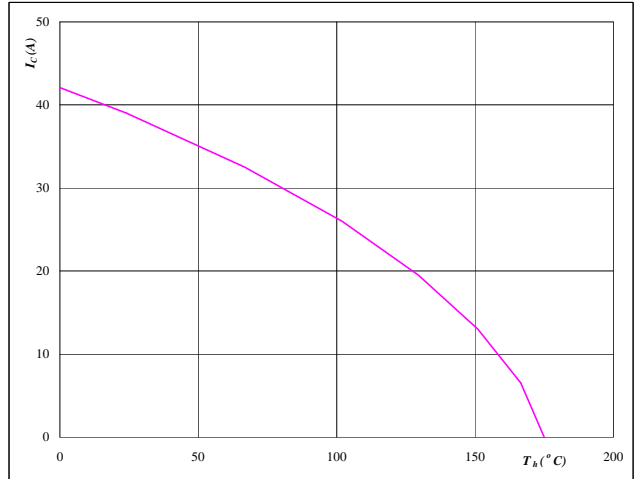
**At**  
 $T_j = 175 \text{ } ^\circ\text{C}$   
 $V_{GE} = 15 \text{ V}$ 
**Figure 23** Output inverter FWD

**Power dissipation as a function of heatsink temperature**

$$P_{tot} = f(T_h)$$

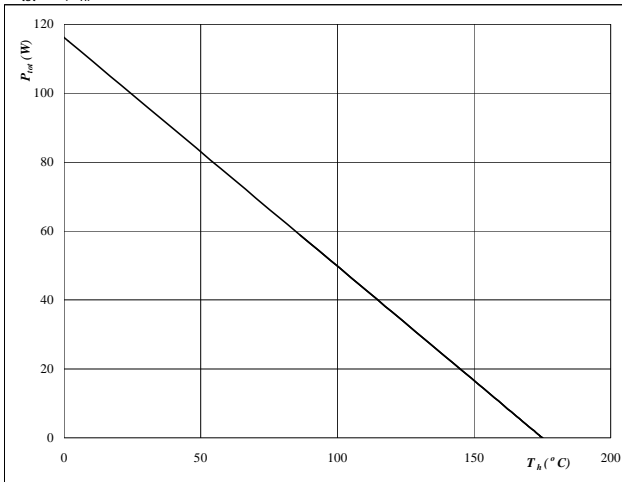
**At**  
 $T_j = 175 \text{ } ^\circ\text{C}$ 
**Figure 24** Output inverter FWD

**Forward current as a function of heatsink temperature**

$$I_F = f(T_h)$$

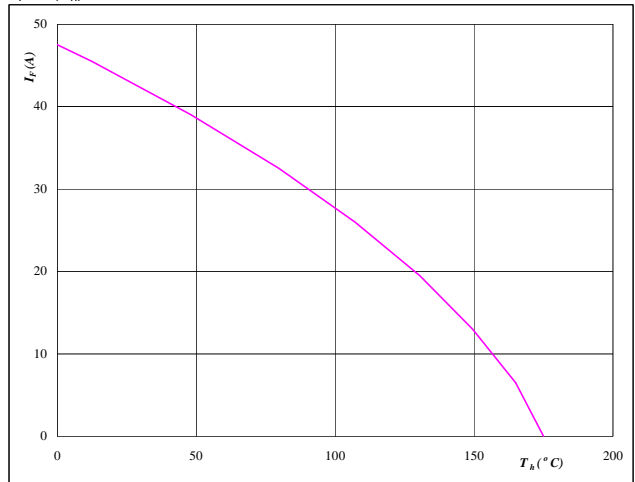
**At**  
 $T_j = 175 \text{ } ^\circ\text{C}$

## Output Inverter

**Figure 25** Output inverter IGBT

Safe operating area as a function of collector-emitter voltage  
 $I_C = f(V_{CE})$

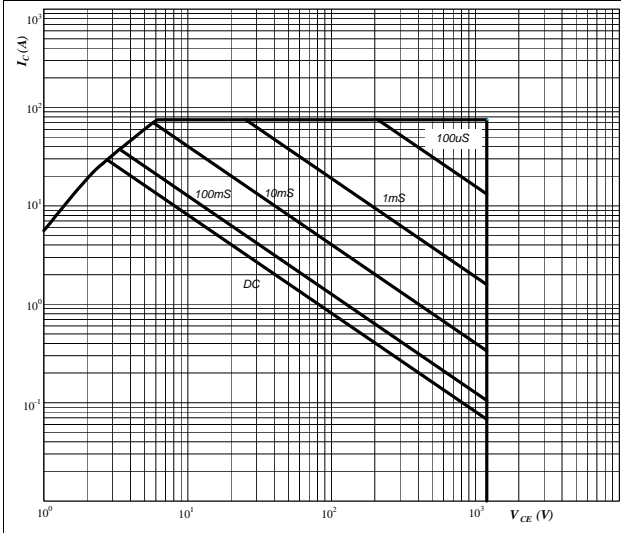

**At**  
 D = single pulse  
 $T_h = 80$  °C  
 $V_{GE} = \pm 15$  V  
 $T_j = T_{jmax}$  °C

**Figure 26** Output inverter IGBT

Gate voltage vs Gate charge

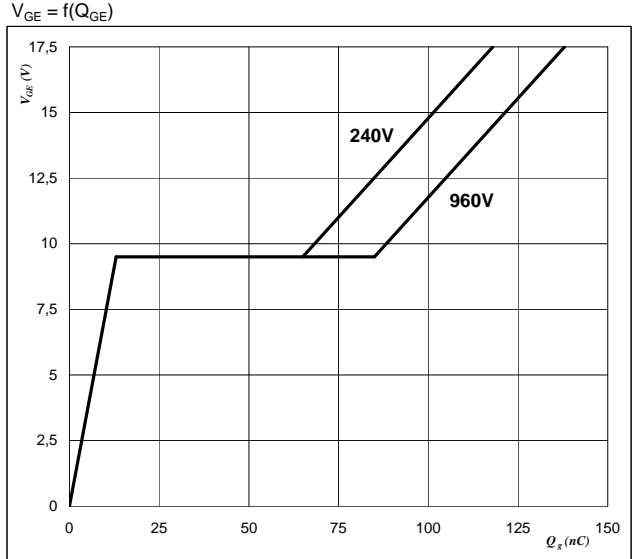

**At**  
 $I_C = 25$  A

**Figure 27** Output inverter IGBT

Short circuit withstand time as a function of gate-emitter voltage  
 $t_{sc} = f(V_{GE})$

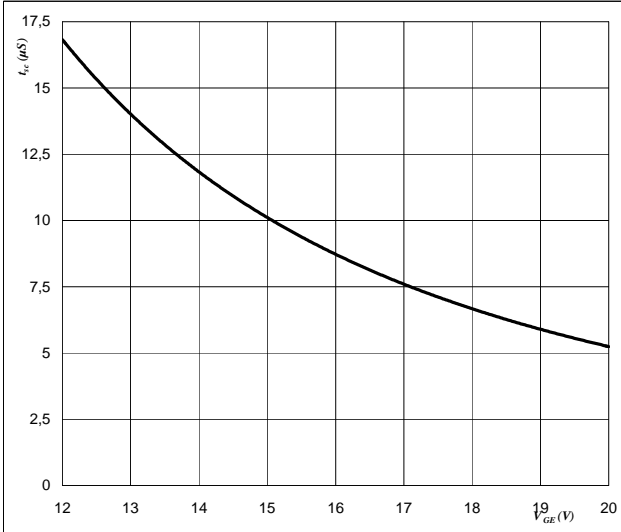

**At**  
 $V_{CE} = 600$  V  
 $T_j \leq 175$  °C

**Figure 28** Output inverter IGBT

Typical short circuit collector current as a function of gate-emitter voltage  
 $V_{GE} = f(Q_{GE})$

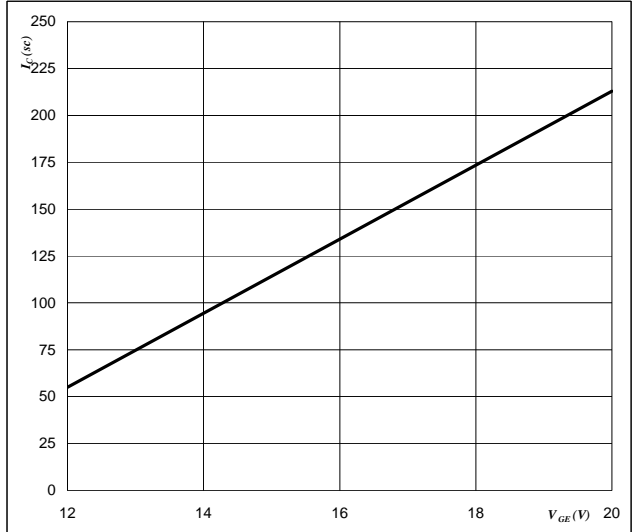

**At**  
 $V_{CE} \leq 600$  V  
 $T_j = 175$  °C

**Figure 29** IGBT

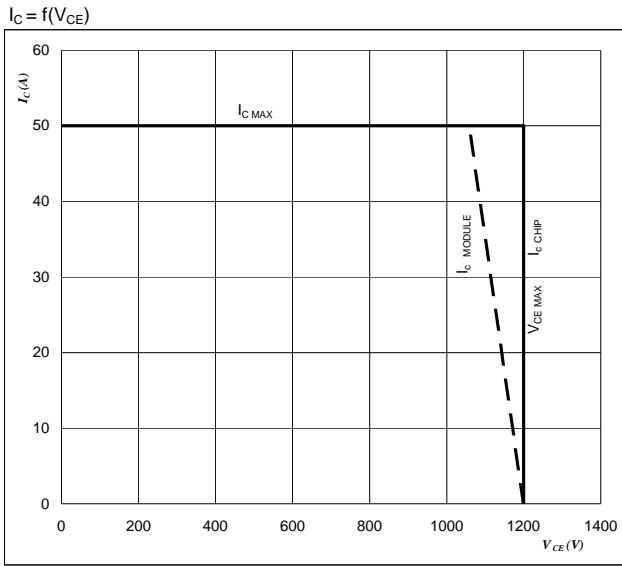
**Reverse bias safe operating area**

**At**

$$T_j = T_{jmax} - 25 \text{ } ^\circ\text{C}$$

$$U_{ocminus} = U_{ccplus}$$

Switching mode : 3 level switching

**Thermistor**

**Figure 1** Thermistor

**Typical NTC characteristic  
as a function of temperature**

$R_T = f(T)$

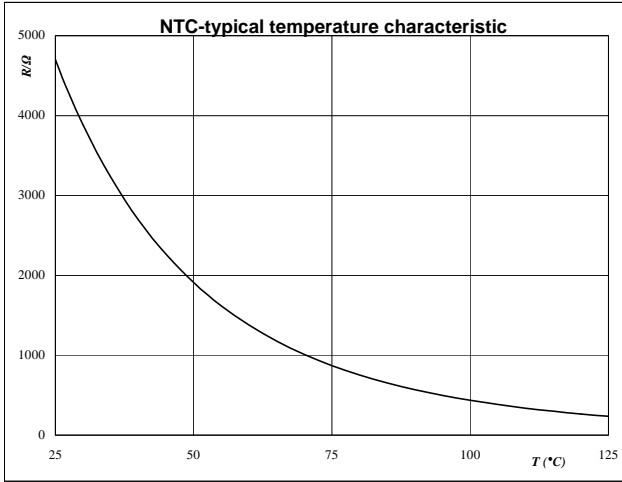

## Switching Definitions Output Inverter

General conditions	
$T_j$	= 150 °C
$R_{gon}$	= 16 Ω
$R_{goff}$	= 16 Ω

Figure 1 Output inverter IGBT

Turn-off Switching Waveforms & definition of  $t_{doff}$ ,  $t_{Eoff}$   
( $t_{Eoff}$  = integrating time for  $E_{off}$ )

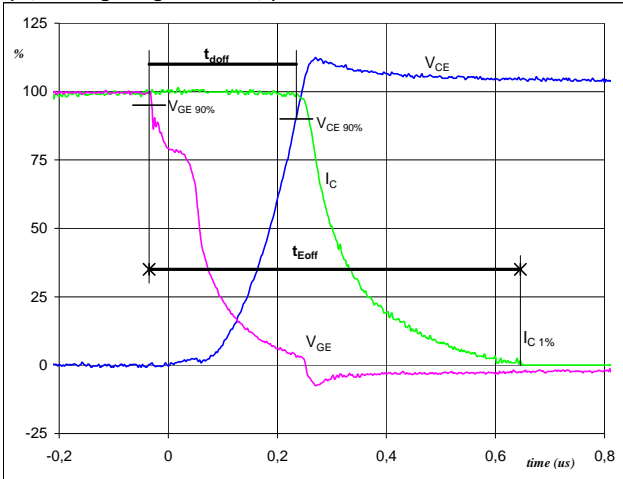

$V_{GE}(0\%) =$	-15	V
$V_{GE}(100\%) =$	15	V
$V_C(100\%) =$	600	V
$I_C(100\%) =$	25	A
$t_{doff} =$	0,26	μs
$t_{Eoff} =$	0,68	μs

Figure 2 Output inverter IGBT

Turn-on Switching Waveforms & definition of  $t_{don}$ ,  $t_{Eon}$   
( $t_{Eon}$  = integrating time for  $E_{on}$ )

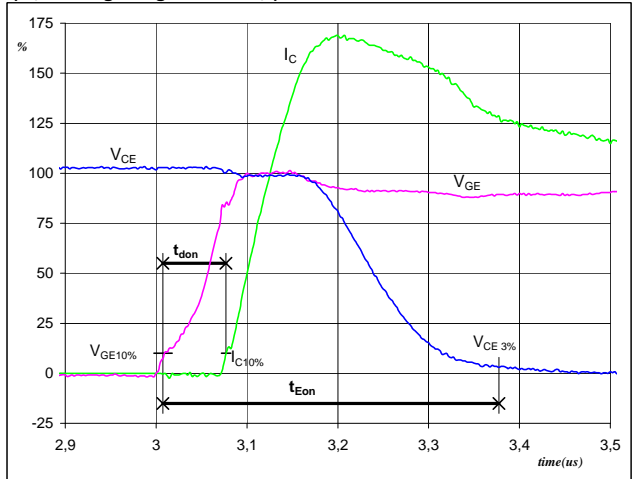

$V_{GE}(0\%) =$	-15	V
$V_{GE}(100\%) =$	15	V
$V_C(100\%) =$	600	V
$I_C(100\%) =$	25	A
$t_{don} =$	0,07	μs
$t_{Eon} =$	0,37	μs

Figure 3 Output inverter IGBT

Turn-off Switching Waveforms & definition of  $t_f$

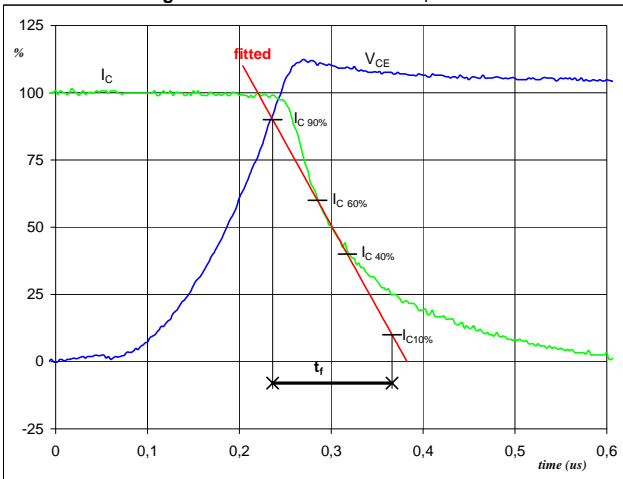

$V_C(100\%) =$	600	V
$I_C(100\%) =$	25	A
$t_f =$	0,14	μs

Figure 4 Output inverter IGBT

Turn-on Switching Waveforms & definition of  $t_r$

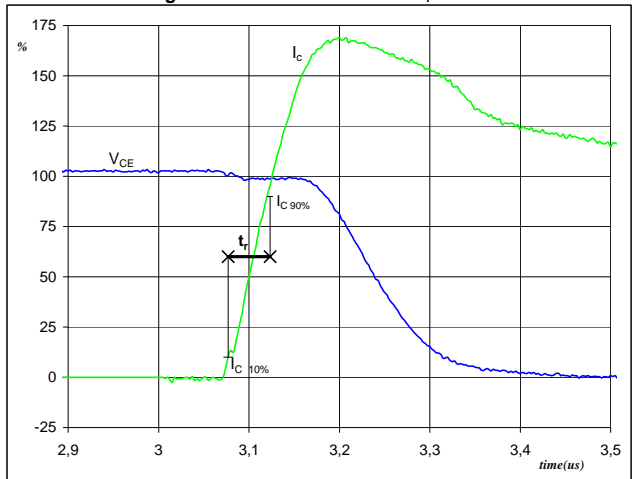

$V_C(100\%) =$	600	V
$I_C(100\%) =$	25	A
$t_r =$	0,04	μs

## Switching Definitions Output Inverter

**Figure 5** Output inverter IGBT

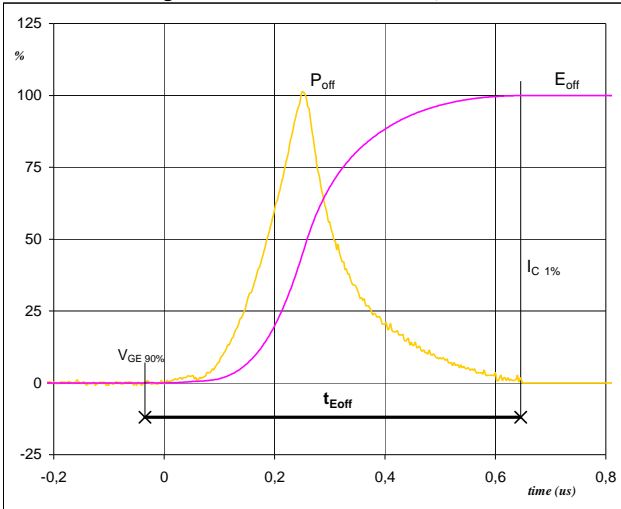
**Turn-off Switching Waveforms & definition of  $t_{Eoff}$** 

$P_{off} (100\%) =$	15,00	kW
$E_{off} (100\%) =$	2,48	mJ
$t_{Eoff} =$	0,68	$\mu$ s

**Figure 6** Output inverter IGBT

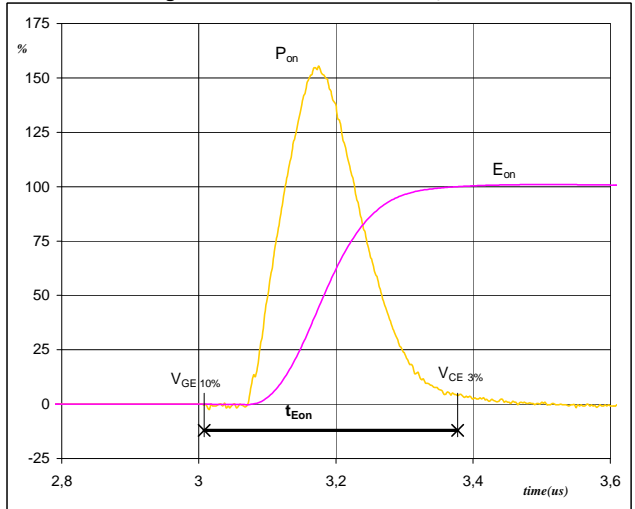
**Turn-on Switching Waveforms & definition of  $t_{Eon}$** 

$P_{on} (100\%) =$	15,00	kW
$E_{on} (100\%) =$	3,15	mJ
$t_{Eon} =$	0,37	$\mu$ s

**Figure 7** Output inverter IGBT

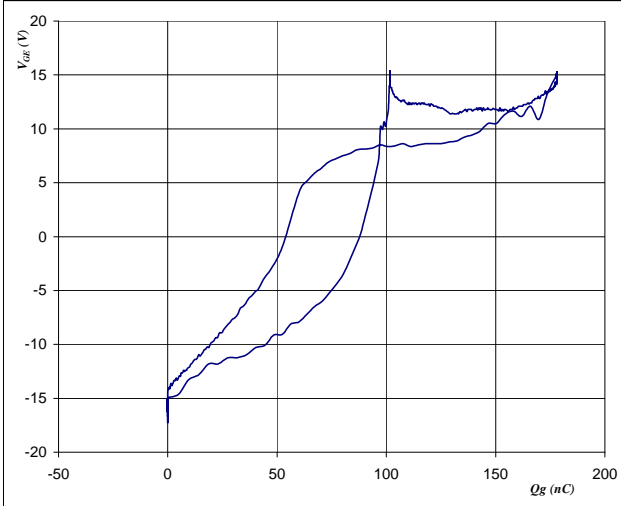
**Gate voltage vs Gate charge (measured)**

$V_{GEoff} =$	-15	V
$V_{GEon} =$	15	V
$V_C (100\%) =$	600	V
$I_C (100\%) =$	25	A
$Q_g =$	177,97	nC

**Figure 8** Output inverter FWD

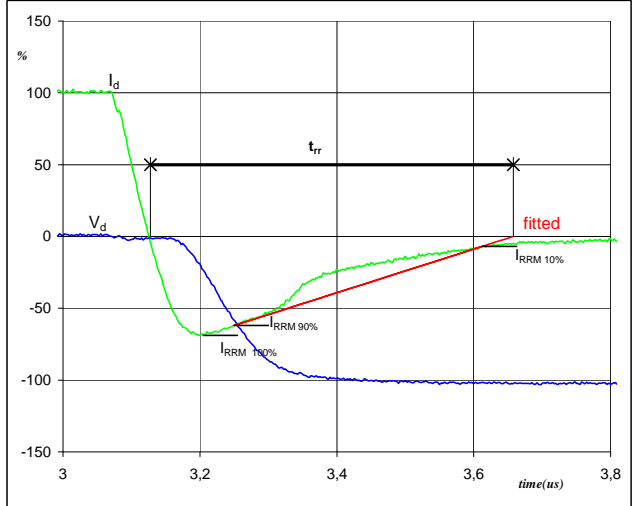
**Turn-off Switching Waveforms & definition of  $t_{rr}$** 

$V_d (100\%) =$	600	V
$I_d (100\%) =$	25	A
$I_{RRM} (100\%) =$	-17	A
$t_{rr} =$	0,52	$\mu$ s

## Switching Definitions Output Inverter

**Figure 9** Output inverter FWD

Turn-on Switching Waveforms & definition of  $t_{Qrr}$   
 ( $t_{Qrr}$  = integrating time for  $Q_{rr}$ )

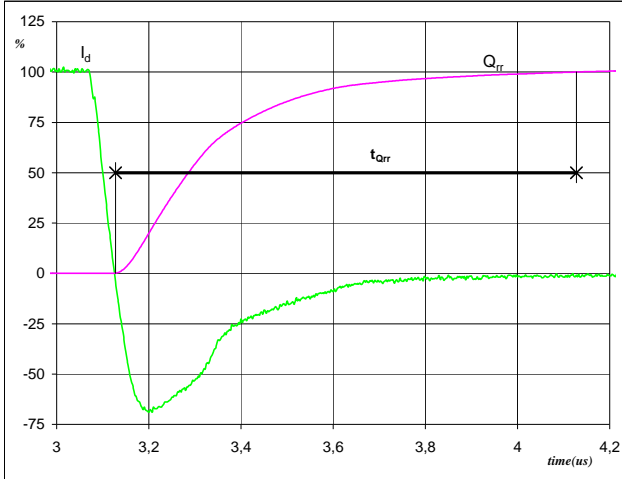

$I_d$  (100%) = 25 A  
 $Q_{rr}$  (100%) = 4,50  $\mu$ C  
 $t_{Qrr}$  = 1,00  $\mu$ s

**Figure 10** Output inverter FWD

Turn-on Switching Waveforms & definition of  $t_{Erec}$   
 ( $t_{Erec}$  = integrating time for  $E_{rec}$ )

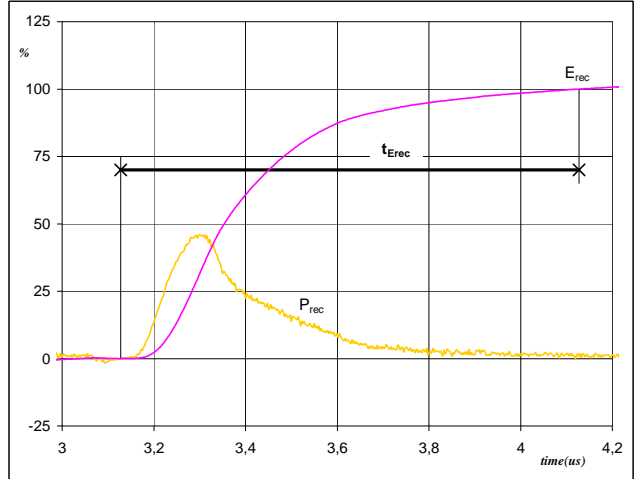

$P_{rec}$  (100%) = 15,00 kW  
 $E_{rec}$  (100%) = 1,78 mJ  
 $t_{Erec}$  = 1,00  $\mu$ s

**Ordering Code and Marking - Outline - Pinout**
**Ordering Code & Marking**

Version	Ordering Code	in DataMatrix as	in packaging barcode as
without thermal paste ,housing without clips	10-RZ126PA025SC-M629F41	M629F41	M629F41
without thermal paste ,housing with clips	10-R0126PA025SC-M629F40	M629F40	M629F40

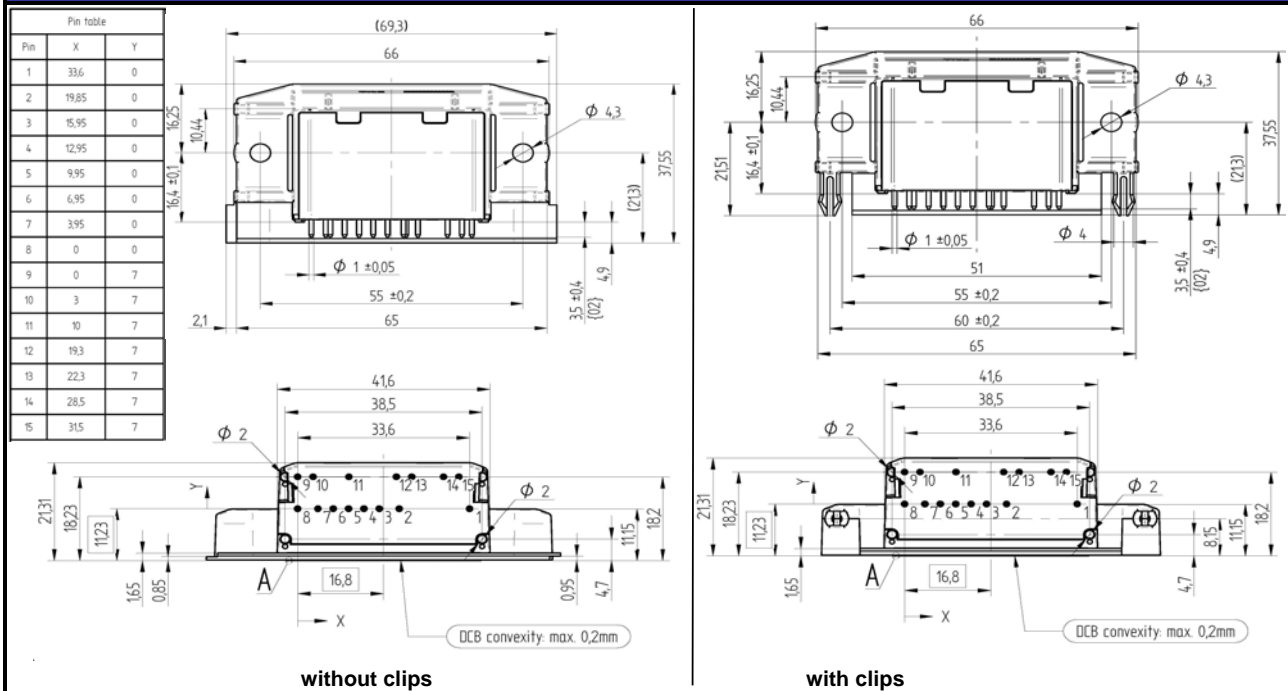
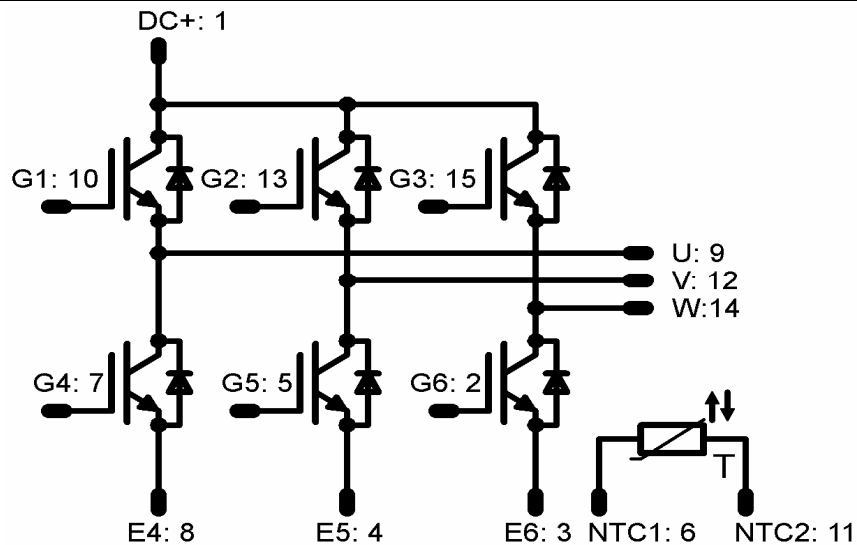
**Outline**

**Pinout**



**DISCLAIMER**

The information given in this datasheet describes the type of component and does not represent assured characteristics. For tested values please contact Vincotech. Vincotech reserves the right to make changes without further notice to any products herein to improve reliability, function or design. Vincotech does not assume any liability arising out of the application or use of any product or circuit described herein; neither does it convey any license under its patent rights, nor the rights of others.

**LIFE SUPPORT POLICY**

Vincotech products are not authorised for use as critical components in life support devices or systems without the express written approval of Vincotech.

As used herein:

1. Life support devices or systems are devices or systems which, (a) are intended for surgical implant into the body, or (b) support or sustain life, or (c) whose failure to perform when properly used in accordance with instructions for use provided in labelling can be reasonably expected to result in significant injury to the user.
2. A critical component is any component of a life support device or system whose failure to perform can be reasonably expected to cause the failure of the life support device or system, or to affect its safety or effectiveness.