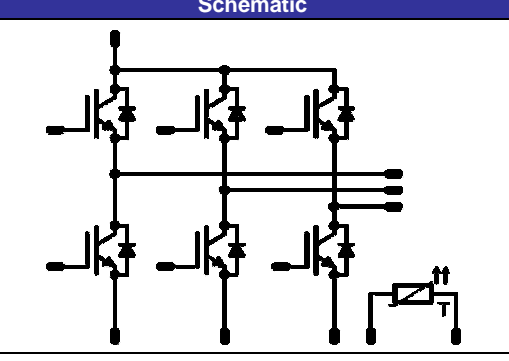

<i>flow90PACK 0</i>		1200V/15A	
<div style="border: 1px solid black; padding: 5px; margin-bottom: 5px;"> <p style="text-align: center; background-color: #000080; color: white; margin: 0;">Features</p> <ul style="list-style-type: none"> 90° PCB mounting for easy heat sink assembly Clip-in PCB mounting (optional) Open emitter for easy current sensing </div> <div style="border: 1px solid black; padding: 5px; margin-bottom: 5px;"> <p style="text-align: center; background-color: #000080; color: white; margin: 0;">Target Applications</p> <ul style="list-style-type: none"> Standard Drive Servo Drive Bookshelf Inverter </div> <div style="border: 1px solid black; padding: 5px;"> <p style="text-align: center; background-color: #000080; color: white; margin: 0;">Types</p> <ul style="list-style-type: none"> 10-R0126PA015SC-M628F40 10-RZ126PA015SC-M628F41 </div>	<div style="border: 1px solid black; padding: 5px; margin-bottom: 5px;"> <p style="text-align: center; background-color: #000080; color: white; margin: 0;"><i>flow90PACK 0</i></p>  </div> <div style="border: 1px solid black; padding: 5px;"> <p style="text-align: center; background-color: #000080; color: white; margin: 0;">Schematic</p>  </div>		

Maximum Ratings

$T_J=25^{\circ}\text{C}$, unless otherwise specified

Parameter	Symbol	Condition	Value	Unit
Inverter Transistor				
Collector-emitter break down voltage	V_{CE}		1200	V
DC collector current *	I_C	$T_J=T_{Jmax}$ $T_h=80^{\circ}\text{C}$ $T_c=80^{\circ}\text{C}$	23 25	A
Pulsed collector current	I_{Cpulse}	t_p limited by T_{Jmax}	45	A
Turn off safe operating area		$V_{CE} \leq 1200\text{V}$, $T_J \leq T_{op max}$	30	A
Power dissipation per IGBT *	P_{tot}	$T_J=T_{Jmax}$ $T_h=80^{\circ}\text{C}$ $T_c=80^{\circ}\text{C}$	69 104	W
Gate-emitter peak voltage	V_{GE}		± 20	V
Short circuit ratings	t_{SC} V_{CC}	$T_J \leq 150^{\circ}\text{C}$ $V_{GE} = 15\text{V}$	10 800	μs V
Maximum Junction Temperature	T_{Jmax}		175	$^{\circ}\text{C}$

* measured with phase-change material

Inverter Diode

Peak Repetitive Reverse Voltage	V_{RRM}		1200	V
DC forward current *	I_F	$T_J=T_{Jmax}$ $T_h=80^{\circ}\text{C}$ $T_c=80^{\circ}\text{C}$	23 30	A
Repetitive peak forward current	I_{FRM}	t_p limited by T_{Jmax}	30	A
Power dissipation per Diode *	P_{tot}	$T_J=T_{Jmax}$ $T_h=80^{\circ}\text{C}$ $T_c=80^{\circ}\text{C}$	53 81	W
Maximum Junction Temperature	T_{Jmax}		175	$^{\circ}\text{C}$

* measured with phase-change material

Maximum Ratings

$T_j=25^{\circ}\text{C}$, unless otherwise specified

Parameter	Symbol	Condition	Value	Unit
-----------	--------	-----------	-------	------

Thermal Properties

Storage temperature	T_{stg}		-40...+125	$^{\circ}\text{C}$
Operation temperature under switching condition	T_{op}		-40...+(T_{jmax} - 25)	$^{\circ}\text{C}$

Insulation Properties

Insulation voltage	V_{is}	t=2s DC voltage	4000	V
Creepage distance			min 12,7	mm
Clearance			min 10,93	mm
Comparative tracking index	CTI		>200	

Characteristic Values

Parameter	Symbol	Conditions					Value			Unit							
		$V_{GE}[V]$ or $V_{GS}[V]$	$V_r[V]$ or $V_{CE}[V]$ or $V_{DS}[V]$	$I_c[A]$ or $I_F[A]$ or $I_b[A]$	T_j	Min	Typ	Max									
Inverter Transistor																	
Gate emitter threshold voltage	$V_{GE(th)}$	$V_{CE}=V_{GE}$			0,0005	$T_j=25^\circ C$ $T_j=150^\circ C$	5	5,8	6,5	V							
Collector-emitter saturation voltage	$V_{CE(sat)}$		15		15	$T_j=25^\circ C$ $T_j=150^\circ C$	1,5	1,93 2,23	2,3	V							
Collector-emitter cut-off current incl. Diode	I_{CES}		0	1200		$T_j=25^\circ C$ $T_j=150^\circ C$			0,01	mA							
Gate-emitter leakage current	I_{GES}		20	0		$T_j=25^\circ C$ $T_j=150^\circ C$			200	nA							
Integrated Gate resistor	R_{gint}							none		Ω							
Turn-on delay time	$t_{d(on)}$	Rgoff=32 Ω Rgon=32 Ω	± 15	600	15	$T_j=25^\circ C$		86		ns							
Rise time	t_r					$T_j=150^\circ C$		85									
Turn-off delay time	$t_{d(off)}$					$T_j=25^\circ C$		34									
						$T_j=150^\circ C$		35									
Fall time	t_f					$T_j=25^\circ C$		202									
						$T_j=150^\circ C$		272									
Turn-on energy loss per pulse	E_{on}					$T_j=25^\circ C$		70									
		$T_j=150^\circ C$		124													
Turn-off energy loss per pulse	E_{off}	$T_j=25^\circ C$		1,18													
		$T_j=150^\circ C$		1,76													
Input capacitance	C_{ies}	f=1MHz	0	25		$T_j=25^\circ C$		900		pF							
								Output capacitance	C_{oss}		80						
Reverse transfer capacitance	C_{rss}										55						
								Gate charge	Q_{Gate}			15	960	15	$T_j=25^\circ C$		85
Thermal resistance chip to heatsink per chip	R_{thJH}							Phase-Change Material							1,38		K/W
Thermal resistance chip to heatsink per chip	R_{thJH}							Thermal grease thickness $\leq 50\mu m$ $\lambda = 1 W/mK$							1,63		K/W
Inverter Diode																	
Diode forward voltage	V_F				15	$T_j=25^\circ C$ $T_j=150^\circ C$	1,2	1,86 1,78	2,3	V							
Peak reverse recovery current	I_{RRM}	Rgon=32 Ω	± 15	600	15	$T_j=25^\circ C$		10		A							
Reverse recovery time	t_{rr}					$T_j=150^\circ C$		13									
						$T_j=25^\circ C$		297									
Reverse recovered charge	Q_{rr}					$T_j=150^\circ C$		508									
						$T_j=25^\circ C$		1,46									
Peak rate of fall of recovery current	$di(rec)max/dt$					$T_j=150^\circ C$		2,94									
						$T_j=25^\circ C$		58									
Reverse recovered energy	E_{rec}	$T_j=150^\circ C$		45													
		$T_j=25^\circ C$		0,57													
Thermal resistance chip to heatsink per chip	R_{thJH}	Phase-Change Material						1,78		K/W							
		Thermal grease thickness $\leq 50\mu m$ $\lambda = 1 W/mK$						2,09		K/W							
Thermistor																	
Rated resistance	R					$T_j=25^\circ C$		4700		Ω							
Deviation of R25	$\Delta R/R$					$T_j=25^\circ C$	-5		5	%							
Power dissipation	P					$T_j=25^\circ C$		200		mW							
Power dissipation constant						$T_j=25^\circ C$		2		mW/K							
B-value	$B_{(25/50)}$	Tol. $\pm 3\%$				$T_j=25^\circ C$		3500		K							
B-value	$B_{(25/100)}$					$T_j=25^\circ C$		3560		K							
Vincotech NTC Reference									G								

Output Inverter

Figure 1 Output inverter IGBT

Typical output characteristics

$I_C = f(V_{CE})$

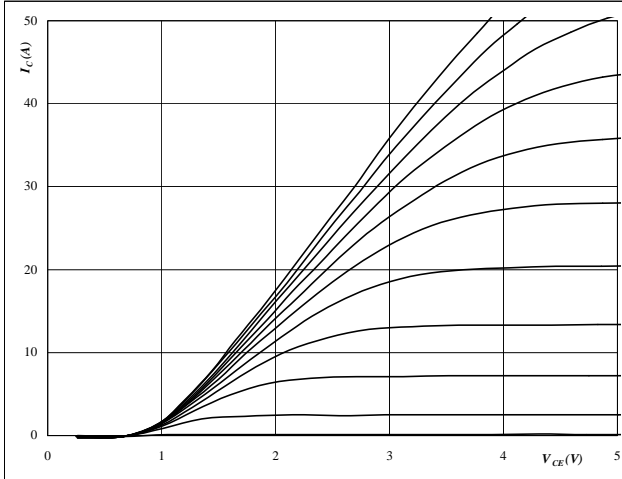

At
 $t_p = 250 \mu s$
 $T_j = 25 \text{ }^\circ C$
 V_{GE} from 7 V to 17 V in steps of 1 V

Figure 2 Output inverter IGBT

Typical output characteristics

$I_C = f(V_{CE})$

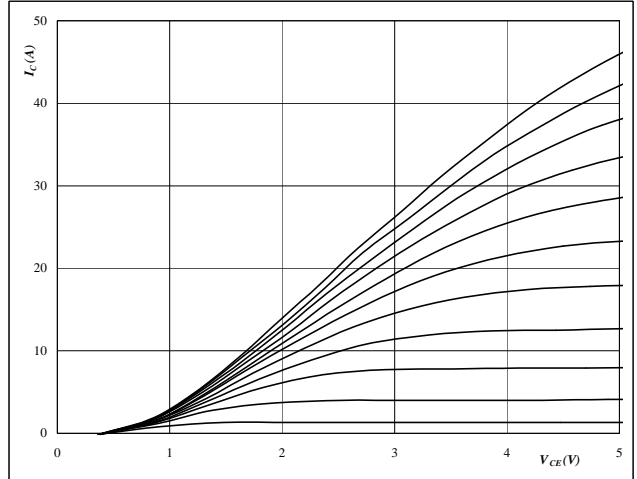

At
 $t_p = 250 \mu s$
 $T_j = 150 \text{ }^\circ C$
 V_{GE} from 7 V to 17 V in steps of 1 V

Figure 3 Output inverter IGBT

Typical transfer characteristics

$I_C = f(V_{GE})$

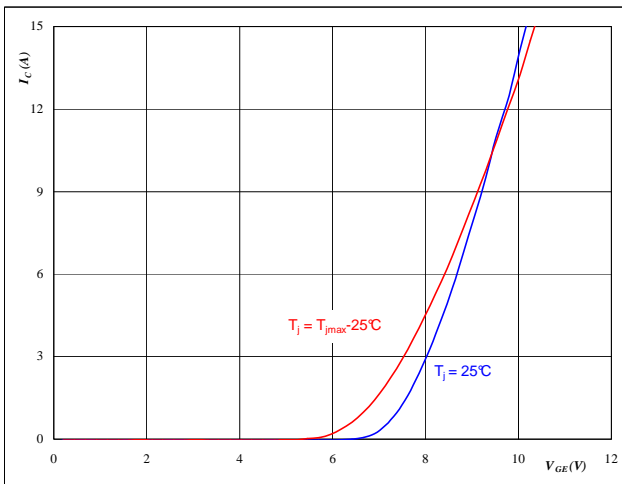

At
 $t_p = 250 \mu s$
 $V_{CE} = 10 \text{ V}$

Figure 4 Output inverter FWD

Typical diode forward current as a function of forward voltage

$I_F = f(V_F)$

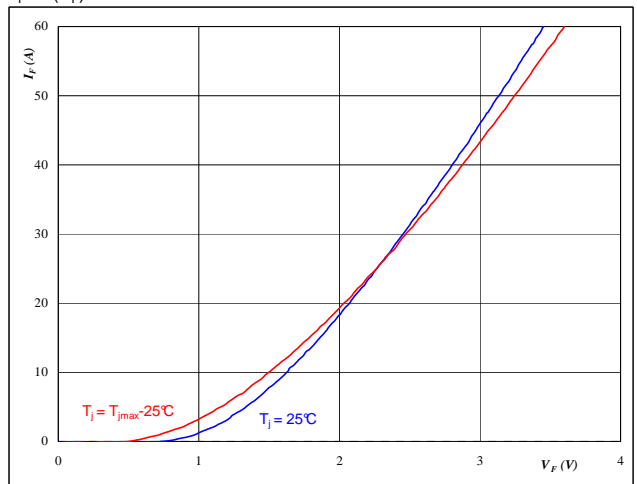

At
 $t_p = 250 \mu s$

Output Inverter

Figure 5 Output inverter IGBT

Typical switching energy losses
as a function of collector current

$$E = f(I_C)$$

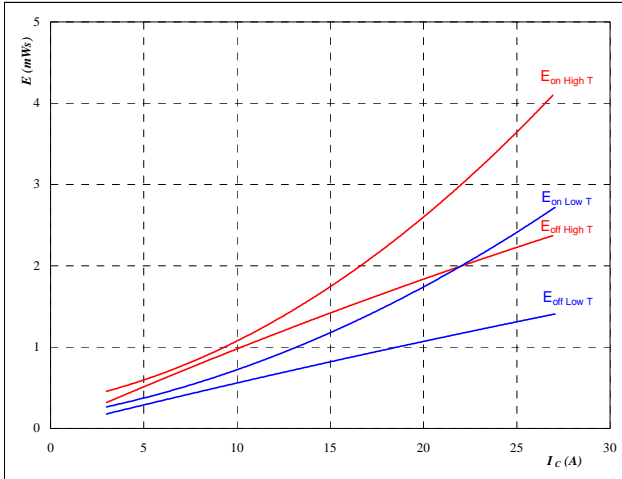

With an inductive load at

$T_J =$	25/150	°C
$V_{CE} =$	600	V
$V_{GE} =$	±15	V
$R_{gon} =$	32	Ω
$R_{goff} =$	32	Ω

Figure 6 Output inverter IGBT

Typical switching energy losses
as a function of gate resistor

$$E = f(R_G)$$

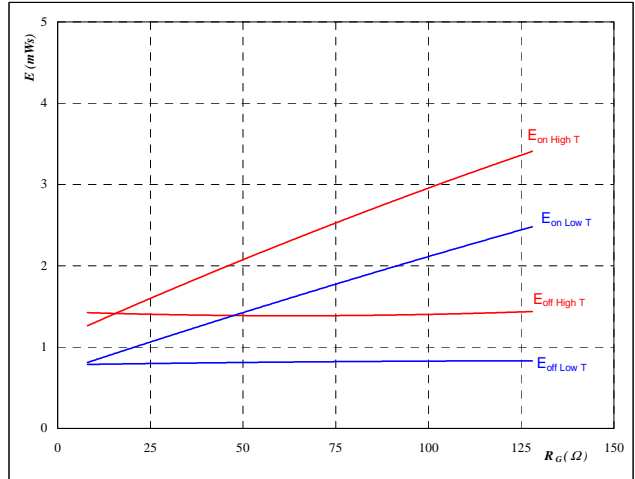

With an inductive load at

$T_J =$	25/150	°C
$V_{CE} =$	600	V
$V_{GE} =$	±15	V
$I_C =$	15	A

Figure 7 Output inverter FWD

Typical reverse recovery energy loss
as a function of collector current

$$E_{rec} = f(I_C)$$

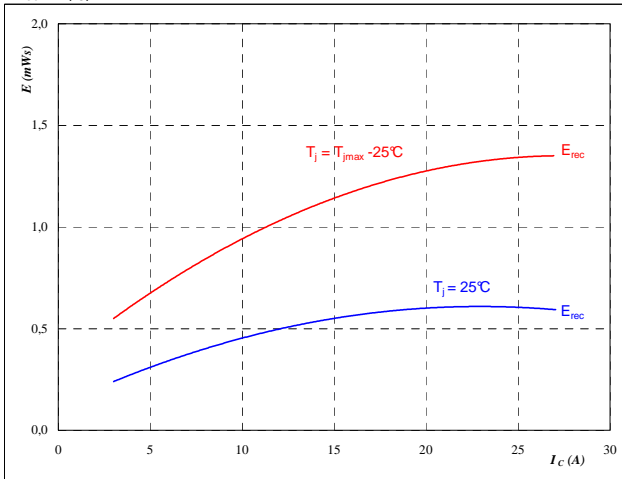

With an inductive load at

$T_J =$	25/150	°C
$V_{CE} =$	600	V
$V_{GE} =$	±15	V
$R_{gon} =$	32	Ω

Figure 8 Output inverter FWD

Typical reverse recovery energy loss
as a function of gate resistor

$$E_{rec} = f(R_G)$$

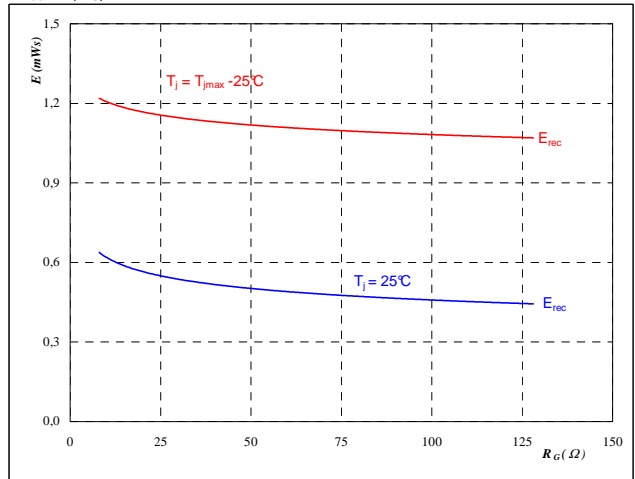

With an inductive load at

$T_J =$	25/150	°C
$V_{CE} =$	600	V
$V_{GE} =$	±15	V
$I_C =$	15	A

Output Inverter

Figure 9 Output inverter IGBT

Typical switching times as a function of collector current

$$t = f(I_C)$$

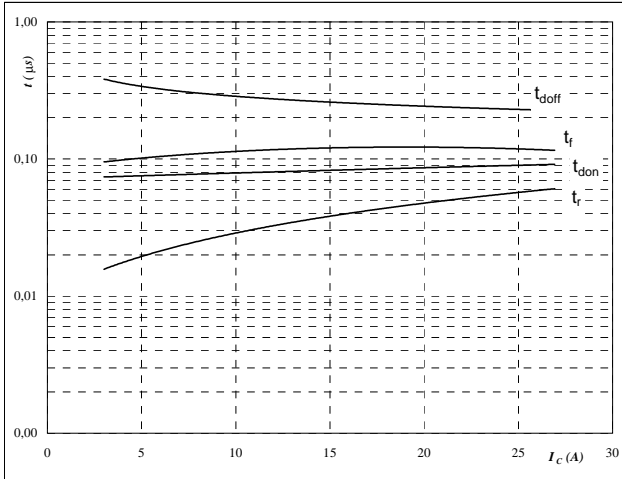

With an inductive load at

$T_J =$	150	°C
$V_{CE} =$	600	V
$V_{GE} =$	±15	V
$R_{gon} =$	32	Ω
$R_{goff} =$	32	Ω

Figure 10 Output inverter IGBT

Typical switching times as a function of gate resistor

$$t = f(R_G)$$

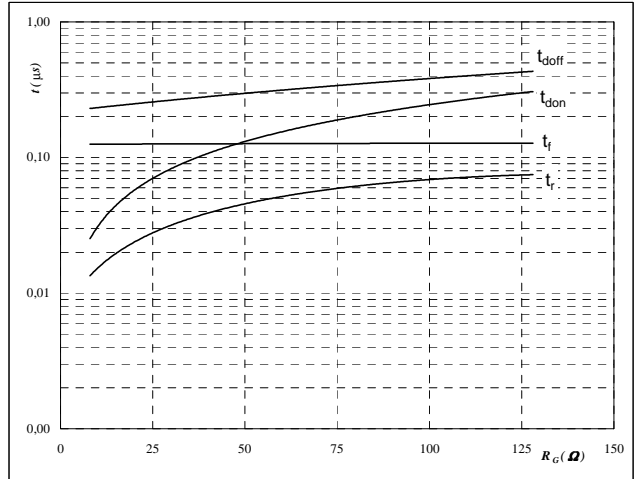

With an inductive load at

$T_J =$	150	°C
$V_{CE} =$	600	V
$V_{GE} =$	±15	V
$I_C =$	15	A

Figure 11 Output inverter FWD

Typical reverse recovery time as a function of collector current

$$t_{rr} = f(I_C)$$

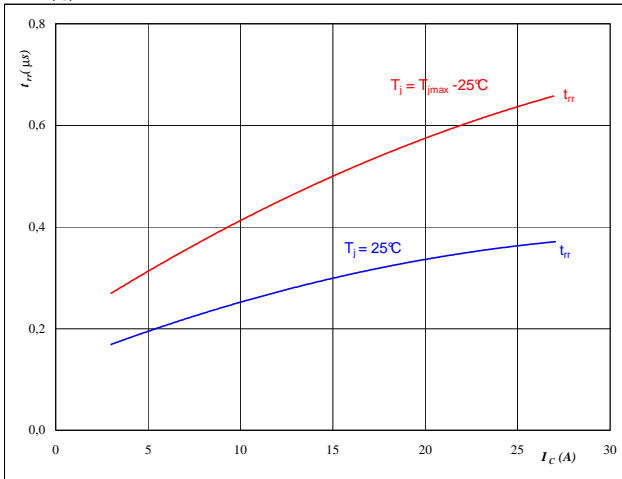

At

$T_J =$	25/150	°C
$V_{CE} =$	600	V
$V_{GE} =$	±15	V
$R_{gon} =$	32	Ω

Figure 12 Output inverter FWD

Typical reverse recovery time as a function of IGBT turn on gate resistor

$$t_{rr} = f(R_{gon})$$

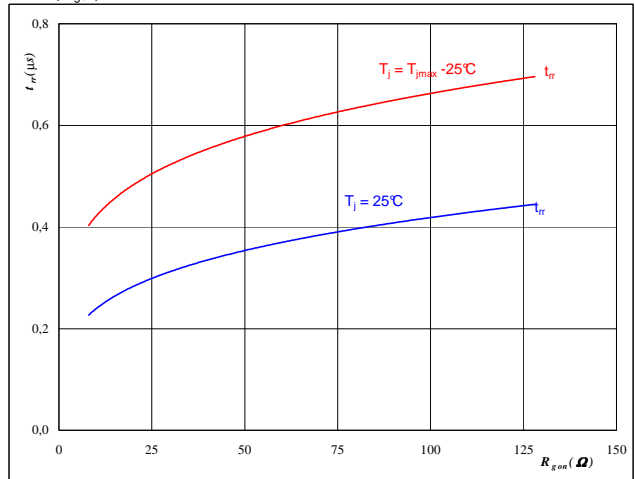

At

$T_J =$	25/150	°C
$V_R =$	600	V
$I_F =$	15	A
$V_{GE} =$	±15	V

Output Inverter

Figure 13 Output inverter FWD

Typical reverse recovery charge as a function of collector current

$$Q_{rr} = f(I_C)$$

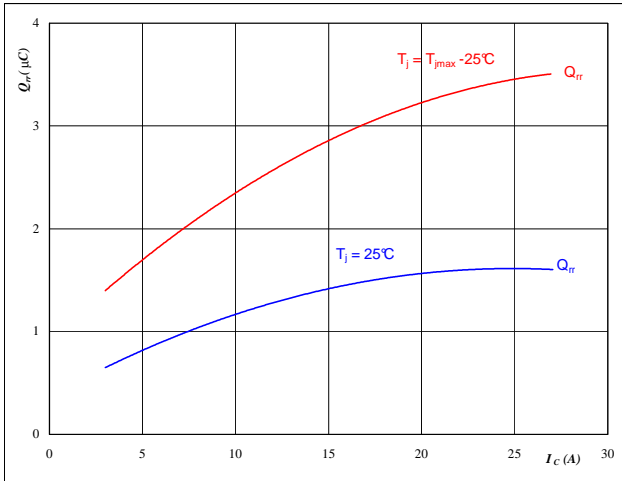

At
 $T_j = 25/150 \text{ } ^\circ\text{C}$
 $V_{CE} = 600 \text{ V}$
 $V_{GE} = \pm 15 \text{ V}$
 $R_{gon} = 32 \text{ } \Omega$

Figure 14 Output inverter FWD

Typical reverse recovery charge as a function of IGBT turn on gate resistor

$$Q_{rr} = f(R_{gon})$$

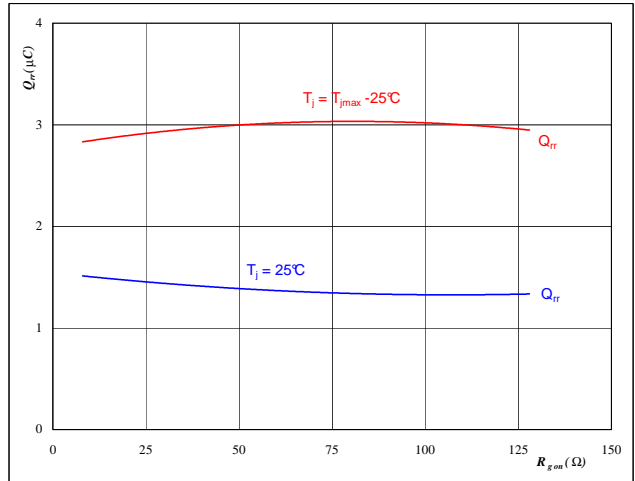

At
 $T_j = 25/150 \text{ } ^\circ\text{C}$
 $V_R = 600 \text{ V}$
 $I_F = 15 \text{ A}$
 $V_{GE} = \pm 15 \text{ V}$

Figure 15 Output inverter FWD

Typical reverse recovery current as a function of collector current

$$I_{RRM} = f(I_C)$$

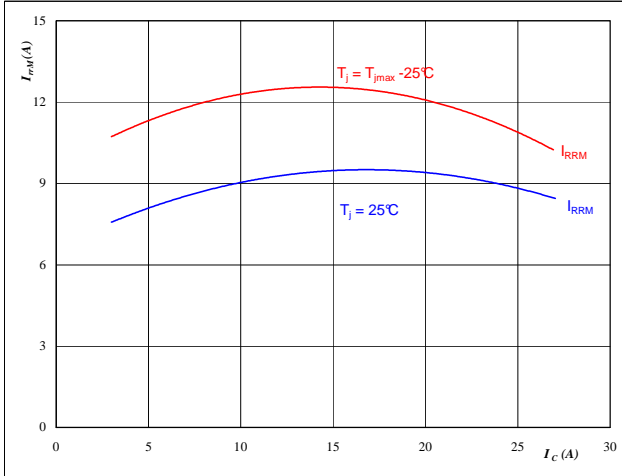

At
 $T_j = 25/150 \text{ } ^\circ\text{C}$
 $V_{CE} = 600 \text{ V}$
 $V_{GE} = \pm 15 \text{ V}$
 $R_{gon} = 32 \text{ } \Omega$

Figure 16 Output inverter FWD

Typical reverse recovery current as a function of IGBT turn on gate resistor

$$I_{RRM} = f(R_{gon})$$

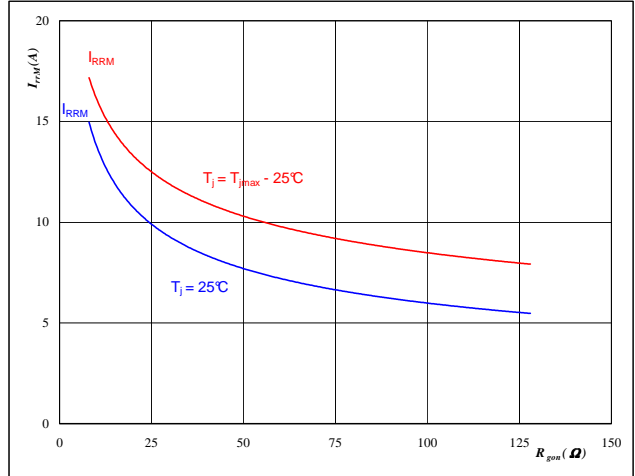

At
 $T_j = 25/150 \text{ } ^\circ\text{C}$
 $V_R = 600 \text{ V}$
 $I_F = 15 \text{ A}$
 $V_{GE} = \pm 15 \text{ V}$

Output Inverter

Figure 17 Output inverter FWD

Typical rate of fall of forward and reverse recovery current as a function of collector current

$$di_o/dt, di_{rec}/dt = f(I_c)$$

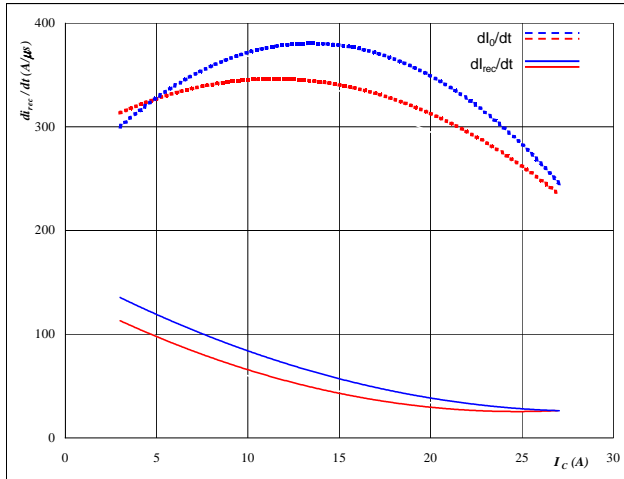

At
 $T_j = 25/150 \text{ } ^\circ\text{C}$
 $V_{CE} = 600 \text{ V}$
 $V_{GE} = \pm 15 \text{ V}$
 $R_{gon} = 32 \text{ } \Omega$

Figure 18 Output inverter FWD

Typical rate of fall of forward and reverse recovery current as a function of IGBT turn on gate resistor

$$di_o/dt, di_{rec}/dt = f(R_{gon})$$

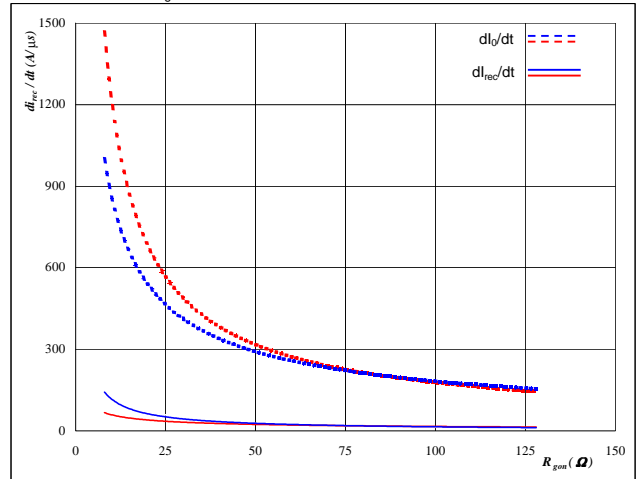

At
 $T_j = 25/150 \text{ } ^\circ\text{C}$
 $V_R = 600 \text{ V}$
 $I_F = 15 \text{ A}$
 $V_{GE} = \pm 15 \text{ V}$

Figure 19 Output inverter IGBT

IGBT transient thermal impedance as a function of pulse width

$$Z_{thJH} = f(t_p)$$

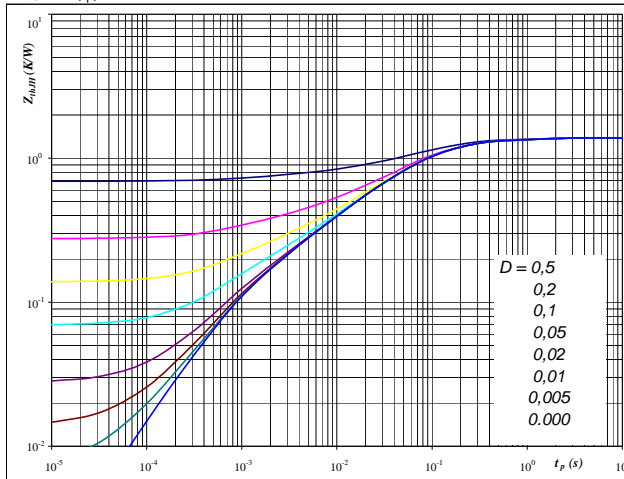

At
 $D = t_p / T$
 $R_{thJH} = 1,38 \text{ K/W}$ $R_{thJH} = 1,63 \text{ K/W}$

IGBT thermal model values

Phase change interface		Thermal grease	
R (C/W)	Tau (s)	R (C/W)	Tau (s)
0,14	7,1E-01	0,16	7,1E-01
0,55	1,0E-01	0,65	1,0E-01
0,40	3,6E-02	0,47	3,6E-02
0,19	7,0E-03	0,22	7,0E-03
0,10	9,2E-04	0,12	9,2E-04

Figure 20 Output inverter FWD

FWD transient thermal impedance as a function of pulse width

$$Z_{thJH} = f(t_p)$$

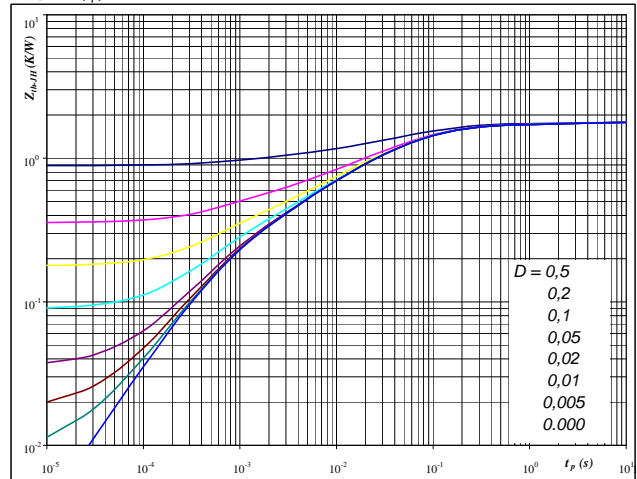

At
 $D = t_p / T$
 $R_{thJH} = 1,78 \text{ K/W}$ $R_{thJH} = 2,09 \text{ K/W}$

FWD thermal model values

Phase change interface		Thermal grease	
R (C/W)	Tau (s)	R (C/W)	Tau (s)
0,07	2,6E+00	0,08	2,6E+00
0,12	3,9E-01	0,15	3,9E-01
0,72	6,9E-02	0,84	6,9E-02
0,45	1,7E-02	0,53	1,7E-02
0,24	3,8E-03	0,29	3,8E-03
0,18	6,4E-04	0,21	6,4E-04

Output Inverter

Figure 21 Output inverter IGBT

Power dissipation as a function of heatsink temperature

$$P_{tot} = f(T_h)$$

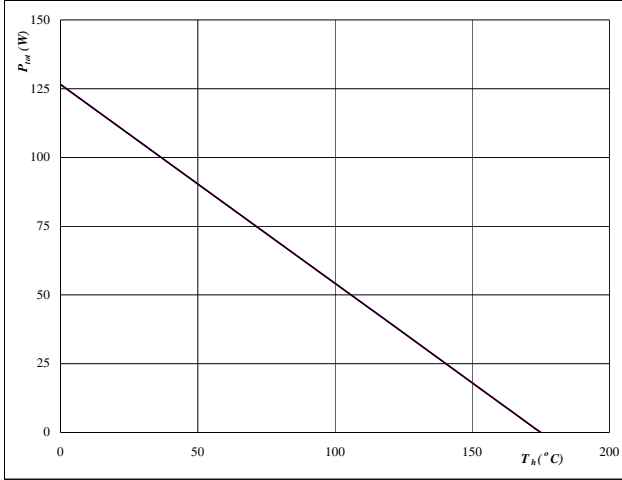
At
 $T_j = 175 \text{ } ^\circ\text{C}$
Figure 22 Output inverter IGBT

Collector current as a function of heatsink temperature

$$I_C = f(T_h)$$

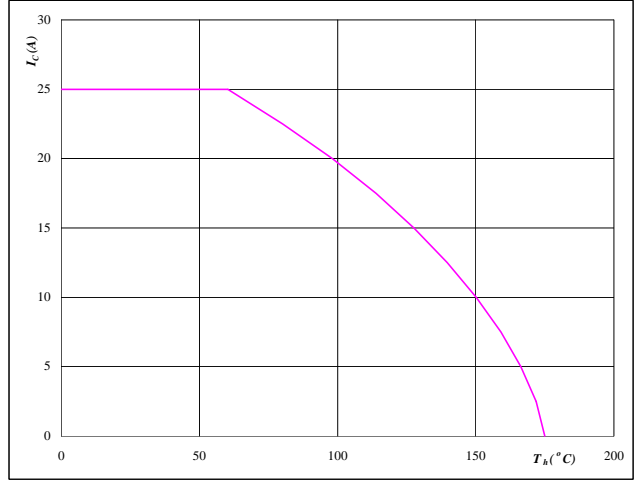
At
 $T_j = 175 \text{ } ^\circ\text{C}$
 $V_{GE} = 15 \text{ V}$
Figure 23 Output inverter FWD

Power dissipation as a function of heatsink temperature

$$P_{tot} = f(T_h)$$

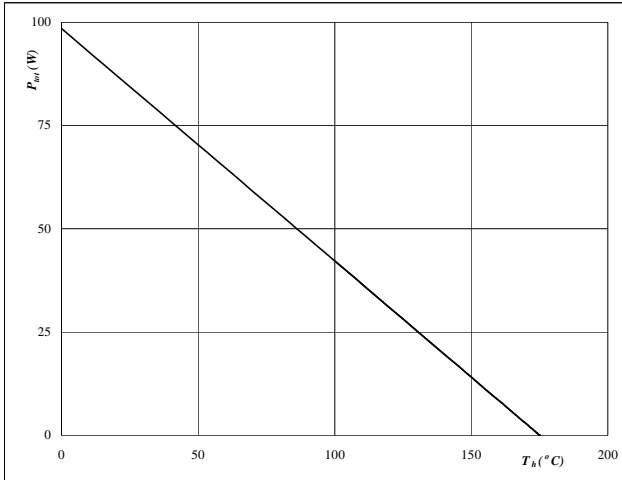
At
 $T_j = 175 \text{ } ^\circ\text{C}$
Figure 24 Output inverter FWD

Forward current as a function of heatsink temperature

$$I_F = f(T_h)$$

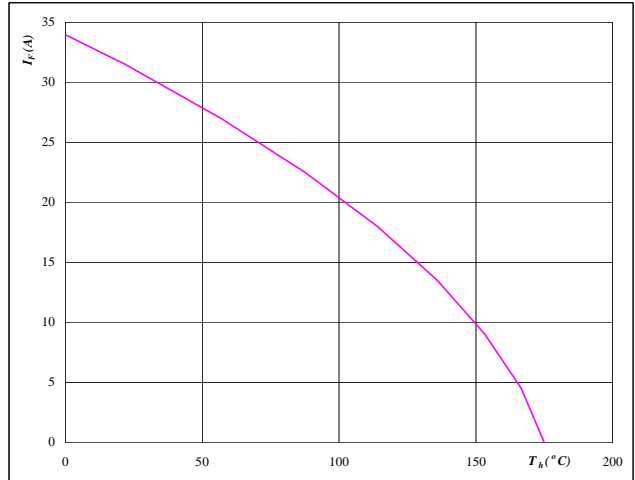
At
 $T_j = 175 \text{ } ^\circ\text{C}$

Output Inverter

Figure 25 Output inverter IGBT

Safe operating area as a function of collector-emitter voltage
 $I_C = f(V_{CE})$

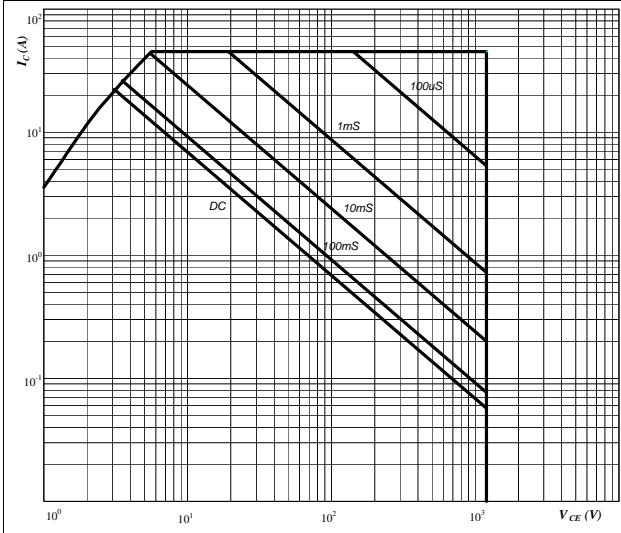

At
 D = single pulse
 $T_h = 80$ °C
 $V_{GE} = \pm 15$ V
 $T_j = T_{jmax}$ °C

Figure 26 Output inverter IGBT

Gate voltage vs Gate charge

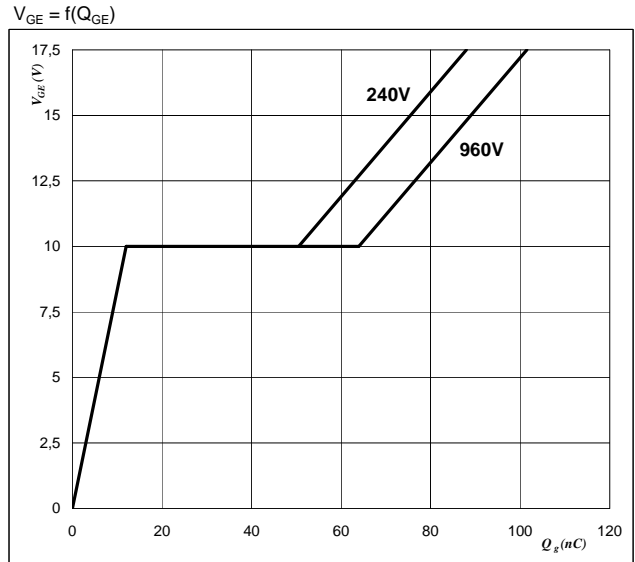

At
 $I_C = 15$ A

Figure 27 Output inverter IGBT

Short circuit withstand time as a function of gate-emitter voltage
 $t_{sc} = f(V_{GE})$

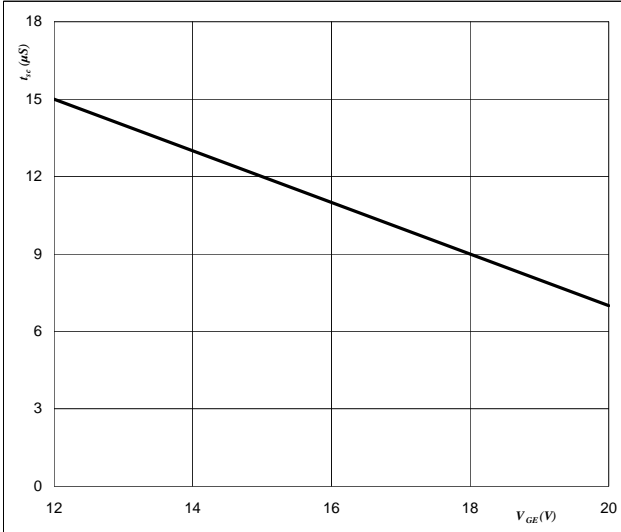

At
 $V_{CE} = 1200$ V
 $T_j \leq 175$ °C

Figure 28 Output inverter IGBT

Typical short circuit collector current as a function of gate-emitter voltage
 $V_{GE} = f(Q_{GE})$

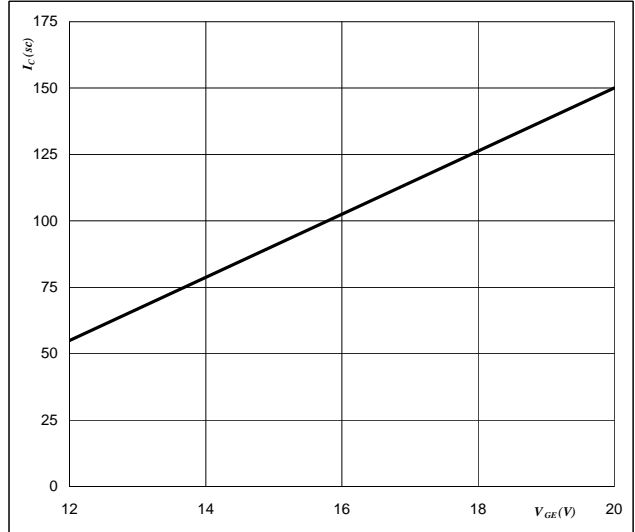

At
 $V_{CE} \leq 600$ V
 $T_j = 175$ °C

Figure 29 IGBT

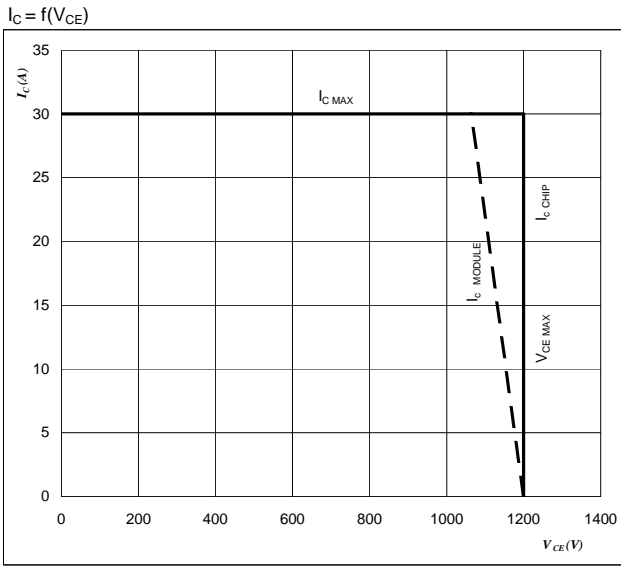
Reverse bias safe operating area

At

$$T_J = T_{jmax} - 25 \quad ^\circ\text{C}$$

$$U_{ocmin} = U_{ccplus}$$

Switching mode : 3 level switching

Thermistor

Figure 1 Thermistor

**Typical NTC characteristic
as a function of temperature**

$$R_T = f(T)$$

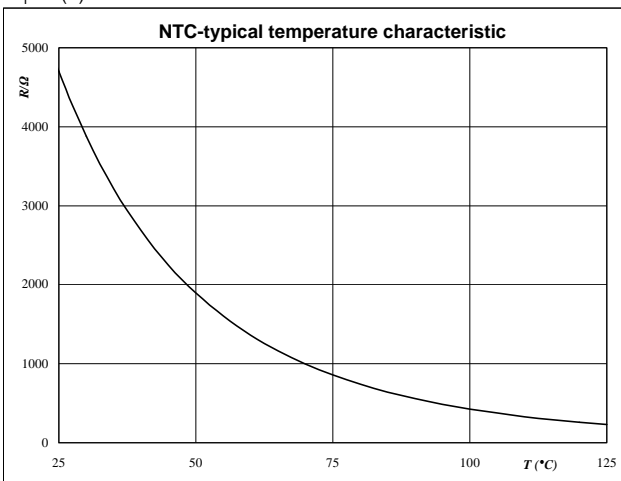

Switching Definitions Output Inverter

General conditions	
T_j	= 150 °C
R_{gon}	= 32 Ω
R_{goff}	= 32 Ω

Figure 1 Output inverter IGBT

Turn-off Switching Waveforms & definition of t_{doff} , t_{Eoff}
(t_{Eoff} = integrating time for E_{off})

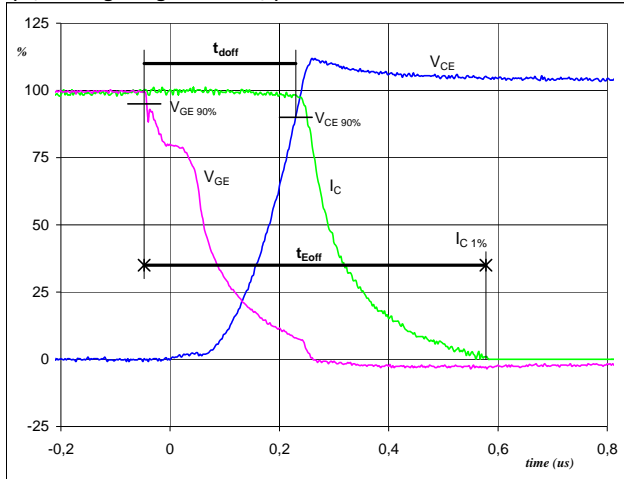

V_{GE} (0%) =	-15	V
V_{GE} (100%) =	15	V
V_C (100%) =	600	V
I_C (100%) =	15	A
t_{doff} =	0,27	μ s
t_{Eoff} =	0,63	μ s

Figure 2 Output inverter IGBT

Turn-on Switching Waveforms & definition of t_{don} , t_{Eon}
(t_{Eon} = integrating time for E_{on})

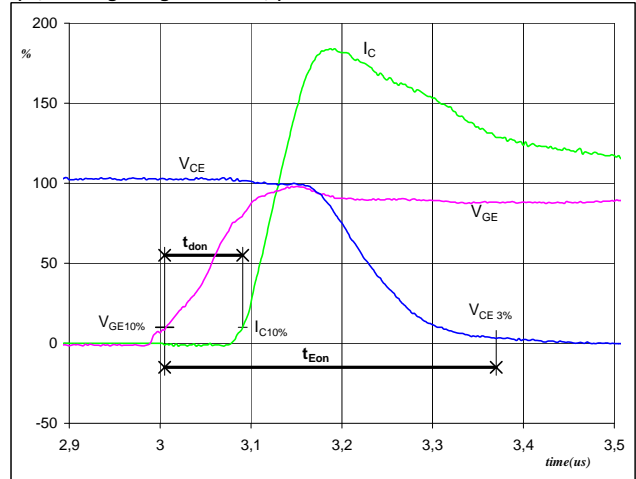

V_{GE} (0%) =	-15	V
V_{GE} (100%) =	15	V
V_C (100%) =	600	V
I_C (100%) =	15	A
t_{don} =	0,09	μ s
t_{Eon} =	0,36	μ s

Figure 3 Output inverter IGBT

Turn-off Switching Waveforms & definition of t_f

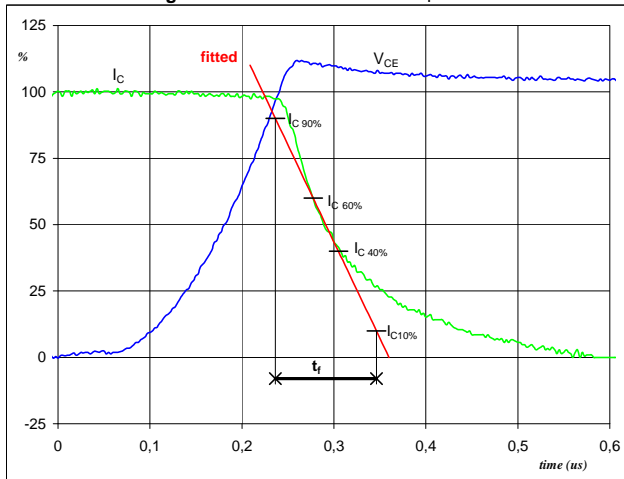

V_C (100%) =	600	V
I_C (100%) =	15	A
t_f =	0,12	μ s

Figure 4 Output inverter IGBT

Turn-on Switching Waveforms & definition of t_r

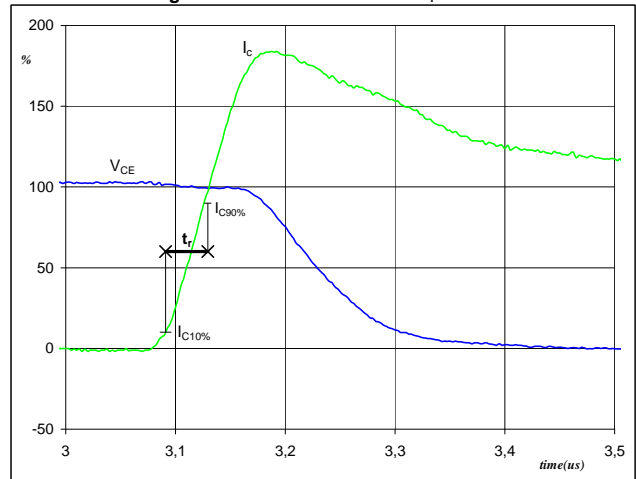

V_C (100%) =	600	V
I_C (100%) =	15	A
t_r =	0,04	μ s

Switching Definitions Output Inverter

Figure 5 Output inverter IGBT
Turn-off Switching Waveforms & definition of t_{Eoff}

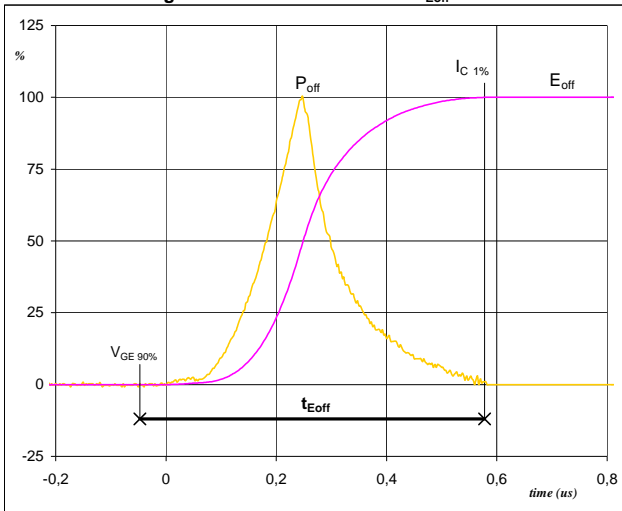

$P_{off} (100\%) = 8,98 \text{ kW}$
 $E_{off} (100\%) = 1,39 \text{ mJ}$
 $t_{Eoff} = 0,63 \text{ } \mu\text{s}$

Figure 6 Output inverter IGBT
Turn-on Switching Waveforms & definition of t_{Eon}

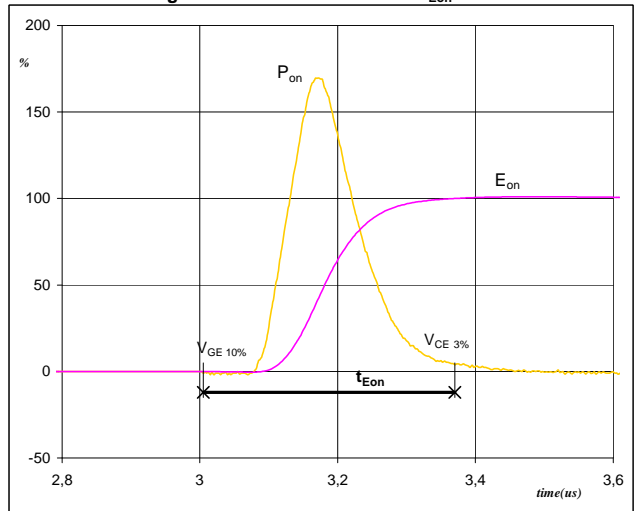

$P_{on} (100\%) = 8,98 \text{ kW}$
 $E_{on} (100\%) = 1,76 \text{ mJ}$
 $t_{Eon} = 0,36 \text{ } \mu\text{s}$

Figure 7 Output inverter IGBT
Gate voltage vs Gate charge (measured)

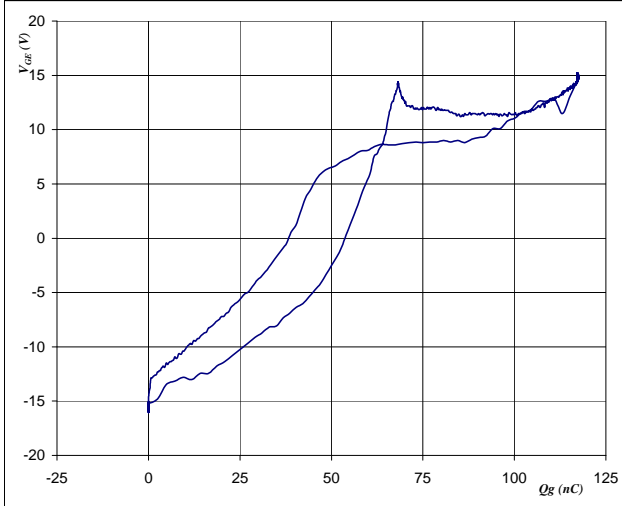

$V_{GEoff} = -15 \text{ V}$
 $V_{GEon} = 15 \text{ V}$
 $V_C (100\%) = 600 \text{ V}$
 $I_C (100\%) = 15 \text{ A}$
 $Q_g = 117,46 \text{ nC}$

Figure 8 Output inverter FWD
Turn-off Switching Waveforms & definition of t_{rr}

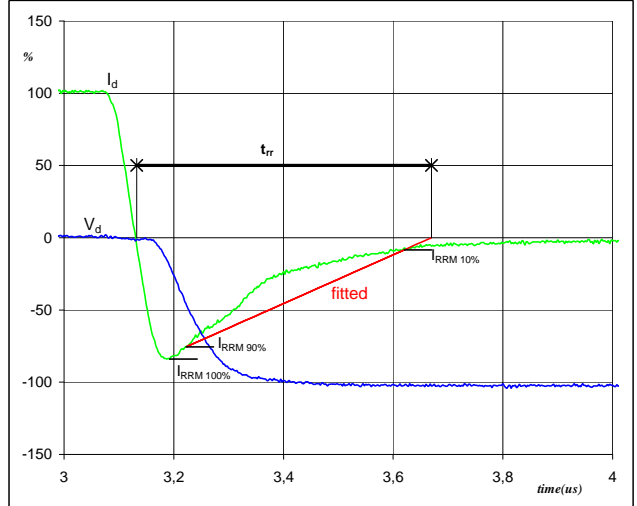

$V_d (100\%) = 600 \text{ V}$
 $I_d (100\%) = 15 \text{ A}$
 $I_{RRM} (100\%) = -13 \text{ A}$
 $t_{rr} = 0,51 \text{ } \mu\text{s}$

Switching Definitions Output Inverter

Figure 9 Output inverter FWD

Turn-on Switching Waveforms & definition of t_{Qrr}
 (t_{Qrr} = integrating time for Q_{rr})

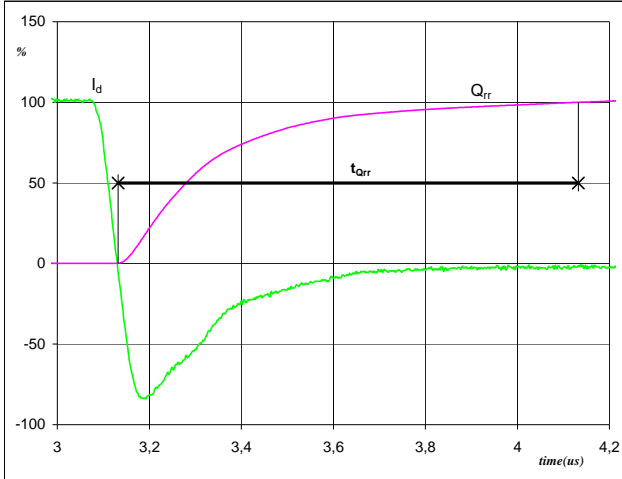

I_d (100%) =	15	A
Q_{rr} (100%) =	2,94	μC
t_{Qrr} =	1,00	μs

Figure 10 Output inverter FWD

Turn-on Switching Waveforms & definition of t_{Erec}
 (t_{Erec} = integrating time for E_{rec})

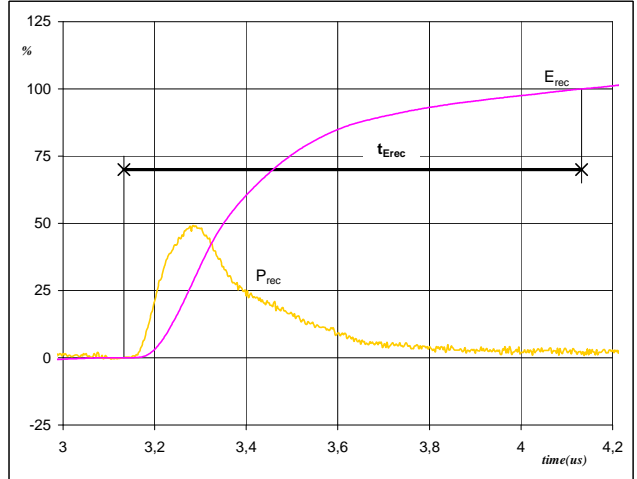

P_{rec} (100%) =	8,98	kW
E_{rec} (100%) =	1,18	mJ
t_{Erec} =	1,00	μs

Ordering Code and Marking - Outline - Pinout
Ordering Code & Marking

Version	Ordering Code	in DataMatrix as	in packaging barcode as
without thermal paste ,housing without clips	10-RZ126PA015SC-M628F41	M628F41	M628F41
without thermal paste ,housing with clips	10-R0126PA015SC-M628F40	M628F40	M628F40

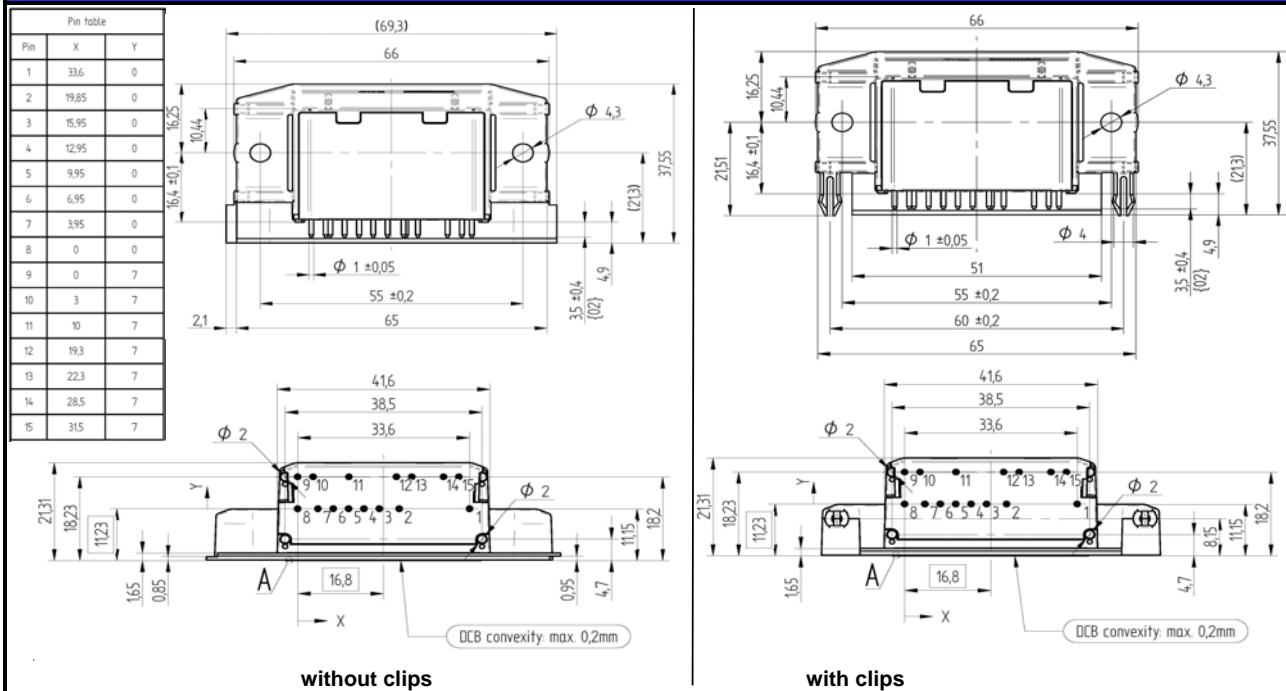
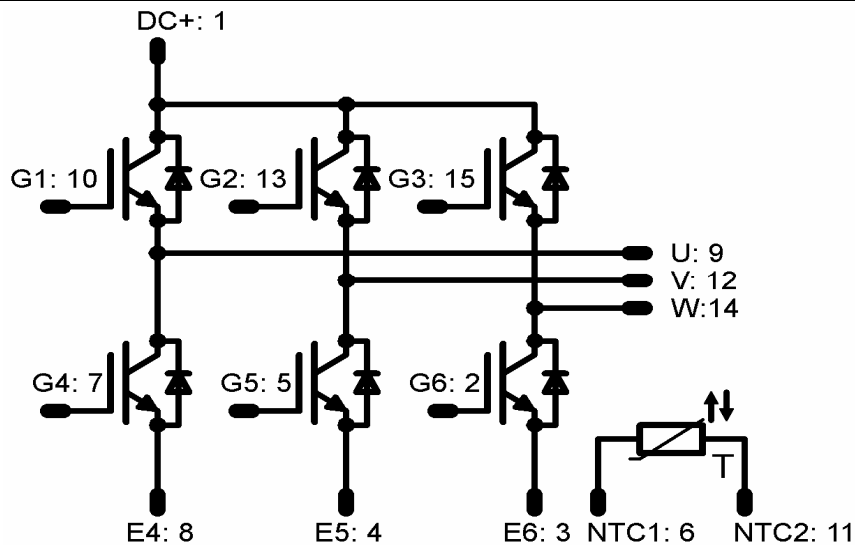
Outline

Pinout

DISCLAIMER

The information given in this datasheet describes the type of component and does not represent assured characteristics. For tested values please contact Vincotech. Vincotech reserves the right to make changes without further notice to any products herein to improve reliability, function or design. Vincotech does not assume any liability arising out of the application or use of any product or circuit described herein; neither does it convey any license under its patent rights, nor the rights of others.

LIFE SUPPORT POLICY

Vincotech products are not authorised for use as critical components in life support devices or systems without the express written approval of Vincotech.

As used herein:

1. Life support devices or systems are devices or systems which, (a) are intended for surgical implant into the body, or (b) support or sustain life, or (c) whose failure to perform when properly used in accordance with instructions for use provided in labelling can be reasonably expected to result in significant injury to the user.
2. A critical component is any component of a life support device or system whose failure to perform can be reasonably expected to cause the failure of the life support device or system, or to affect its safety or effectiveness.