

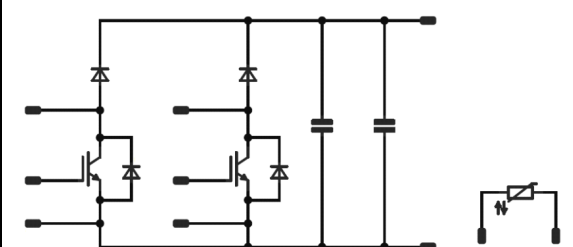

Vincotech

<i>flow 2xBOOST 0</i>	650 V / 30 A
<div style="background-color: #eee; padding: 2px; margin-bottom: 5px;">Features</div> <ul style="list-style-type: none"> High efficient dual booster Included capacitor Very high switching frequency Very compact design 	<div style="background-color: #eee; padding: 2px; margin-bottom: 5px;">flow 0 12mm housing</div> <div style="text-align: center;">  </div>
<div style="background-color: #eee; padding: 2px; margin-bottom: 5px;">Target applications</div> <ul style="list-style-type: none"> Solar Inverter 	<div style="background-color: #eee; padding: 2px; margin-bottom: 5px;">Schematic</div> <div style="text-align: center;">  </div>
<div style="background-color: #eee; padding: 2px; margin-bottom: 5px;">Types</div> <ul style="list-style-type: none"> 10-FZ07B2A030SM02-M575L48 	

Maximum Ratings

$T_j=25^\circ\text{C}$, unless otherwise specified

Parameter	Symbol	Condition	Value	Unit
Boost Switch				
Collector-emitter voltage	V_{CES}		650	V
Collector current	I_C	$T_j=T_{jmax}$ $T_s=80^\circ\text{C}$	28	A
Repetitive peak collector current	I_{CRM}	t_p limited by T_{jmax}	90	A
Total power dissipation	P_{tot}	$T_j=T_{jmax}$ $T_s=80^\circ\text{C}$	57	W
Gate-emitter voltage	V_{GES}		± 20	V
Maximum Junction Temperature	T_{jmax}		175	$^\circ\text{C}$



Vincotech

Parameter	Symbol	Conditions	Value	Unit
Boost Diode				
Peak Repetitive Reverse Voltage	V_{RRM}		650	V
Continuous (direct) forward current	I_F	$T_j=T_{jmax}$ $T_h=80^{\circ}C$	29	A
Repetitive peak forward current	I_{FRM}		180	A
Total power dissipation	P_{tot}	$T_j=T_{jmax}$ $T_h=80^{\circ}C$	52	W
Maximum Junction Temperature	T_{jmax}		175	$^{\circ}C$

Parameter	Symbol	Conditions	Value	Unit
Boost Inverse Diode				
Peak Repetitive Reverse Voltage	V_{RRM}		650	V
Continuous (direct) forward current	I_F	$T_j=T_{jmax}$ $T_h=80^{\circ}C$	30	A
Surge (non-repetitive) forward current	I_{FSM}	50Hz Single Half Sine Wave	150	A
Total power dissipation	P_{tot}	$T_j=T_{jmax}$ $T_h=80^{\circ}C$	58	W
Maximum Junction Temperature	T_{jmax}		175	$^{\circ}C$

Parameter	Symbol	Conditions	Value	Unit
DC Link Capacitor				
Maximum DC voltage	V_{MAX}		1000	V
Operation Temperature	T_{op}		-55...+125	$^{\circ}C$

Module Properties

Parameter	Symbol	Conditions	Value	Unit
-----------	--------	------------	-------	------

Thermal Properties

Storage temperature	T_{stg}		-40...+125	$^{\circ}C$
Operation Junction Temperature	T_{jop}		-40...+($T_{jmax} - 25$)	$^{\circ}C$

Isolation Properties

Isolation voltage	V_{isol}	DC voltage	$t_p=2s$	4000	V
Creepage distance				min 12,7	mm
Clearance				9,22	mm
Comparative Tracking Index	CTI			>200	



Vincotech

Characteristic Values

Boost Switch

Parameter	Symbol	Conditions					Value			Unit
		V_{GE} [V]	V_{CE} [V]	I_C [A]	T_j [°C]	Min	Typ	Max		

Static

Gate-emitter threshold voltage	$V_{GE(th)}$	$V_{GE}=V_{CE}$			0,0003	25 125	3,3	4	4,7	V
Collector-emitter saturation voltage	V_{CEsat}		15		30	25 125 150		1,69 1,92	2,22	V
Collector-emitter cut-off current	I_{CES}		0	650		25 125			40	μA
Gate-emitter leakage current	I_{GES}		20	0		25 125			120	nA
Internal gate resistance	r_g							none		Ω
Input capacitance	C_{ies}	f=1MHz	0	25		25		2100		pF
Reverse transfer capacitance	C_{res}							7,7		

Thermal

Thermal resistance junction to sink	$R_{th(j-s)}$	Phase-Change Material $\lambda=3,4W/mK$						1,67		K/W
-------------------------------------	---------------	--	--	--	--	--	--	------	--	-----

IGBT Switching

Turn-on delay time	$t_{d(on)}$	$R_{goff} = 16 \Omega$ $R_{gon} = 16 \Omega$	15/0	400	30	25		22		ns
Rise time	t_r					125		21		
Turn-off delay time	$t_{d(off)}$					25		6		
Fall time	t_f					125		8		
Turn-on energy (per pulse)	E_{on}	$Q_{rFWD} = 0,3 \mu C$ $Q_{rFWD} = 1,1 \mu C$				25		158		mWs
Turn-off energy (per pulse)	E_{off}					125		175		
						25		3		
						125		5		
						25		0,385		
						125		0,512		
						25		0,138		
						125		0,252		



Vincotech

Boost Diode

Parameter	Symbol	Conditions					Value			Unit
				V_r [V]	I_F [A]	T_j [°C]	Min	Typ	Max	

Static

Forward voltage	V_F				30	25 125 150		2,46 2,03 -	2,6	V
Reverse leakage current	I_r			665		25 150			10 -	μ A

Thermal

Thermal resistance junction to sink	$R_{th(j-s)}$	Phase-Change Material $\lambda=3,4W/mK$						1,83		K/W
-------------------------------------	---------------	--	--	--	--	--	--	------	--	-----

FWD Switching

Peak recovery current	I_{RRM}	$di/dt = 4188 A/\mu s$ $di/dt = 3749 A/\mu s$	15/0	400	30	25		28		A
Reverse recovery time	t_{rr}					125		36		ns
Recovered charge	Q_r					25		17		μ C
Reverse recovered energy	E_{rec}					125		77		mWs
Peak rate of fall of recovery current	$(di_{rr}/dt)_{max}$					25		0,336		A/ μ s
		125		1,091						
		25		0,040						
		125		0,251						
		25		6280						
		125		2364						

Boost Inverse Diode

Parameter	Symbol	Conditions					Value			Unit
				V_r [V]	I_F [A]	T_j [°C]	Min	Typ	Max	

Static

Forward voltage	V_F				15	25 125 150		2,48 1,73	2,93	V
Reverse leakage current	I_r			650		25 150			10	μ A

Thermal

Thermal resistance junction to sink	$R_{th(j-s)}$	Phase-Change Material $\lambda=3,4W/mK$						1,65		K/W
-------------------------------------	---------------	--	--	--	--	--	--	------	--	-----



Vincotech

DC Link Capacitor

Parameter	Symbol	Conditions					Value			Unit
						T_j [°C]	Min	Typ	Max	
Static										
Capacitance per leg	C							47		nF
Tolerance							-10		+10	%

Thermistor

Parameter	Symbol	Conditions					Value			Unit
			V_{GE} [V]	V_{CE} [V]	I_C [A]	T_{jl} [°C]	Min	Typ	Max	
Rated resistance	R					25		22		kΩ
Deviation of R100	$\Delta_{R/R}$	R100=1486 Ω				100	-12		+12	%
Power dissipation	P					25		200		mW
Power dissipation constant						25		2		mW/K
B-value	$B_{(25/50)}$	Tol. ±3%				25		3950		K
B-value	$B_{(25/100)}$	Tol. ±3%				25		3998		K
Vincotech NTC Reference									B	



Boost Switch Characteristics

Typical output characteristics IGBT

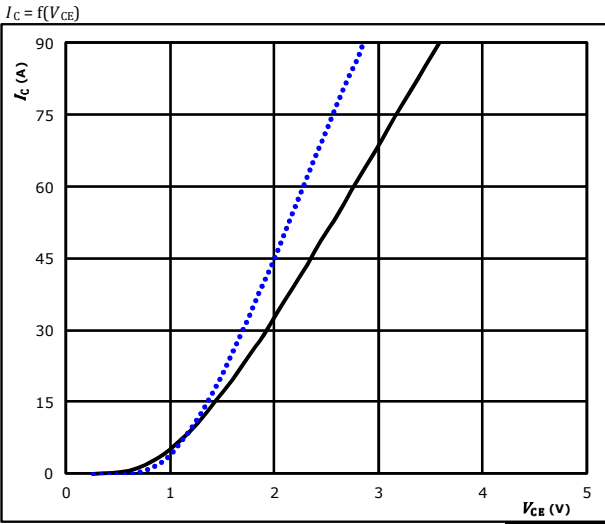

$t_p = 250 \mu s$
 $V_{GE} = 15 V$
 25 °C
 125 °C ———
 150 °C - - - -

Typical output characteristics IGBT

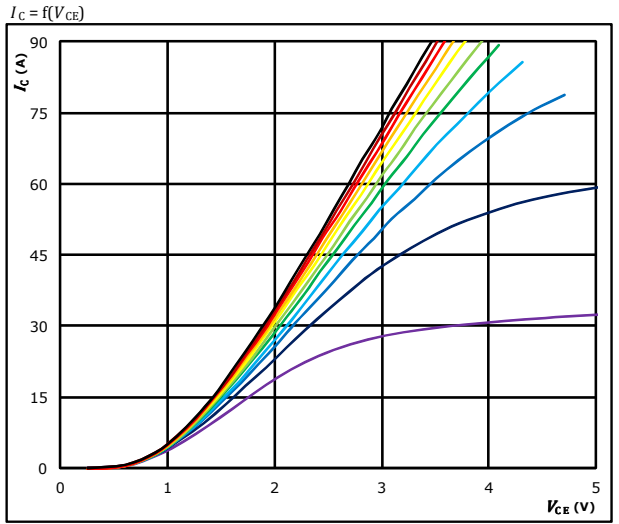

$t_p = 250 \mu s$
 $T_j = 125 \text{ } ^\circ C$
 V_{GE} from 7 V to 17 V in steps of 1 V

Typical transfer characteristics IGBT

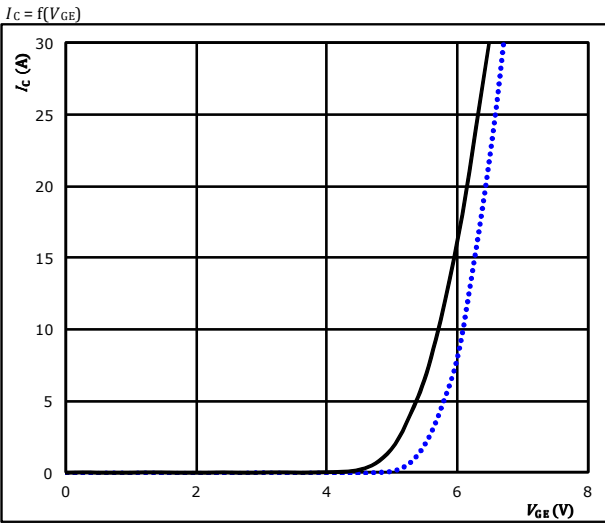

$t_p = 100 \mu s$
 $V_{CE} = 10 V$
 25 °C
 125 °C ———
 150 °C - - - -

Transient Thermal Impedance as function of Pulse duration IGBT

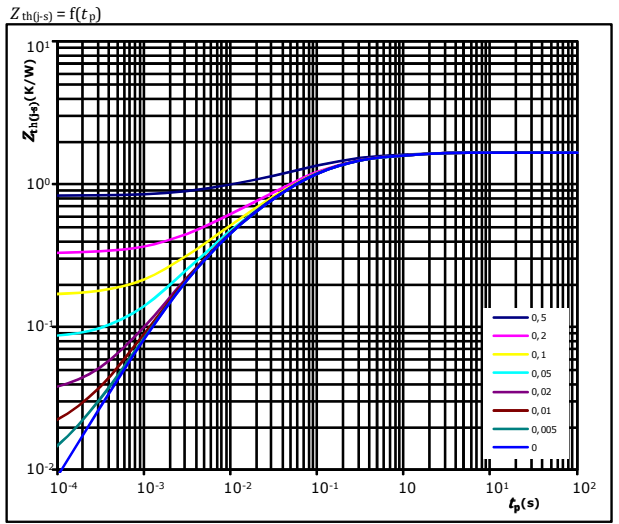

$D = t_p / T$
 $R_{th(j-s)} = 1,67 \text{ K/W}$
IGBT thermal model values

R_{th} (K/W)	τ (s)
1,80E-01	1,06E+00
3,72E-01	1,72E-01
6,39E-01	5,52E-02
3,20E-01	1,27E-02
1,54E-01	3,03E-03



Vincotech

Boost Switch Characteristics

Gate voltage vs Gate charge IGBT

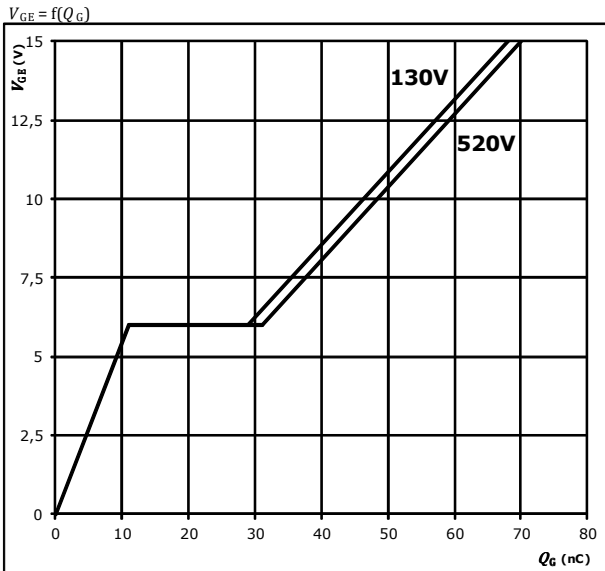

At
 $I_C = 30$ A

Boost Diode Characteristics

Typical forward characteristics FWD

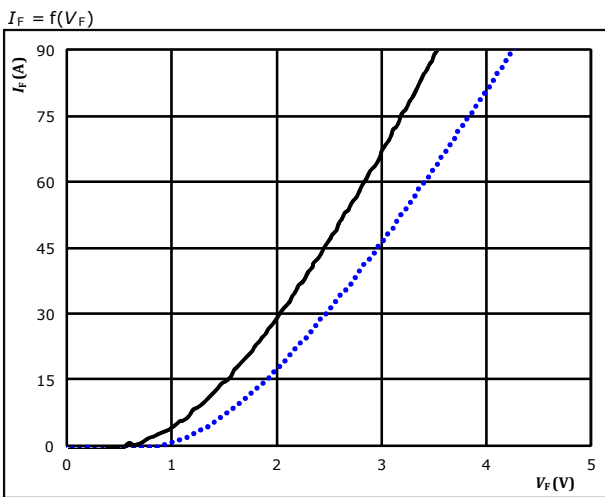

$t_p = 250$ μ s
 T_j : 25 °C (blue dotted), 125 °C (solid black), 150 °C (dashed red)

Transient thermal impedance as a function of pulse width FWD

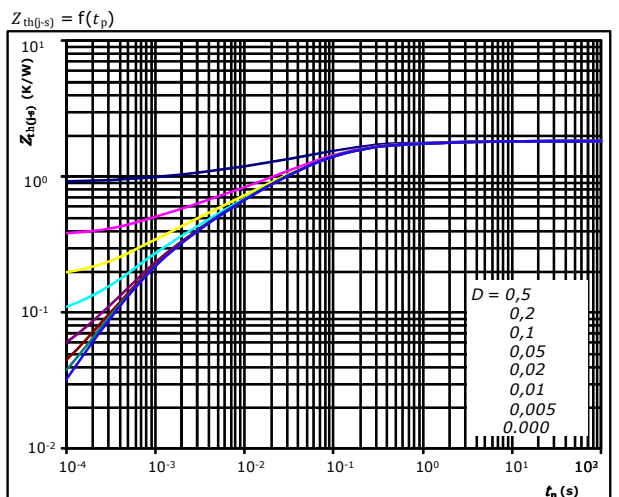

$D = t_p / T$
 $R_{th(j-s)} = 1,83$ K/W

FWD thermal model values

R (K/W)	τ (s)
6,05E-02	3,63E+00
1,50E-01	6,48E-01
8,27E-01	7,70E-02
4,06E-01	1,51E-02
2,16E-01	3,45E-03
1,73E-01	7,36E-04



Vincotech

Boost Inverse Diode Characteristics

Typical forward characteristics FWD

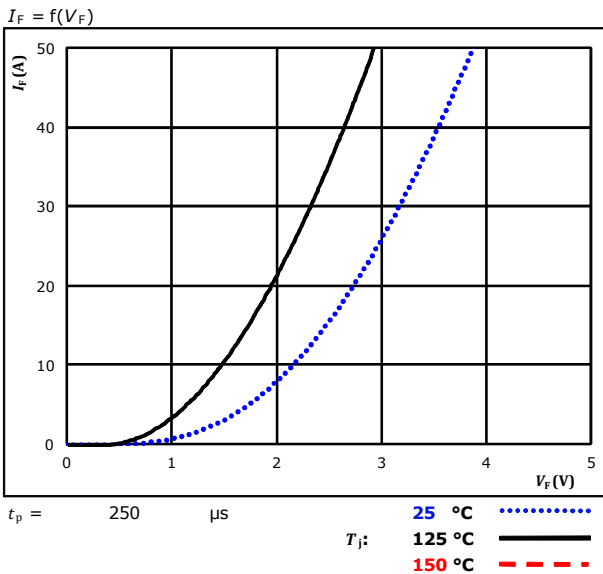

Transient thermal impedance as a function of pulse width FWD

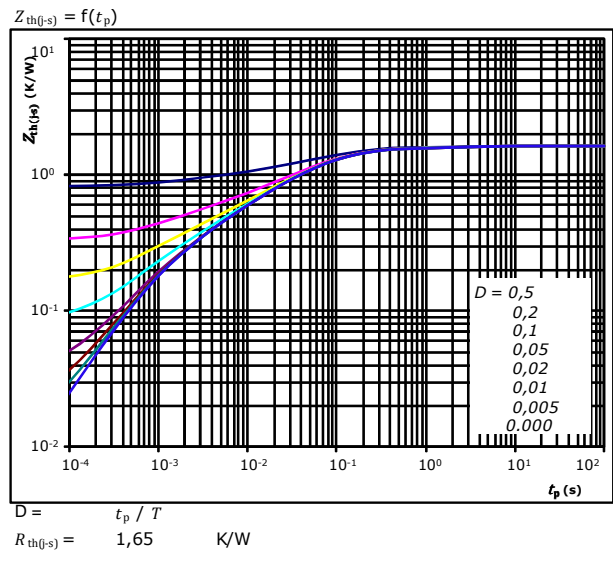

FWD thermal model values

R (K/W)	τ (s)
5,16E-02	4,05E+00
1,04E-01	5,69E-01
7,15E-01	7,94E-02
4,04E-01	1,99E-02
2,10E-01	4,66E-03
1,69E-01	9,24E-04

Thermistor Characteristics

Thermistor typical temperature characteristic

Typical NTC characteristic
as a function of temperature

$R_T = f(T)$

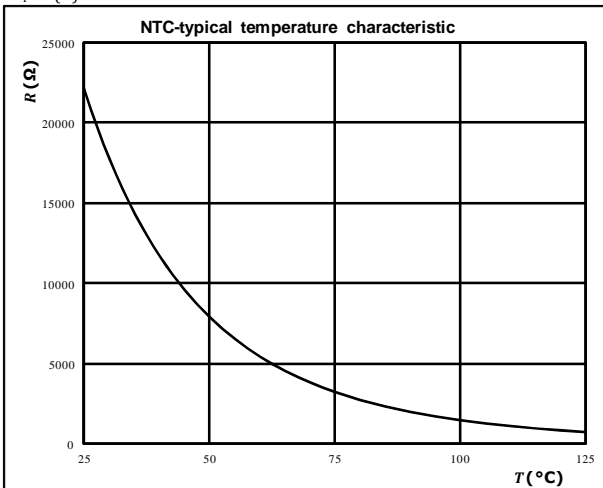



Boost Switching Characteristics

Figure 1. IGBT

Typical switching energy losses as a function of collector current

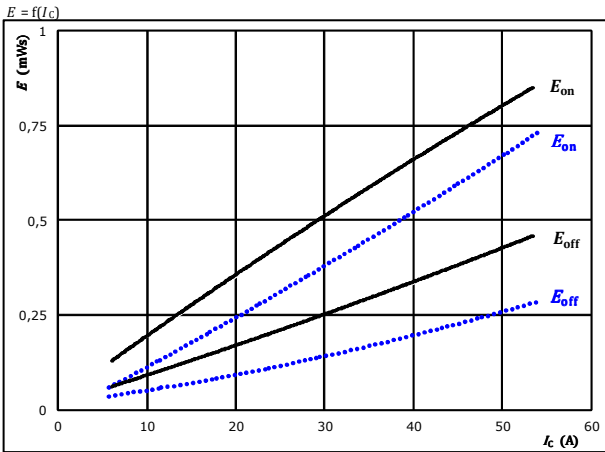

With an inductive load at
 $V_{CE} = 400$ V
 $V_{GE} = 15/0$ V
 $R_{gon} = 16$ Ω
 $R_{goff} = 16$ Ω
 T_j : 25 °C (dotted blue), 125 °C (solid black), 150 °C (dashed red)

Figure 2. IGBT

Typical switching energy losses as a function of gate resistor

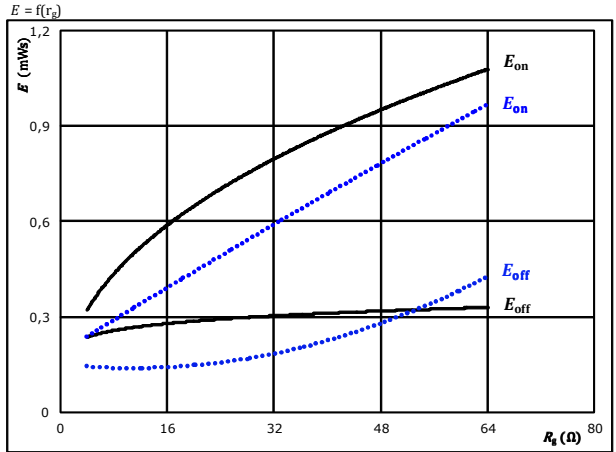

With an inductive load at
 $V_{CE} = 400$ V
 $V_{GE} = 15/0$ V
 $I_C = 30$ A
 T_j : 25 °C (dotted blue), 125 °C (solid black), 150 °C (dashed red)

Figure 3. FWD

Typical reverse recovered energy loss as a function of collector current

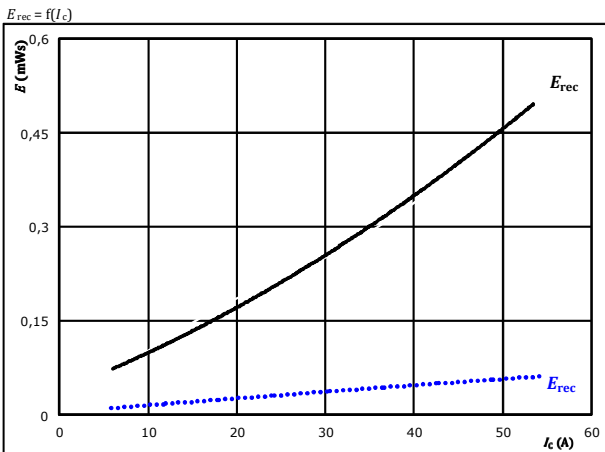

With an inductive load at
 $V_{CE} = 400$ V
 $V_{GE} = 15/0$ V
 $R_{gon} = 16$ Ω
 T_j : 25 °C (dotted blue), 125 °C (solid black), 150 °C (dashed red)

Figure 4. FWD

Typical reverse recovered energy loss as a function of gate resistor

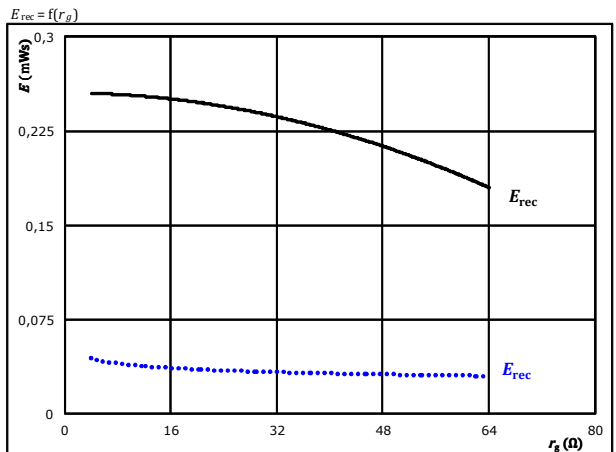

With an inductive load at
 $V_{CE} = 400$ V
 $V_{GE} = 15/0$ V
 $I_C = 30$ A
 T_j : 25 °C (dotted blue), 125 °C (solid black), 150 °C (dashed red)



Boost Switching Characteristics

Figure 5. IGBT
Typical switching times as a function of collector current

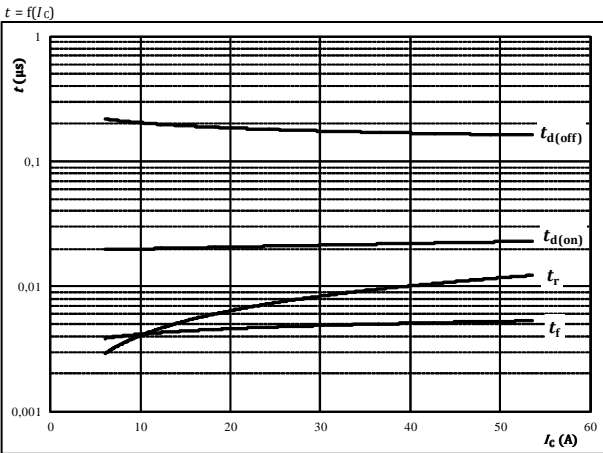

With an inductive load at

- $T_j = 125 \text{ } ^\circ\text{C}$
- $V_{CE} = 400 \text{ V}$
- $V_{GE} = 15/0 \text{ V}$
- $R_{gon} = 16 \text{ } \Omega$
- $R_{goff} = 16 \text{ } \Omega$

Figure 6. IGBT
Typical switching times as a function of gate resistor

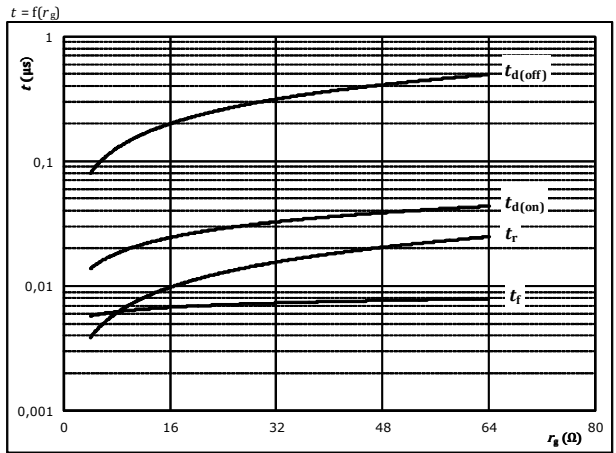

With an inductive load at

- $T_j = 125 \text{ } ^\circ\text{C}$
- $V_{CE} = 400 \text{ V}$
- $V_{GE} = 15/0 \text{ V}$
- $I_c = 30 \text{ A}$

Figure 7. FWD
Typical reverse recovery time as a function of collector current

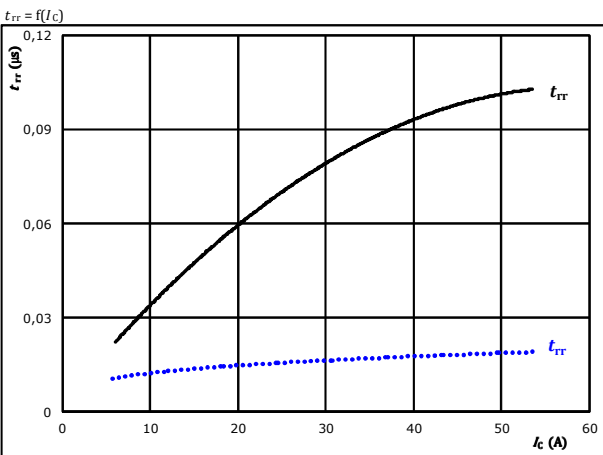

- At $V_{CE} = 400 \text{ V}$, $V_{GE} = 15/0 \text{ V}$, $R_{gon} = 16 \text{ } \Omega$
- T_j : $25 \text{ } ^\circ\text{C}$ (dotted blue line), $125 \text{ } ^\circ\text{C}$ (solid black line), $150 \text{ } ^\circ\text{C}$ (dashed red line)

Figure 8. FWD
Typical reverse recovery time as a function of IGBT turn on gate resistor

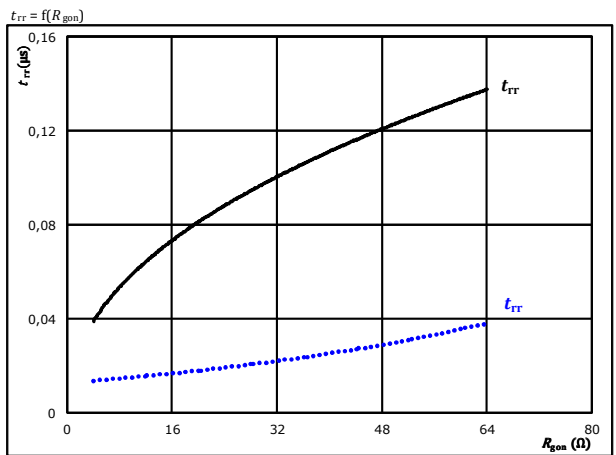

- At $V_{CE} = 400 \text{ V}$, $V_{GE} = 15/0 \text{ V}$, $I_c = 30 \text{ A}$
- T_j : $25 \text{ } ^\circ\text{C}$ (dotted blue line), $125 \text{ } ^\circ\text{C}$ (solid black line), $150 \text{ } ^\circ\text{C}$ (dashed red line)



Boost Switching Characteristics

Figure 9. FWD
Typical recovered charge as a function of collector current

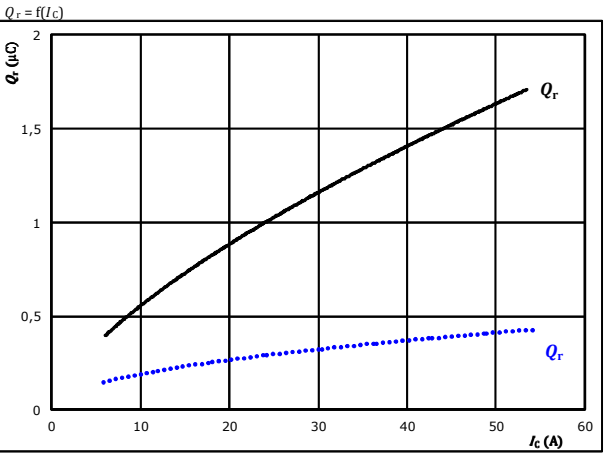

At $V_{CE} = 400$ V
 $V_{GE} = 15/0$ V
 $R_{gon} = 16$ Ω
 T_j : 25 °C (dotted blue line)
 125 °C (solid black line)
 150 °C (dashed red line)

Figure 10. FWD
Typical recovered charge as a function of IGBT turn on gate resistor

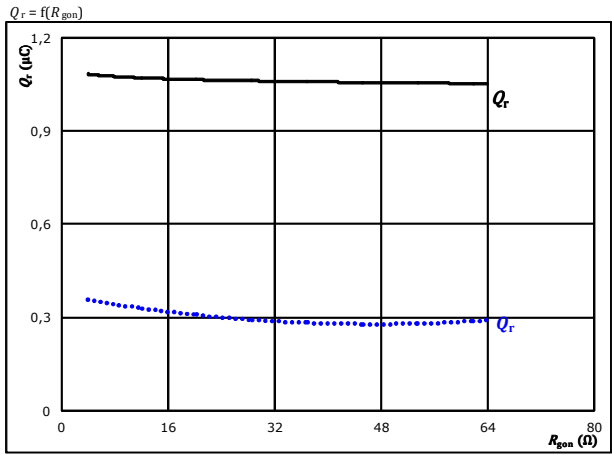

At $V_{CE} = 400$ V
 $V_{GE} = 15/0$ V
 $I_c = 30$ A
 T_j : 25 °C (dotted blue line)
 125 °C (solid black line)
 150 °C (dashed red line)

Figure 11. FWD
Typical peak reverse recovery current as a function of collector current

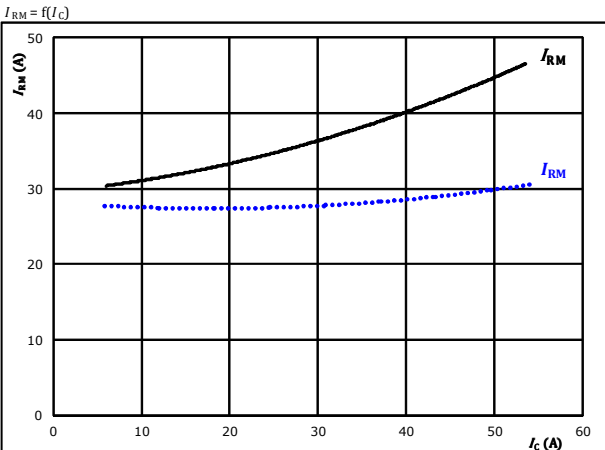

At $V_{CE} = 400$ V
 $V_{GE} = 15/0$ V
 $R_{gon} = 16$ Ω
 T_j : 25 °C (dotted blue line)
 125 °C (solid black line)
 150 °C (dashed red line)

Figure 12. FWD
Typical peak reverse recovery current as a function of IGBT turn on gate resistor

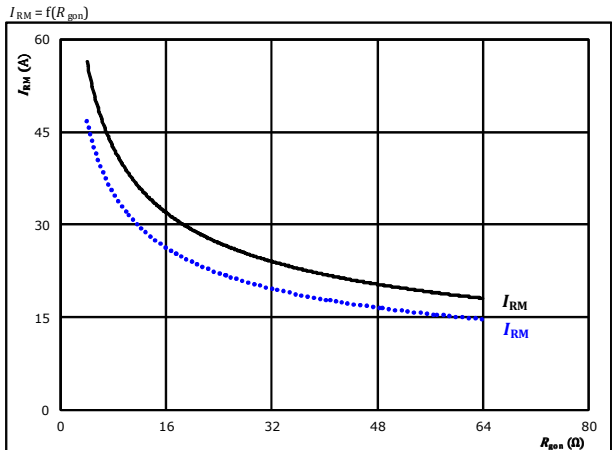

At $V_{CE} = 400$ V
 $V_{GE} = 15/0$ V
 $I_c = 30$ A
 T_j : 25 °C (dotted blue line)
 125 °C (solid black line)
 150 °C (dashed red line)



Vincotech

Boost Switching Characteristics

Figure 13. FWD

Typical rate of fall of forward and reverse recovery current as a function of collector current

$$di_F/dt, di_{rr}/dt = f(I_C)$$

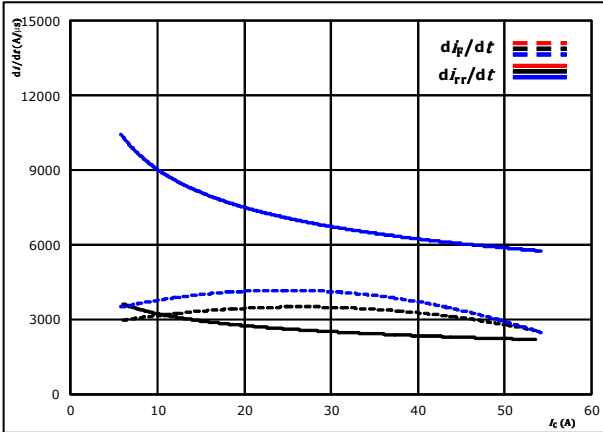

At $V_{CE} = 400$ V $T_j: 25$ °C
 $V_{GE} = 15/0$ V 125 °C ———
 $R_{gon} = 16$ Ω 150 °C - - - - -

Figure 14. FWD

Typical rate of fall of forward and reverse recovery current as a function of IGBT turn on gate resistor

$$di_F/dt, di_{rr}/dt = f(R_g)$$

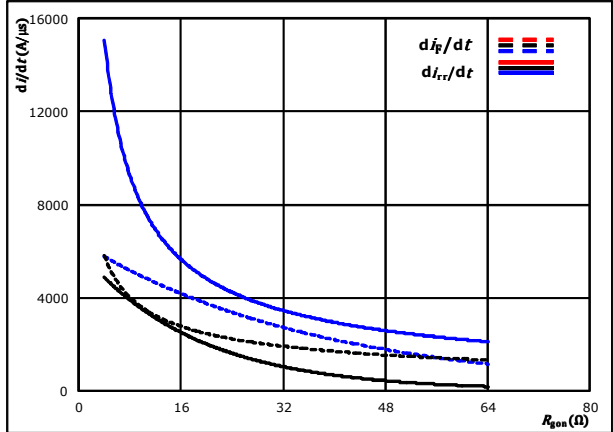

At $V_{CE} = 400$ V
 $V_{GE} = 15/0$ V
 $I_C = 30$ A

Figure 15. IGBT

Reverse bias safe operating area

$$I_C = f(V_{CE})$$

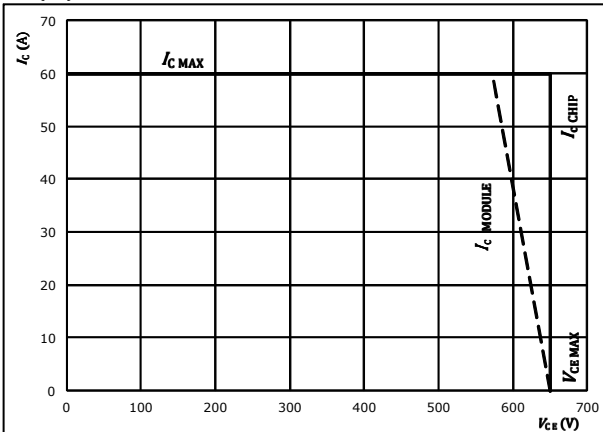

At $T_j = 175$ °C
 $R_{gon} = 16$ Ω
 $R_{goff} = 16$ Ω



Boost Switching Definitions

General conditions	
T_j	= 125 °C
R_{gon}	= 16 Ω
R_{goff}	= 16 Ω

Figure 1. IGBT
Turn-off Switching Waveforms & definition of t_{doff} , t_{Eoff} (t_{Eoff} = integrating time for Eoff)

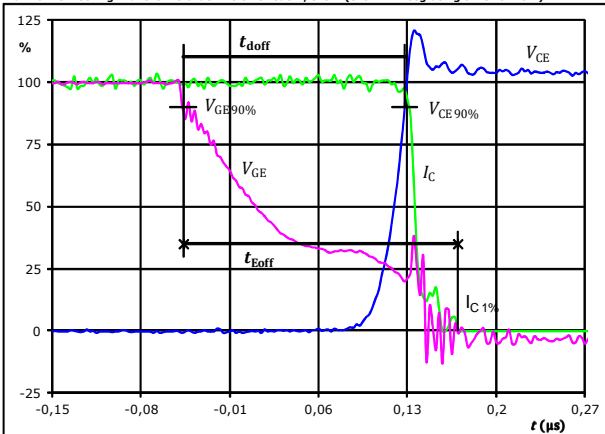

$V_{GE}(0\%) =$	0	V
$V_{GE}(100\%) =$	15	V
$V_C(100\%) =$	400	V
$I_C(100\%) =$	30	A
$t_{doff} =$	0,175	μs
$t_{Eoff} =$	0,216	μs

Figure 2. IGBT
Turn-on Switching Waveforms & definition of t_{don} , t_{Eon} (t_{Eon} = integrating time for Eon)

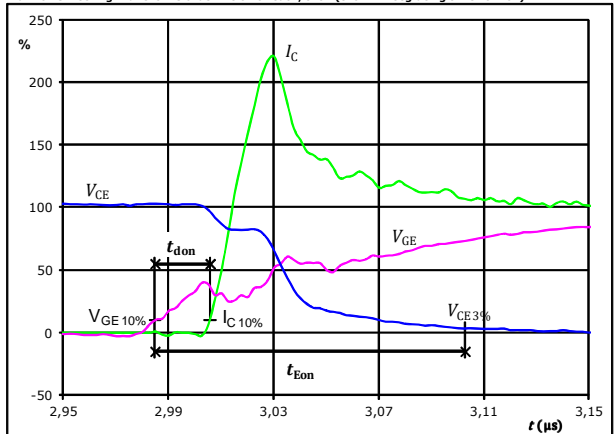

$V_{GE}(0\%) =$	0	V
$V_{GE}(100\%) =$	15	V
$V_C(100\%) =$	400	V
$I_C(100\%) =$	30	A
$t_{don} =$	0,021	μs
$t_{Eon} =$	0,118	μs

Figure 3. IGBT
Turn-off Switching Waveforms & definition of t_f

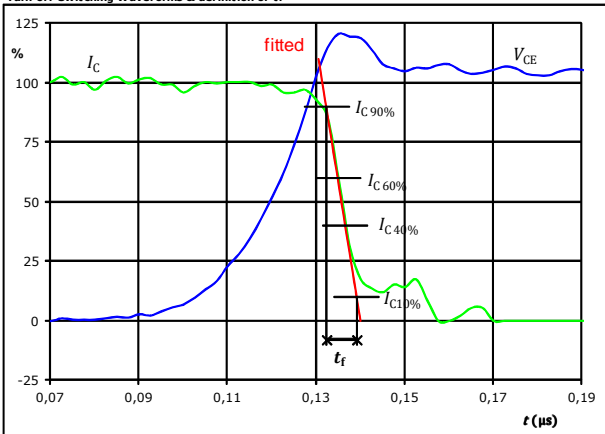

$V_C(100\%) =$	400	V
$I_C(100\%) =$	30	A
$t_f =$	0,005	μs

Figure 4. IGBT
Turn-on Switching Waveforms & definition of t_r

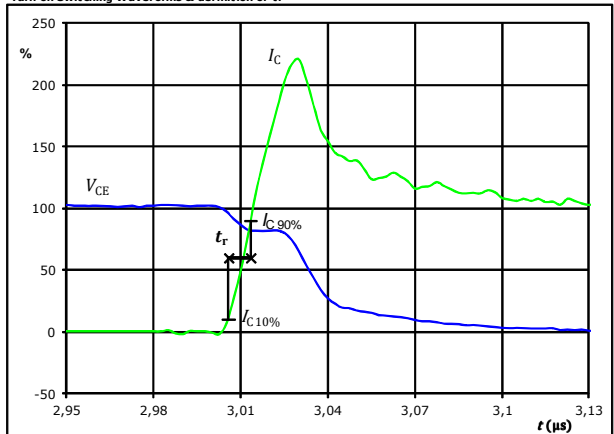

$V_C(100\%) =$	400	V
$I_C(100\%) =$	30	A
$t_r =$	0,008	μs



Vincotech

Boost Switching Definitions

Figure 5. IGBT

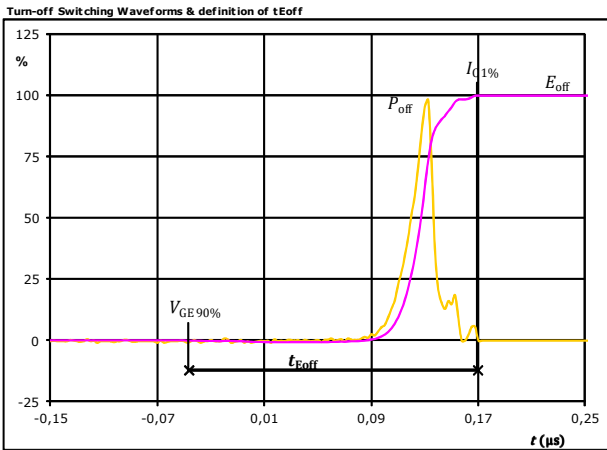

$P_{off}(100\%) =$	11,95	kW
$E_{off}(100\%) =$	0,25	mJ
$t_{Eoff} =$	0,216	μs

Figure 6. IGBT

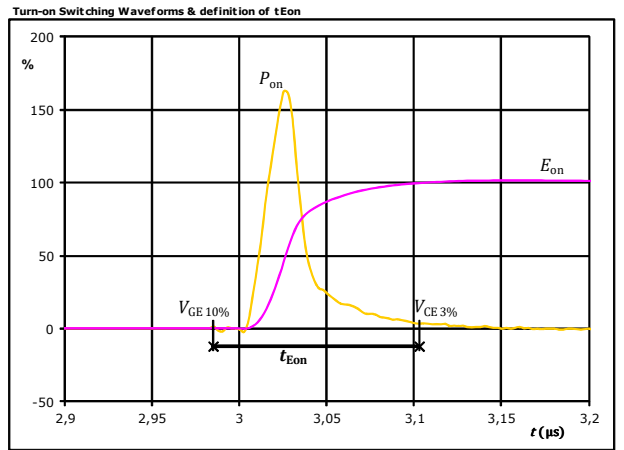

$P_{on}(100\%) =$	11,95	kW
$E_{on}(100\%) =$	0,51	mJ
$t_{Eon} =$	0,118	μs

Figure 7. FWD

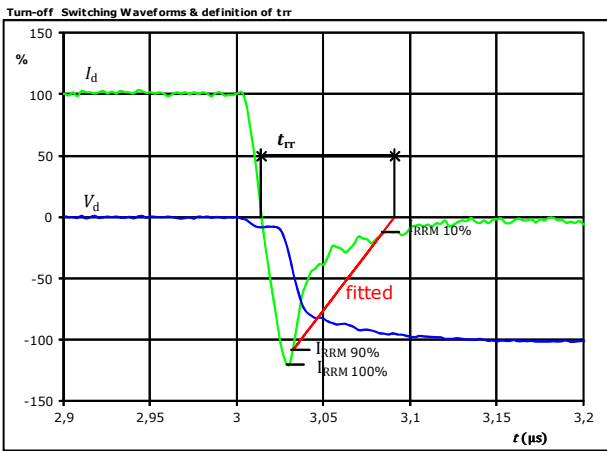

$V_d(100\%) =$	400	V
$I_d(100\%) =$	30	A
$I_{RRM}(100\%) =$	-36	A
$t_{tr} =$	0,077	μs



Boost Switching Definitions

Figure 8. FWD
Turn-on Switching Waveforms & definition of t_{Qrr} (t_{Qrr} = integrating time for Q_{rr})

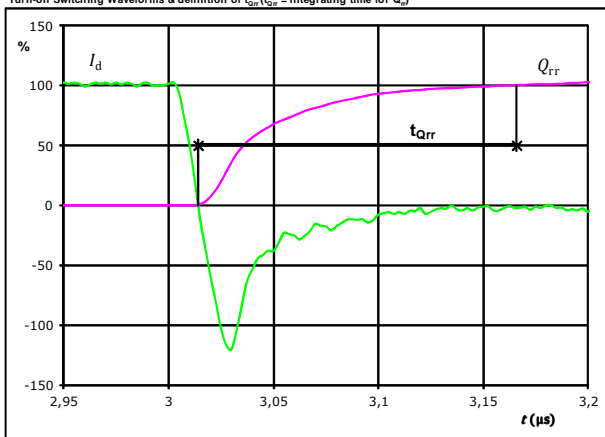

I_d (100%) =	30	A
Q_{rr} (100%) =	1,09	μC
t_{Qrr} =	0,152	μs

Figure 9. FWD
Turn-on Switching Waveforms & definition of t_{Erec} (t_{Erec} = integrating time for E_{rec})

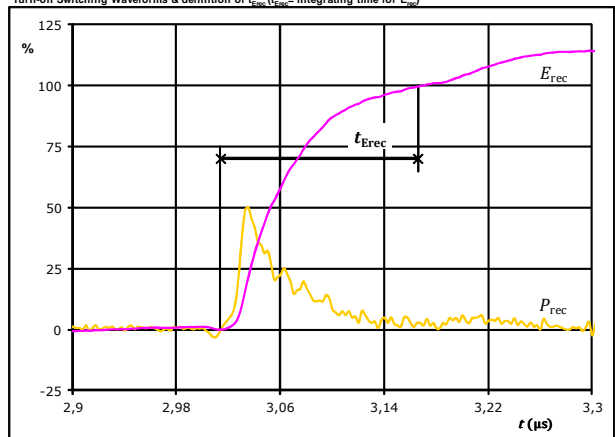

P_{rec} (100%) =	11,95	kW
E_{rec} (100%) =	0,25	mJ
t_{Erec} =	0,152	μs



Vincotech

Ordering Code & Marking							
Version	Ordering Code	in DataMatrix as	in packaging barcode as				
without thermal paste 12mm housing	10-FZ07B2A030SM02-M575L48	M575L48	M575L48				
NN-NNNNNNNNNNNNNNNN NNNNNNNN WWYY UL Vinco LLLLL SSSS		Text	Name	Date code	UL & Vinco	Lot	Serial
			NN-NNNNNNNNNNNNNNNN	WWYY	UL Vinco	LLLLL	SSSS
		Datamatrix	Type&Ver	Lot number	Serial	Date code	
			TTTTTTVV	LLLLL	SSSS	WWYY	

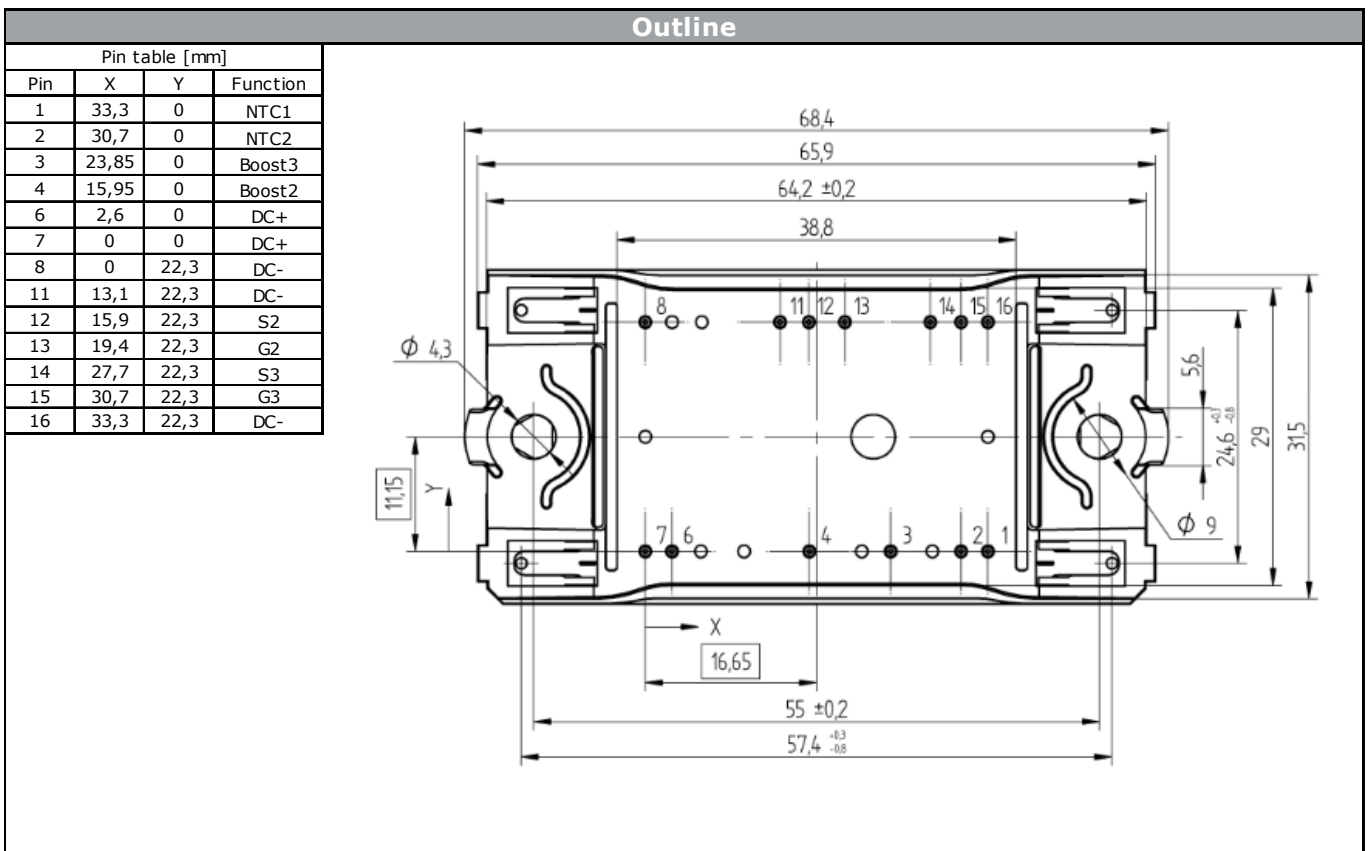



Vincotech

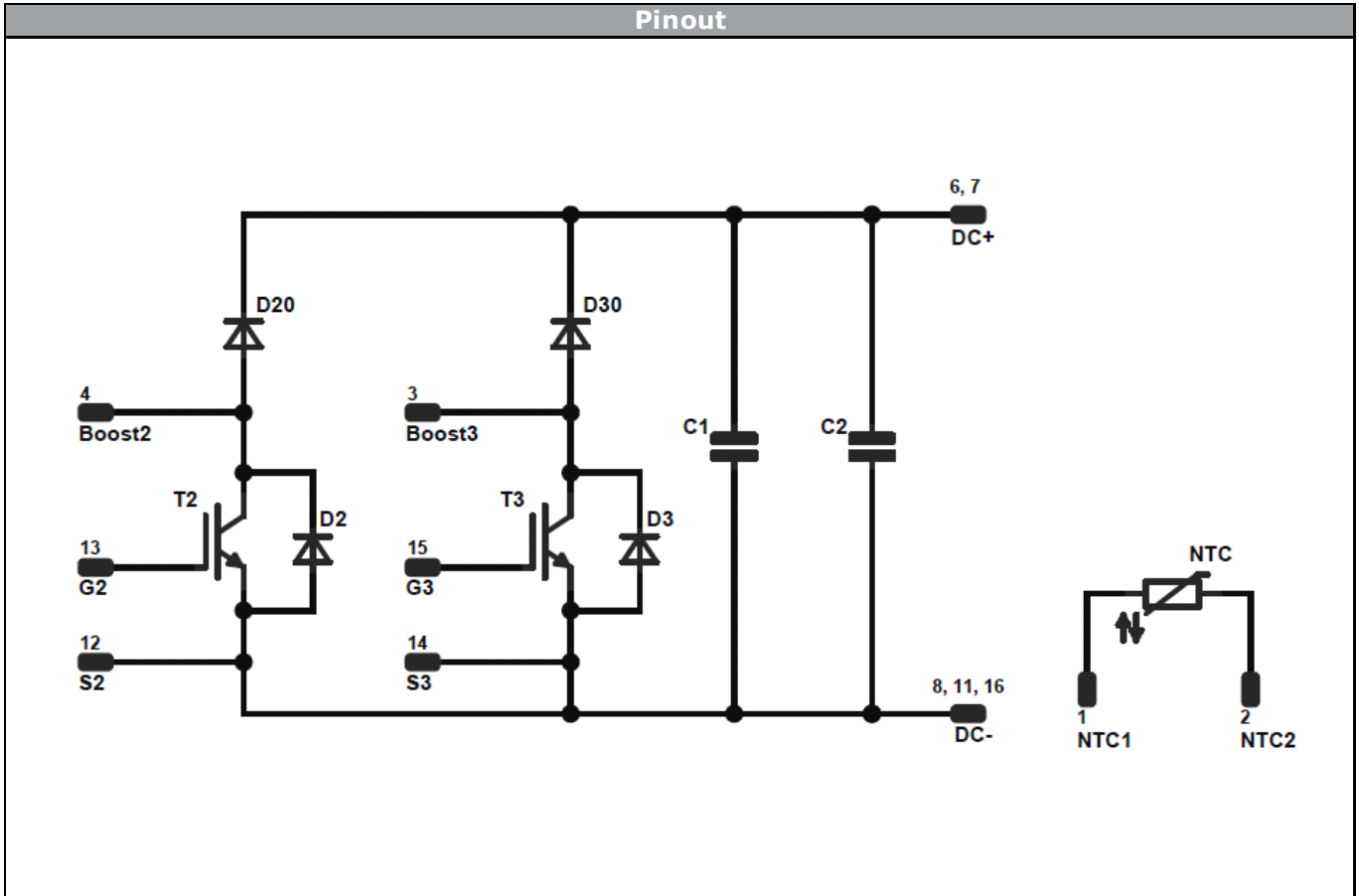

Identification					
ID	Component	Voltage	Current	Function	Comment
T2,T3	IGBT	650V	30A	Boost Switch	IGC10T65U8Q
D20,D30	FWD	650V	30A	Boost Diode	PCFF30S65W
D2,D3	FWD	650V	15A	Boost Inverse Diode	PCFF15S65W
C1,C2	Capacitor	1000V		DC Link Capacitor	
NTC	NTC			Thermistor	



Vincotech

Packaging instruction					
Standard packaging quantity (SPQ)	135	>SPQ	Standard	<SPQ	Sample

Handling instruction	
Handling instructions for <i>flow</i> 0 packages see vincotech.com website.	

Document No.:	Date:	Modification:	Pages
10-FZ07B2A030SM02-M575L48-D2-14	24 Jul. 2015	New topology name	1

DISCLAIMER

The information, specifications, procedures, methods and recommendations herein (together "information") are presented by Vincotech to reader in good faith, are believed to be accurate and reliable, but may well be incomplete and/or not applicable to all conditions or situations that may exist or occur. Vincotech reserves the right to make any changes without further notice to any products to improve reliability, function or design. No representation, guarantee or warranty is made to reader as to the accuracy, reliability or completeness of said information or that the application or use of any of the same will avoid hazards, accidents, losses, damages or injury of any kind to persons or property or that the same will not infringe third parties rights or give desired results. It is reader's sole responsibility to test and determine the suitability of the information and the product for reader's intended use.

LIFE SUPPORT POLICY

Vincotech products are not authorised for use as critical components in life support devices or systems without the express written approval of Vincotech.

As used herein:

1. Life support devices or systems are devices or systems which, (a) are intended for surgical implant into the body, or (b) support or sustain life, or (c) whose failure to perform when properly used in accordance with instructions for use provided in labelling can be reasonably expected to result in significant injury to the user.
2. A critical component is any component of a life support device or system whose failure to perform can be reasonably expected to cause the failure of the life support device or system, or to affect its safety or effectiveness.