

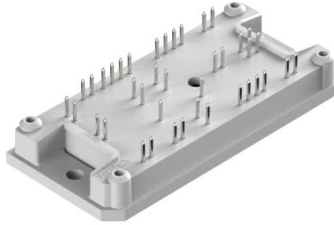
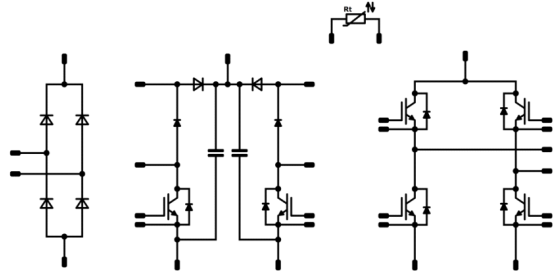
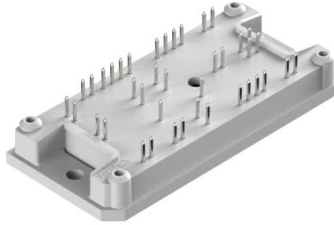
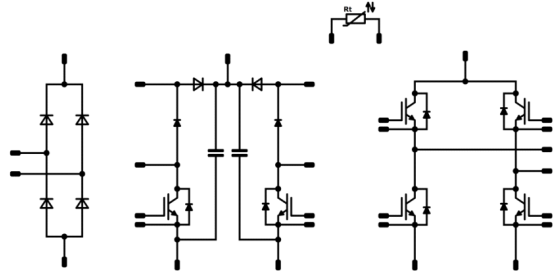
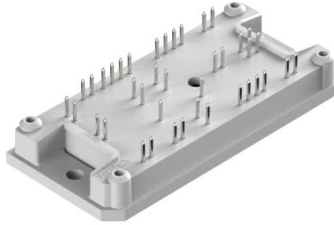
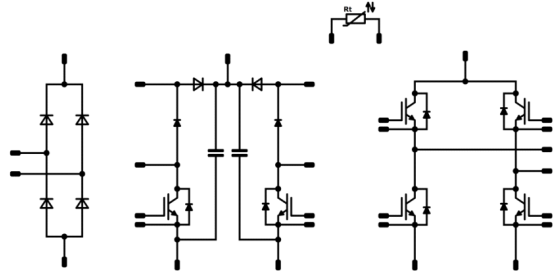

Vincotech

flowRPI 1	650 V / 50 A										
<table border="1" style="width:100%; border-collapse: collapse;"> <tr> <th style="background-color: #cccccc;">Features</th> </tr> <tr> <td> <ul style="list-style-type: none"> High integration level of Rectifier, PFC and Inverter High efficiency input rectifier Wide input voltage range rated PFC Dual PFC with high efficiency, fast IGBT H5 + ultra-fast Si diode High efficiency H-Bridge inverter with fast IGBT H5 Temperature sensor </td> </tr> </table> <table border="1" style="width:100%; border-collapse: collapse;"> <tr> <th style="background-color: #cccccc;">Target applications</th> </tr> <tr> <td> <ul style="list-style-type: none"> Welding Charger </td> </tr> </table> <table border="1" style="width:100%; border-collapse: collapse;"> <tr> <th style="background-color: #cccccc;">Types</th> </tr> <tr> <td> <ul style="list-style-type: none"> 10-FY07ZAB050SM-L514B08-/3/ </td> </tr> </table>	Features	<ul style="list-style-type: none"> High integration level of Rectifier, PFC and Inverter High efficiency input rectifier Wide input voltage range rated PFC Dual PFC with high efficiency, fast IGBT H5 + ultra-fast Si diode High efficiency H-Bridge inverter with fast IGBT H5 Temperature sensor 	Target applications	<ul style="list-style-type: none"> Welding Charger 	Types	<ul style="list-style-type: none"> 10-FY07ZAB050SM-L514B08-/3/ 	<table border="1" style="width:100%; border-collapse: collapse;"> <tr> <th style="background-color: #cccccc;">flow 1 12mm housing</th> </tr> <tr> <td style="text-align: center;">  </td> </tr> </table> <table border="1" style="width:100%; border-collapse: collapse;"> <tr> <th style="background-color: #cccccc;">Schematic</th> </tr> <tr> <td style="text-align: center;">  </td> </tr> </table>	flow 1 12mm housing		Schematic	
Features											
<ul style="list-style-type: none"> High integration level of Rectifier, PFC and Inverter High efficiency input rectifier Wide input voltage range rated PFC Dual PFC with high efficiency, fast IGBT H5 + ultra-fast Si diode High efficiency H-Bridge inverter with fast IGBT H5 Temperature sensor 											
Target applications											
<ul style="list-style-type: none"> Welding Charger 											
Types											
<ul style="list-style-type: none"> 10-FY07ZAB050SM-L514B08-/3/ 											
flow 1 12mm housing											
											
Schematic											
											

Maximum Ratings

$T_j=25^{\circ}\text{C}$, unless otherwise specified

Parameter	Symbol	Conditions	Value	Unit
Rectifier Diode				
Peak Repetitive Reverse Voltage	V_{RRM}		1600	V
Continuous (direct) forward current	I_F	$T_j = T_{jmax}$ $T_S = 80^{\circ}\text{C}$	50	A
Surge (non-repetitive) forward current	I_{FSM}	50 Hz Single Half Sine Wave $T_j = 150^{\circ}\text{C}$	490	A
Surge current capability	I^2t	$t_p = 10\text{ ms}$ 50 Hz sine	1200	A^2s
Total power dissipation	P_{tot}	$T_j = T_{jmax}$ $T_S = 80^{\circ}\text{C}$	86	W
Maximum Junction Temperature	T_{jmax}		150	$^{\circ}\text{C}$



Vincotech

Parameter	Symbol	Condition	Value	Unit
PFC Switch				
Collector-emitter voltage	V_{CES}		650	V
Collector current	I_C	$T_j = T_{jmax}$ $T_S = 80\text{ °C}$	50	A
Repetitive peak collector current	I_{CRM}	t_p limited by T_{jmax}	225	A
Total power dissipation	P_{tot}	$T_j = T_{jmax}$ $T_S = 80\text{ °C}$	84	W
Gate-emitter voltage	V_{GES}		±20	V
Maximum Junction Temperature	T_{jmax}		175	°C

Parameter	Symbol	Conditions	Value	Unit
PFC Diode				
Peak Repetitive Reverse Voltage	V_{RRM}		650	V
Continuous (direct) forward current	I_F	$T_j = T_{jmax}$ $T_S = 80\text{ °C}$	29	A
Repetitive peak forward current	I_{FRM}		90	A
Power dissipation	P_{tot}	$T_j = T_{jmax}$ $T_S = 80\text{ °C}$	52	W
Maximum Junction Temperature	T_{jmax}		175	°C

Parameter	Symbol	Conditions	Value	Unit
C. T. Protection Diode				
Peak Repetitive Reverse Voltage	V_{RRM}		650	V
DC forward current	I_F	$T_j = T_{jmax}$ $T_S = 80\text{ °C}$	17	A
Repetitive peak forward current	I_{FRM}		20	A
Power dissipation	P_{tot}	$T_j = T_{jmax}$ $T_S = 80\text{ °C}$	33	W
Maximum Junction Temperature	T_{jmax}		175	°C



Vincotech

Parameter	Symbol	Condition	Value	Unit
H-Bridge Switch Lo/Hi Side				
Collector-emitter voltage	V_{CES}		650	V
Collector current	I_C	$T_j = T_{jmax}$ $T_S = 80\text{ °C}$	43	A
Repetitive peak collector current	I_{CRM}	t_p limited by T_{jmax}	150	A
Total power dissipation	P_{tot}	$T_j = T_{jmax}$ $T_S = 80\text{ °C}$	84	W
Gate-emitter voltage	V_{GES}		±20	V
Maximum Junction Temperature	T_{jmax}		175	°C

Parameter	Symbol	Conditions	Value	Unit
H-Bridge Diode Lo/Hi Side				
Peak Repetitive Reverse Voltage	V_{RRM}		650	V
DC forward current	I_F	$T_j = T_{jmax}$ $T_S = 80\text{ °C}$	40	A
Repetitive peak forward current	I_{FRM}		100	A
Power dissipation	P_{tot}	$T_j = T_{jmax}$ $T_S = 80\text{ °C}$	64	W
Maximum Junction Temperature	T_{jmax}		175	°C

Parameter	Symbol	Conditions	Value	Unit
DC Capacitor				
Maximum DC voltage	V_{MAX}		630	V
Operation Temperature	T_{op}		-55...+125	°C



Vincotech

Parameter	Symbol	Conditions	Value	Unit	
Module Properties					
Thermal Properties					
Storage temperature	T_{stg}		-40...+125	°C	
Operation Junction Temperature	T_{jop}		-40...+(T_{jmax} - 25)	°C	
Isolation Properties					
Isolation voltage	V_{isol}	DC voltage	$t_p=2s$	4000	V
Creepage distance				min 12,7	mm
Clearance				7,74	mm
Comparative Tracking Index	CTI			>200	



Vincotech

Characteristic Values

Rectifier Diode

Parameter	Symbol	Conditions					Value			Unit
				V_r [V]	I_F [A]	T_j [°C]	Min	Typ	Max	
Static										
Forward voltage	V_F				25	25 125 150		1,07 1,13	1,21	V
Reverse leakage current	I_r			1600		25 145			50 1100	μA
Thermal										
Thermal resistance junction to sink	$R_{th(j-s)}$	phase-change material $\lambda=3,4W/mK$						0,82		K/W

PFC Switch

Parameter	Symbol	Conditions					Value			Unit
			V_{GE} [V]	V_{CE} [V]	I_C [A]	T_j [°C]	Min	Typ	Max	
Static										
Gate-emitter threshold voltage	$V_{GE(th)}$	$V_{GE}=V_{CE}$			0,00075	25 125	3,3	4	4,7	V
Collector-emitter saturation voltage	V_{CEsat}		15		75	25 125 150		1,67 1,84 1,89	2,22	V
Collector-emitter cut-off current	I_{CES}		0	650		25 125			40	μA
Gate-emitter leakage current	I_{GES}		20	0		25 125			120	nA
Internal gate resistance	r_g							none		Ω
Input capacitance	C_{ies}							4300		pF
Output capacitance	C_{oes}	f=1 MHz	0	25		25		75		
Reverse transfer capacitance	C_{res}							16		
Gate charge	Q_g		15	520	75	25		166		nC
Thermal										
Thermal resistance junction to sink	$R_{th(j-s)}$	phase-change material $\lambda=3,4W/mK$						1,14		K/W



Vincotech

PFC Diode

Parameter	Symbol	Conditions					Value			Unit
		V_r [V]	I_F [A]	T_j [°C]	Min	Typ	Max			

Static

Forward voltage	V_F				30	25 125 150		2,46 2,03	2,6	V
Reverse leakage current	I_r			665		25 150			10	μ A

Thermal

Thermal resistance junction to sink	$R_{th(j-s)}$	phase-change material $\lambda=3,4W/mK$						1,83		K/W
-------------------------------------	---------------	--	--	--	--	--	--	------	--	-----

C. T. Protection Diode

Parameter	Symbol	Conditions					Value			Unit
		V_r [V]	I_F [A]	T_j [°C]	Min	Typ	Max			

Static

Forward voltage	V_F				10	25 125 150		1,67 1,56	1,87	V
Reverse leakage current	I_{rm}			650		25 150			0,14	μ A

Thermal

Thermal resistance junction to sink	$R_{th(j-s)}$	phase-change material $\lambda=3,4W/mK$						2,87		K/W
-------------------------------------	---------------	--	--	--	--	--	--	------	--	-----



Vincotech

H-Bridge Switch Lo/Hi Side

Parameter	Symbol	Conditions					Value			Unit
		V_{GE} [V]	V_{CE} [V]	I_C [A]	T_j [°C]	Min	Typ	Max		

Static

Gate-emitter threshold voltage	$V_{GE(th)}$	$V_{GE}=V_{CE}$			0,0005	25 125	3,3	4	4,7	V
Collector-emitter saturation voltage	V_{CEsat}		15		50	25 125 150	1	1,82 2,00	2,22	V
Collector-emitter cut-off current	I_{CES}		0	650		25 125			40	μA
Gate-emitter leakage current	I_{GES}		20	0		25 125			120	nA
Internal gate resistance	r_g							none		Ω
Input capacitance	C_{ies}							3000		pF
Output capacitance	C_{oes}	f=1 MHz	0	25		25		50		
Reverse transfer capacitance	C_{res}							11		
Gate charge	Q_g		15	520	50	25		120		nC

Thermal

Thermal resistance junction to sink	$R_{th(j-s)}$	phase-change material $\lambda=3,4W/mK$						1,13		K/W
-------------------------------------	---------------	--	--	--	--	--	--	------	--	-----

H-Bridge Diode Lo/Hi Side

Parameter	Symbol	Conditions					Value			Unit
		di_f/dt [A/us]	V_r [V]	I_F [A]	T_j	Min	Typ	Max		

Static

Forward voltage	V_F			50		25°C 125°C 150°C		1,55 1,50 1,45	1,82	V
Reverse leakage current	I_{rm}			650		25°C 150°C			0,6	μA

Thermal

Thermal resistance chip to heatsink	$R_{th(jH)}$	Phase-Change Material $\lambda=3,4W/mK$						1,48		K/W
-------------------------------------	--------------	--	--	--	--	--	--	------	--	-----



Vincotech

DC Capacitor

Parameter	Symbol	Conditions					Value			Unit
						T_j [°C]	Min	Typ	Max	
Capacitance	C							100		nF
Tolerance							-10		+10	%

Thermistor

Parameter	Symbol	Conditions					Value			Unit
			V_{GE} [V]	V_{CE} [V]	I_C [A]	T_{jt} [°C]	Min	Typ	Max	
Rated resistance	R					25		21,5		kΩ
Deviation of R100	$\Delta_{R/R}$	R100=1486 Ω				100	-4,5		+4,5	%
Power dissipation	P					25		210		mW
Power dissipation constant						25		3,5		mW/K
B-value	$B_{(25/50)}$					25		3884		K
B-value	$B_{(25/100)}$					25		3964		K
Vincotech NTC Reference									F	



10-FY07ZAB050SM-L514B08

target datasheet

Vincotech

Ordering Code & Marking							
Version	Ordering Code	in DataMatrix as	in packaging barcode as				
without thermal paste 12mm housing	10-FY07ZAB050SM-L514B08-/3/	L514B08	L514B08-/3/				
NN-NNNNNNNNNNNNNN NNNNNNNN WWYY UL Vinco LLLLL SSSS		Text	Name	Date code	UL & Vinco	Lot	Serial
			NN-NNNNNNNNNNNNNN-NNNNNNNN	WWYY	UL Vinco	LLLLL	SSSS
		Datamatrix	Type&Ver	Lot number	Serial	Date code	
		TTTTTTVV	LLLLL	SSSS	WWYY		

Outline							
Pin table [mm]				Pin table [mm]			
Pin	X	Y	Function	Pin	X	Y	Function
1	52,9	0	G13	30	49,8	12,9	DC-Inv2
2	49,9	0	S13	31	52,9	12,9	DC-Inv2
3	41,9	0	Ph2	32	52,9	15,9	DC-Inv1
4	39,2	0	Ph2	33	41,8	14,4	DC+Inv
5	36,2	0	S14	34	39,1	14,4	DC+Inv
6	33,2	0	G14	35	29,2	9,2	PFC2-
7	22	0	PFC+	36	15	9,2	PFC1-
8	22	3,5	PFC+	37	25	17,4	PFC2in2
9	13,4	0	DC+Rect	38	16,5	17	PFC1in2
10	10,7	0	DC+Rect	39	25	20,9	PFC2in1
11	2,7	0	DC-Rect	40	17	20,5	PFC1in1
12	0	0	DC-Rect				
13	0	13	ACIn1				
14	0	15,7	ACIn1				
15	0	23,7	ACIn2				
16	0	26,4	ACIn2				
17	7,7	28,8	Therm1				
18	10,7	28,8	Therm2				
19	14,6	28,8	S25				
20	17,6	28,8	G25				
21	20,6	28,8	G27				
22	23,6	28,8	S27				
23	33,2	28,8	G12				
24	36,2	28,8	S12				
25	39,2	28,8	Ph1				
26	41,9	28,8	Ph1				
27	49,9	28,8	S11				
28	52,9	28,8	G11				
29	49,8	15,9	DC-Inv1				

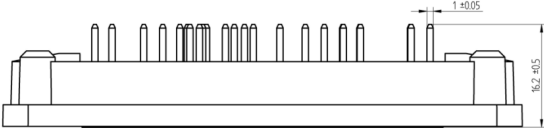
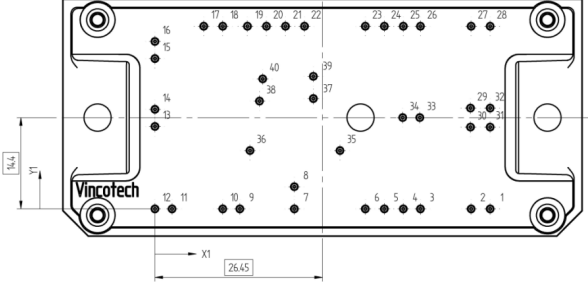



Tolerance of positions: ±0.5mm at the end of pins
Dimension of coordinate axis is only offset without tolerance

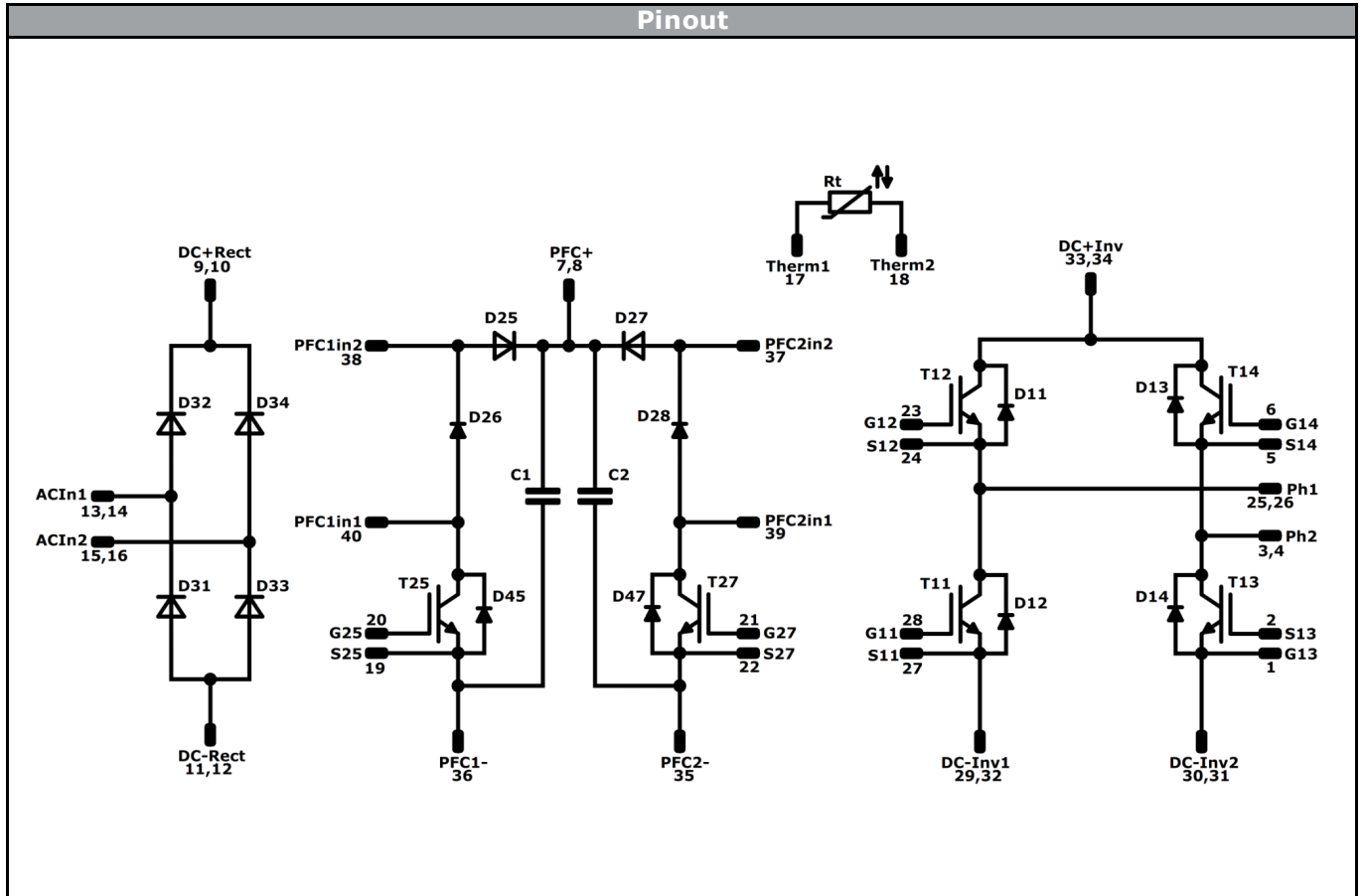

Vincotech

Pinout



Identification

ID	Component	Voltage	Current	Function	Comment
T25,T27	IGBT	650V	75A	PFC Switch	
D25,D27	FWD	650V	30A	PFC Diode	
D26, D28	FWD	650V	10A	C.T. Protection Diode	
T11, T13 / T12, T14	IGBT	650V	50A	H-Bridge Switch Lo/Hi Side	
D12, D14 / D11, D13	FWD	650V	50A	H-Bridge Diode Lo/Hi Side	
D31, D32, D33, D34	Rectifier	1600V	50A	Rectifier Diode	
C1,C2	Capacitor	630V	-	DC Capacitor	
NTC	NTC	-	-	Thermistor	



Vincotech

Packaging instruction			
Standard packaging quantity (SPQ)	100	>SPQ	Standard
		<SPQ	Sample

Handling instruction
Handling instructions for <i>flow</i> 1 packages see vincotech.com website.

Package data
Package data for <i>flow</i> 1 packages see vincotech.com website.

Document No.:	Date:	Modification:	Pages
10-FY07ZAB050SM-L514B08-T1-14	14 Aug. 2015		

Product status definition		
Datasheet Status	Product Status	Definition
Target	Formative or In Design	This datasheet contains the design specifications for product development. Specifications may change in any manner without notice. The data contained is exclusively intended for technically trained staff.

DISCLAIMER

The information, specifications, procedures, methods and recommendations herein (together "information") are presented by Vincotech to reader in good faith, are believed to be accurate and reliable, but may well be incomplete and/or not applicable to all conditions or situations that may exist or occur. Vincotech reserves the right to make any changes without further notice to any products to improve reliability, function or design. No representation, guarantee or warranty is made to reader as to the accuracy, reliability or completeness of said information or that the application or use of any of the same will avoid hazards, accidents, losses, damages or injury of any kind to persons or property or that the same will not infringe third parties rights or give desired results. It is reader's sole responsibility to test and determine the suitability of the information and the product for reader's intended use.

LIFE SUPPORT POLICY

Vincotech products are not authorised for use as critical components in life support devices or systems without the express written approval of Vincotech.

As used herein:

1. Life support devices or systems are devices or systems which, (a) are intended for surgical implant into the body, or (b) support or sustain life, or (c) whose failure to perform when properly used in accordance with instructions for use provided in labelling can be reasonably expected to result in significant injury to the user.
2. A critical component is any component of a life support device or system whose failure to perform can be reasonably expected to cause the failure of the life support device or system, or to affect its safety or effectiveness.