

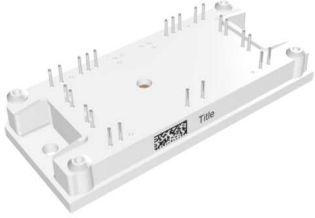
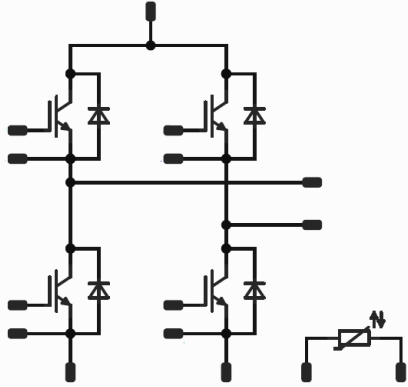

Vincotech

<i>flow</i> PACK 1	650 V / 50 A
<div style="border: 1px solid black; padding: 5px; margin-bottom: 5px;"> <p style="text-align: center; background-color: #cccccc; margin: 0;"><b>Features</b></p> <ul style="list-style-type: none"> <li>650V IGBT H5 and 650V Stealth Si diode</li> <li>High-efficiency</li> <li>Ultra-fast switching frequency</li> <li>Integrated temperature sensor</li> <li>Low inductance layout</li> </ul> </div> <div style="border: 1px solid black; padding: 5px; margin-bottom: 5px;"> <p style="text-align: center; background-color: #cccccc; margin: 0;"><b>Target applications</b></p> <ul style="list-style-type: none"> <li>Solar Inverters</li> <li>Power Supply</li> <li>Inverter based welding</li> </ul> </div> <div style="border: 1px solid black; padding: 5px;"> <p style="text-align: center; background-color: #cccccc; margin: 0;"><b>Types</b></p> <ul style="list-style-type: none"> <li>10-FY074PA050SM-M582F38</li> </ul> </div>	<div style="border: 1px solid black; padding: 5px; margin-bottom: 5px;"> <p style="text-align: center; background-color: #cccccc; margin: 0;"><i>flow</i> 1 12mm housing</p>  </div> <div style="border: 1px solid black; padding: 5px;"> <p style="text-align: center; background-color: #cccccc; margin: 0;"><b>Schematic</b></p>  </div>

## Maximum Ratings

$T_j=25^{\circ}\text{C}$ , unless otherwise specified

Parameter	Symbol	Condition	Value	Unit
<b>H-bridge Switch</b>				
Collector-emitter voltage	$V_{CES}$		650	V
Collector current	$I_C$	$T_j=T_{jmax}$ $T_S=80^{\circ}\text{C}$	43	A
Repetitive peak collector current	$I_{CRM}$	$t_p$ limited by $T_{jmax}$	150	A
Total power dissipation	$P_{tot}$	$T_j=T_{jmax}$ $T_S=80^{\circ}\text{C}$	84	W
Gate-emitter voltage	$V_{GES}$		$\pm 20$	V
Maximum Junction Temperature	$T_{jmax}$		175	$^{\circ}\text{C}$



Vincotech

Parameter	Symbol	Conditions	Value	Unit
<b>H-bridge Diode</b>				
Peak Repetitive Reverse Voltage	$V_{RRM}$		650	V
Continuous (direct) forward current	$I_F$	$T_j=T_{jmax}$ $T_h=80^{\circ}C$	29	A
Repetitive peak forward current	$I_{FRM}$		180	A
Total power dissipation	$P_{tot}$	$T_j=T_{jmax}$ $T_h=80^{\circ}C$	52	W
Maximum Junction Temperature	$T_{jmax}$		175	$^{\circ}C$

### Module Properties

Parameter	Symbol	Conditions	Value	Unit
<b>Thermal Properties</b>				
Storage temperature	$T_{stg}$		-40...+125	$^{\circ}C$
Operation Junction Temperature	$T_{jop}$		-40...+( $T_{jmax} - 25$ )	$^{\circ}C$

### Isolation Properties

Isolation voltage	$V_{isol}$	DC voltage	$t_p=2s$	4000	V
Creepage distance				min 12,7	mm
Clearance				8,47	mm
Comparative Tracking Index	CTI			>200	



Vincotech

## Characteristic Values

### H-bridge Switch

Parameter	Symbol	Conditions					Value			Unit
		$V_{GE}$ [V]	$V_{CE}$ [V]	$I_C$ [A]	$T_j$ [°C]	Min	Typ	Max		

#### Static

Gate-emitter threshold voltage	$V_{GE(th)}$	$V_{GE}=V_{CE}$			0,0005	25 125	3,3	4	4,7	V
Collector-emitter saturation voltage	$V_{CEsat}$		15		50	25 125 150	1	1,82 2,00 -	2,22	V
Collector-emitter cut-off current	$I_{CES}$		0	650		25 125			40	μA
Gate-emitter leakage current	$I_{GES}$		20	0		25 125			120	nA
Internal gate resistance	$r_g$							none		Ω
Input capacitance	$C_{ies}$	f=1 MHz	0	25	25	25		3000		pF
Output capacitance	$C_{oes}$							50		
Reverse transfer capacitance	$C_{res}$							11		
Gate charge	$Q_g$		15	520	50	25		120		nC

#### Thermal

Thermal resistance junction to sink	$R_{th(j-s)}$	Phase-Change Material $\lambda=3,4W/mK$						1,13		K/W
-------------------------------------	---------------	---	--	--	--	--	--	------	--	-----

#### IGBT Switching

Turn-on delay time	$t_{d(on)}$	$R_{goff} = 8 \Omega$ $R_{gon} = 8 \Omega$	±15	300	50	25		59		ns
Rise time	$t_r$					125		60		
Turn-off delay time	$t_{d(off)}$					150		60		
Fall time	$t_f$					25		9		
Turn-on energy (per pulse)	$E_{on}$	$Q_{rFWD} = 0,8 \mu C$ $Q_{rFWD} = 1,8 \mu C$ $Q_{rFWD} = 2,2 \mu C$				25		0,412	mWs	
Turn-off energy (per pulse)	$E_{off}$				125		0,516			
					150		0,555			
					25		0,170			
					125		0,303			
					150		0,337			



# Vincotech

## Inverter Diode

Parameter	Symbol	Conditions					Value			Unit
		$V_r$ [V]	$I_F$ [A]	$T_j$ [°C]	Min	Typ	Max			
<b>Static</b>										
Forward voltage	$V_F$		30	25 125 150			2,46 2,03 -	2,6		V
Reverse leakage current	$I_r$		665	25 150				10 -		μA

### Thermal

Thermal resistance junction to sink	$R_{th(j-s)}$	Phase-Change Material $\lambda=3,4W/mK$					1,83			K/W
-------------------------------------	---------------	--	--	--	--	--	------	--	--	-----

### FWD Switching

Peak recovery current	$I_{RRM}$	$di/dt = 4872 A/\mu s$ $di/dt = 4560 A/\mu s$ $di/dt = 4066 A/\mu s$	$\pm 15$	300	50	25		39		A
Reverse recovery time	$t_{rr}$					125		47		ns
						150		49		
						25		20		
Recovered charge	$Q_r$					125		0,783		μC
						150		1,798		
		25		2,183						
Reverse recovered energy	$E_{rec}$	125		0,133		mWs				
		150		0,376						
		25		0,466						
Peak rate of fall of recovery current	$(di_{rr}/dt)_{max}$	125		6525		A/μs				
		150		3267						
		25		2773						

## Thermistor

Parameter	Symbol	Conditions					Value			Unit
		$V_{GE}$ [V]	$V_{CE}$ [V]	$I_C$ [A]	$T_j$ [°C]	Min	Typ	Max		
Rated resistance	R				25		22			kΩ
Deviation of R100	$\Delta_{R/R}$	R100=1486 Ω			100	-12		+12		%
Power dissipation	P				25		200			mW
Power dissipation constant					25		2			mW/K
B-value	$B_{(25/50)}$	Tol. ±3%			25		3950			K
B-value	$B_{(25/100)}$	Tol. ±3%			25		3998			K
Vincotech NTC Reference								B		



## H-bridge Switch Characteristics

Typical output characteristics IGBT

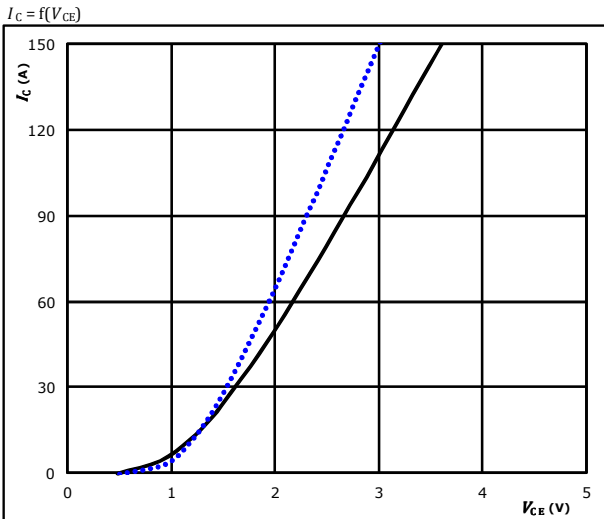

$t_p = 250 \mu s$   
 $V_{GE} = 15 V$   
 25 °C (dotted blue line)  
 125 °C (solid black line)  
 150 °C (dashed red line)

Typical output characteristics IGBT

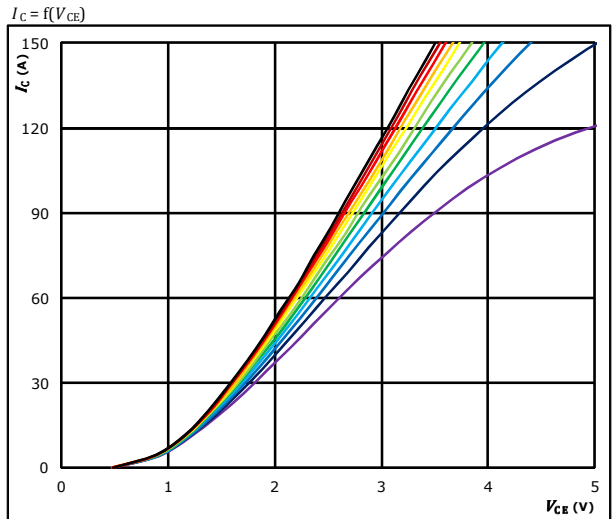

$t_p = 250 \mu s$   
 $T_j = 125 \text{ °C}$   
 $V_{GE}$  from 8 V to 18 V in steps of 1 V

Typical transfer characteristics IGBT

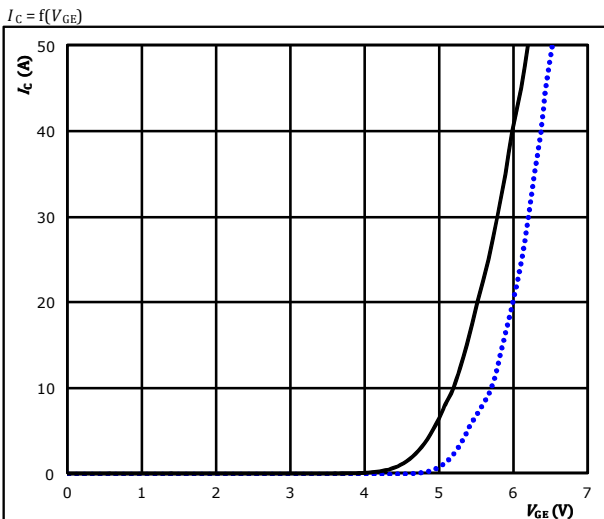

$t_p = 100 \mu s$   
 $V_{CE} = 10 V$   
 25 °C (dotted blue line)  
 125 °C (solid black line)  
 150 °C (dashed red line)

Transient Thermal Impedance as function of Pulse duration IGBT

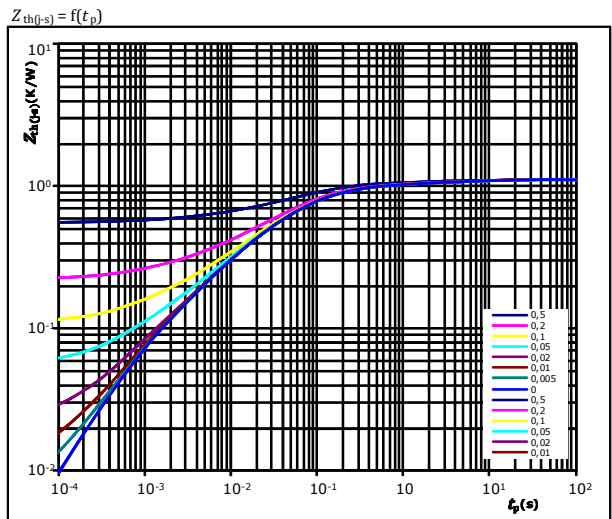

$D = t_p / T$   
 $R_{th(j-s)} = 1,13 \text{ K/W}$   
 IGBT thermal model values

$R_{th} \text{ (K/W)}$	$\tau \text{ (s)}$
7,12E-02	8,15E+00
1,29E-01	6,00E-01
4,31E-01	9,13E-02
3,15E-01	2,59E-02
1,31E-01	5,80E-03
5,02E-02	8,53E-04



Vincotech

### H-bridge Switch Characteristics

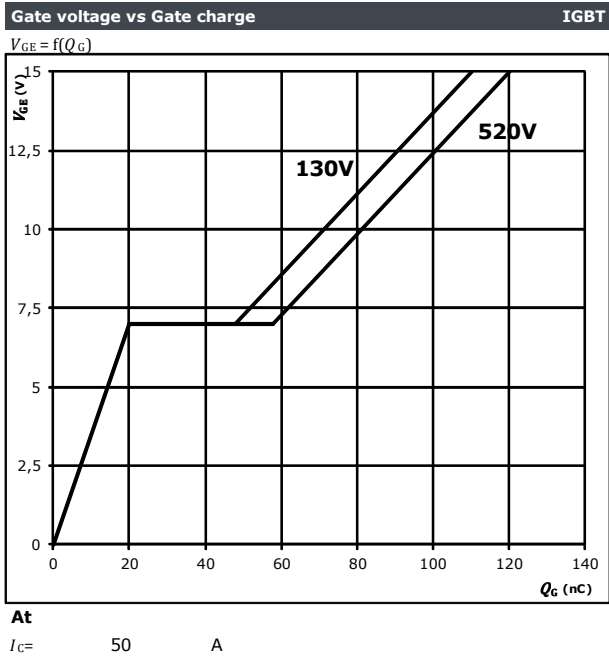



## H-bridge Diode Characteristics

**Typical forward characteristics** FWD

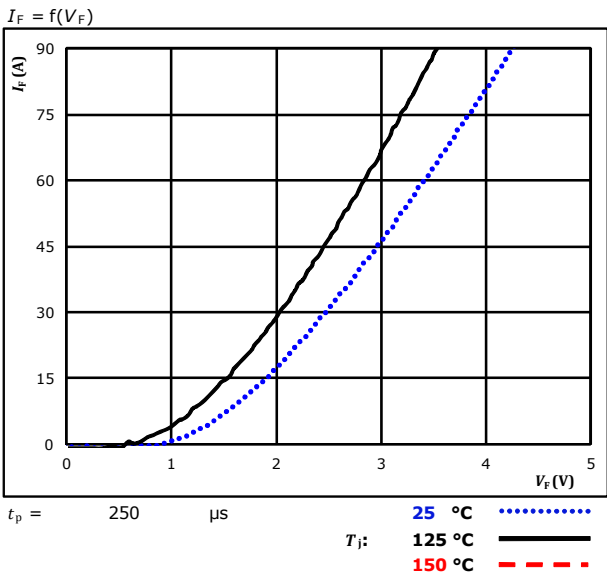

**Transient thermal impedance as a function of pulse width** FWD

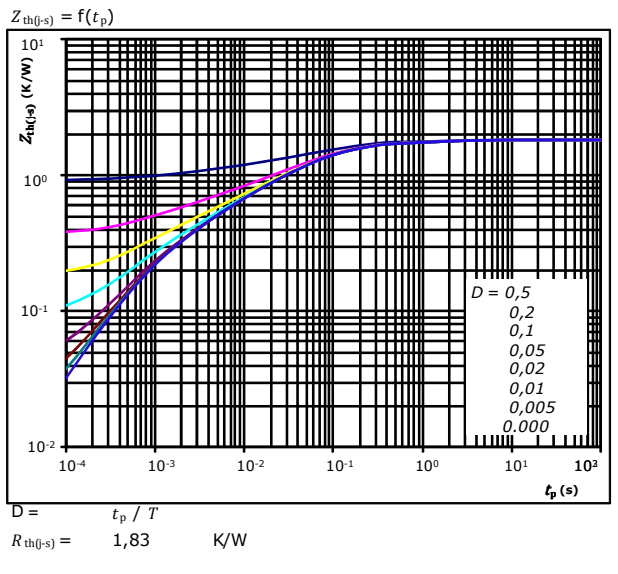

FWD thermal model values

R (K/W)	$\tau$ (s)
6,05E-02	3,63E+00
1,50E-01	6,48E-01
8,27E-01	7,70E-02
4,06E-01	1,51E-02
2,16E-01	3,45E-03
1,73E-01	7,36E-04

## Thermistor Characteristics

**Thermistor typical temperature characteristic**  
**Typical NTC characteristic**  
**as a function of temperature**

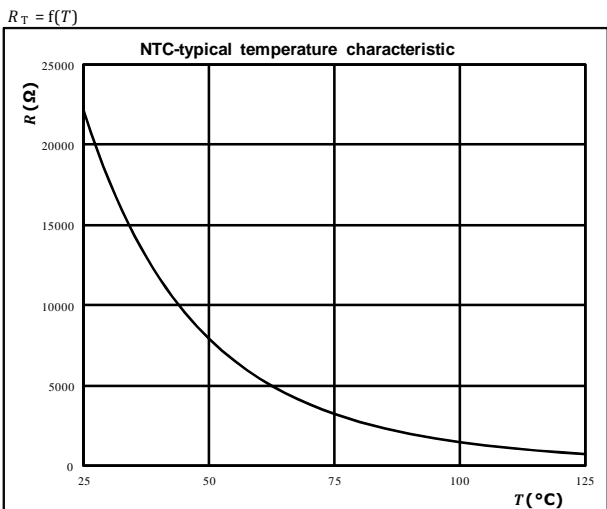



## H-bridge Switching Characteristics

**Figure 1.** IGBT  
Typical switching energy losses as a function of collector current

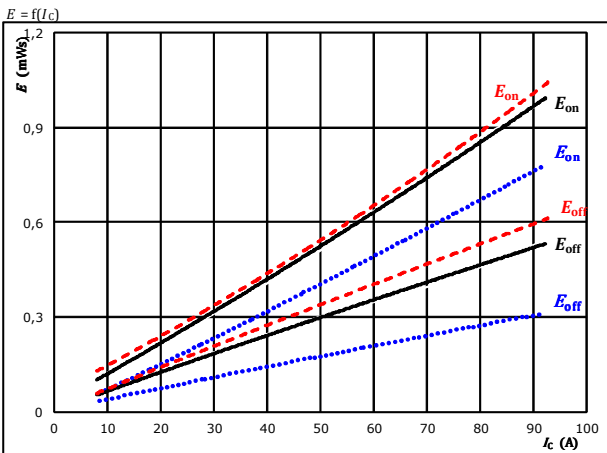

With an inductive load at  
 $V_{CE} = 300$  V  
 $V_{GE} = \pm 15$  V  
 $R_{gon} = 8$   $\Omega$   
 $R_{goff} = 8$   $\Omega$   
 $T_j$ : 25 °C (dotted blue), 125 °C (solid black), 150 °C (dashed red)

**Figure 2.** IGBT  
Typical switching energy losses as a function of gate resistor

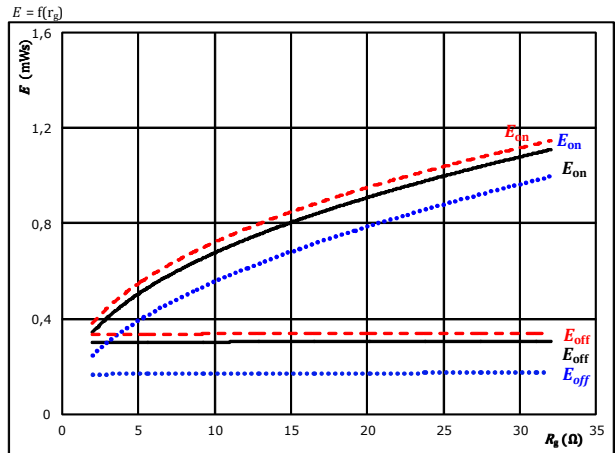

With an inductive load at  
 $V_{CE} = 300$  V  
 $V_{GE} = \pm 15$  V  
 $I_C = 50$  A  
 $T_j$ : 25 °C (dotted blue), 125 °C (solid black), 150 °C (dashed red)

**Figure 3.** FWD  
Typical reverse recovered energy loss as a function of collector current

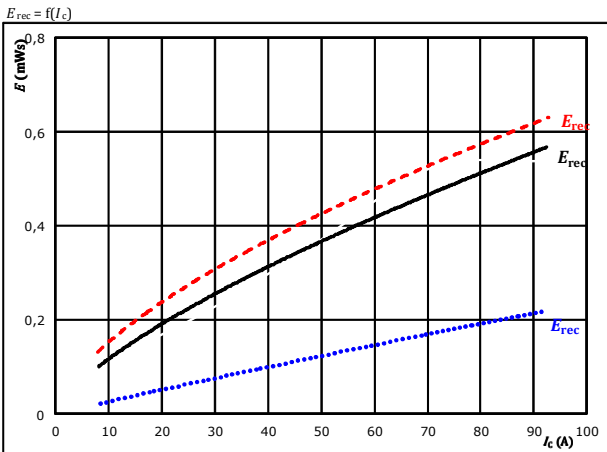

With an inductive load at  
 $V_{CE} = 300$  V  
 $V_{GE} = \pm 15$  V  
 $R_{gon} = 8$   $\Omega$   
 $T_j$ : 25 °C (dotted blue), 125 °C (solid black), 150 °C (dashed red)

**Figure 4.** FWD  
Typical reverse recovered energy loss as a function of gate resistor

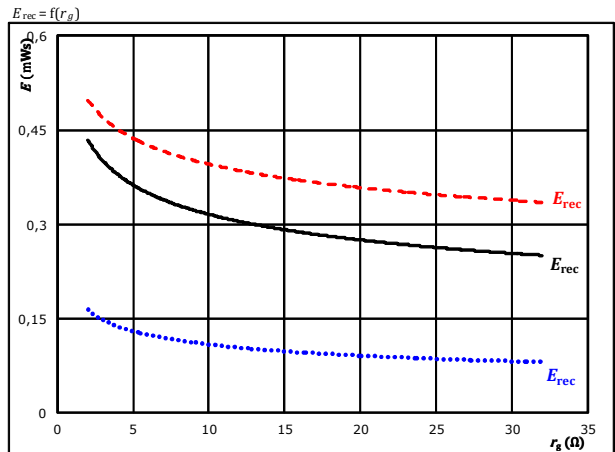

With an inductive load at  
 $V_{CE} = 300$  V  
 $V_{GE} = \pm 15$  V  
 $I_C = 50$  A  
 $T_j$ : 25 °C (dotted blue), 125 °C (solid black), 150 °C (dashed red)





## H-bridge Switching Characteristics

**Figure 5.** IGBT  
Typical switching times as a function of collector current

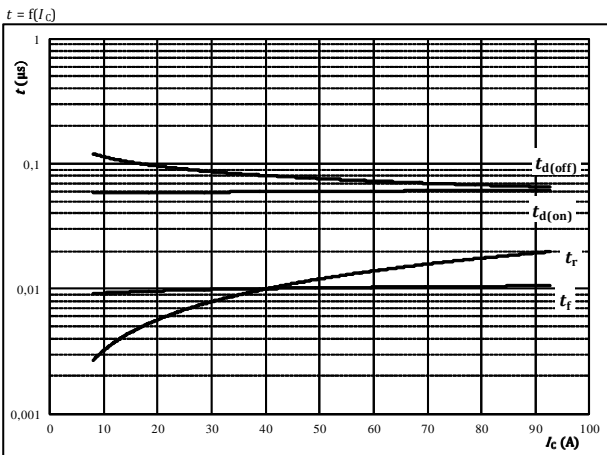

With an inductive load at

$T_j =$	150	°C
$V_{CE} =$	300	V
$V_{GE} =$	±15	V
$R_{gon} =$	8	Ω
$R_{goff} =$	8	Ω

**Figure 6.** IGBT  
Typical switching times as a function of gate resistor

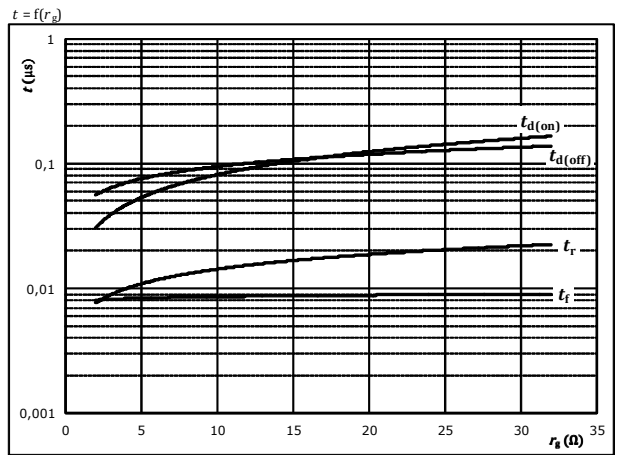

With an inductive load at

$T_j =$	150	°C
$V_{CE} =$	300	V
$V_{GE} =$	±15	V
$I_C =$	50	A

**Figure 7.** FWD  
Typical reverse recovery time as a function of collector current

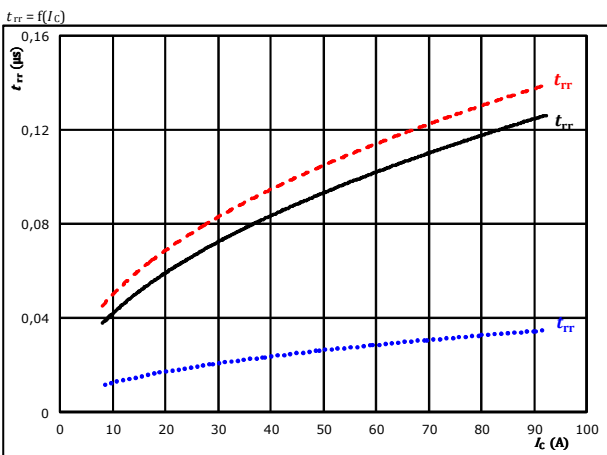

At	$V_{CE} =$	300	V	$T_j:$	25 °C	.....
	$V_{GE} =$	±15	V		125 °C	————
	$R_{gon} =$	8	Ω		150 °C	- - - -

**Figure 8.** FWD  
Typical reverse recovery time as a function of IGBT turn on gate resistor

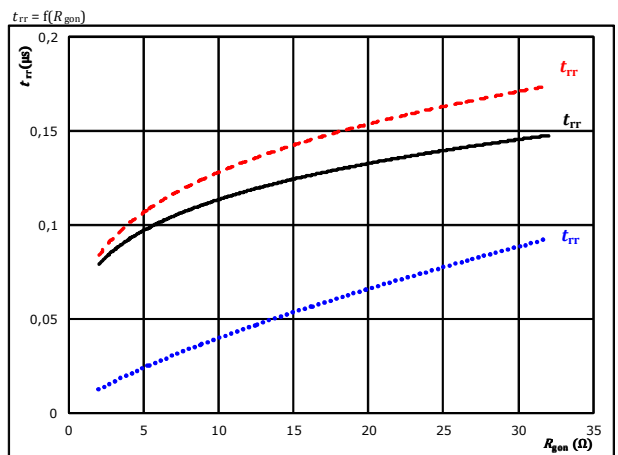

At	$V_{CE} =$	300	V	$T_j:$	25 °C	.....
	$V_{GE} =$	±15	V		125 °C	————
	$I_C =$	50	A		150 °C	- - - -



## H-bridge Switching Characteristics

**Figure 9.** FWD  
Typical recovered charge as a function of collector current

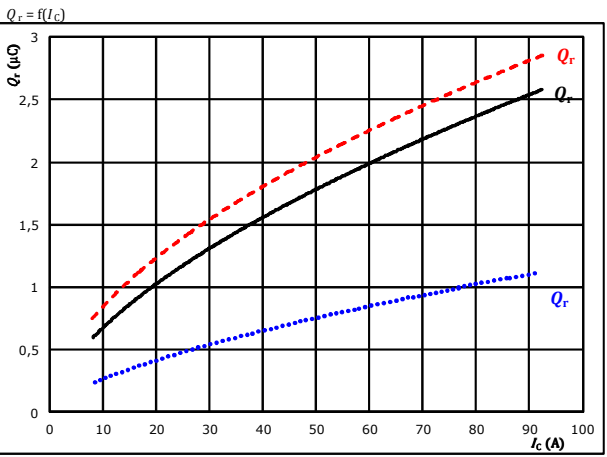

At  $V_{CE} = 300$  V  
 $V_{GE} = \pm 15$  V  
 $R_{gon} = 8$   $\Omega$   
 $T_j$ : 25 °C (dotted blue)  
 125 °C (solid black)  
 150 °C (dashed red)

**Figure 10.** FWD  
Typical recovered charge as a function of IGBT turn on gate resistor

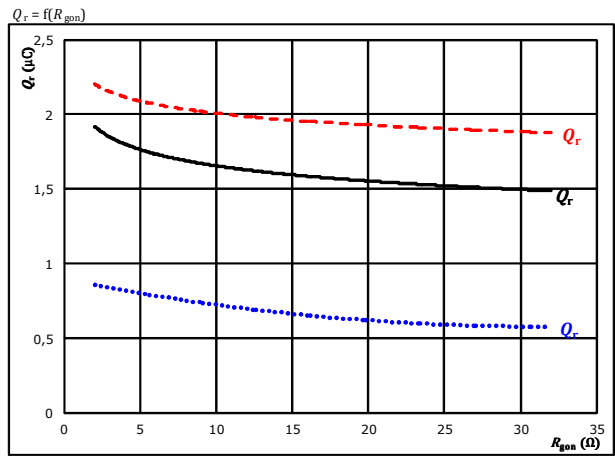

At  $V_{CE} = 300$  V  
 $V_{GE} = \pm 15$  V  
 $I_c = 50$  A  
 $T_j$ : 25 °C (dotted blue)  
 125 °C (solid black)  
 150 °C (dashed red)

**Figure 11.** FWD  
Typical peak reverse recovery current as a function of collector current

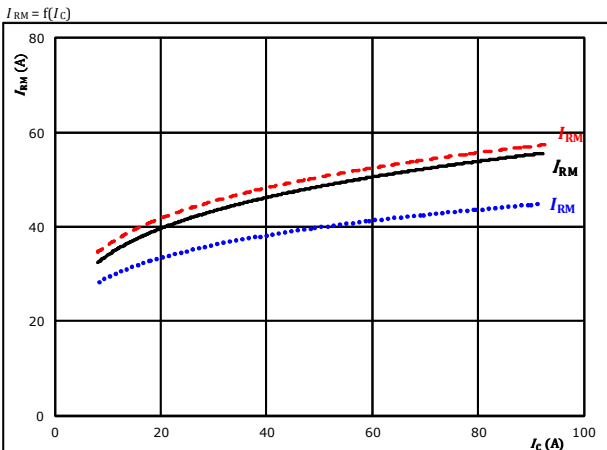

At  $V_{CE} = 300$  V  
 $V_{GE} = \pm 15$  V  
 $R_{gon} = 8$   $\Omega$   
 $T_j$ : 25 °C (dotted blue)  
 125 °C (solid black)  
 150 °C (dashed red)

**Figure 12.** FWD  
Typical peak reverse recovery current as a function of IGBT turn on gate resistor

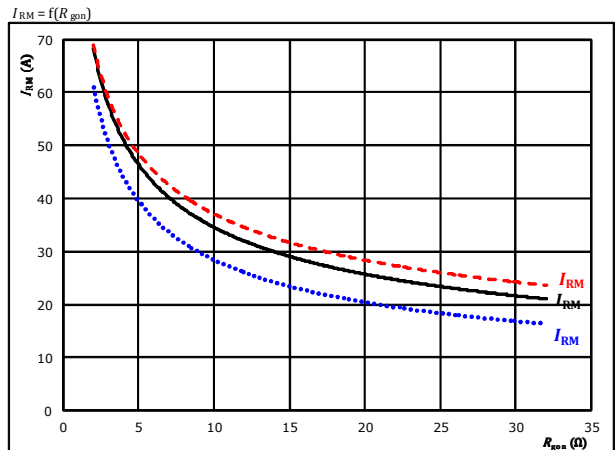

At  $V_{CE} = 300$  V  
 $V_{GE} = \pm 15$  V  
 $I_c = 50$  A  
 $T_j$ : 25 °C (dotted blue)  
 125 °C (solid black)  
 150 °C (dashed red)



## H-bridge Switching Characteristics

**Figure 13.** FWD

Typical rate of fall of forward and reverse recovery current as a function of collector current

$$di_F/dt, di_{rr}/dt = f(I_c)$$

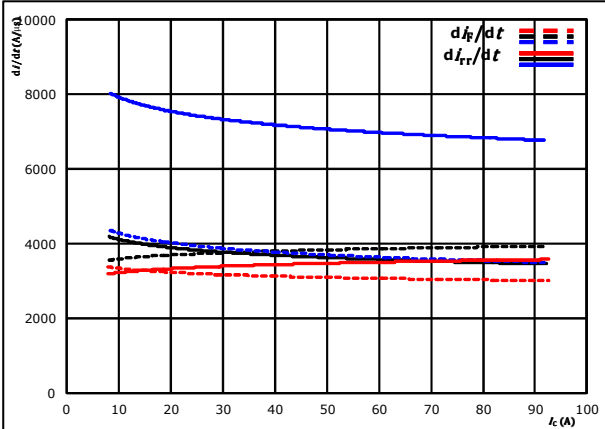

At  $V_{CE} = 300$  V  
 $V_{GE} = \pm 15$  V  
 $R_{gon} = 8$   $\Omega$   
 $T_j = 25$  °C  
 $125$  °C  
 $150$  °C

**Figure 14.** FWD

Typical rate of fall of forward and reverse recovery current as a function of IGBT turn on gate resistor

$$di_F/dt, di_{rr}/dt = f(R_g)$$

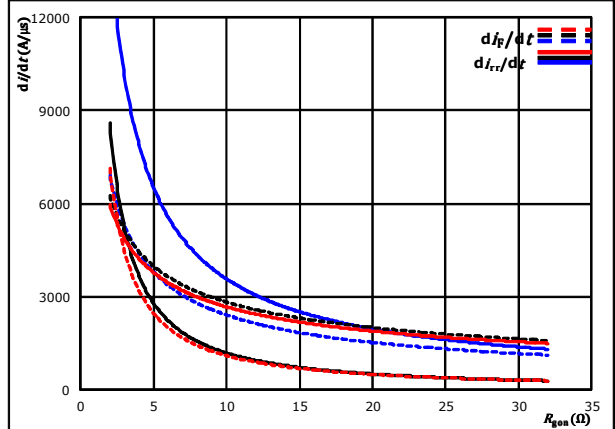

At  $V_{CE} = 300$  V  
 $V_{GE} = \pm 15$  V  
 $I_c = 50$  A

**Figure 15.** IGBT

Reverse bias safe operating area

$$I_c = f(V_{ce})$$

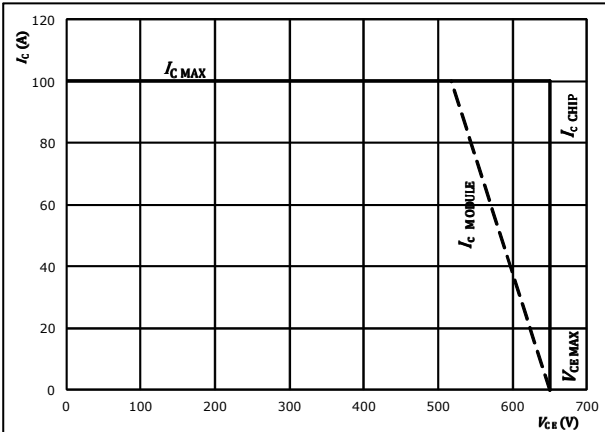

At  $T_j = 175$  °C  
 $R_{gon} = 8$   $\Omega$   
 $R_{goff} = 8$   $\Omega$



## H-bridge Switching Definitions

**General conditions**

$T_j$	=	150 °C
$R_{gon}$	=	8 $\Omega$
$R_{goff}$	=	8 $\Omega$

**Figure 1.** IGBT  
Turn-off Switching Waveforms & definition of  $t_{doff}$ ,  $t_{Eoff}$  ( $t_{Eoff}$  = integrating time for Eoff)

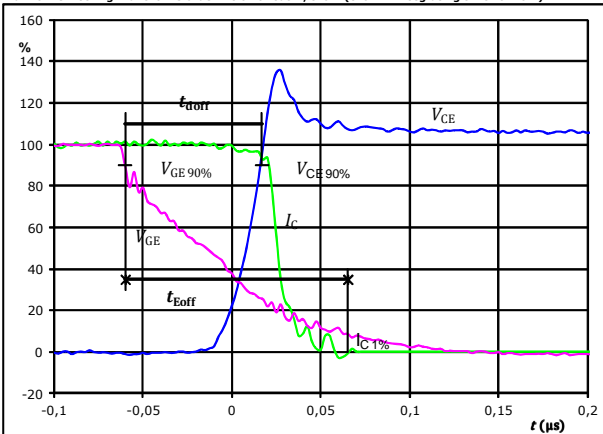

$V_{CE}(0\%) =$	-15	V
$V_{GE}(100\%) =$	15	V
$V_C(100\%) =$	300	V
$I_C(100\%) =$	50	A
$t_{doff} =$	0,076	$\mu s$
$t_{Eoff} =$	0,125	$\mu s$

**Figure 2.** IGBT  
Turn-on Switching Waveforms & definition of  $t_{don}$ ,  $t_{Eon}$  ( $t_{Eon}$  = integrating time for Eon)

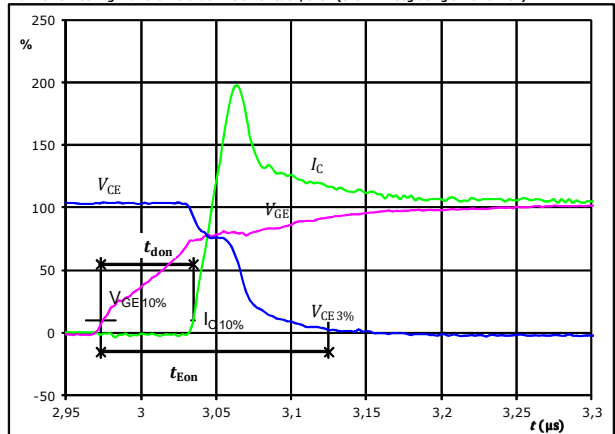

$V_{CE}(0\%) =$	-15	V
$V_{GE}(100\%) =$	15	V
$V_C(100\%) =$	300	V
$I_C(100\%) =$	50	A
$t_{don} =$	0,060	$\mu s$
$t_{Eon} =$	0,152	$\mu s$

**Figure 3.** IGBT  
Turn-off Switching Waveforms & definition of  $t_f$

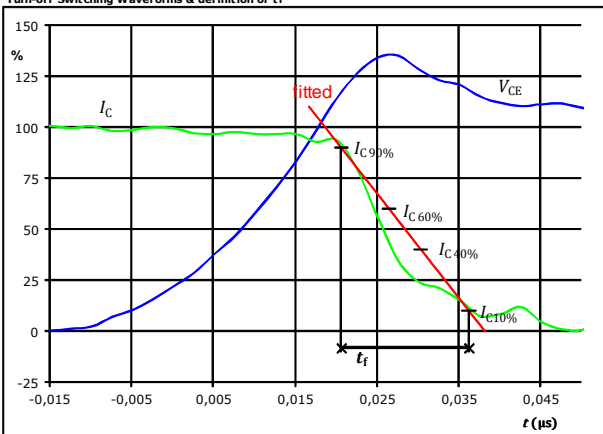

$V_C(100\%) =$	300	V
$I_C(100\%) =$	50	A
$t_f =$	0,009	$\mu s$

**Figure 4.** IGBT  
Turn-on Switching Waveforms & definition of  $t_r$

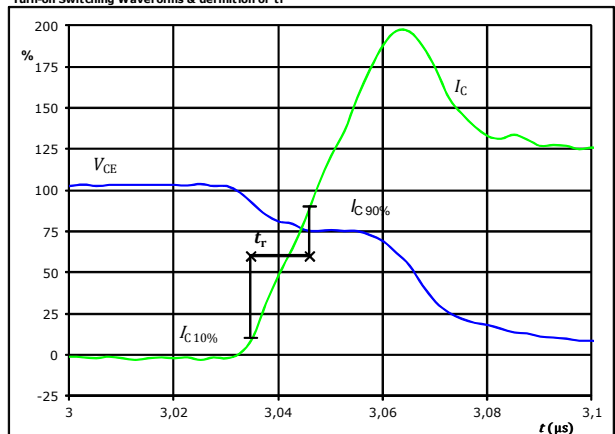

$V_C(100\%) =$	300	V
$I_C(100\%) =$	50	A
$t_r =$	0,011	$\mu s$



Vincotech

## H-bridge Switching Definitions

**Figure 5.** IGBT

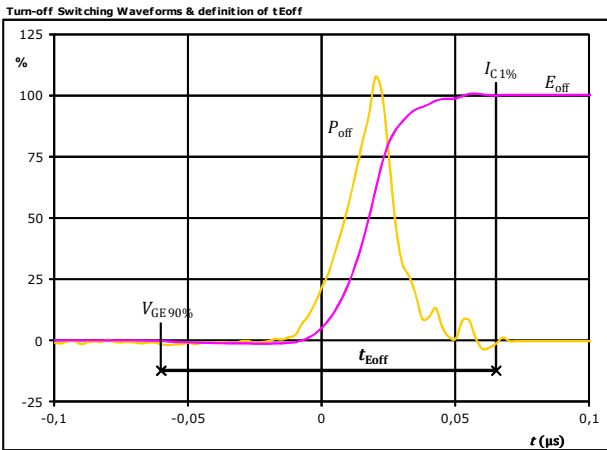

$P_{off}(100\%) = 14,99$  kW  
 $E_{off}(100\%) = 0,34$  mJ  
 $t_{Eoff} = 0,13$  μs

**Figure 6.** IGBT

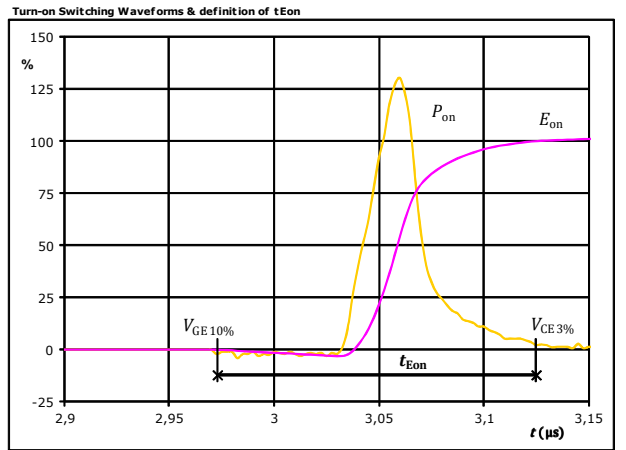

$P_{on}(100\%) = 14,99$  kW  
 $E_{on}(100\%) = 0,56$  mJ  
 $t_{Eon} = 0,15$  μs

**Figure 7.** FWD

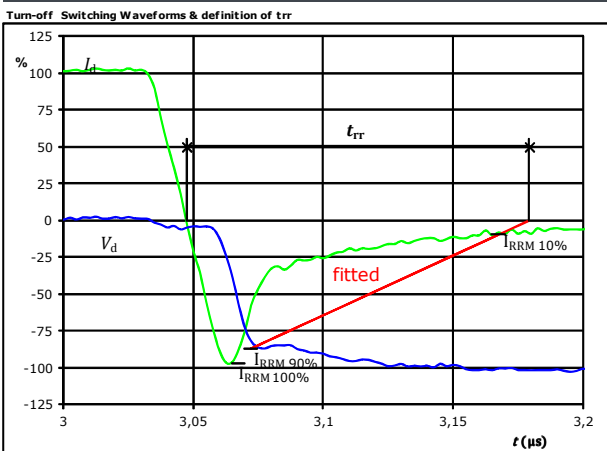

$V_d(100\%) = 300$  V  
 $I_d(100\%) = 50$  A  
 $I_{RRM}(100\%) = -49$  A  
 $t_{tr} = 0,117$  μs



Vincotech

## H-bridge Switching Definitions

**Figure 8.** FWD

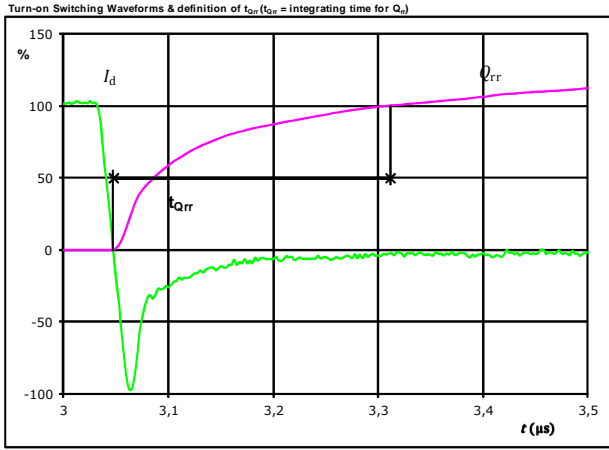

$I_d(100\%) =$	50	A
$Q_{rr}(100\%) =$	2,18	$\mu\text{C}$
$t_{Qrr} =$	0,26	$\mu\text{s}$

**Figure 9.** FWD

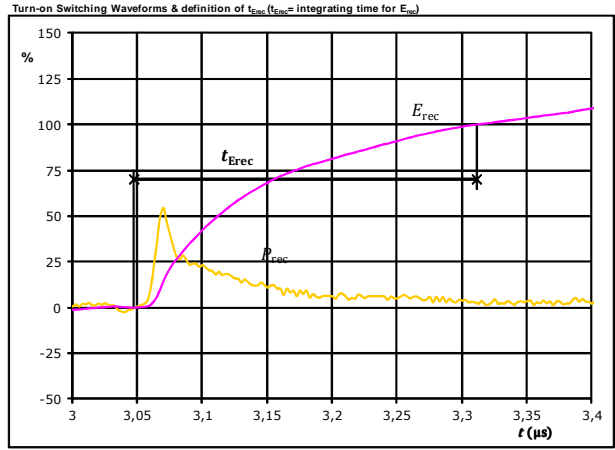

$P_{rec}(100\%) =$	14,99	kW
$E_{rec}(100\%) =$	0,47	mJ
$t_{Erec} =$	0,26	$\mu\text{s}$



Vincotech

Ordering Code & Marking							
Version	Ordering Code	in DataMatrix as	in packaging barcode as				
without thermal paste 12mm housing	10-FY074PA050SM-M582F38	M582F38	M582F38				
NN-NNNNNNNNNNNNNN NNNNNNNN WWYY UL Vinco LLLLL SSSS		<b>Text</b>	<b>Name</b>	<b>Date code</b>	<b>UL &amp; Vinco</b>	<b>Lot</b>	<b>Serial</b>
			NN-NNNNNNNNNNNNNN-NNNNNNNN	WWYY	UL Vinco	LLLLL	SSSS
		<b>Datamatrix</b>	<b>Type&amp;Ver</b>	<b>Lot number</b>	<b>Serial</b>	<b>Date code</b>	
			TTTTTTVV	LLLLL	SSSS	WWYY	

Pin table [mm]			
Pin	X	Y	Function
1	0	28,2	G11
2	3	28,2	S11
3	23,55	28,2	Therm1
4	28,65	28,2	Therm2
5	49,2	28,2	S13
6	52,2	28,2	G13
7	52,2	20,25	DC-2
8	52,2	17,75	DC-2
9	52,2	10,5	DC+
10	52,2	8	DC+
11	52,2	0	G14
12	49,2	0	S14
13	43,2	0	Ph2
14	40,7	0	Ph2
15	38,2	0	Ph2
16	14	0	Ph1
17	11,5	0	Ph1
18	9	0	Ph1
19	3	0	S12
20	0	0	G12
21	0	8	DC+
22	0	10,5	DC+
23	0	17,75	DC-1
24	0	20,25	DC-1



Vincotech

**Pinout**

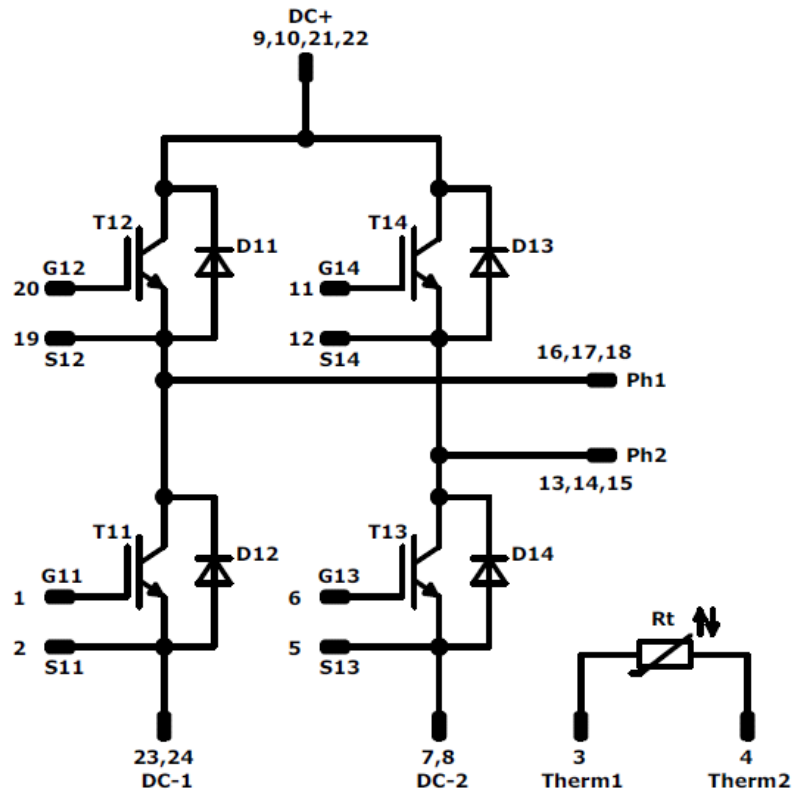

**Identification**

ID	Component	Voltage	Current	Function	Comment
T11,T12,T13,T14	IGBT	650V	50A	H-bridge Switch	
D11,D12,D13,D14	FWD	650V	30A	H-bridge Diode	
Rt	NTC	-	-	Thermistor	





Vincotech

Packaging instruction					
Standard packaging quantity (SPQ)	100	>SPQ	Standard	<SPQ	Sample

Handling instruction	
Handling instructions for <i>flow</i> 1 packages see vincotech.com website.	

Document No.:	Date:	Modification:	Pages
10-FY074PA050SM-M582F38-D2-14	23 Jul. 2015		

**DISCLAIMER**

The information, specifications, procedures, methods and recommendations herein (together "information") are presented by Vincotech to reader in good faith, are believed to be accurate and reliable, but may well be incomplete and/or not applicable to all conditions or situations that may exist or occur. Vincotech reserves the right to make any changes without further notice to any products to improve reliability, function or design. No representation, guarantee or warranty is made to reader as to the accuracy, reliability or completeness of said information or that the application or use of any of the same will avoid hazards, accidents, losses, damages or injury of any kind to persons or property or that the same will not infringe third parties rights or give desired results. It is reader's sole responsibility to test and determine the suitability of the information and the product for reader's intended use.

**LIFE SUPPORT POLICY**

Vincotech products are not authorised for use as critical components in life support devices or systems without the express written approval of Vincotech.

As used herein:

1. Life support devices or systems are devices or systems which, (a) are intended for surgical implant into the body, or (b) support or sustain life, or (c) whose failure to perform when properly used in accordance with instructions for use provided in labelling can be reasonably expected to result in significant injury to the user.
2. A critical component is any component of a life support device or system whose failure to perform can be reasonably expected to cause the failure of the life support device or system, or to affect its safety or effectiveness.