

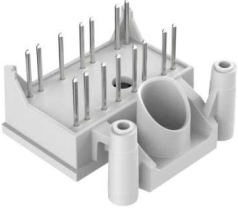
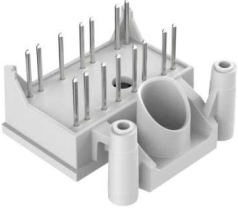
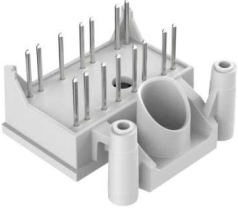
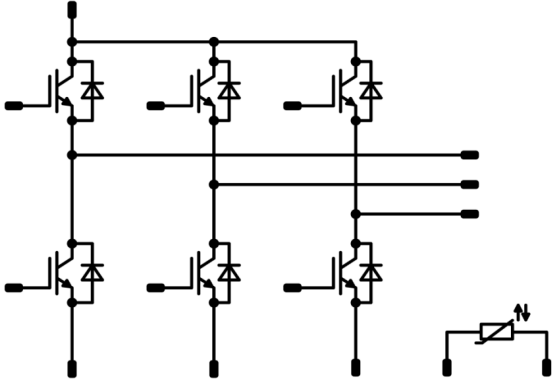
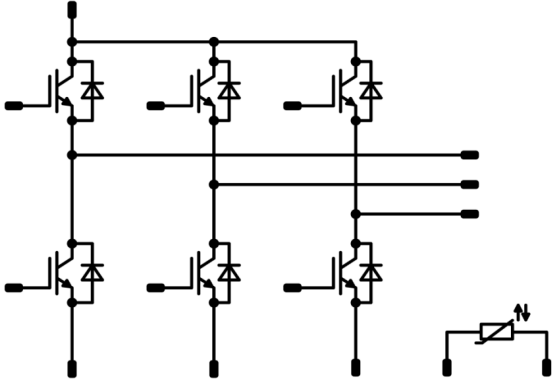
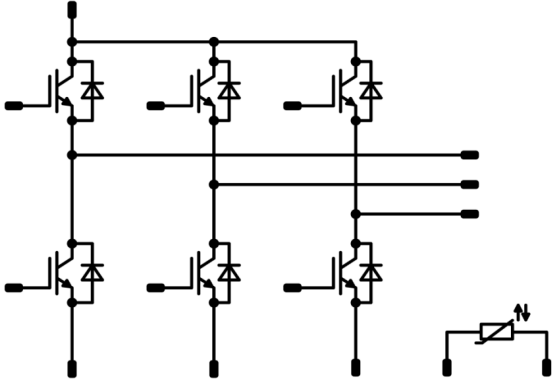

Vincotech

flow PACK 0B	600 V / 30 A				
<table border="1" style="width: 100%; border-collapse: collapse;"> <tr> <th style="background-color: #cccccc;">Features</th> </tr> <tr> <td style="padding: 5px;"> <ul style="list-style-type: none"> IGBT3 (600 V) technology Open emitter topology New ultra-compact housing Single-screw heat sink mounting </td> </tr> </table>	Features	<ul style="list-style-type: none"> IGBT3 (600 V) technology Open emitter topology New ultra-compact housing Single-screw heat sink mounting 	<table border="1" style="width: 100%; border-collapse: collapse;"> <tr> <th style="background-color: #cccccc;">flow 0 B 17mm housing</th> </tr> <tr> <td style="text-align: center; padding: 10px;">  </td> </tr> </table>	flow 0 B 17mm housing	
Features					
<ul style="list-style-type: none"> IGBT3 (600 V) technology Open emitter topology New ultra-compact housing Single-screw heat sink mounting 					
flow 0 B 17mm housing					
					
<table border="1" style="width: 100%; border-collapse: collapse;"> <tr> <th style="background-color: #cccccc;">Target applications</th> </tr> <tr> <td style="padding: 5px;"> <ul style="list-style-type: none"> Dedicated design for motor drive </td> </tr> </table>	Target applications	<ul style="list-style-type: none"> Dedicated design for motor drive 	<table border="1" style="width: 100%; border-collapse: collapse;"> <tr> <th style="background-color: #cccccc;">Schematic</th> </tr> <tr> <td style="text-align: center; padding: 10px;">  </td> </tr> </table>	Schematic	
Target applications					
<ul style="list-style-type: none"> Dedicated design for motor drive 					
Schematic					
					
<table border="1" style="width: 100%; border-collapse: collapse;"> <tr> <th style="background-color: #cccccc;">Types</th> </tr> <tr> <td style="padding: 5px;"> <ul style="list-style-type: none"> 10-0B066PA030SB-M996F09 </td> </tr> </table>	Types	<ul style="list-style-type: none"> 10-0B066PA030SB-M996F09 			
Types					
<ul style="list-style-type: none"> 10-0B066PA030SB-M996F09 					

Maximum Ratings

$T_j = 25\text{ }^\circ\text{C}$, unless otherwise specified

Parameter	Symbol	Condition	Value	Unit
Inverter Switch				
Collector-emitter voltage	V_{CES}		600	V
Collector current	I_C	$T_j = T_{jmax}$ $T_s = 80\text{ }^\circ\text{C}$	34	A
Repetitive peak collector current	I_{CRM}	t_p limited by T_{jmax}	90	A
Turn off safe operating area		$T_j \leq 150\text{ }^\circ\text{C}$, $V_{CE} \leq 1200\text{ V}$	90	A
Total power dissipation	P_{tot}	$T_j = T_{jmax}$ $T_s = 80\text{ }^\circ\text{C}$	68	W
Gate-emitter voltage	V_{GES}		± 20	V
Short circuit ratings	t_{SC}	$T_j \leq 150\text{ }^\circ\text{C}$	6	μs
	V_{CC}	$V_{GE} = 15\text{ V}$	360	V
Maximum junction temperature	T_{jmax}		175	$^\circ\text{C}$



Vincotech

Maximum Ratings

$T_j = 25\text{ °C}$, unless otherwise specified

Parameter	Symbol	Condition	Value	Unit
Inverter Diode				
Peak repetitive reverse voltage	V_{RRM}		600	V
Continuous (direct) forward current	I_F	$T_j = T_{jmax}$ $T_s = 80\text{ °C}$	32	A
Total power dissipation	P_{tot}	$T_j = T_{jmax}$ $T_s = 80\text{ °C}$	53	W
Maximum junction temperature	T_{jmax}		175	°C

Module Properties

Thermal Properties

Storage temperature	T_{stg}		-40...+125	°C
Operation temperature under switching condition	T_{jop}		-40...($T_{jmax} - 25$)	°C

Isolation Properties

Isolation voltage	V_{isol}	DC Test Voltage $t_p = 2\text{ s}$	4000	V
Creepage distance			min. 12,7	mm
Clearance			min. 12,7	mm
Comparative Tracking Index	CTI		> 200	



Vincotech

Characteristic Values

Parameter	Symbol	Conditions					Value			Unit
		V_{GS} [V]	V_{GE} [V]	V_{DS} [V]	I_D [A]	T_j [°C]	Min	Typ	Max	

Inverter Switch

Static

Parameter	Symbol	Conditions	V_{GS} [V]	V_{GE} [V]	V_{DS} [V]	I_D [A]	T_j [°C]	Min	Typ	Max	Unit
Gate-emitter threshold voltage	$V_{GE(th)}$	$V_{GE} = V_{CE}$				0,00043	25	5	5,8	6,5	V
Collector-emitter saturation voltage	V_{CEsat}		15			30	25 125	1,1	1,51 1,71	1,9	V
Collector-emitter cut-off current	I_{CES}		0	600			25			1,6	μA
Gate-emitter leakage current	I_{GES}		20	0			25			300	nA
Internal gate resistance	r_g								none		Ω
Input capacitance	C_{ies}								1630		pF
Output capacitance	C_{oes}	$f = 1$ MHz	0	25		25			108		
Reverse transfer capacitance	C_{res}								50		
Gate charge	Q_g		15	400	30		25		167		nC

Thermal

Parameter	Symbol	Conditions	V_{GS} [V]	V_{GE} [V]	V_{DS} [V]	I_D [A]	T_j [°C]	Min	Typ	Max	Unit
Thermal resistance junction to sink	$R_{th(j-s)}$	Thermal grease thickness ≤ 50 μm $\lambda = 1$ W/mK							1,41		K/W

Dynamic

Parameter	Symbol	Conditions	V_{GS} [V]	V_{GE} [V]	V_{DS} [V]	I_D [A]	T_j [°C]	Min	Typ	Max	Unit
Turn-on delay time	$t_{d(on)}$	$R_{goff} = 16 \Omega$ $R_{gon} = 16 \Omega$	±15	300	30			25	106		ns
Rise time	t_r							150	104		
Turn-off delay time	$t_{d(off)}$							25	14		
Fall time	t_f							150	20		
Turn-on energy (per pulse)	E_{on}	$Q_{rFWD} = 1,3 \mu C$ $Q_{rFWD} = 2,7 \mu C$						25	0,475		mWs
Turn-off energy (per pulse)	E_{off}							150	0,665		
								25	0,675		
								150	0,913		



Vincotech

Characteristic Values

Parameter	Symbol	Conditions					Value			Unit
		V_{GS} [V]	V_{GE} [V]	V_{DS} [V]	I_D [A]	I_C [A]	T_j [°C]	Min	Typ	

Inverter Diode

Static

Forward voltage	V_F				30	25 125		1,65 1,62	1,95	V
Reverse leakage current	I_R			600		25			27	μA

Thermal

Thermal resistance junction to sink	$R_{th(j-s)}$	Thermal grease thickness $\leq 50 \mu\text{m}$ $\lambda = 1 \text{ W/mK}$						1,80		K/W
-------------------------------------	---------------	------------------------------------------------------------------------------	--	--	--	--	--	------	--	-----

Dynamic

Peak recovery current	I_{RRM}	$di/dt = 2285 \text{ A}/\mu\text{s}$ $di/dt = 1902 \text{ A}/\mu\text{s}$	± 15	300	30	25 150		27 34		A
Reverse recovery time	t_{rr}					25 150		146 253		ns
Recovered charge	Q_r					25 150		1,338 2,654		μC
Reverse recovered energy	E_{rec}					25 150		0,290 0,568		mWs
Peak rate of fall of recovery current	$(di_{rr}/dt)_{max}$					25 150		1752 815		A/μs

Thermistor

Rated resistance	R					25		21,5		kΩ
Deviation of R_{100}	$\Delta_{R/R}$	$R_{100} = 1486 \Omega$				100	-4,5		+4,5	%
Power dissipation	P					25		210		mW
Power dissipation constant						25		3,5		mW/K
B-value	$B_{(25/50)}$					25		3884		K
B-value	$B_{(25/100)}$					25		3964		K
Vincotech NTC Reference									F	



Inverter Switch Characteristics

figure 1. IGBT

Typical output characteristics

$$I_C = f(V_{CE})$$

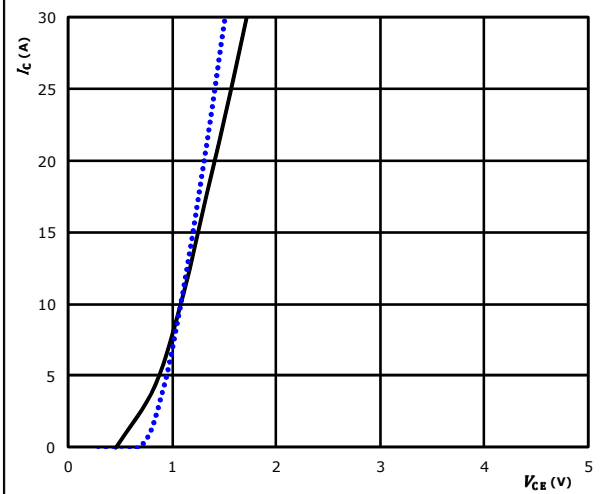

$t_p = 250 \mu s$ $T_j: 25 \text{ }^\circ C$ (dotted blue line)
 $V_{GE} = 15 V$ $T_j: 125 \text{ }^\circ C$ (solid black line)

figure 2. IGBT

Typical output characteristics

$$I_C = f(V_{CE})$$

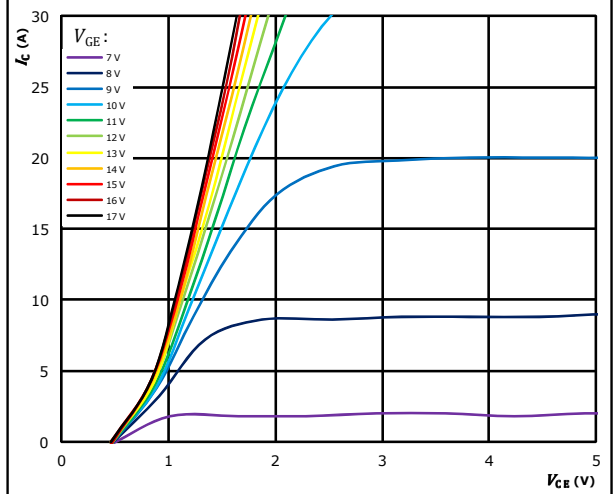

$t_p = 250 \mu s$
 $T_j = 125 \text{ }^\circ C$
 V_{GE} from 7 V to 17 V in steps of 1 V

figure 3. IGBT

Typical transfer characteristics

$$I_C = f(V_{GE})$$

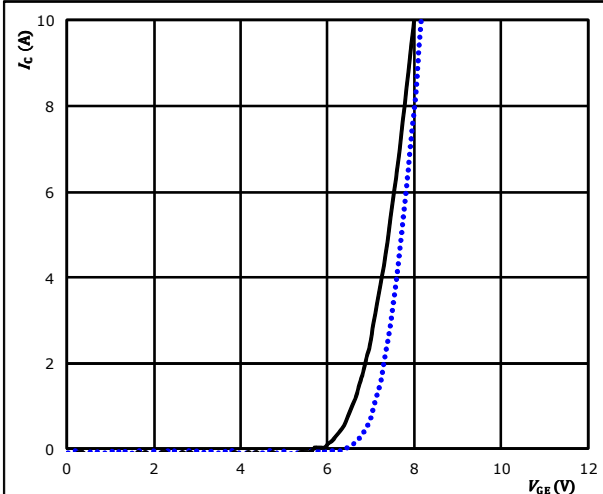

$t_p = 100 \mu s$ $T_j: 25 \text{ }^\circ C$ (dotted blue line)
 $V_{CE} = 10 V$ $T_j: 125 \text{ }^\circ C$ (solid black line)

figure 4. IGBT

Transient thermal impedance as function of pulse duration

$$Z_{th(j-s)} = f(t_p)$$

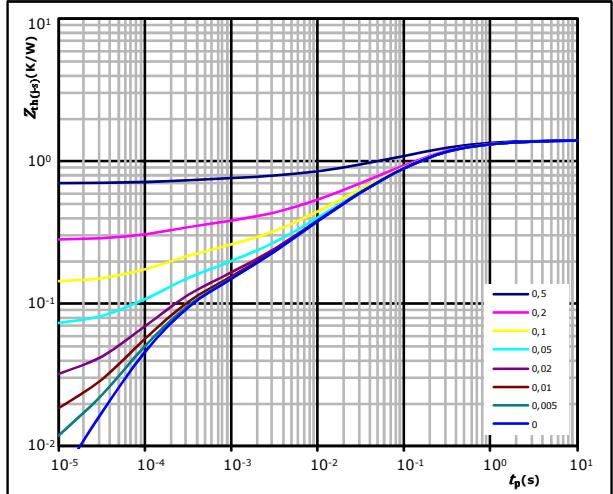

$D = t_p / T$
 $R_{th(j-s)} = 1,41 \text{ K/W}$

IGBT thermal model values

R (K/W)	τ (s)
3,67E-02	9,82E+00
1,46E-01	1,04E+00
5,44E-01	1,78E-01
3,36E-01	4,31E-02
2,08E-01	8,55E-03
6,31E-02	9,19E-04
7,45E-02	1,51E-04



Inverter Switch Characteristics

figure 5. IGBT

Gate voltage vs gate charge

$V_{GE} = f(Q_G)$

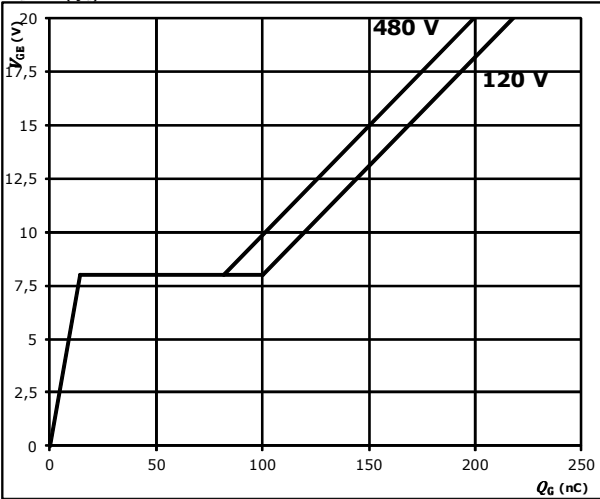

$I_C = 30$ A

figure 6. IGBT

Safe operating area

$I_C = f(V_{CE})$

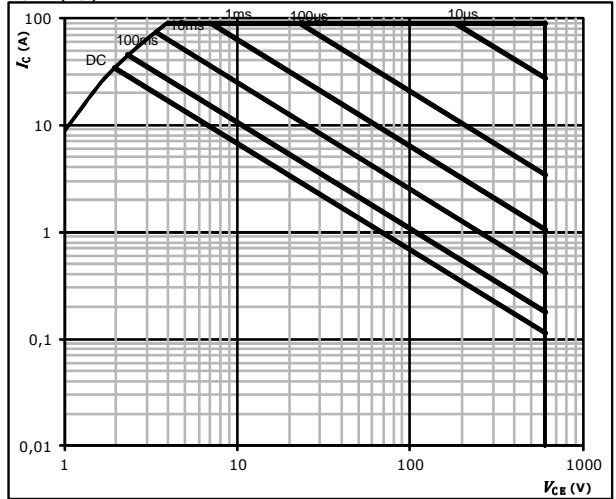

$D =$ single pulse
 $T_s = 80$ °C
 $V_{GE} = \pm 15$ V
 $T_j = T_{jmax}$ °C

figure 7. IGBT

Short circuit duration as a function of V_{GE}

$t_{pSC} = f(V_{GE})$

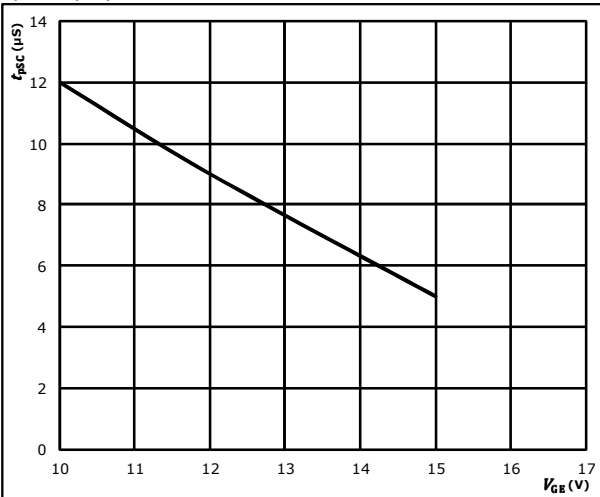

$V_{CE} = 400$ V
 $T_j \leq 150$ °C

figure 8. IGBT

Typical short circuit current as a function of V_{GE}

$I_{SC} = f(V_{GE})$

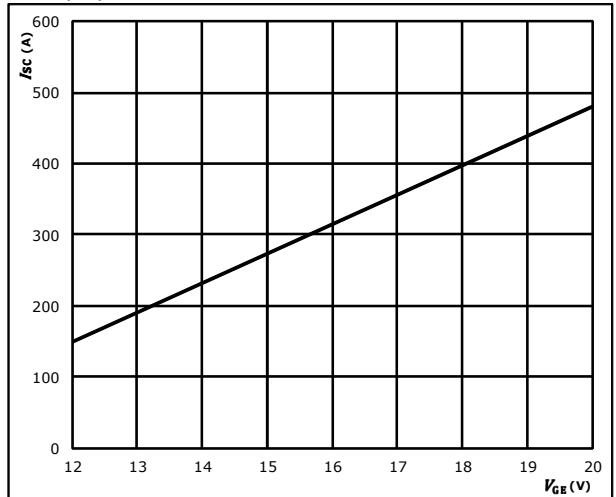

$V_{CE} \leq 400$ V
 $T_j \leq 150$ °C



Inverter Diode Characteristics

figure 1. FWD

Typical forward characteristics

$$I_F = f(V_F)$$

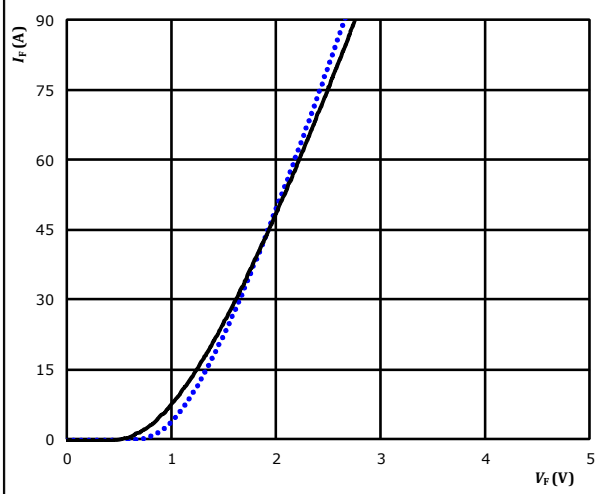

$t_p = 250 \mu s$ $T_j: 25 \text{ }^\circ\text{C}$ (blue dotted line) $125 \text{ }^\circ\text{C}$ (black solid line)

figure 2. FWD

Transient thermal impedance as a function of pulse width

$$Z_{th(j-s)} = f(t_p)$$

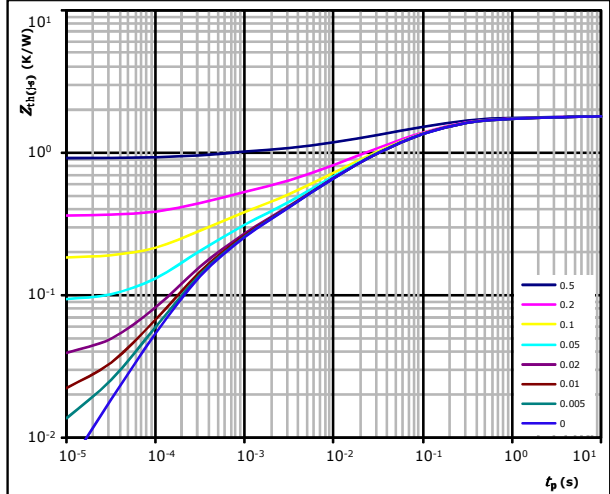

$D = t_p / T$
 $R_{th(j-s)} = 1,80 \text{ K/W}$
 FWD thermal model values

$R \text{ (K/W)}$	$\tau \text{ (s)}$
7,95E-02	3,72E+00
2,06E-01	4,02E-01
7,04E-01	8,35E-02
4,39E-01	1,56E-02
2,12E-01	2,93E-03
1,68E-01	3,31E-04

Thermistor Characteristics

Thermistor typical temperature characteristic

Typical NTC characteristic
as a function of temperature

$$R_T = f(T)$$

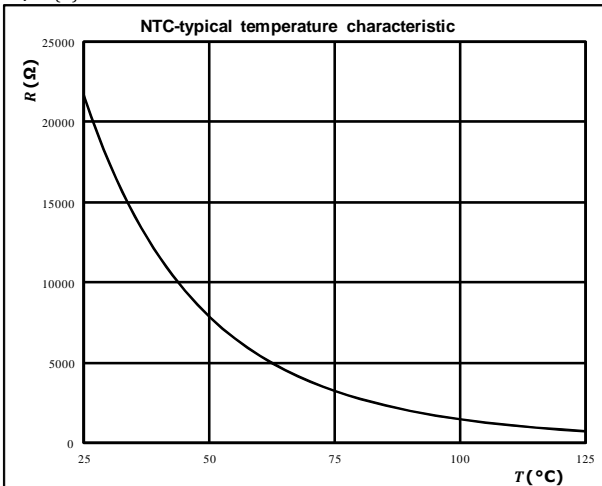



Switching Characteristics

figure 1. IGBT

Typical switching energy losses as a function of collector current

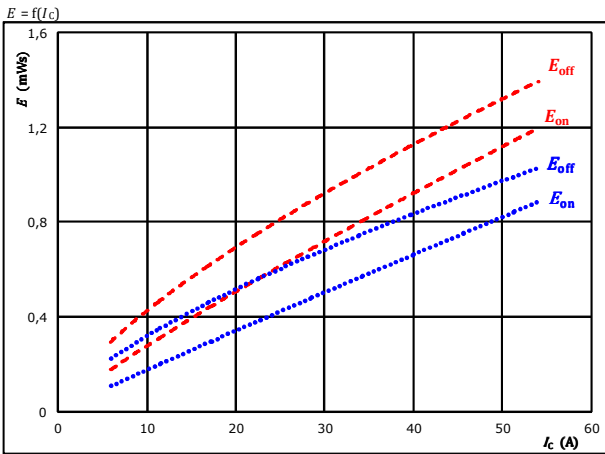

With an inductive load at
 $V_{CE} = 300$ V
 $V_{GE} = \pm 15$ V
 $R_{gon} = 16$ Ω
 $R_{goff} = 16$ Ω
 $T_j: 25$ °C (blue dotted)
 150 °C (red dashed)

figure 2. IGBT

Typical switching energy losses as a function of gate resistor

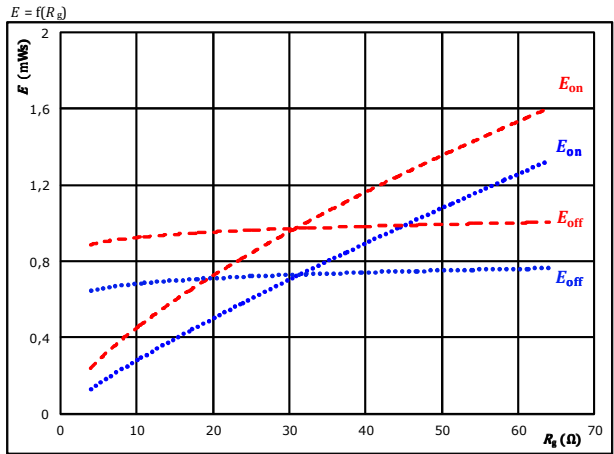

With an inductive load at
 $V_{CE} = 300$ V
 $V_{GE} = \pm 15$ V
 $I_C = 30$ A
 $T_j: 25$ °C (blue dotted)
 150 °C (red dashed)

figure 3. FWD

Typical reverse recovered energy loss as a function of collector current

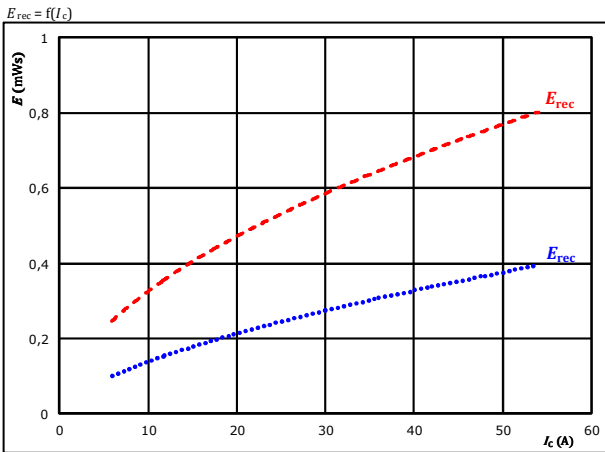

With an inductive load at
 $V_{CE} = 300$ V
 $V_{GE} = \pm 15$ V
 $R_{gon} = 16$ Ω
 $T_j: 25$ °C (blue dotted)
 150 °C (red dashed)

figure 4. FWD

Typical reverse recovered energy loss as a function of gate resistor

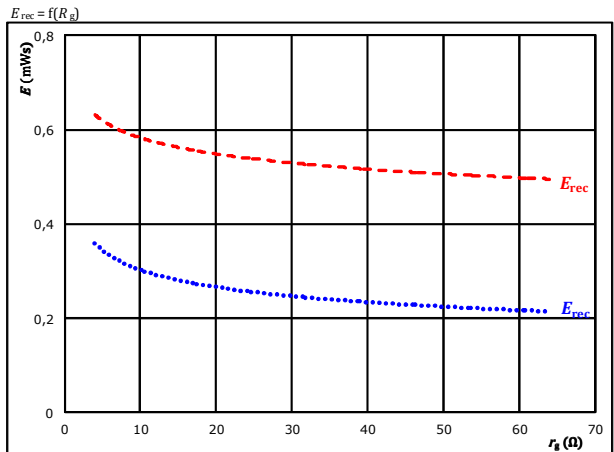

With an inductive load at
 $V_{CE} = 300$ V
 $V_{GE} = \pm 15$ V
 $I_C = 30$ A
 $T_j: 25$ °C (blue dotted)
 150 °C (red dashed)



Switching Characteristics

figure 5. IGBT

Typical switching times as a function of collector current

$$t = f(I_C)$$

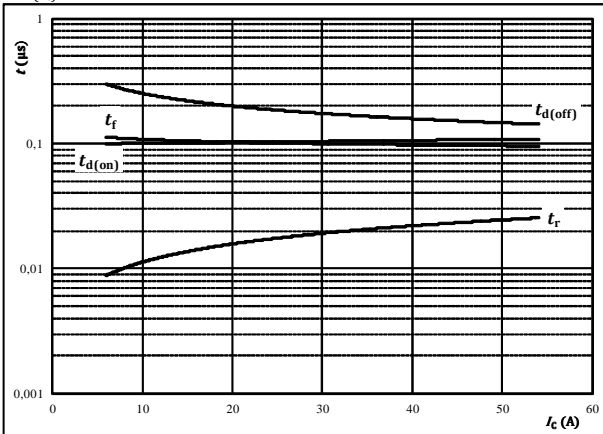

With an inductive load at

$T_j =$	150	$^{\circ}C$
$V_{CE} =$	300	V
$V_{GE} =$	± 15	V
$R_{gon} =$	16	Ω
$R_{goff} =$	16	Ω

figure 6. IGBT

Typical switching times as a function of gate resistor

$$t = f(R_g)$$

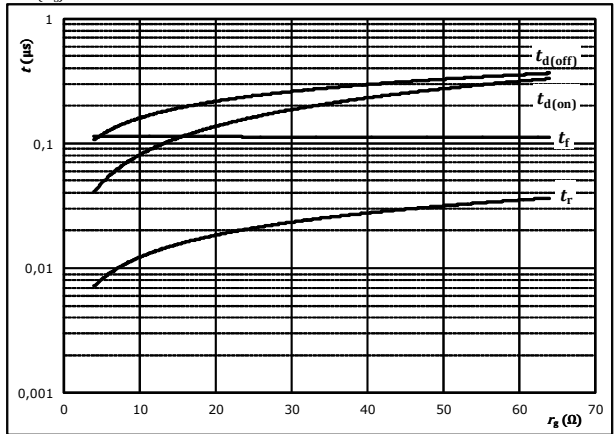

With an inductive load at

$T_j =$	150	$^{\circ}C$
$V_{CE} =$	300	V
$V_{GE} =$	± 15	V
$I_C =$	30	A

figure 7. FWD

Typical reverse recovery time as a function of collector current

$$t_{rr} = f(I_C)$$

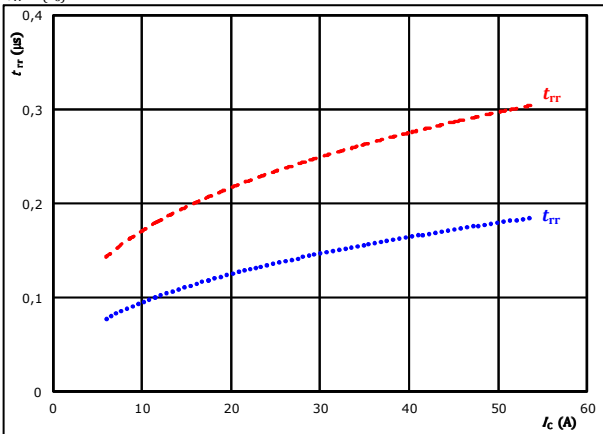

At	$V_{CE} =$	300	V	$T_j =$	25 $^{\circ}C$
	$V_{GE} =$	± 15	V		150 $^{\circ}C$	-----
	$R_{gon} =$	16	Ω			

figure 8. FWD

Typical reverse recovery time as a function of IGBT turn on gate resistor

$$t_{rr} = f(R_{gon})$$

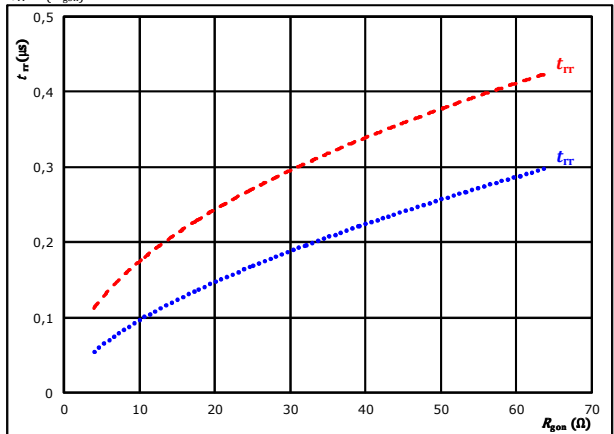

At	$V_{CE} =$	300	V	$T_j =$	25 $^{\circ}C$
	$V_{GE} =$	± 15	V		150 $^{\circ}C$	-----
	$I_C =$	30	A			



Switching Characteristics

figure 9. FWD

Typical recovered charge as a function of collector current

$$Q_r = f(I_c)$$

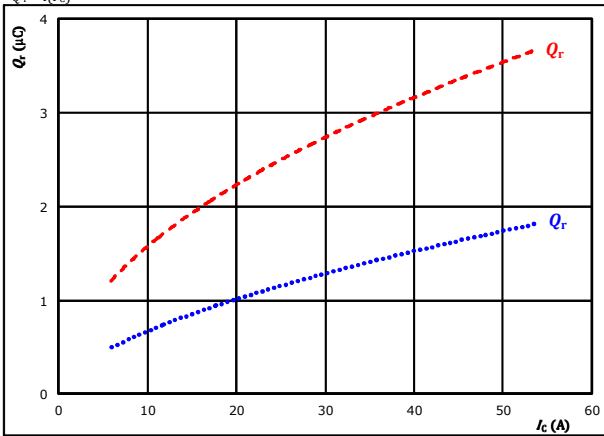

At $V_{CE} = 300$ V
 $V_{GE} = \pm 15$ V
 $R_{ggn} = 16$ Ω
 $T_j = 25$ °C (blue dotted line)
 $T_j = 150$ °C (red dashed line)

figure 10. FWD

Typical recovered charge as a function of IGBT turn on gate resistor

$$Q_r = f(R_{ggn})$$

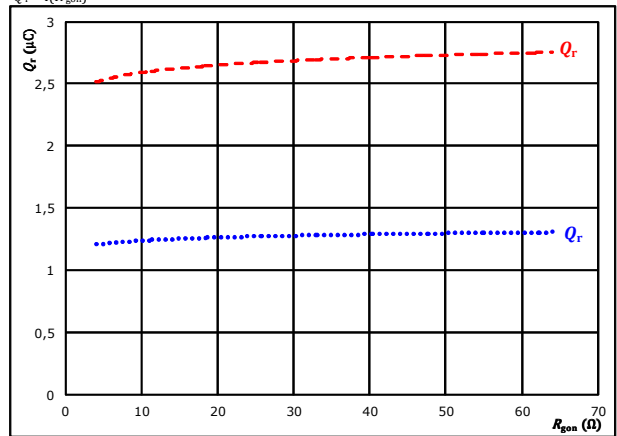

At $V_{CE} = 300$ V
 $V_{GE} = \pm 15$ V
 $I_c = 30$ A
 $T_j = 25$ °C (blue dotted line)
 $T_j = 150$ °C (red dashed line)

figure 11. FWD

Typical peak reverse recovery current as a function of collector current

$$I_{RM} = f(I_c)$$

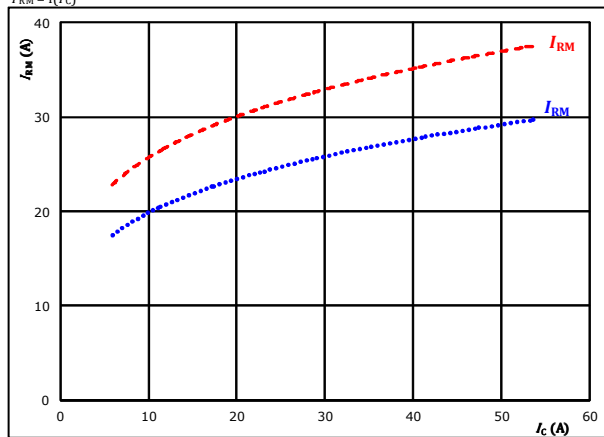

At $V_{CE} = 300$ V
 $V_{GE} = \pm 15$ V
 $R_{ggn} = 16$ Ω
 $T_j = 25$ °C (blue dotted line)
 $T_j = 150$ °C (red dashed line)

figure 12. FWD

Typical peak reverse recovery current as a function of IGBT turn on gate resistor

$$I_{RM} = f(R_{ggn})$$

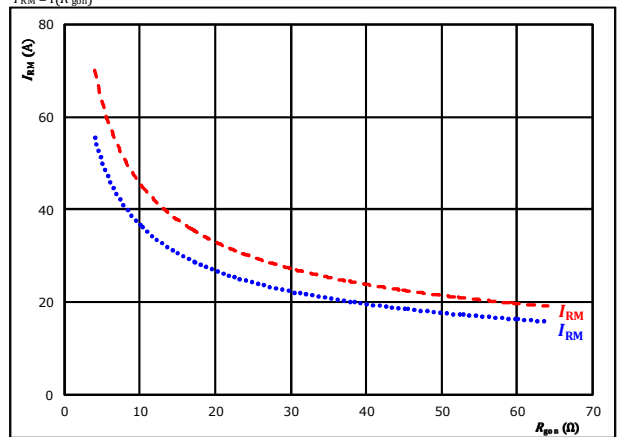

At $V_{CE} = 300$ V
 $V_{GE} = \pm 15$ V
 $I_c = 30$ A
 $T_j = 25$ °C (blue dotted line)
 $T_j = 150$ °C (red dashed line)



Switching Characteristics

figure 13. FWD

Typical rate of fall of forward and reverse recovery current as a function of collector current
 $di_f/dt, di_{rr}/dt = f(I_c)$

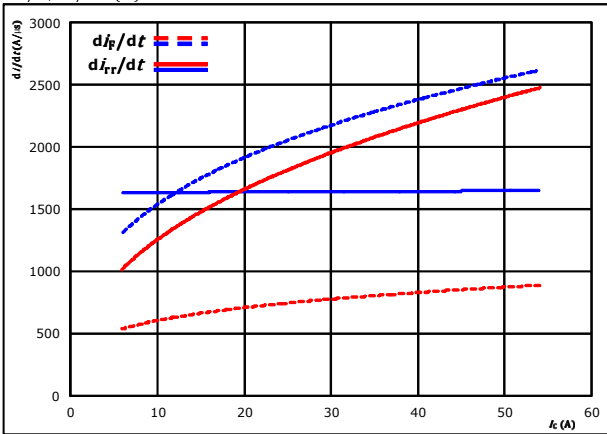

At $V_{CE} = 300$ V $T_j = 25$ °C (dotted blue)
 $V_{GE} = \pm 15$ V $T_j = 150$ °C (dashed red)
 $R_{gon} = 16$ Ω

figure 14. FWD

Typical rate of fall of forward and reverse recovery current as a function of IGBT turn on gate resistor
 $di_f/dt, di_{rr}/dt = f(R_{gon})$

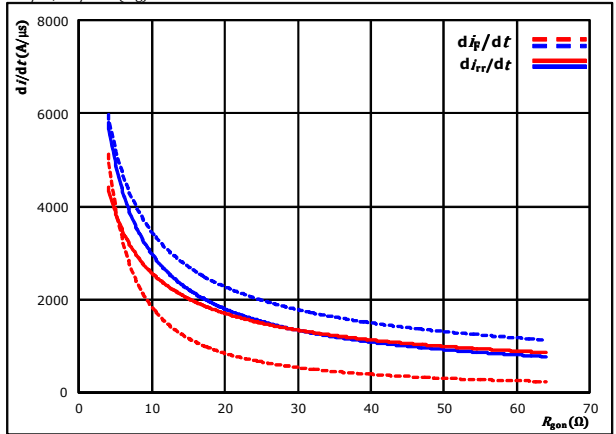

At $V_{CE} = 300$ V $T_j = 25$ °C (dotted blue)
 $V_{GE} = \pm 15$ V $T_j = 150$ °C (dashed red)
 $I_c = 30$ A

figure 15. IGBT

Reverse bias safe operating area
 $I_c = f(V_{ce})$

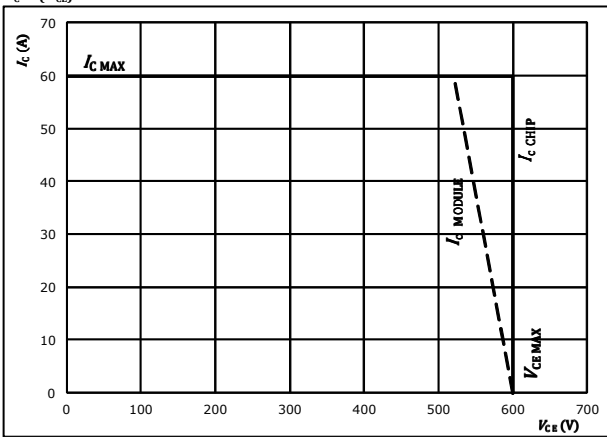

At $T_j = 175$ °C
 $R_{gon} = 16$ Ω
 $R_{goff} = 16$ Ω



Switching Characteristics

General conditions

T_j	=	150 °C
R_{gon}	=	16 Ω
R_{goff}	=	16 Ω

figure 1. IGBT

Turn-off Switching Waveforms & definition of t_{doff} , t_{Eoff} (t_{Eoff} = integrating time for E_{off})

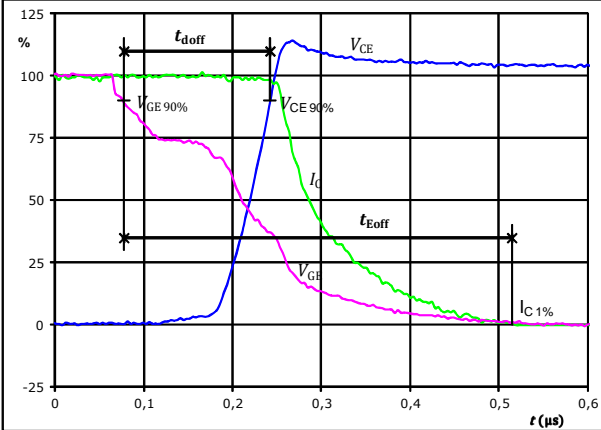

$V_{GE}(0\%)$	=	-15	V
$V_{GE}(100\%)$	=	15	V
$V_C(100\%)$	=	300	V
$I_C(100\%)$	=	30	A
t_{doff}	=	0,171	μs
t_{Eoff}	=	0,437	μs

figure 3. IGBT

Turn-off Switching Waveforms & definition of t_f

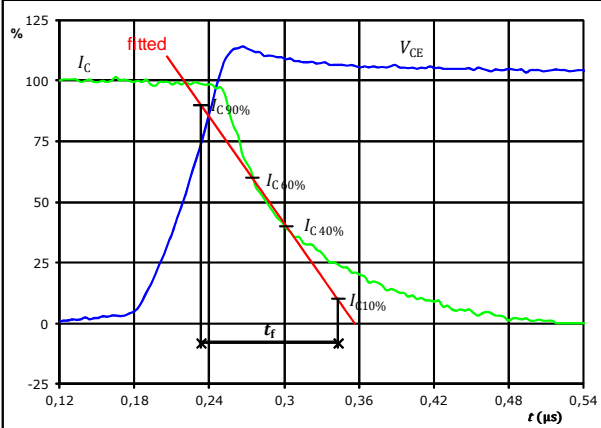

$V_C(100\%)$	=	300	V
$I_C(100\%)$	=	30	A
t_f	=	0,112	μs

figure 2. IGBT

Turn-on Switching Waveforms & definition of t_{don} , t_{Eon} (t_{Eon} = integrating time for E_{on})

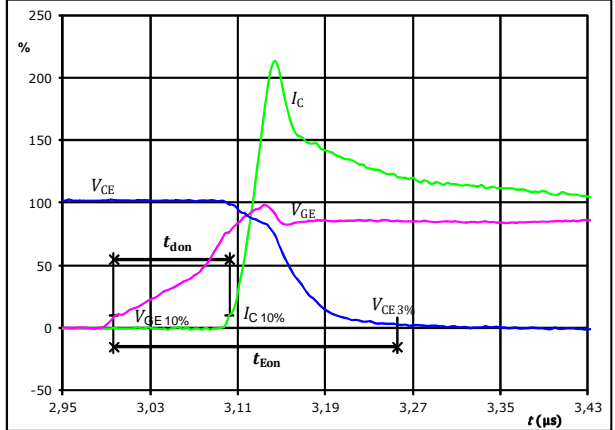

$V_{GE}(0\%)$	=	-15	V
$V_{GE}(100\%)$	=	15	V
$V_C(100\%)$	=	300	V
$I_C(100\%)$	=	30	A
t_{don}	=	0,104	μs
t_{Eon}	=	0,259	μs

figure 4. IGBT

Turn-on Switching Waveforms & definition of t_r

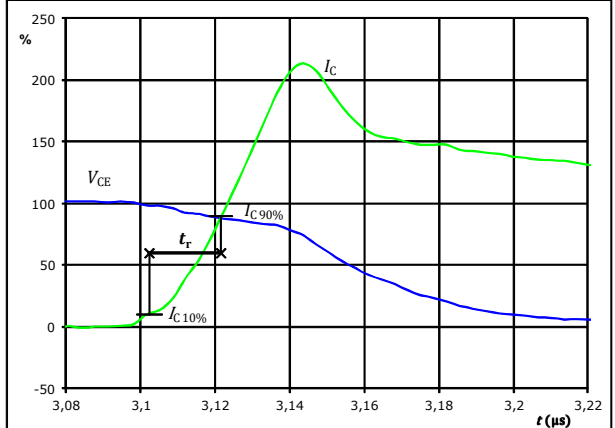

$V_C(100\%)$	=	300	V
$I_C(100\%)$	=	30	A
t_r	=	0,020	μs



Vincotech

Switching Characteristics

figure 5. IGBT

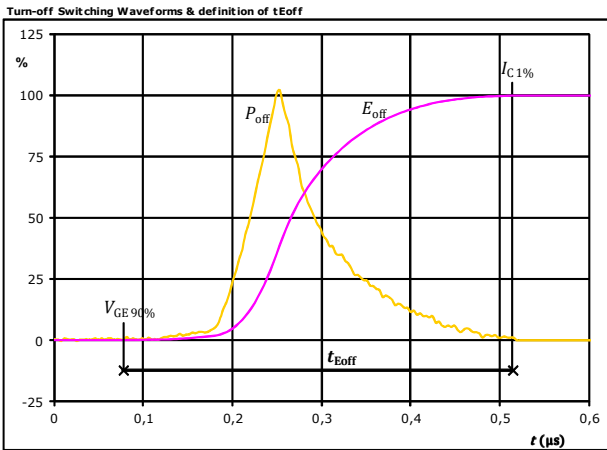

$P_{off}(100\%) = 9,01$ kW
 $E_{off}(100\%) = 0,91$ mJ
 $t_{Eoff} = 0,44$ µs

figure 6. IGBT

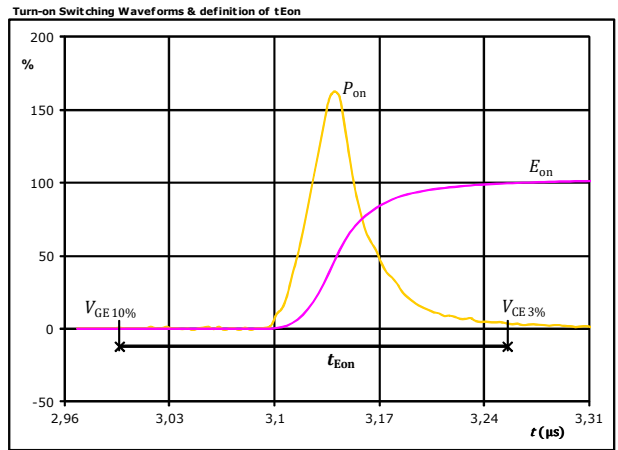

$P_{on}(100\%) = 9,01$ kW
 $E_{on}(100\%) = 0,67$ mJ
 $t_{Eon} = 0,26$ µs

figure 7. FWD

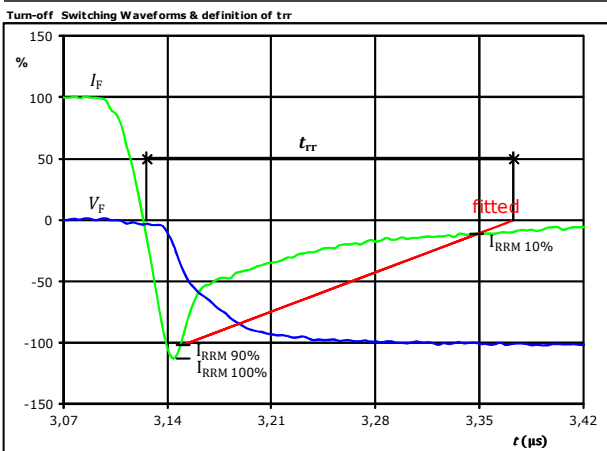

$V_F(100\%) = 300$ V
 $I_F(100\%) = 30$ A
 $I_{RRM}(100\%) = -34$ A
 $t_{rr} = 0,253$ µs



Vincotech

Switching Characteristics

figure 8. FWD

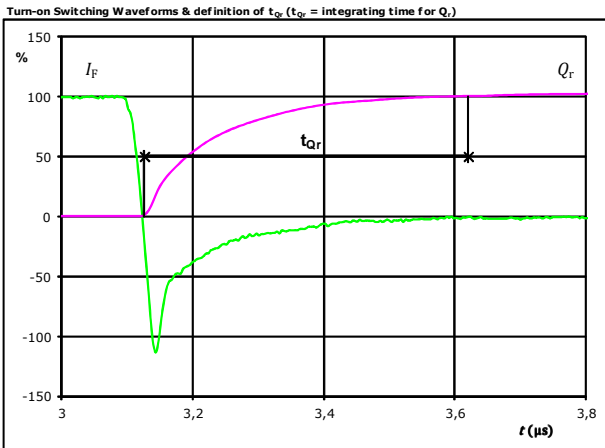

I_F (100%) =	30	A
Q_r (100%) =	2,65	μC
t_{Qr} =	0,49	μs

figure 9. FWD

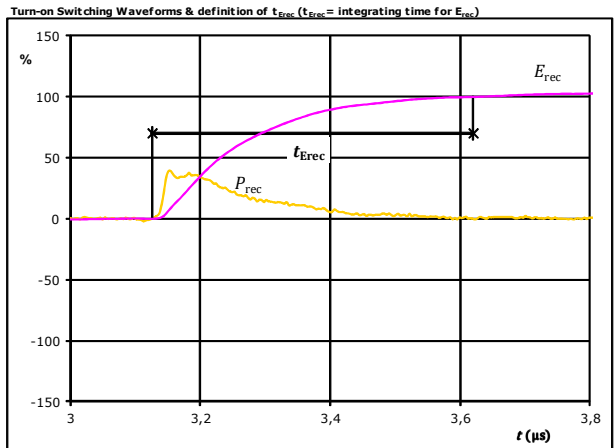

P_{rec} (100%) =	9,01	kW
E_{rec} (100%) =	0,57	mJ
t_{Erec} =	0,49	μs



Vincotech

Ordering Code & Marking																																
Version			Ordering Code																													
without thermal paste 17mm housing with solder pins			10-0B066PA030SB-M996F09																													
<table border="1"> <thead> <tr> <th rowspan="2">Text</th> <th colspan="2">Name</th> <th>Date code</th> <th>UL & VIN</th> <th>Lot</th> <th>Serial</th> </tr> <tr> <td colspan="2">NN-NNNNNNNNNNNNNN-TTTTTWW</td> <td>WWYY</td> <td>UL VIN</td> <td>LLLLL</td> <td>SSSS</td> </tr> </thead> <tbody> <tr> <td rowspan="2">Datamatrix</td> <th>Type&Ver</th> <th>Lot number</th> <th>Serial</th> <th>Date code</th> <td></td> <td></td> </tr> <tr> <td>TTTTTTTV</td> <td>LLLLL</td> <td>SSSS</td> <td>WWYY</td> <td></td> <td></td> </tr> </tbody> </table>							Text	Name		Date code	UL & VIN	Lot	Serial	NN-NNNNNNNNNNNNNN-TTTTTWW		WWYY	UL VIN	LLLLL	SSSS	Datamatrix	Type&Ver	Lot number	Serial	Date code			TTTTTTTV	LLLLL	SSSS	WWYY		
Text	Name		Date code	UL & VIN	Lot	Serial																										
	NN-NNNNNNNNNNNNNN-TTTTTWW		WWYY	UL VIN	LLLLL	SSSS																										
Datamatrix	Type&Ver	Lot number	Serial	Date code																												
	TTTTTTTV	LLLLL	SSSS	WWYY																												

Pin table [mm]			
Pin	X	Y	Function
1	27,8	0	G6
2	24,9	0	E6
3	19,1	0	G5
4	16,2	0	E5
5	11,6	0	NTC2
6	7,6	0	NTC1
7	2,9	0	E4
8	0	0	G4
9	0	13,7	U
10	2,9	13,7	G1
11	8,8	13,7	DC+
12	14,6	13,7	V
13	17,5	13,7	G2
14	24,9	13,7	G3
15	27,8	13,7	W

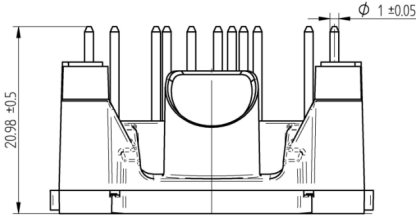
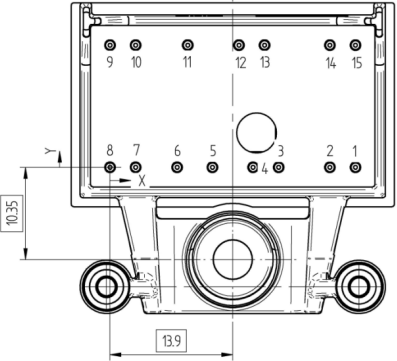
Tolerance of pinpositions: ±0,5mm at the end of pins
Dimension of coordinate axis is only offset without tolerance
PCB cutouts and holes see in handling instruction document



Vincotech

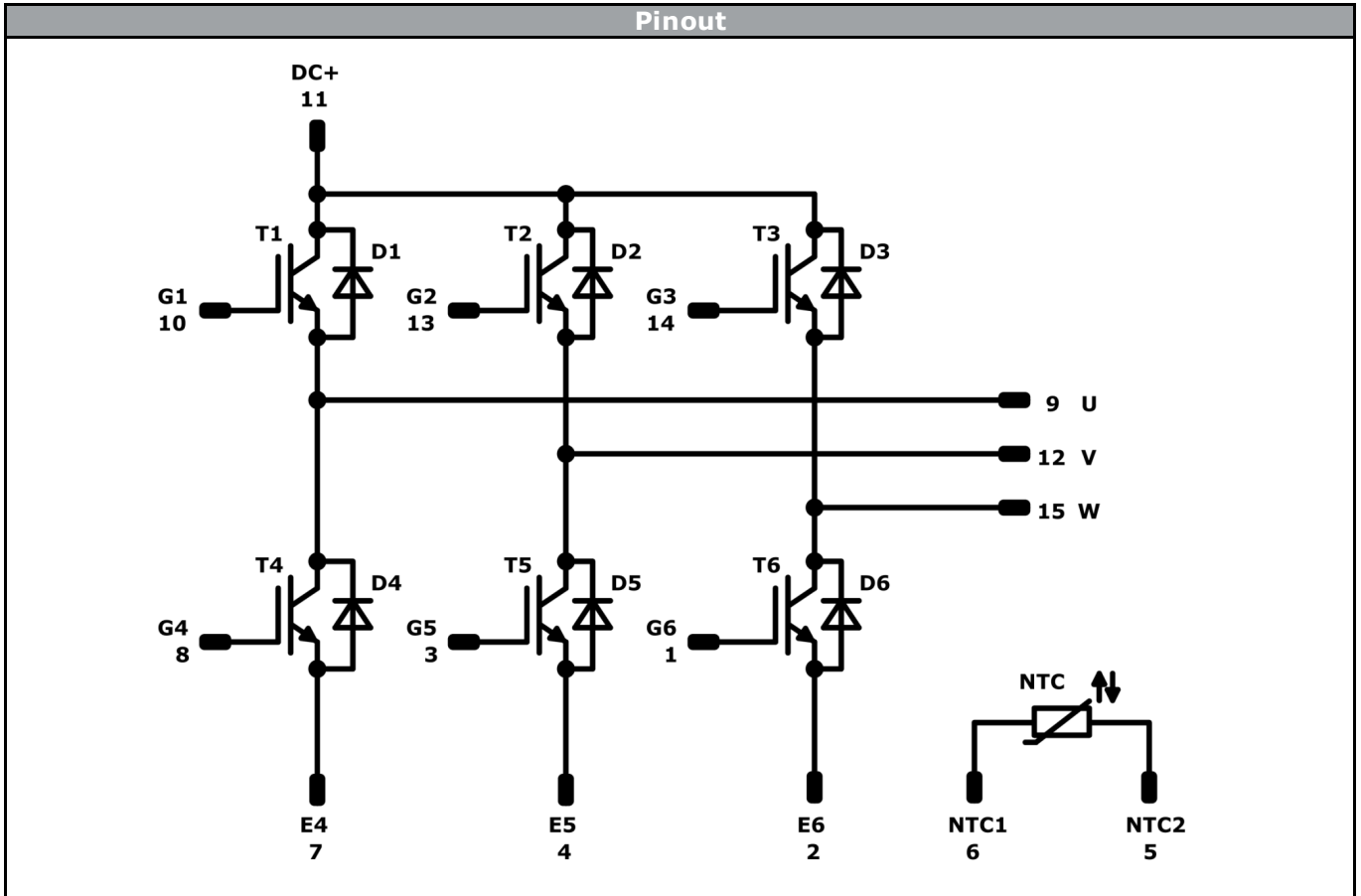

Identification					
ID	Component	Voltage	Current	Function	Comment
T1-T6	IGBT	600 V	30 A	Inverter Switch	
D1-D6	FWD	600 V	30 A	Inverter Diode	
NTC	Thermistor			Thermistor	



Vincotech

Packaging instruction			
Standard packaging quantity (SPQ) 160	>SPQ	Standard	<SPQ Sample

Handling instruction
Handling instructions for <i>flow0</i> B packages see vincotech.com website.

Package data
Package data for <i>flow0</i> B packages see vincotech.com website.

UL recognition and file number
This device is certified according to UL 1557 standard, UL file number E192116. For more information see vincotech.com website. 

Document No.:	Date:	Modification:	Pages
10-0B066PA030SB-M996F09-D3-14	23 Jun. 2017		

DISCLAIMER

The information, specifications, procedures, methods and recommendations herein (together "information") are presented by Vincotech to reader in good faith, are believed to be accurate and reliable, but may well be incomplete and/or not applicable to all conditions or situations that may exist or occur. Vincotech reserves the right to make any changes without further notice to any products to improve reliability, function or design. No representation, guarantee or warranty is made to reader as to the accuracy, reliability or completeness of said information or that the application or use of any of the same will avoid hazards, accidents, losses, damages or injury of any kind to persons or property or that the same will not infringe third parties rights or give desired results. It is reader's sole responsibility to test and determine the suitability of the information and the product for reader's intended use.

LIFE SUPPORT POLICY

Vincotech products are not authorised for use as critical components in life support devices or systems without the express written approval of Vincotech.

As used herein:

1. Life support devices or systems are devices or systems which, (a) are intended for surgical implant into the body, or (b) support or sustain life, or (c) whose failure to perform when properly used in accordance with instructions for use provided in labelling can be reasonably expected to result in significant injury to the user.
2. A critical component is any component of a life support device or system whose failure to perform can be reasonably expected to cause the failure of the life support device or system, or to affect its safety or effectiveness.