

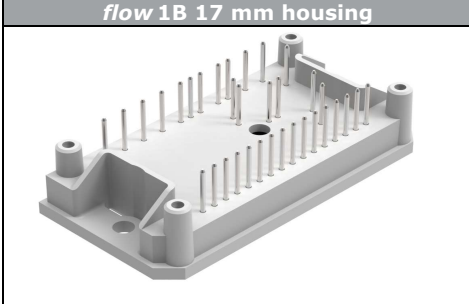
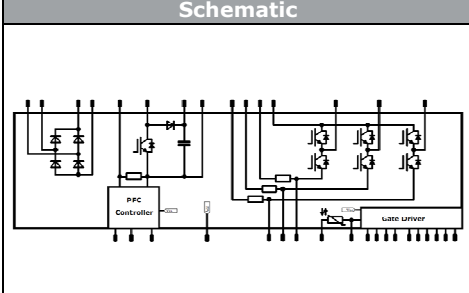

<i>flow</i> IPM 1B	600 V / 10 A
<div style="background-color: #eee; padding: 2px; margin-bottom: 5px;">Features</div> <ul style="list-style-type: none"> CIP-topology (converter + inverter + PFC) Optimized for PFC frequencies up to 150 kHz * Integrated PFC controller circuit with programmable DC output voltage and PWM frequency Inverter gate drive including bootstrap circuit for high side power supply Over current and short circuit protection Open emitter or emitter shunts Temperature sensor 	<div style="background-color: #eee; padding: 2px; margin-bottom: 5px;">flow 1B 17 mm housing</div> 
<div style="background-color: #eee; padding: 2px; margin-bottom: 5px;">Target Applications</div> <ul style="list-style-type: none"> Embedded Drives Industrial Drives 	<div style="background-color: #eee; padding: 2px; margin-bottom: 5px;">Schematic</div> 
<div style="background-color: #eee; padding: 2px; margin-bottom: 5px;">Types</div> <ul style="list-style-type: none"> 20-1B06IPB010RC02-L815A49 20-1B06IPB010RC02-L815A49-/3/ 	

Maximum Ratings

$T_j=25^{\circ}\text{C}$, unless otherwise specified

Parameter	Symbol	Condition	Value	Unit
Input Rectifier Diode				
Repetitive peak reverse voltage	V_{RRM}		1600	V
DC forward current	I_{FAV}	$T_j = T_{jmax}$ $T_s = 80^{\circ}\text{C}$	13	A
Surge (non-repetitive) forward current	I_{FSM}	$t_p = 10\text{ ms}$ 50 Hz half sine wave $T_j = 150^{\circ}\text{C}$	130	A
I^2t -value	I^2t		80	A^2s
Power dissipation	P_{tot}	$T_j = T_{jmax}$ $T_s = 80^{\circ}\text{C}$	15	W
Maximum Junction Temperature	T_{jmax}		150	$^{\circ}\text{C}$

**Maximum Ratings** $T_j=25^{\circ}\text{C}$, unless otherwise specified

Parameter	Symbol	Condition	Value	Unit
-----------	--------	-----------	-------	------

PFC Switch

Collector-emitter breakdown voltage	V_{CE}		650	V
DC collector current	I_C	$T_j = T_{jmax}$ $T_s = 80^{\circ}\text{C}$	12	A
Repetitive peak collector current	I_{CRM}	t_p limited by T_{jmax}	90	A
Turn off safe operating area		$V_{CE} \leq 650\text{ V}$, $T_j \leq T_{op\ max}$	90	A
Power dissipation	P_{tot}	$T_j = T_{jmax}$ $T_s = 80^{\circ}\text{C}$	19	W
Gate-emitter peak voltage	V_{GE}		± 20	V
Maximum Junction Temperature	T_{jmax}		175	$^{\circ}\text{C}$

* The integrated PFC controller operating at switching frequencies > 100 kHz might show some limitations depending on the application. Please contact our sales representative for further details.

PFC Inverse Diode

Peak Repetitive Reverse Voltage	V_{RRM}		650	V
DC forward current	I_F	$T_j = T_{jmax}$ $T_s = 80^{\circ}\text{C}$	5	A
Repetitive peak forward current	I_{FRM}	t_p limited by T_{jmax}	12	A
Power dissipation	P_{tot}	$T_j = T_{jmax}$ $T_s = 80^{\circ}\text{C}$	10	W
Maximum Junction Temperature	T_{jmax}		175	$^{\circ}\text{C}$

PFC Diode

Peak Repetitive Reverse Voltage	V_{RRM}		650	V
DC forward current	I_F	$T_j = T_{jmax}$ $T_s = 80^{\circ}\text{C}$	7	A
Repetitive peak forward current	I_{FRM}	t_p limited by T_{jmax}	35	A
Power dissipation	P_{tot}	$T_j = T_{jmax}$ $T_s = 80^{\circ}\text{C}$	11	W
Maximum Junction Temperature	T_{jmax}		175	$^{\circ}\text{C}$

**Maximum Ratings** $T_j=25^{\circ}\text{C}$, unless otherwise specified

Parameter	Symbol	Condition	Value	Unit
-----------	--------	-----------	-------	------

Inverter Switch

Collector-emitter breakdown voltage	V_{CE}		600	V
DC collector current	I_C	$T_j = T_{jmax}$ $T_s = 80^{\circ}\text{C}$	8	A
Repetitive peak collector current	I_{CRM}	t_p limited by T_{jmax}	30	A
Turn off safe operating area		$V_{CE} \leq 600\text{ V}$, $T_j \leq 150^{\circ}\text{C}$	20	A
Power dissipation	P_{tot}	$T_j = T_{jmax}$ $T_s = 80^{\circ}\text{C}$	16	W
Gate-emitter peak voltage	V_{GE}		± 20	V
Short circuit ratings	t_{SC} V_{CC}	$T_j \leq 150^{\circ}\text{C}$ $V_{GE} = 15\text{ V}$	5 400	μs V
Maximum Junction Temperature	T_{jmax}		175	$^{\circ}\text{C}$

Inverter Diode

Peak Repetitive Reverse Voltage	V_{RRM}		600	V
DC forward current	I_F	$T_j = T_{jmax}$ $T_s = 80^{\circ}\text{C}$	8	A
Power dissipation	P_{tot}	$T_j = T_{jmax}$ $T_s = 80^{\circ}\text{C}$	14	W
Maximum Junction Temperature	T_{jmax}		175	$^{\circ}\text{C}$

PFC Shunt

DC forward current	I_F	$T_c = 25^{\circ}\text{C}$	10	A
Power dissipation	P_{tot}	$T_c = 25^{\circ}\text{C}$	4	W

PFC Controller*

VCC supply voltage	V_{CC}	V_{CC} common with gate driver IC	26	V
Vsense voltage	V_{VSENSE}		26	V
Vsense current	I_{VSENSE}		800	μA
FREQ pin voltage	V_{FREQ}		5,3	V
Maximum Junction Temperature	T_{jmax}		125	$^{\circ}\text{C}$

*For more information please contact VIN sales representative for the updated release of ICE3PCS02 datasheet

DC - Shunt

DC forward current	I_F		8	A
Power dissipation	P_{tot}		2	W

**Maximum Ratings** $T_j=25^{\circ}\text{C}$, unless otherwise specified

Parameter	Symbol	Condition	Value	Unit
-----------	--------	-----------	-------	------

DC link Capacitor

Maximum DC voltage	V_{MAX}	$T_c = 25^{\circ}\text{C}$	500	V
--------------------	-----------	----------------------------	-----	---

Gate Driver*

Supply voltage	U_{CC}		20	V
Input voltage (LIN, HIN, EN)	U_{IN}		10	V
Output voltage (FAULT)	U_{OUT}		VCC+0,5	V

* for more information see infineon's datasheet 6ED003L02-F2

Thermal Properties

Storage temperature	T_{stg}		-40...+125	$^{\circ}\text{C}$
Operation temperature under switching con	T_{op}		-40...+(Tjmax - 25)	$^{\circ}\text{C}$

Isolation Properties

Isolation voltage	V_{is}	$t = 2\text{ s}$ DC voltage	4000	V
Creepage distance			min 12,7	mm
Clearance			min 12,7	mm
Comparative tracking index	CTI		>200	



Characteristic Values

Parameter	Symbol	Conditions					Value			Unit				
		V_{GE} [V]	V_{GS} [V]	V_F [V]	V_{CE} [V]	V_{DS} [V]	I_C [A]	I_F [A]	I_D [A]		T_j [°C]	Min	Typ	Max
Input Rectifier Diode														
Forward voltage	V_F					7	25	125			1,04	0,97		V
Threshold voltage (for power loss calc. only)	V_{to}					7	25	125			0,87	0,74		V
Slope resistance (for power loss calc. only)	r_t					7	25	125			25	33		mΩ
Reverse current	I_r				1600		25					0,01		mA
Thermal resistance junction to sink	$R_{th(j-s)}$	phase-change material $\lambda = 3,4$ W/mK									4,56			K/W

PFC Switch														
Gate emitter threshold voltage	$V_{GE(th)}$	$V_{CE} = V_{GE}$				0,0003	25		3,3	4	4,7			V
Collector-emitter saturation voltage	V_{CEsat}		15			10	25	125		1,28	1,28	1,9		V
Collector-emitter cut-off	I_{CES}		0	650			25					0,04		mA
Turn-on delay time	$t_{d(on)}$		$U_{cc} = 15$ V	400	10		25			21			ns	
Rise time	t_r						125			25		6		
Turn-off delay time	$t_{d(off)}$						25			125		160		
Fall time	t_f						25			125		192		
Turn-on energy loss	E_{on}						25			125		2		
Turn-off energy loss	E_{off}						25			125		2		
Input capacitance	C_{ies}								2100					mWs
Output capacitance	C_{oss}	$f = 1$ MHz	0	25			25			45				pF
Reverse transfer capacitance	C_{rss}									7,7				
Thermal resistance junction to sink	$R_{th(j-s)}$	phase-change material $\lambda = 3,4$ W/mK								4,96				K/W

PFC Inverse Diode														
Diode forward voltage	V_F					6	25	125	1,23	1,73	0,97	2,15		V
Thermal resistance junction to sink	$R_{th(j-s)}$	phase-change material $\lambda = 3,4$ W/mK								9,56				K/W

PFC Diode														
Forward voltage	V_F					8	25	125		1,65	1,55	2,1		V
Reverse leakage current	I_{rm}			400		10	25					160		μA
Peak recovery current	I_{RRM}		$U_{cc} = 15$ V	400	10		25			3			ns	
Reverse recovery time	t_{rr}						125			25		16,7		
Reverse recovery charge	Q_{rr}						25			125		0,03		
Reverse recovered energy	E_{rec}						25			125		0,04		
Peak rate of fall of recovery current	$(di_{rr}/dt)_{max}$						25			125		0,0060		
							25			125		0,009		
Thermal resistance junction to sink	$R_{th(j-s)}$	phase-change material $\lambda = 3,4$ W/mK								9,02				K/W

PFC Shunt														
R_4 value	R									40				mΩ

Characteristic Values

Parameter	Symbol	Conditions					Value			Unit
		V_{GE} [V] V_{GS} [V]	V_r [V] V_{CE} [V] V_{DS} [V]	I_c [A] I_F [A] I_D [A]	T_j [°C]	Min	Typ	Max		
Inverter Switch										
Gate emitter threshold voltage	$V_{GE(th)}$	$V_{CE} = V_{GE}$			0,00017	25	4,4	5	5,6	V
Collector-emitter saturation voltage*	V_{CEsat}		15		10	25 125	1,7	2,20 2,32	2,95	v
Collector-emitter cut-off current incl. Diode	I_{CES}		0	600		25			0,1	mA
Gate-emitter leakage current	I_{GES}		20	0		25			120	nA
Integrated Gate resistor	R_{gint}							none		Ω
Turn-on delay time **	$t_{d(on)}$					25 125		582 631		ns
Rise time	t_r					25 125		20 25		
Turn-off delay time **	$t_{d(off)}$					25 125		837 950		
Fall time	t_f					25 125		16 22		
Turn-on energy loss	E_{on}					25 125		0,1950 0,3241		mWs
Turn-off energy loss	E_{off}					25 125		0,1611 0,2042		
Input capacitance	C_{ies}							655		pF
Output capacitance	C_{oss}	$f = 1$ MHz	0	25		25		37		
Reverse transfer capacitance	C_{rss}							22		
Gate charge	Q_G		15	480	10	25		64		nC
Thermal resistance junction to sink	$R_{th(j-s)}$	phase-change material $\lambda = 3,4$ W/mK						5,79		K/W
* chip data ** including gate driver										
Inverter Diode										
Diode forward voltage	V_F				10	25 125	1,5	2,23 2,18	2,85	v
Peak reverse recovery current	I_{RRM}					25 125		6 6		A
Reverse recovery time	t_{rr}					25 125		179 276		ns
Reverse recovered charge	Q_{rr}					25 125		0,3566 0,6738		μ C
Peak rate of fall of recovery current	$(di_{rr}/dt)_{max}$					25 125		181 46		A/ μ s
Reverse recovered energy	E_{rec}					25 125		0,0867 0,1610		mWs
Thermal resistance junction to sink	$R_{th(j-s)}$	phase-change material $\lambda = 3,4$ W/mK						6,66		K/W
DC - Shunt										
R_2 value	R					25		30		m Ω
DC link Capacitor										
C value	C							100		nF

Characteristic Values

Parameter	Symbol	Conditions					Value			Unit											
		V_{GE} [V]	V_{GS} [V]	V_r [V]	V_{CE} [V]	V_{DS} [V]	I_c [A]	I_F [A]	I_D [A]		T_j [°C]	Min	Typ	Max							
Gate Driver																					
Supply voltage	U_{CC}										13	15	17,5	V							
Quiescent Vcc supply current	I_{QCC}	$U_{LIN} = 0\text{ V}; U_{HIN} = 3,3\text{ V}$											1,3	2	mA						
Input voltage (LIN, HIN, EN)	U_{IN}												0	5	V						
Logic "0" input voltage (LIN, HIN)	U_{IH}												1,7	2,1		2,4					
Logic "1" input voltage (LIN, HIN)	U_{IL}	$U_{CC} = 15\text{ V}$											0,7	0,9		1,1					
Positive going threshold voltage (EN)	$U_{EN,TH+}$												1,9	2,1		2,3					
Negative going threshold voltage (EN)	$U_{EN,TH-}$												1,1	1,3		1,5					
Input clamp voltage (LIN, HIN, EN)	$U_{IN,CLAMP}$	$I_{IN} = 4\text{ mA}$											9	10,3		12					
ITRIP positive going threshold	$U_{TR,TH+}$												380	445	510	mV					
Input bias current LIN high	I_{LIN+}	$U_{LIN} = 3,3\text{ V}$					25							70	100	μ A					
Input bias current LIN low	I_{LIN-}	$U_{LIN} = 0\text{ V}$												110	200						
Input bias current HIN high	I_{HIN+}	$U_{HIN} = 3,3\text{ V}$												70	100						
Input bias current HIN low	I_{HIN-}	$U_{HIN} = 0\text{ V}$												110	120						
Input bias current EN high	I_{EN+}	$U_{HIN} = 3,3\text{ V}$												45	120						
Output voltage (FAULT)	U_{FLT}													0			U_{CC}	V			
Low on resistor of pull down trans. (FAULT)	$R_{ON,FLT}$	$U_{FAULT} = 0,5\text{ V}$												45,0	100	Ω					
Pulse width for ON or OFF	t_{IN}												1			μ s					
Turn-on propagation delay (LIN, HIN)	t_{ON}												400	530	800	ns					
Turn-off propagation delay (LIN, HIN)	t_{OFF}	$U_{LIN/HIN} = 0\text{ V or } 3,3\text{ V}$											360	490	760						
FAULT reset time	t_{RST}													4		ms					
Fixed deadtime between high and low side	t_{DT}	$U_{LIN/HIN} = 0\text{ V \& } 3,3\text{ V}$											150	310		ns					
PFC Controller																					
Supply voltage*	V_{CC}												15		26	V					
VCC turn-on threshold	V_{CCon}												11,5	12,0	12,9	V					
VCC turn-off threshold	V_{CCUVLO}												10,5	11,0	11,9	V					
Operating current with active GATE	I_{CCHG}	$C_L = 1\text{ nF}$												6,4	8,5	mA					
Operating current during standby	I_{CCsby}													3,5	4,7	mA					
PFC switching frequency	F_{SWnom}	Set with an internal resistor $R_{FREQ} = 91\text{ k}\Omega^{**}$												50		kHz					
PFC disable threshold	V_{disPFC}	pull Vsense higher than Vdis PFC to disable PFC operation												14		V					
DC link voltage	DC2+	Set with an internal resistor divider***					25							325		410	V				
DC link threshold (OVP1) low to high	$V_{OVP1L2H}$	relative to output voltage with VSENSE pin unconnected VSENSE pin voltage $V_{DCLink}/130$													108		%				
DC link threshold (OVP1) high to low	$V_{OVP1H2L}$																		100		%
Blanking time for OVP1	t_{OVP1}																		12		μ s
DC link threshold (OVP1) hysteresis	$V_{OVP1,HYS}$													6	8	11	%				
DC link threshold (OVP2) low to high	$V_{OVP2L2H}$													428	443	460	V				
DC link threshold (OVP2) high to low	$V_{OVP2H2L}$	relative to OVP2												92		%					
Blanking time for OVP2	t_{OVP2}													12		μ s					
*recommended supply voltage range: 15-18 V **switching frequency is settable by an external resistor between pins 14-16 (see figure on page24 for values) ***DC link voltage is settable by an external resistor between pins 14-15 (see figure on page24 for values)																					
Thermistor																					
Rated resistance	R												25		22000	Ω					
Deviation of R_{100}	$\Delta R/R$	$R_{100} = 1486\ \Omega$											100	-12	12	%					
Power dissipation	P												25		200	mW					
Power dissipation constant													25		2	mW/K					
B-value	$B_{(25/50)}$	Tol. $\pm 3\%$											25		3950	K					
B-value	$B_{(25/100)}$	Tol. $\pm 3\%$											25		3998	K					
Vincotech NTC Reference																B					



Output Inverter

figure 1. Output inverter IGBT

Typical output characteristics

$I_C = f(V_{CE})$

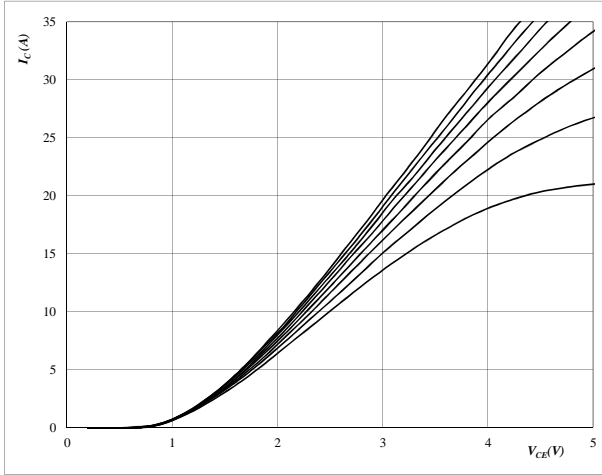

At

$t_p = 250 \mu s$
 $T_j = 25 \text{ }^\circ C$
 U_{CC} from 10 V to 17 V in steps of 1 V

figure 2. Output inverter IGBT

Typical output characteristics

$I_C = f(V_{CE})$

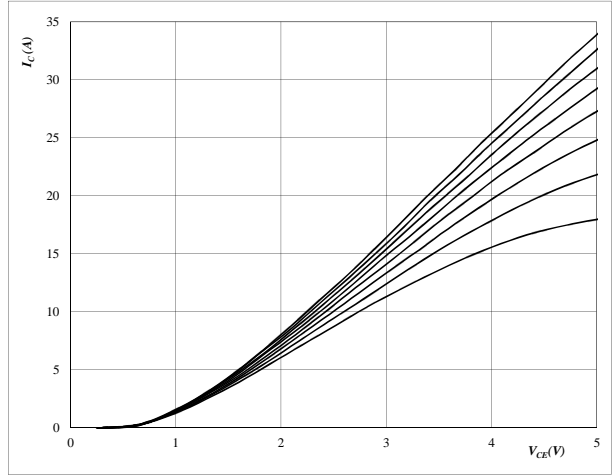

At

$t_p = 250 \mu s$
 $T_j = 125 \text{ }^\circ C$
 U_{CC} from 10 V to 17 V in steps of 1 V

figure 3. Output inverter FWD

Typical diode forward current as a function of forward voltage

$I_F = f(V_F)$

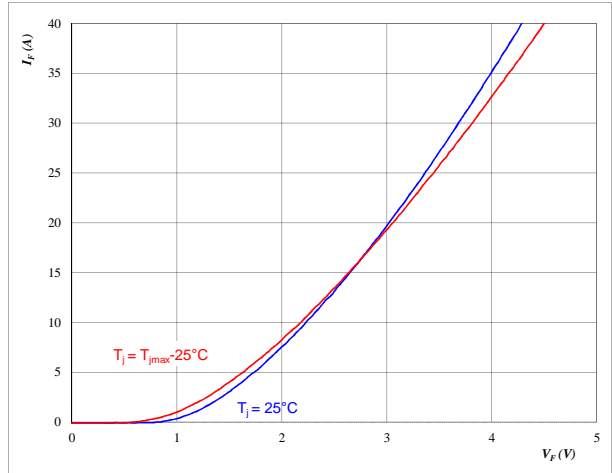

At

$t_p = 250 \mu s$



Output Inverter

figure 4. Output inverter IGBT

Typical switching energy losses as a function of collector current

$E = f(I_C)$

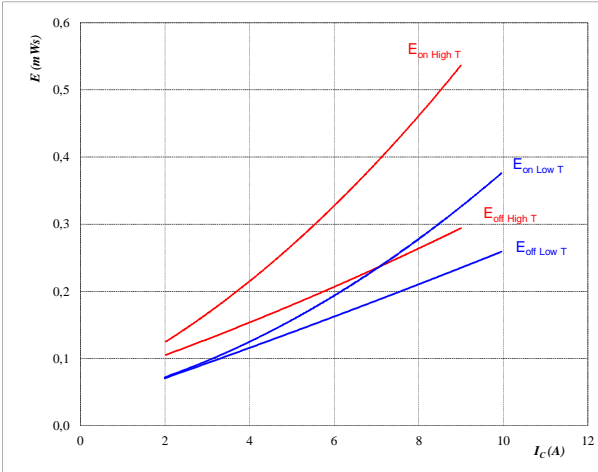

With an inductive load at

$T_j = 25/125 \text{ } ^\circ\text{C}$

$V_{CE} = 400 \text{ V}$

$U_{CC} = 15 \text{ V}$

figure 5. Output inverter FWD

Typical reverse recovery energy loss as a function of collector current

$E_{rec} = f(I_C)$

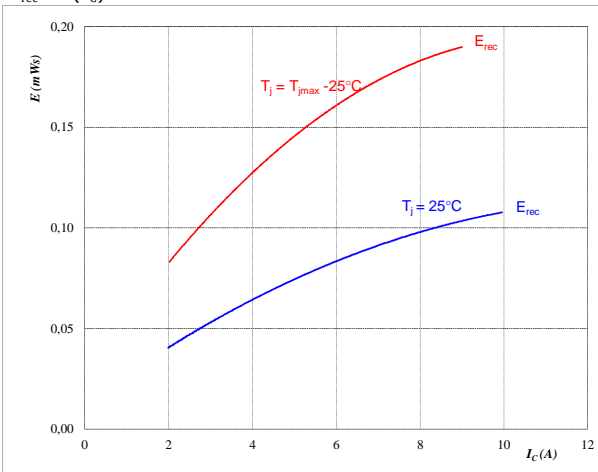

With an inductive load at

$T_j = 25/125 \text{ } ^\circ\text{C}$

$V_{CE} = 400 \text{ V}$

$U_{CC} = 15 \text{ V}$



Output Inverter

figure 6. Output inverter IGBT

Typical switching times as a function of collector current

$t = f(I_c)$

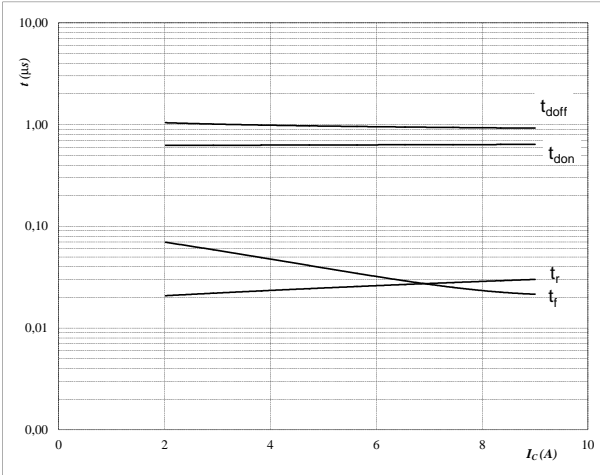

With an inductive load at

- $T_j = 125 \text{ } ^\circ\text{C}$
- $V_{CE} = 400 \text{ V}$
- $U_{CC} = 15 \text{ V}$

figure 7. Output inverter FWD

Typical reverse recovery time as a function of collector current

$t_{rr} = f(I_c)$

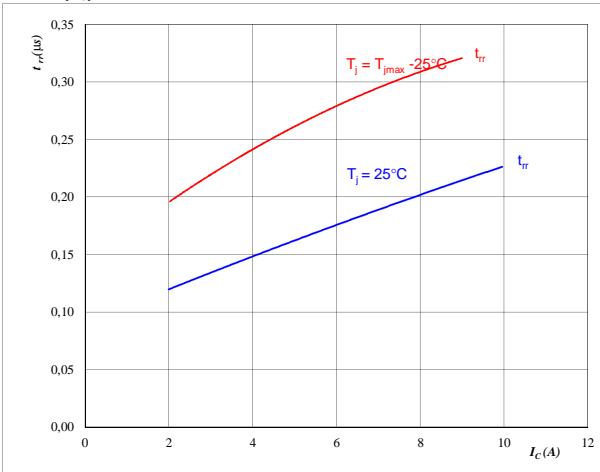

At

- $T_j = 25/125 \text{ } ^\circ\text{C}$
- $V_{CE} = 400 \text{ V}$
- $U_{CC} = 15 \text{ V}$



Output Inverter

figure 8. Output inverter FWD

Typical reverse recovery charge as a function of collector current

$Q_{rr} = f(I_c)$

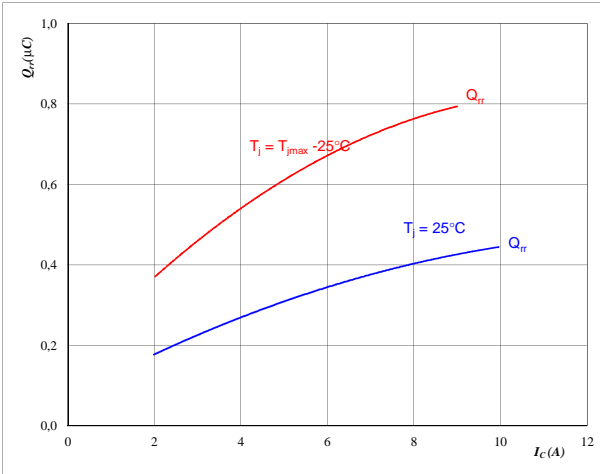

At

$T_j = 25/125 \text{ } ^\circ\text{C}$

$V_{CE} = 400 \text{ V}$

$U_{CC} = 15 \text{ V}$

figure 9. Output inverter FWD

Typical reverse recovery current as a function of collector current

$I_{RRM} = f(I_c)$

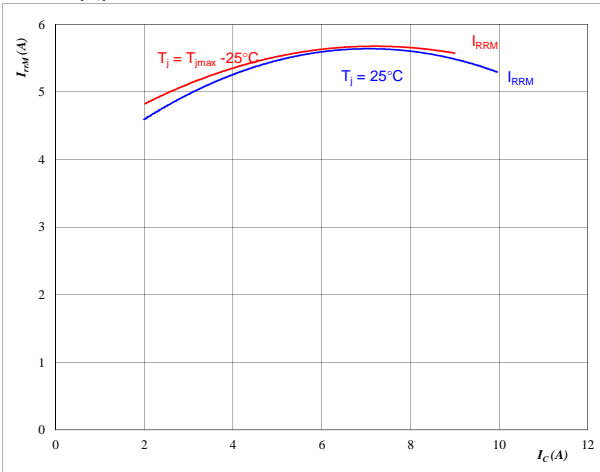

At

$T_j = 25/125 \text{ } ^\circ\text{C}$

$V_{CE} = 400 \text{ V}$

$U_{CC} = 15 \text{ V}$



Output Inverter

figure 10. Output inverter FWD

Typical rate of fall of forward and reverse recovery current as a function of collector current

$$dI_0/dt, dI_{rec}/dt = f(I_C)$$

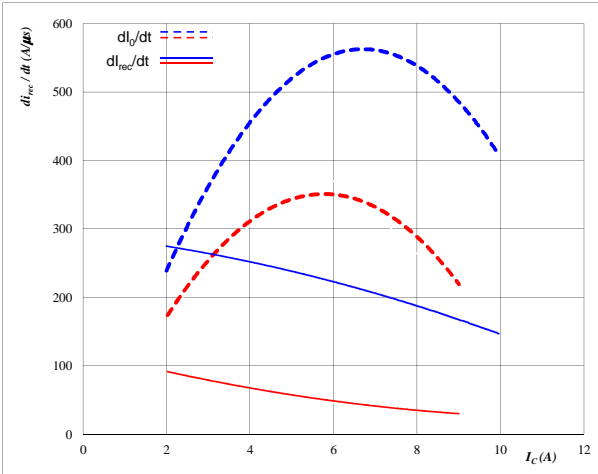

At

$T_j = 25/125 \text{ } ^\circ\text{C}$
 $V_{CE} = 400 \text{ V}$
 $U_{CC} = 15 \text{ V}$

figure 11. Output inverter IGBT

IGBT transient thermal impedance as a function of pulse width

$$Z_{th(j-s)} = f(t_p)$$

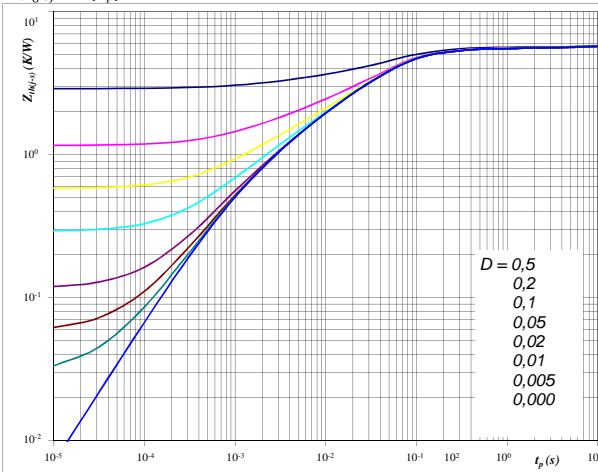

At

$D = t_p / T$
 $R_{th(j-s)} = 5,79 \text{ K/W}$

IGBT thermal model values

R (K/W)	Tau (s)
3,03E-01	6,63E+00
6,11E-01	2,13E-01
3,21E+00	4,88E-02
8,43E-01	1,03E-02
5,62E-01	2,85E-03
2,59E-01	7,40E-04

figure 12. Output inverter FWD

FWD transient thermal impedance as a function of pulse width

$$Z_{th(j-s)} = f(t_p)$$

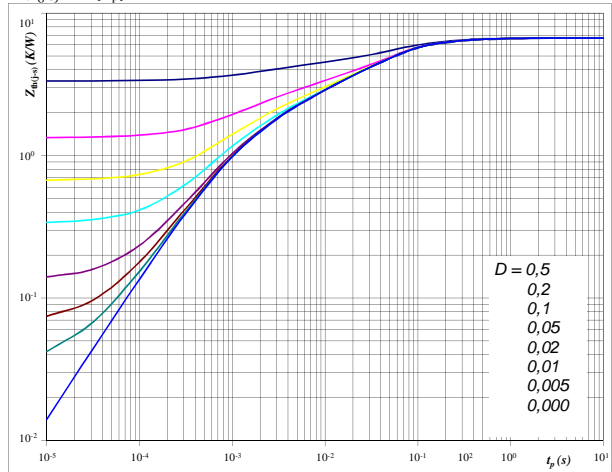

At

$D = t_p / T$
 $R_{th(j-s)} = 6,66 \text{ K/W}$

FWD thermal model values

R (K/W)	Tau (s)
6,16E-01	3,13E-01
3,07E+00	5,41E-02
7,56E-01	2,30E-02
1,19E+00	4,70E-03
9,47E-01	9,78E-04
7,59E-02	7,51E-04



Output Inverter

figure 17. Output inverter IGBT

Safe operating area as a function of collector-emitter voltage

$$I_C = f(V_{CE})$$

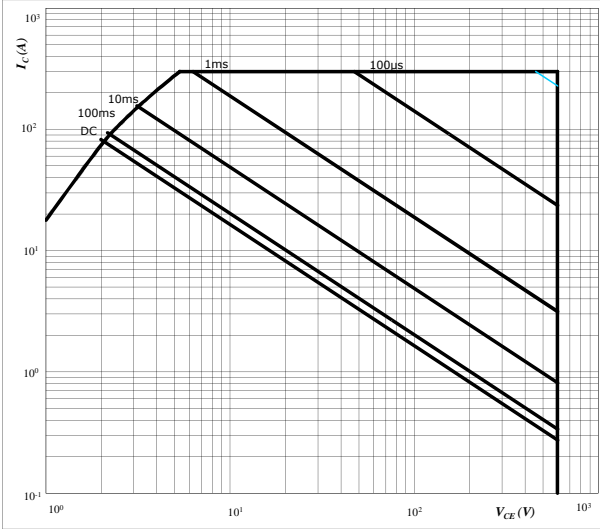

At

$$T_j \leq T_{jmax}$$

$$U_{CC} = 15 \text{ V}$$

figure 18. Output inverter IGBT

Reverse bias safe operating area

$$I_C = f(V_{CE})$$

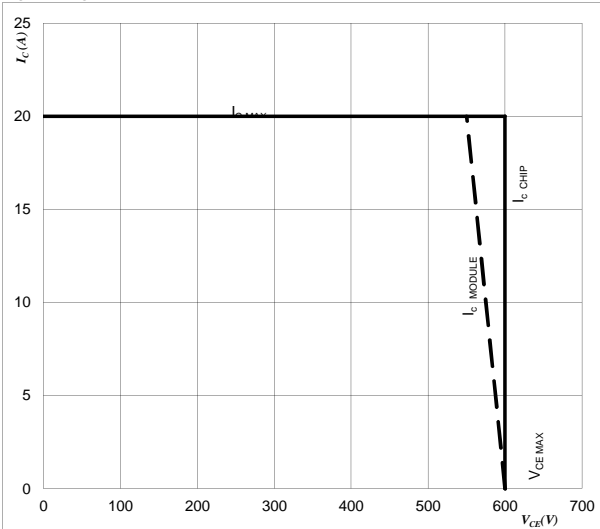

At

$$T_j = T_{jmax} - 25 \text{ } ^\circ\text{C}$$



PFC

figure 1. PFC IGBT

Typical output characteristics

$I_C = f(V_{CE})$

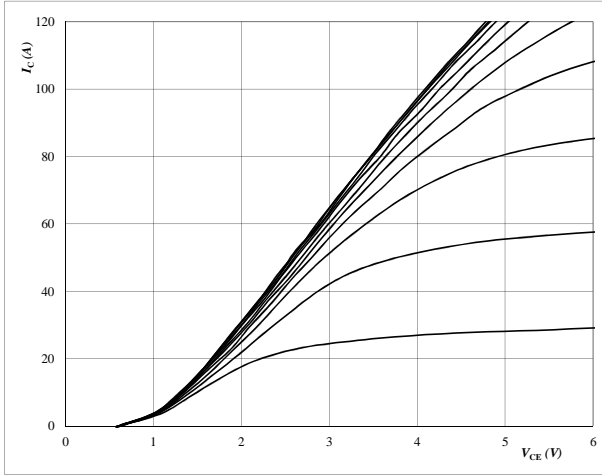

At

$t_p = 250 \mu s$
 $T_j = 25 \text{ } ^\circ C$
 U_{CC} from 7 V to 17 V in steps of 1 V

figure 2. PFC IGBT

Typical output characteristics

$I_C = f(V_{CE})$

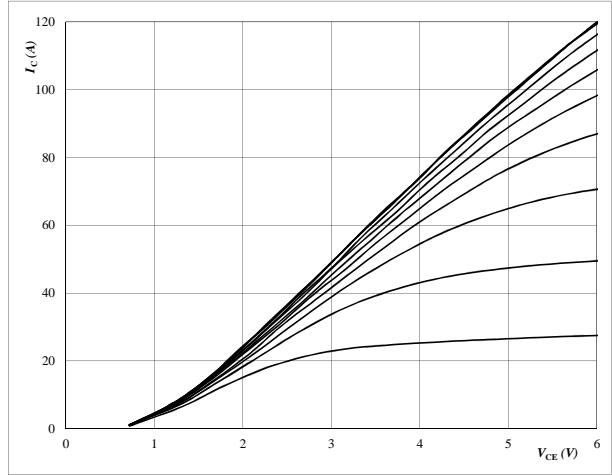

At

$t_p = 250 \mu s$
 $T_j = 125 \text{ } ^\circ C$
 U_{CC} from 7 V to 17 V in steps of 1 V

figure 3. PFC FWD

Typical diode forward current as a function of forward voltage

$I_F = f(V_F)$

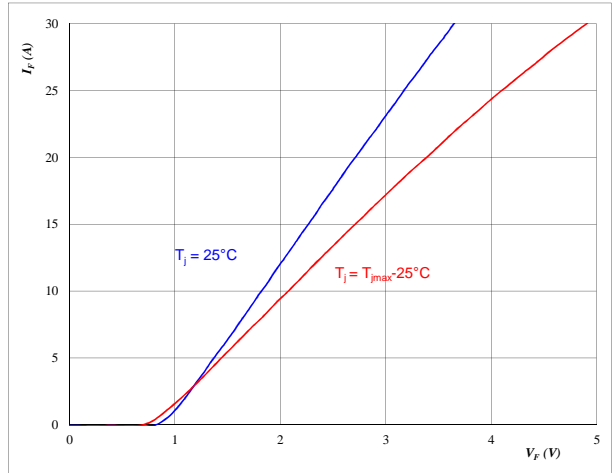

At

$t_p = 250 \mu s$



PFC

figure 4. PFC IGBT

Typical switching energy losses as a function of collector current

$E = f(I_c)$

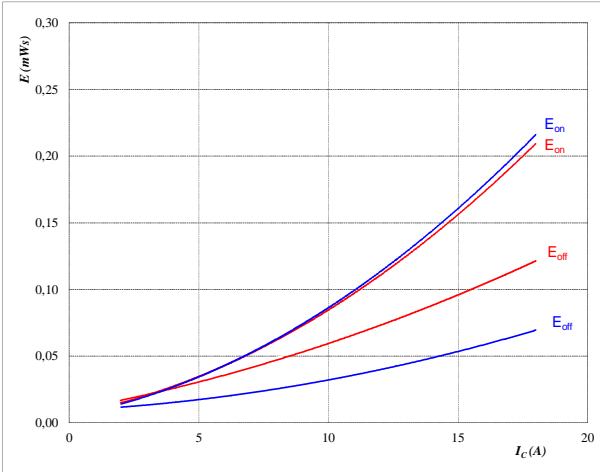

With an inductive load at

$T_j = 25/125$ °C

$V_{CE} = 400$ V

$U_{CC} = 15$ V

figure 5. PFC IGBT

Typical reverse recovery energy loss as a function of collector current

$E_{rec} = f(I_c)$

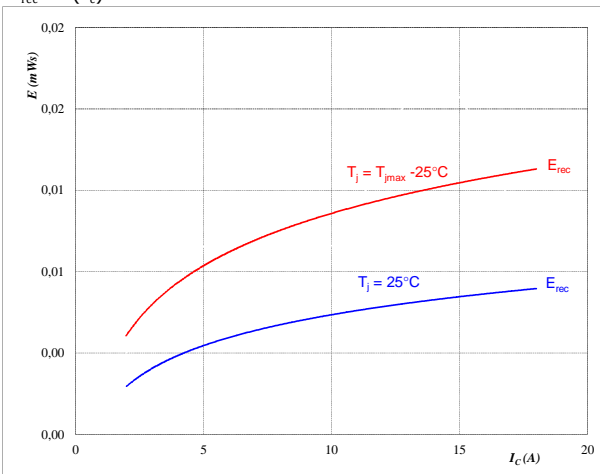

With an inductive load at

$T_j = 25/125$ °C

$V_{CE} = 400$ V

$U_{CC} = 15$ V



PFC

figure 6. PFC IGBT

Typical switching times as a function of collector current

$t = f(I_C)$

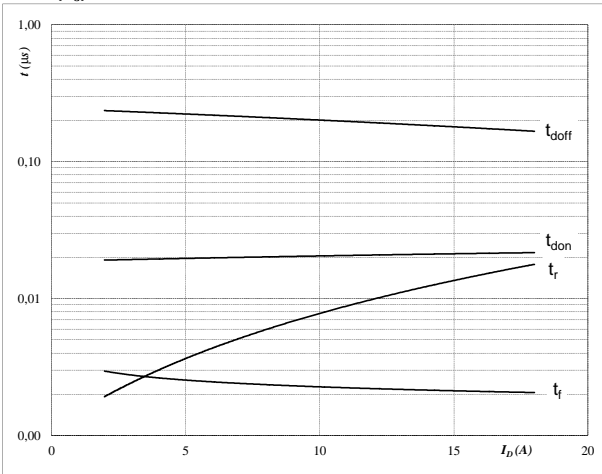

With an inductive load at

$T_j = 125$ °C

$V_{CE} = 400$ V

$U_{CC} = 15$ V

figure 7. PFC FWD

Typical reverse recovery time as a function of collector current

$t_{rr} = f(I_C)$

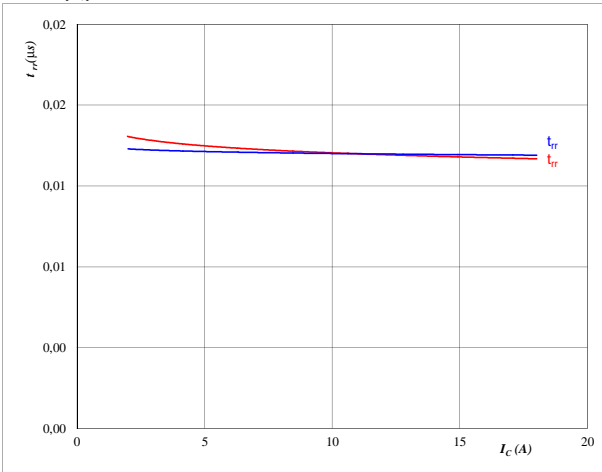

At

$T_j = 25/125$ °C

$V_{CE} = 400$ V

$U_{CC} = 15$ V



PFC

figure 8. PFC FWD

Typical reverse recovery charge as a function of collector current

$Q_{rr} = f(I_c)$

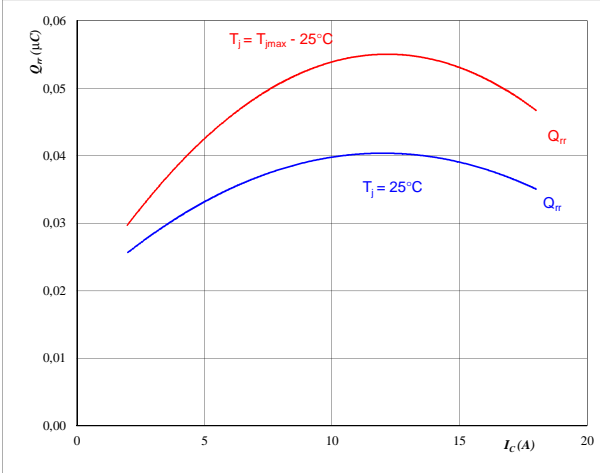

At

- $T_j = 25/125 \text{ } ^\circ\text{C}$
- $V_{CE} = 400 \text{ V}$
- $U_{CC} = 15 \text{ V}$

figure 9. PFC FWD

Typical reverse recovery current as a function of collector current

$I_{RRM} = f(I_c)$

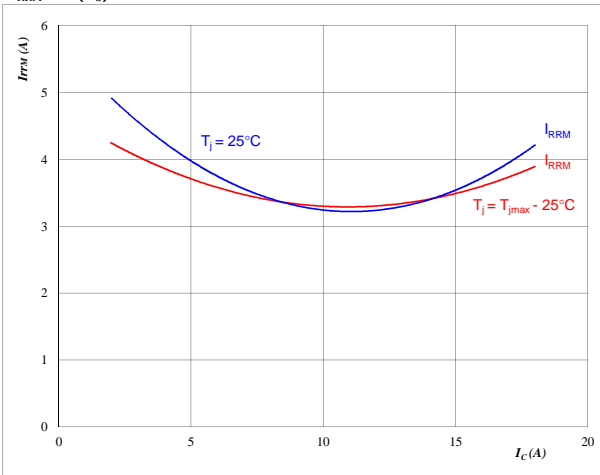

At

- $T_j = 25/125 \text{ } ^\circ\text{C}$
- $V_{CE} = 400 \text{ V}$
- $U_{CC} = 15 \text{ V}$



PFC

figure 10. PFC FWD

Typical rate of fall of forward and reverse recovery current as a function of collector current

$dI_0/dt, dI_{rec}/dt = f(I_c)$

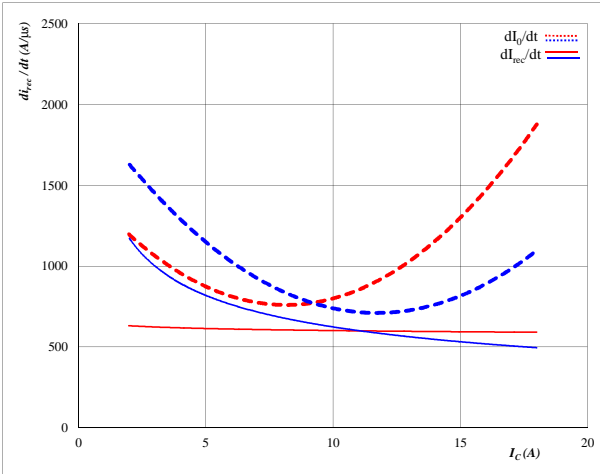

At

- $T_j = 25/125 \text{ } ^\circ\text{C}$
- $V_{CE} = 400 \text{ V}$
- $U_{CC} = 15 \text{ V}$

figure 11. PFC IGBT

IGBT transient thermal impedance as a function of pulse width

$Z_{th(j-s)} = f(t_p)$

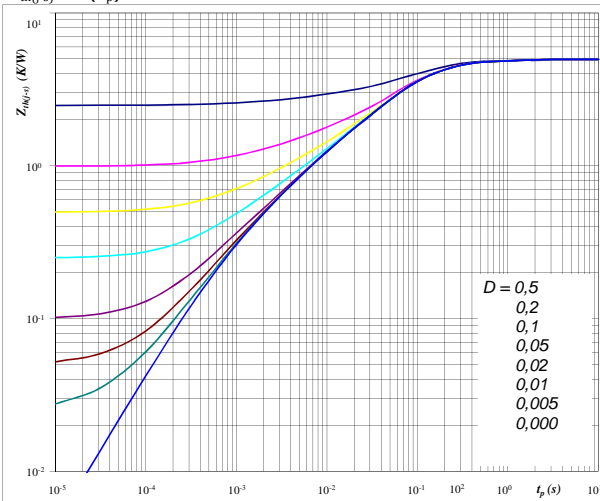

At

- $D = t_p / T$
- $R_{th(j-s)} = 4,96 \text{ K/W}$

IGBT thermal model values

R (K/W)	Tau (s)
4,18E-01	7,75E-01
2,55E+00	1,04E-01
1,29E+00	3,31E-02
5,60E-01	3,97E-03
1,42E-01	5,99E-04

figure 12. PFC FWD

FWD transient thermal impedance as a function of pulse width

$Z_{th(j-s)} = f(t_p)$

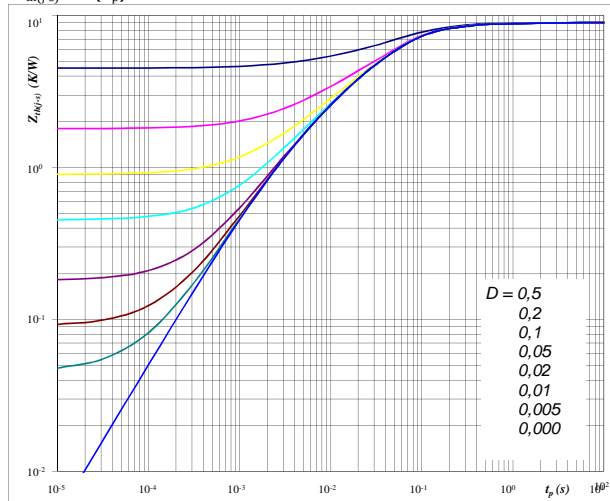

At

- $D = t_p / T$
- $R_{th(j-s)} = 9,02 \text{ K/W}$

FWD thermal model values

R (K/W)	Tau (s)
2,70E-01	2,21E+00
9,02E-01	2,29E-01
5,68E+00	5,28E-02
1,76E+00	9,35E-03
4,06E-01	1,91E-03



PFC

figure 17. PFC IGBT

Safe operating area as a function of collector-emitter voltage

$I_C = f(V_{CE})$

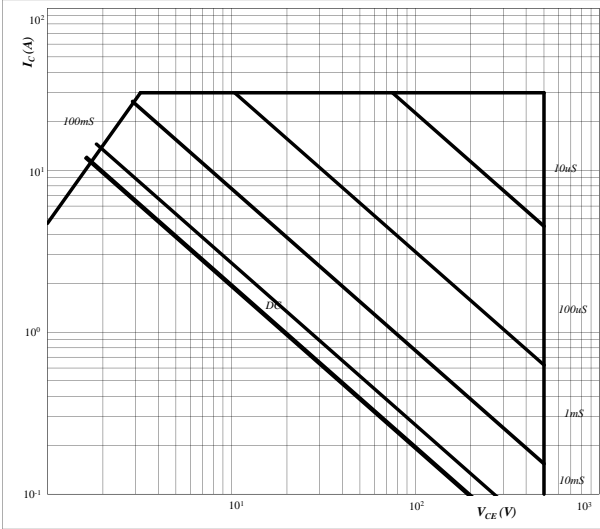

At

- $D =$ single pulse
- $T_s =$ 80 °C
- $U_{CC} =$ 15 V
- $T_j = T_{jmax}$

figure 18. PFC IGBT

Reverse bias safe operating area

$I_C = f(V_{CE})$

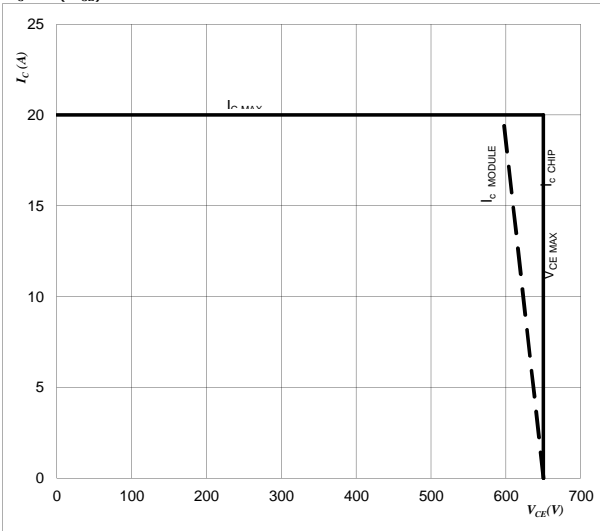

At

- $T_j = T_{jmax} - 25$ °C



Input Rectifier Diode

figure 1. Rectifier Diode

Typical diode forward current as a function of forward voltage

$I_F = f(V_F)$

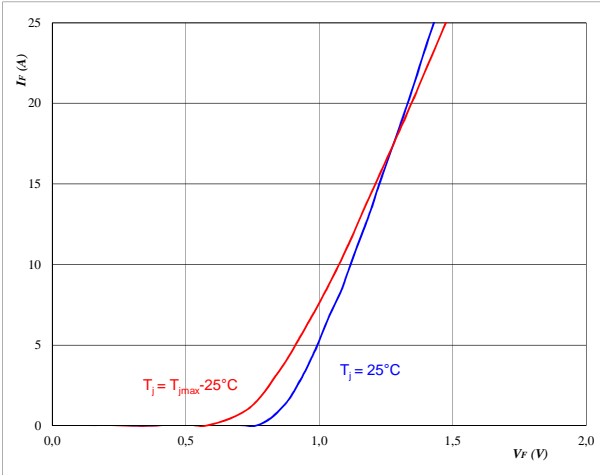

At $t_p = 250 \mu s$

figure 2. Rectifier Diode

Diode transient thermal impedance as a function of pulse width

$Z_{th(j-s)} = f(t_p)$

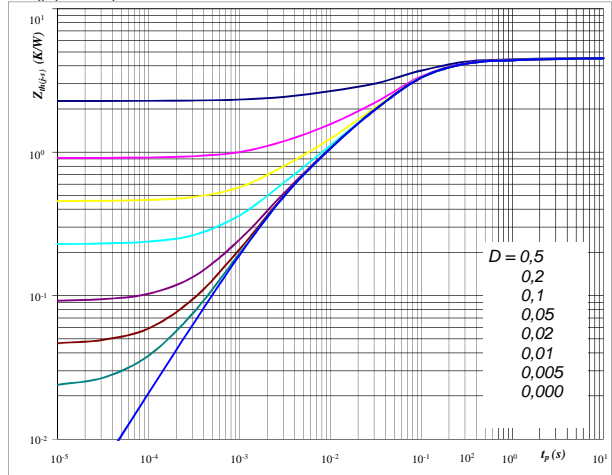

At $D = t_p / T$
 $R_{th(j-s)} = 4,56 \text{ K/W}$

Thermistor

figure 1. Thermistor

Typical NTC characteristic as a function of temperature

$R = f(T)$

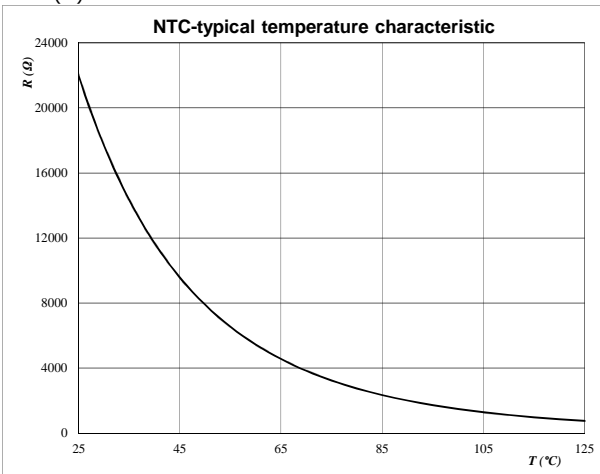



Switching Definitions Output Inverter

General conditions

$T_j = 125\text{ °C}$

figure 1. Output inverter IGBT
Turn-off Switching Waveforms & definition of t_{doff} , t_{Eoff}
(t_{Eoff} = integrating time for E_{off})

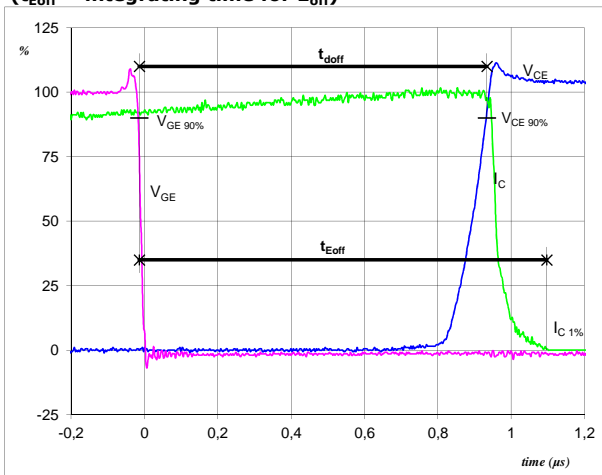

$U_{IN}(0\%) =$	0	V
$U_{IN}(100\%) =$	5	V
$V_C(100\%) =$	400	V
$I_C(100\%) =$	6	A
$t_{doff} =$	0,95	μs
$t_{Eoff} =$	1,11	μs

figure 2. Output inverter IGBT
Turn-on Switching Waveforms & definition of t_{don} , t_{Eon}
(t_{Eon} = integrating time for E_{on})

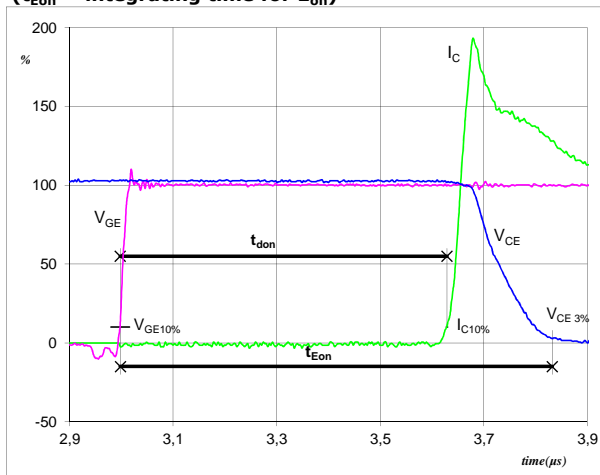

$U_{IN}(0\%) =$	0	V
$U_{IN}(100\%) =$	5	V
$V_C(100\%) =$	400	V
$I_C(100\%) =$	6	A
$t_{don} =$	0,63	μs
$t_{Eon} =$	0,83	μs

figure 3. Output inverter IGBT
Turn-off Switching Waveforms & definition of t_f

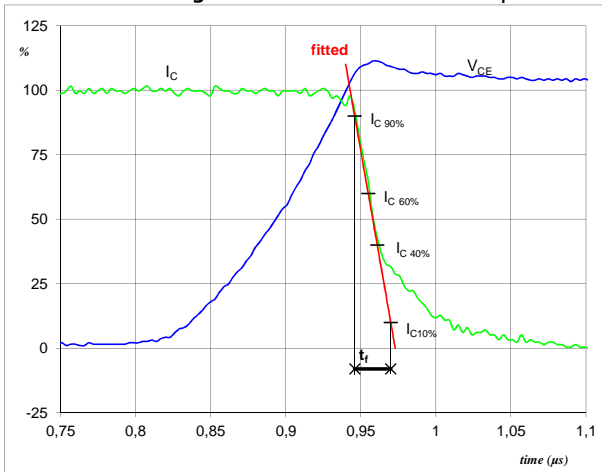

$V_C(100\%) =$	400	V
$I_C(100\%) =$	6	A
$t_f =$	0,02	μs

figure 4. Output inverter IGBT
Turn-on Switching Waveforms & definition of t_r

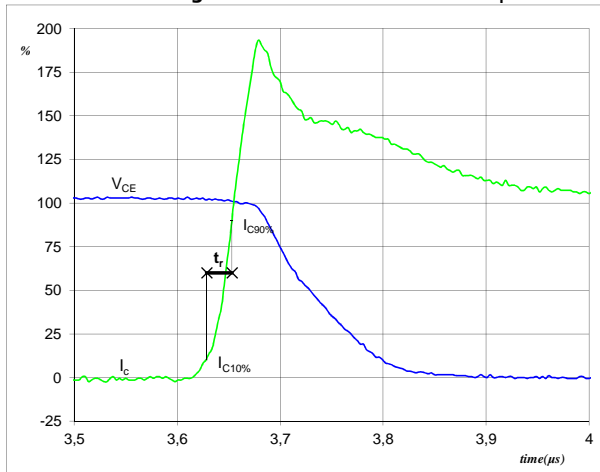

$V_C(100\%) =$	400	V
$I_C(100\%) =$	6	A
$t_r =$	0,03	μs



Switching Definitions Output Inverter

figure 5. Output inverter IGBT
Turn-off Switching Waveforms & definition of t_{Eoff}

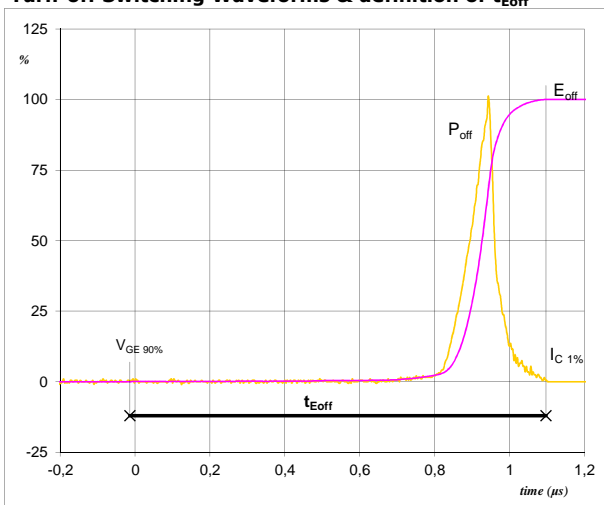

$P_{off}(100\%) = 2,39 \text{ kW}$
 $E_{off}(100\%) = 0,20 \text{ mJ}$
 $t_{Eoff} = 1,11 \text{ µs}$

figure 6. Output inverter IGBT
Turn-on Switching Waveforms & definition of t_{Eon}

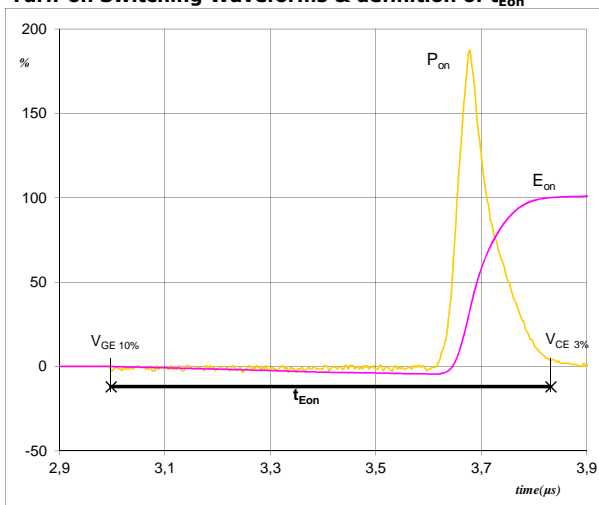

$P_{on}(100\%) = 2,39 \text{ kW}$
 $E_{on}(100\%) = 0,32 \text{ mJ}$
 $t_{Eon} = 0,83 \text{ µs}$

figure 7. Output inverter FWD
Turn-off Switching Waveforms & definition of t_{rr}

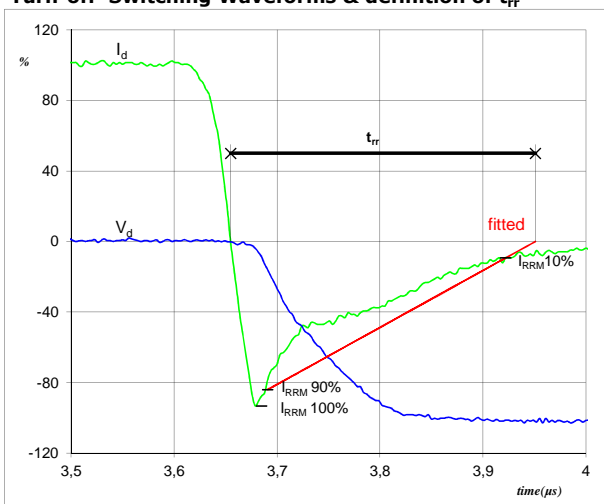

$V_d(100\%) = 400 \text{ V}$
 $I_d(100\%) = 6 \text{ A}$
 $I_{RRM}(100\%) = -6 \text{ A}$
 $t_{rr} = 0,28 \text{ µs}$



Switching Definitions Output Inverter

figure 8. Output inverter FWD
Turn-on Switching Waveforms & definition of t_{Qrr}
(t_{Qrr} = integrating time for Q_{rr})

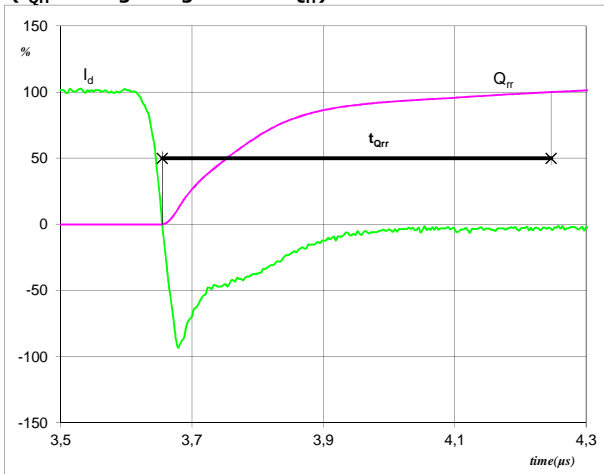

I_d (100%) =	6	A
Q_{rr} (100%) =	0,67	μC
t_{Qrr} =	0,59	μs

figure 9. Output inverter FWD
Turn-on Switching Waveforms & definition of t_{Erec}
(t_{Erec} = integrating time for E_{rec})

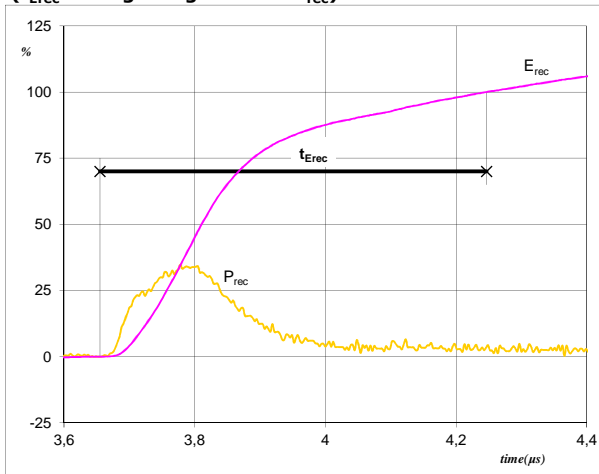

P_{rec} (100%) =	2,39	kW
E_{rec} (100%) =	0,16	mJ
t_{Erec} =	0,59	μs

Application data

Static logic function table

V_{CC}	V_{BS}	RCIN	ITRIP	ENABLE	FAULT	LO1,2,3	HO1,2,3
$< V_{CCUV-}$	X	X	X	X	0	0	0
15V	$< V_{BSUV-}$	X	0	3.3V	High imp	/LIN1,2,3	0
15V	15V	$< 3.2V_{\downarrow}$	0	3.3V	0	0	0
15V	15V	X	$> V_{IT,TH+}$	3.3V	0	0	0
15V	15V	$> V_{RCIN,TH}$	0	3.3V	High imp	/LIN1,2,3	/HIN1,2,3
15V	15V	$> V_{RCIN,TH}$	0	0	High imp	0	0

References for externally settable parameters

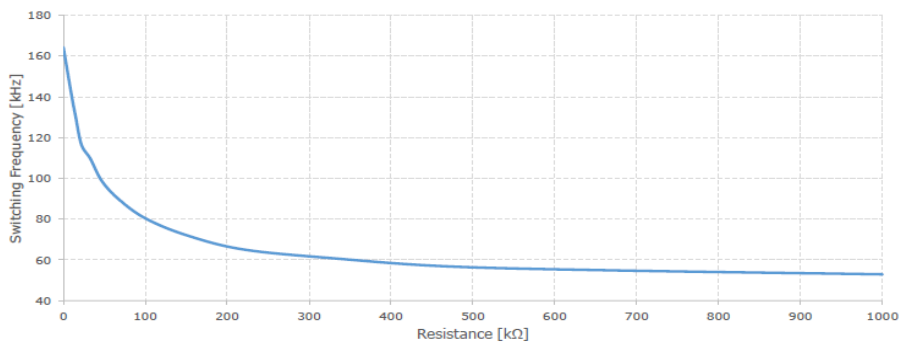

R_{fset} [kΩ]	Switching Frequency [kHz]
0	164
10	141
15	130
22	117
33	110
47	99
68	90
100	80
150	72
220	65
330	61
470	57
680	55
1000	53

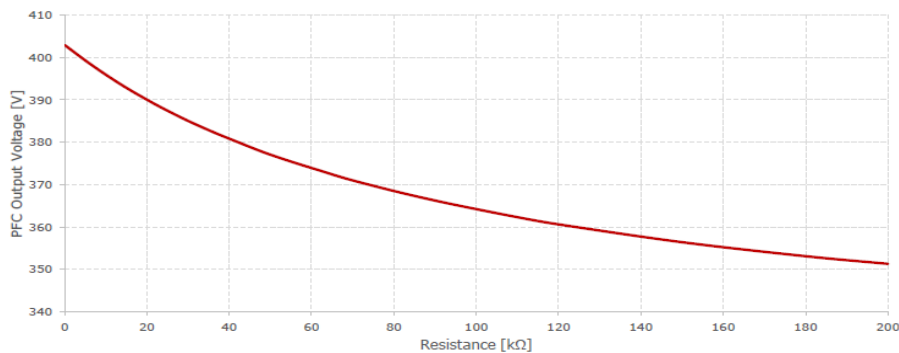

R_{Vset} [kΩ]	Output Voltage [V]
0	403
5,1	399
10	396
15	393
20	390
24	388
30	385
36	382
39	381
47	378
51	377
56	375
62	373
68	372
75	370
82	368
91	366
100	364
110	362
120	361
150	356
180	353
200	351

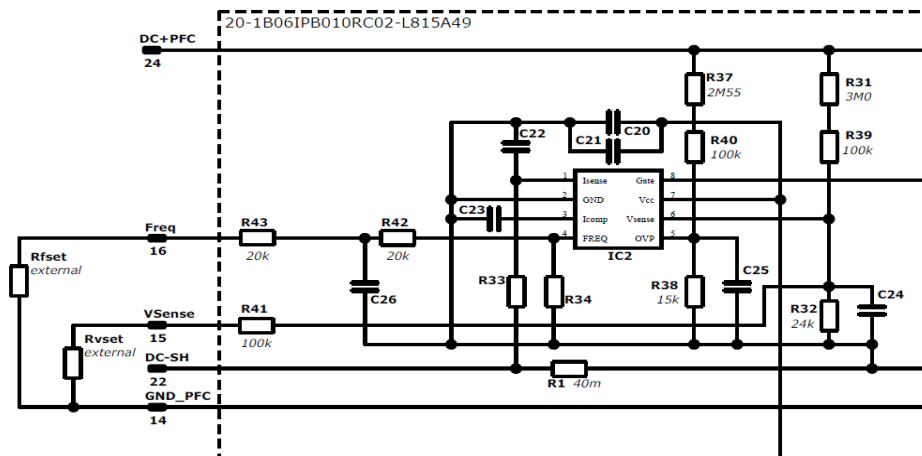

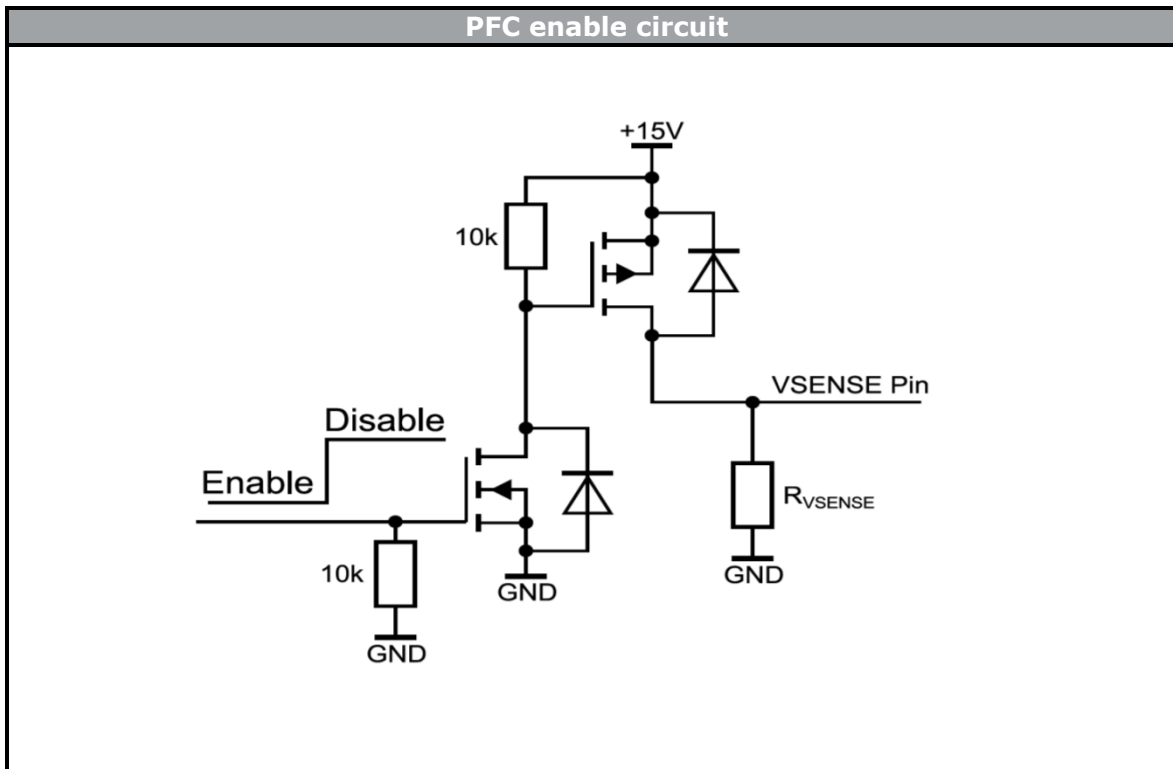

Pin Descriptions

Pin #	Pin Name	Pin Description
1	Therm1	Temperature sensor connector 1
2	COM	Low-side gate driver reference
3	ITRIP	Analog input for over-current shot down, activates FAULT
4	EN	Enable I/O functionality
5	¬Fault	Fault output, indicates over current or under voltage (negative logic, open-drain c
6	¬LIN3	Signal input for low-side Ph3 phase
7	¬LIN2	Signal input for low-side Ph2 phase
8	¬LIN1	Signal input for low-side Ph1 phase
9	¬HIN3	Signal input for high-side Ph3 phase
10	¬HIN2	Signal input for high-side Ph2 phase
11	¬HIN1	Signal input for high-side Ph1 phase
12	V _{CC}	Driver circuit supply voltage
13	GND_INV	Inverter ground
14	GND_PFC	PFC ground
15	VSENSE	PFC Bulk voltage sense
16	FREQ	PFC Switching frequency adjust
17	ACIn1	Rectifier input
18	ACIn2	Rectifier input
19	DC+Rect	Rectifier output DC +
20	PFC	PFC coil connector
21	DC-Rect	Rectifier output DC -
22	DC-SH	Current Sense Input for PFC Controller
23	DC-PFC	PFC capacitor GND (internally connected to GND_PFC)
24	DC+PFC	PFC capacitor + (output of the PFC stage)
25	DC+INV	Inverter input DC +
26	Ph3	Output for Ph3 phase
27	Ph2	Output for Ph2 phase
28	Ph1	Output for Ph1 phase
29	DC-3	Inverter input DC - for Ph3
30	DC-3SH+	Inverter Sense Resistor for Ph3 - High Side
31	DC-2SH+	Inverter Sense Resistor for Ph2 - High Side
32	DC-2	Inverter input DC - for Ph2
33	DC-1	Inverter input DC - for Ph1
34	DC-1SH+	Inverter Sense Resistor for Ph2 - High Side



Ordering Code & Marking						
Version			Ordering Code			
without thermal paste 17 mm housing with solder pins			20-1B06IPB010RC02-L815A49			
with thermal paste 17 mm housing with solder pins			20-1B06IPB010RC02-L815A49-/3/			
			Name	Date code	UL & VIN	Lot
Text			NN-NNNNNNNNNNNNNN-TTTTTTVV	WWYY	UL VIN	LLLLL SSSS
Datamatrix			Type&Ver	Lot number	Serial	Date code
			TTTTTTTVV	LLLLL	SSSS	WWYY

Outline							
Pin table [mm]				Pin table [mm]			
Pin	X	Y	Function	Pin	X	Y	Function
1	45,2	0	NTC	19	10	26,4	DC+Rect
2	42,2	0	COM	20	15	26,4	PFC
3	39,2	0	ITRIP	21	20	26,4	DC-Rect
4	36,2	0	EN	22	22,7	26,4	DC-SH
5	33,2	0	FAULT	23	25,4	26,4	DC-PFC
6	30,2	0	LIN3	24	30,4	26,4	DC+PFC
7	27,2	0	LIN2	25	33,1	26,4	DC+Inv
8	24,2	0	LIN1	26	38,1	26,4	Ph3
9	21,2	0	HIN3	27	43,1	26,4	Ph2
10	18,2	0	HIN2	28	45,4	21,9	Ph1
11	15,2	0	HIN1	29	28,3	20,1	DC-3
12	12,2	0	VCC	30	27,3	17,6	DC-3SH
13	9,2	0	GND_INV	31	32,4	14,2	DC-2SH
14	6,2	0	GND_PFC	32	34,9	14,2	DC-2
15	3,2	0	VSEN	33	41,5	10,9	DC-1
16	0,2	0	FREQ	34	39	6,3	DC-1SH
17	0	26,4	ACIn1				
18	5	26,4	ACIn2				

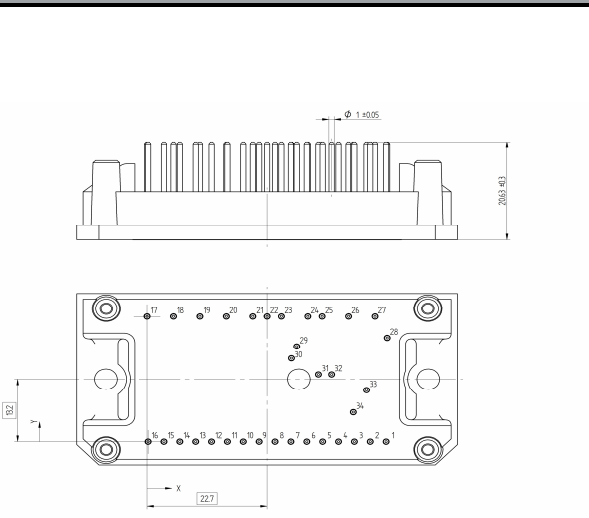

Tolerance of pinposition: ±0.5mm at the end of pins
Dimension of coordinate axis is only offset without tolerance

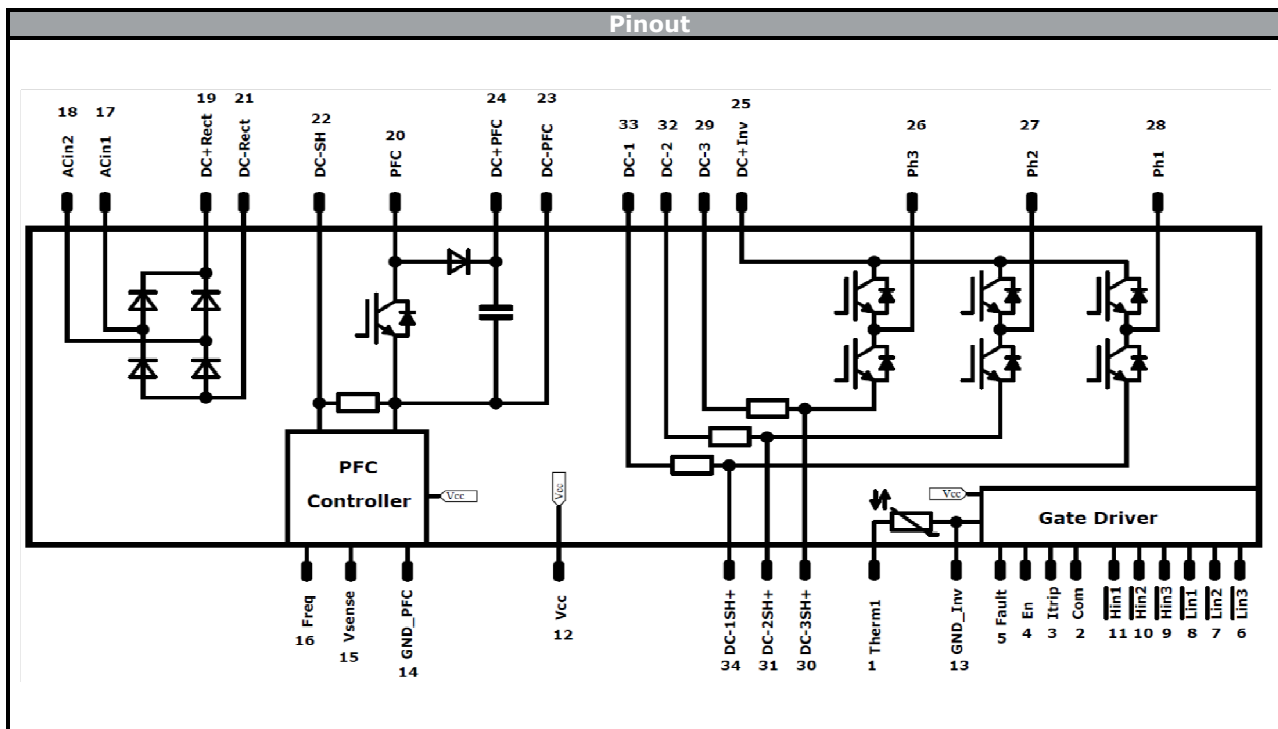

Identification					
ID	Component	Voltage	Current	Function	Comment
T1-T6	IGBT	600 V	10 A	Inverter Switch	
T27	IGBT	650 V	30 A	PFC Switch	
D27	FWD	650 V	8 A	PFC Diode	
D47	FWD	650 V	6 A	PFC Inverse Diode	
R4	Resistor			PFC Shunt	
D31-D34	Rectifier	1600 V	7 A	Rectifier Diode	
R1-R3	Resistor			DC Link Shunt	
C1	Capacitor	500 V		Capacitor (DC)	
Rt	Thermistor			Thermistor	



Packaging instruction			
Standard packaging quantity (SPQ)	100	>SPQ	Standard <SPQ Sample

Handling instruction
Handling instructions for <i>flow</i> 1B packages see vincotech.com website.

Package data
Package data for <i>flow</i> 1B packages see vincotech.com website.

UL recognition and file number
This device is certified according to UL 1557 standard, UL file number E192116. For more information see vincotech.com website. 

Document No.:	Date:	Modification:	Pages
20-1B06IPB010RC02-L815A49-D5-14	18 Sept. 2020	Update condition of OVP parameters Add simplified schematic to show Rvset, Rfset resistor Correct Pin description table	7 24 25

DISCLAIMER

The information, specifications, procedures, methods and recommendations herein (together "information") are presented by Vincotech to reader in good faith, are believed to be accurate and reliable, but may well be incomplete and/or not applicable to all conditions or situations that may exist or occur. Vincotech reserves the right to make any changes without further notice to any products to improve reliability, function or design. No representation, guarantee or warranty is made to reader as to the accuracy, reliability or completeness of said information or that the application or use of any of the same will avoid hazards, accidents, losses, damages or injury of any kind to persons or property or that the same will not infringe third parties rights or give desired results. It is reader's sole responsibility to test and determine the suitability of the information and the product for reader's intended use.

LIFE SUPPORT POLICY

Vincotech products are not authorised for use as critical components in life support devices or systems without the express written approval of Vincotech.

As used herein:

1. Life support devices or systems are devices or systems which, (a) are intended for surgical implant into the body, or (b) support or sustain life, or (c) whose failure to perform when properly used in accordance with instructions for use provided in la
2. A critical component is any component of a life support device or system whose failure to perform can be reasonably expected to cause the failure of the life support device or system, or to affect its safety or effectiveness.