

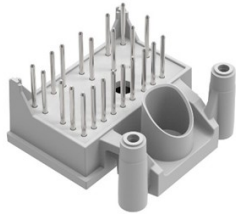
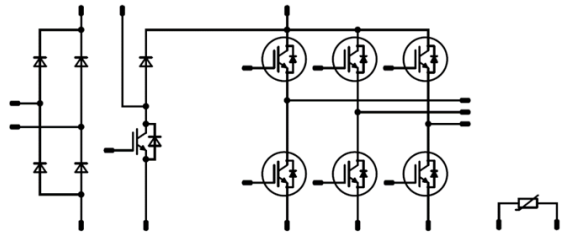

Vincotech

<i>flowPIM 0B + PFC</i>	600 V / 6 A
<div style="border: 1px solid black; padding: 5px; margin-bottom: 10px;"> <p style="text-align: center; background-color: #cccccc; margin: 0;">Features</p> <ul style="list-style-type: none"> Converter, PFC, inverter in one housing High speed IGBT for PFC One screw heatsink mounting </div> <div style="border: 1px solid black; padding: 5px; margin-bottom: 10px;"> <p style="text-align: center; background-color: #cccccc; margin: 0;">Target applications</p> <ul style="list-style-type: none"> Embedded Drives </div> <div style="border: 1px solid black; padding: 5px;"> <p style="text-align: center; background-color: #cccccc; margin: 0;">Types</p> <ul style="list-style-type: none"> 10-0B06PPA006RC-L023A09 </div>	<div style="border: 1px solid black; padding: 5px; margin-bottom: 10px;"> <p style="text-align: center; background-color: #cccccc; margin: 0;"><i>flow 0B 17 mm housing</i></p>  </div> <div style="border: 1px solid black; padding: 5px;"> <p style="text-align: center; background-color: #cccccc; margin: 0;">Schematic</p>  </div>

Maximum Ratings

$T_j = 25\text{ }^\circ\text{C}$, unless otherwise specified

Parameter	Symbol	Condition	Value	Unit
Rectifier Diode				
Peak repetitive reverse voltage	V_{RRM}		1600	V
Continuous (direct) forward current	I_F	$T_j = T_{jmax}$ $T_s = 80\text{ }^\circ\text{C}$	18	A
Repetitive peak forward current	I_{FRM}	60 Hz Single Half Sine Wave	150	A
Total power dissipation	P_{tot}	$T_j = T_{jmax}$ $T_s = 80\text{ }^\circ\text{C}$	34	W
Maximum junction temperature	T_{jmax}		150	°C



Vincotech

Maximum Ratings

$T_j = 25\text{ °C}$, unless otherwise specified

Parameter	Symbol	Condition	Value	Unit
Inverter Switch				
Collector-emitter voltage	V_{CES}		600	V
Collector current	I_C	$T_j = T_{jmax}$ $T_s = 80\text{ °C}$	8	A
Repetitive peak collector current	I_{CRM}	t_p limited by T_{jmax}	18	A
Turn off safe operating area		$T_j \leq 150\text{ °C}$, $V_{CE} \leq 600\text{ V}$	12	A
Total power dissipation	P_{tot}	$T_j = T_{jmax}$ $T_s = 80\text{ °C}$	39	W
Gate-emitter voltage	V_{GES}		± 20	V
Short circuit ratings	t_{SC}	$V_{GE} = 15\text{ V}$ $V_{CE} = 400\text{ V}$ $T_j = 150\text{ °C}$	5	μs
Maximum junction temperature	T_{jmax}		175	$^{\circ}\text{C}$
Inverter Diode				
Peak repetitive reverse voltage	V_{RRM}		600	V
Continuous (direct) forward current	I_F	$T_j = T_{jmax}$ $T_s = 80\text{ °C}$	8	A
Total power dissipation	P_{tot}	$T_j = T_{jmax}$ $T_s = 80\text{ °C}$	39	W
Maximum junction temperature	T_{jmax}		175	$^{\circ}\text{C}$
PFC Switch				
Collector-emitter voltage	V_{CES}		650	V
Collector current	I_C	$T_j = T_{jmax}$ $T_s = 80\text{ °C}$	21	A
Repetitive peak collector current	I_{CRM}	t_p limited by T_{jmax}	45	A
Turn off safe operating area		$T_j \leq 175\text{ °C}$, $V_{CE} \leq 650\text{ V}$	45	A
Total power dissipation	P_{tot}	$T_j = T_{jmax}$ $T_s = 80\text{ °C}$	44	W
Gate-emitter voltage	V_{GES}		± 20	V
Maximum junction temperature	T_{jmax}		175	$^{\circ}\text{C}$
PFC Diode				
Peak repetitive reverse voltage	V_{RRM}		650	V
Continuous (direct) forward current	I_F	$T_j = T_{jmax}$ $T_s = 80\text{ °C}$	15	A
Repetitive peak forward current	I_{FRM}		30	A
Total power dissipation	P_{tot}	$T_j = T_{jmax}$ $T_s = 80\text{ °C}$	43	W
Maximum junction temperature	T_{jmax}		175	$^{\circ}\text{C}$



Vincotech

Maximum Ratings

$T_j = 25\text{ °C}$, unless otherwise specified

Parameter	Symbol	Condition	Value	Unit
PFC Sw. Protection Diode				
Peak repetitive reverse voltage	V_{RRM}		650	V
Continuous (direct) forward current	I_F	$T_j = T_{jmax}$ $T_s = 80\text{ °C}$	8	A
Repetitive peak forward current	I_{FRM}		12	A
Total power dissipation	P_{tot}	$T_j = T_{jmax}$ $T_s = 80\text{ °C}$	32	W
Maximum junction temperature	T_{jmax}		175	°C

Module Properties

Thermal Properties

Storage temperature	T_{stg}		-40...+125	°C
Operation temperature under switching condition	T_{top}		-40...(T _{jmax} - 25)	°C

Isolation Properties

Isolation voltage	V_{isol}	DC Test Voltage* $t_p = 2\text{ s}$	6000	V
		AC Voltage $t_p = 1\text{ min}$	2500	V
Creepage distance			min. 12,7	mm
Clearance			min. 12,7	mm
Comparative Tracking Index	CTI		> 200	

*100 % tested in production



Vincotech

Characteristic Values

Parameter	Symbol	Conditions					Value			Unit
		V_{GE} [V] V_{GS} [V]	V_{CE} [V] V_{DS} [V] V_F [V]	I_C [A] I_D [A] I_F [A]	T_j [°C]	Min	Typ	Max		

Rectifier Diode

Static

Forward voltage	V_F				7	25 125		1,04 0,97	1,14	V
Reverse leakage current	I_R			1600		25			20	μA

Thermal

Thermal resistance junction to sink	$R_{th(j-s)}$	$\lambda_{paste} = 3,4$ W/mK (PSX)						2,09		K/W
-------------------------------------	---------------	---------------------------------------	--	--	--	--	--	------	--	-----

Inverter Switch

Static

Gate-emitter threshold voltage	$V_{GE(th)}$	$V_{GE} = V_{CE}$			0,00011	25	4,4	5	5,6	V
Collector-emitter saturation voltage	$V_{CE(sat)}$		15		6	25 125 150	1,88	2,23 2,33 2,34	2,62	V
Collector-emitter cut-off current	I_{CES}		0	600		25			2	μA
Gate-emitter leakage current	I_{GES}		20	0		25			120	nA
Internal gate resistance	r_g							none		Ω
Input capacitance	C_{ies}							470		pF
Output capacitance	C_{oes}	$f = 1$ Mhz	0	25		25		24		
Reverse transfer capacitance	C_{res}							14		
Gate charge	Q_g		15	480	6	25		48		nC

Thermal

Thermal resistance junction to sink	$R_{th(j-s)}$	$\lambda_{paste} = 3,4$ W/mK (PSX)						2,41		K/W
-------------------------------------	---------------	---------------------------------------	--	--	--	--	--	------	--	-----

Dynamic

Turn-on delay time	$t_{d(on)}$					25 125		106 102		ns
Rise time	t_r	$R_{gon} = 64$ Ω $R_{goff} = 64$ Ω				25 125		18 22		
Turn-off delay time	$t_{d(off)}$		±15	400	6	25 125		121 127		
Fall time	t_f					25 125		8 50		
Turn-on energy (per pulse)	E_{on}	$Q_{tFWD} = 0,3$ μC $Q_{tFWD} = 0,5$ μC				25 125		0,160 0,241		
Turn-off energy (per pulse)	E_{off}					25 125		0,078 0,112		



Vincotech

Characteristic Values

Parameter	Symbol	Conditions					Value			Unit
		V_{GE} [V] V_{GS} [V]	V_{CE} [V] V_{DS} [V] V_F [V]	I_C [A] I_D [A] I_F [A]	T_j [°C]	Min	Typ	Max		

Inverter Diode

Static

Forward voltage	V_F				6	25 125 150		2,33 2,18 2,14	2,6	V
-----------------	-------	--	--	--	---	------------------	--	----------------------	-----	---

Thermal

Thermal resistance junction to sink	$R_{th(j-s)}$	$\lambda_{paste} = 3,4 \text{ W/mK}$ (PSX)						2,41		K/W
-------------------------------------	---------------	---	--	--	--	--	--	------	--	-----

Dynamic

Peak recovery current	I_{RRM}	$di/dt = 410 \text{ A}/\mu\text{s}$ $di/dt = 227 \text{ A}/\mu\text{s}$	± 15	400	6	25		4		A
Reverse recovery time	t_{rr}					125		5		
						25		192		
Recovered charge	Q_r					125		235		
						25		0,309		
Reverse recovered energy	E_{rec}					125		0,531		
		25		0,085						
Peak rate of fall of recovery current	$(di_{rf}/dt)_{max}$	125		0,138						
		25		58						
						125		46		A/ μs



Vincotech

Characteristic Values

Parameter	Symbol	Conditions					Value			Unit
		V_{GS} [V]	V_{GE} [V]	V_{DS} [V]	I_D [A]	T_j [°C]	Min	Typ	Max	

PFC Switch

Static

Parameter	Symbol	$V_{GE} = V_{CE}$	V_{GS} [V]	V_{CE} [V]	I_C [A]	T_j [°C]	Min	Typ	Max	Unit
Gate-emitter threshold voltage	$V_{GE(th)}$				0,0004	25	3,3	4	4,7	V
Collector-emitter saturation voltage	V_{CEsat}		15		15	25 125 150		1,64 1,77 1,80	2,22	V
Collector-emitter cut-off current	I_{CES}		0	650		25			40	μA
Gate-emitter leakage current	I_{GES}		20	0		25			120	nA
Internal gate resistance	r_g							none		Ω
Input capacitance	C_{ies}							930		pF
Output capacitance	C_{oes}	$f = 1$ Mhz	0	25		25		24		
Reverse transfer capacitance	C_{res}							4		
Gate charge	Q_g		15	520	15	25		38		nC

Thermal

Parameter	Symbol	$\lambda_{paste} = 3,4$ W/mK (PSX)	V_{GS} [V]	V_{CE} [V]	I_D [A]	T_j [°C]	Min	Typ	Max	Unit
Thermal resistance junction to sink	$R_{th(j-s)}$							2,14		K/W

Dynamic

Parameter	Symbol	$R_{gon} = 32$ Ω $R_{goff} = 32$ Ω	V_{GS} [V]	V_{CE} [V]	I_D [A]	T_j [°C]	Min	Typ	Max	Unit
Turn-on delay time	$t_{d(on)}$					25 125 150		17 17 18		ns
Rise time	t_r					25 125 150		25 26 26		
Turn-off delay time	$t_{d(off)}$					25 125 150		129 141 145		
Fall time	t_f					25 125 150		14 14 14		
Turn-on energy (per pulse)	E_{on}	$Q_{t-FWD} = 0,5$ μC $Q_{t-FWD} = 0,9$ μC $Q_{t-FWD} = 1$ μC				25 125 150		0,418 0,535 0,571		mWs
Turn-off energy (per pulse)	E_{off}					25 125 150		0,106 0,141 0,154		



Vincotech

Characteristic Values

Parameter	Symbol	Conditions					Value			Unit
		V_{GE} [V] V_{GS} [V]	V_{CE} [V] V_{DS} [V]	I_C [A] I_D [A]	I_D [A] I_F [A]	T_j [°C]	Min	Typ	Max	

PFC Diode

Static

Forward voltage	V_F				15	25 125 150		1,51 1,43 1,39	1,92	V
Reverse leakage current	I_R			650		25			0,94	μ A

Thermal

Thermal resistance junction to sink	$R_{th(j-s)}$	$\lambda_{paste} = 3,4$ W/mK (PSX)						2,19		K/W
-------------------------------------	---------------	---------------------------------------	--	--	--	--	--	------	--	-----

Dynamic

Peak recovery current	I_{RRM}					25 125 150		8 12 13		A
Reverse recovery time	t_{rr}					25 125 150		88 114 125		ns
Recovered charge	Q_r	$di/dt = 616$ A/ μ s $di/dt = 605$ A/ μ s $di/dt = 593$ A/ μ s	0 / 15	400	15	25 125 150		0,463 0,949 1,047		μ C
Reverse recovered energy	E_{rec}					25 125 150		0,101 0,222 0,244		mWs
Peak rate of fall of recovery current	$(di_{rr}/dt)_{max}$					25 125 150		390 241 171		A/ μ s

PFC Sw. Protection Diode

Static

Forward voltage	V_F				6	25 125 150		1,73 1,59 1,54	1,87	V
Reverse leakage current	I_R			650		25			0,1	μ A

Thermal

Thermal resistance junction to sink	$R_{th(j-s)}$	$\lambda_{paste} = 3,4$ W/mK (PSX)						3,01		K/W
-------------------------------------	---------------	---------------------------------------	--	--	--	--	--	------	--	-----



Vincotech

Characteristic Values

Parameter	Symbol	Conditions					Value			Unit
		V_{GS} [V]	V_{GE} [V]	V_{DS} [V]	V_F [V]	I_D [A] I_F [A]	T_j [°C]	Min	Typ	

Thermistor

Rated resistance	R					25		22		k Ω
Deviation of R_{100}	$\Delta_{R/R}$	$R_{100} = 1484 \Omega$				100	-5		5	%
Power dissipation	P					25		5		mW
Power dissipation constant						25		1,5		mW/K
B-value	$B_{(25/50)}$	Tol. ± 1 %				25		3962		K
B-value	$B_{(25/100)}$	Tol. ± 1 %				25		4000		K
Vincotech NTC Reference									I	



Rectifier Diode Characteristics

figure 1. FWD

Typical forward characteristics

$$I_F = f(V_F)$$

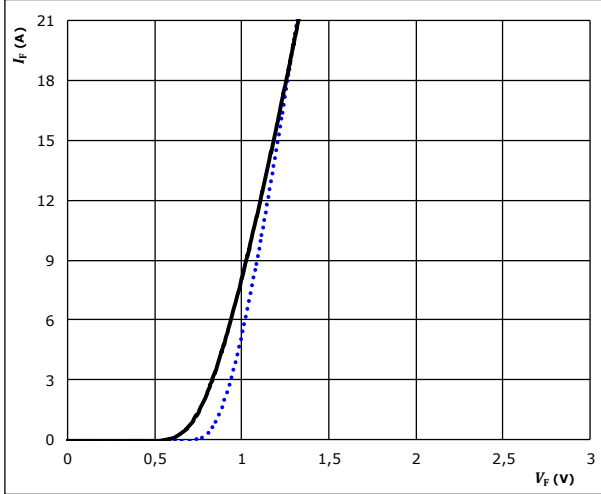

$t_p = 250 \mu s$ $T_j: 25 \text{ }^\circ\text{C}$ (dotted blue line) $125 \text{ }^\circ\text{C}$ (solid black line)

figure 2. FWD

Transient thermal impedance as a function of pulse width

$$Z_{th(j-s)} = f(t_p)$$

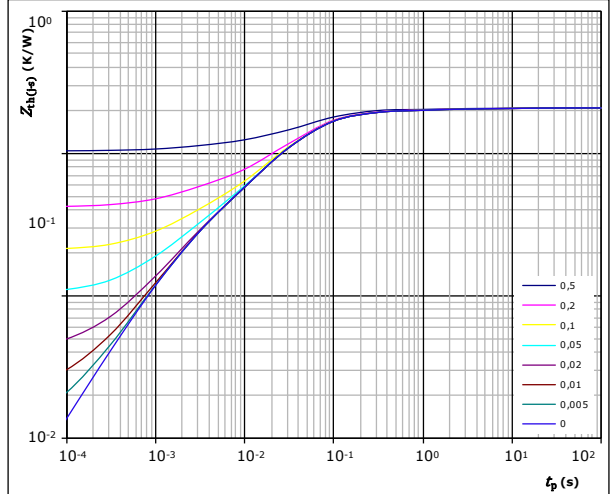

$D = t_p / T$
 $R_{th(j-s)} = 2,09 \text{ K/W}$

FWD thermal model values

R (K/W)	τ (s)
4,86E-02	1,03E+01
1,45E-01	6,91E-01
1,18E+00	6,09E-02
5,40E-01	1,88E-02
1,74E-01	1,96E-03



Inverter Switch Characteristics

figure 1. IGBT

Typical output characteristics

$I_C = f(V_{CE})$

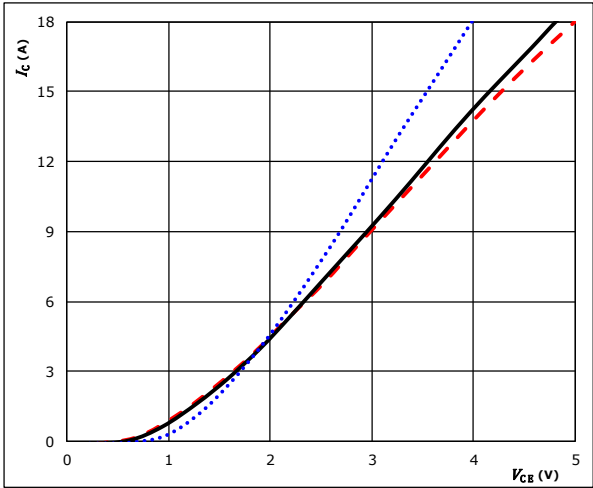

$t_p = 250 \mu s$
 $V_{GE} = 15 V$
 $T_j: 25 \text{ } ^\circ C$ (dotted blue line)
 $125 \text{ } ^\circ C$ (solid black line)
 $150 \text{ } ^\circ C$ (dashed red line)

figure 2. IGBT

Typical output characteristics

$I_C = f(V_{CE})$

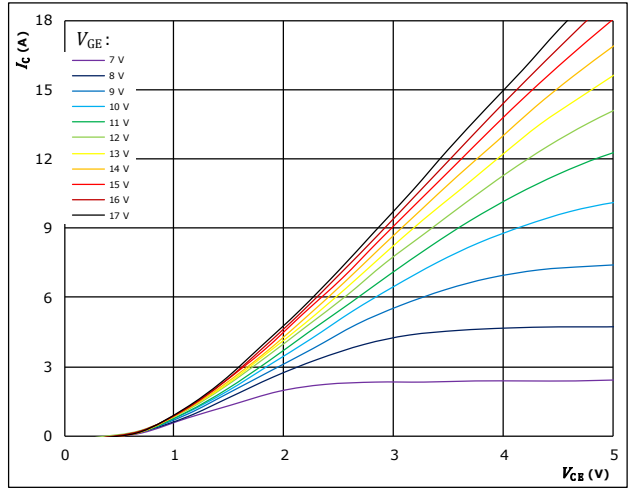

$t_p = 250 \mu s$
 $T_j = 150 \text{ } ^\circ C$
 V_{GE} from 7 V to 17 V in steps of 1 V

figure 3. IGBT

Typical transfer characteristics

$I_C = f(V_{GE})$

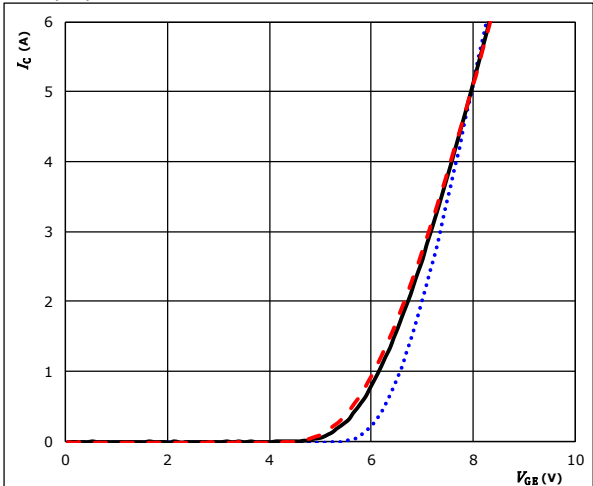

$t_p = 100 \mu s$
 $V_{CE} = 10 V$
 $T_j: 25 \text{ } ^\circ C$ (dotted blue line)
 $125 \text{ } ^\circ C$ (solid black line)
 $150 \text{ } ^\circ C$ (dashed red line)

figure 4. IGBT

Transient thermal impedance as function of pulse duration

$Z_{th(j-s)} = f(t_p)$

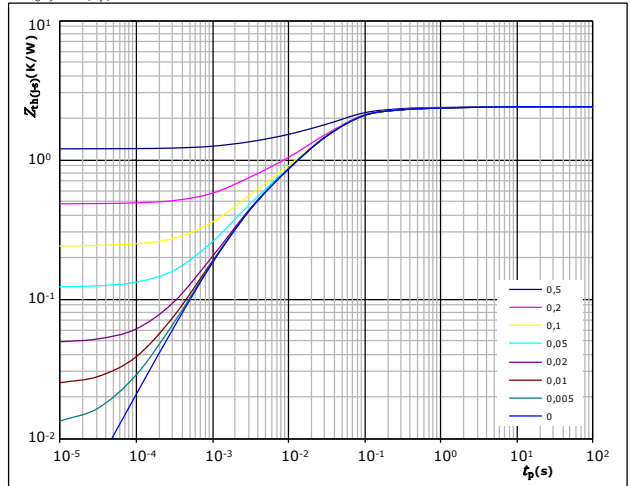

$D = t_p / T$
 $R_{th(j-s)} = 2,41 \text{ K/W}$

IGBT thermal model values

R (K/W)	τ (s)
7,21E-02	2,78E+00
1,73E-01	2,71E-01
1,45E+00	4,23E-02
4,08E-01	1,17E-02
3,14E-01	2,24E-03



Inverter Switch Characteristics

figure 5. IGBT

Gate voltage vs gate charge

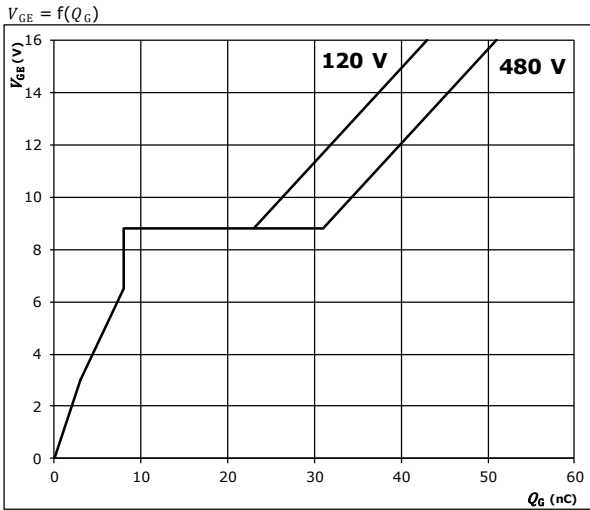

$I_C = 6 \text{ A}$

figure 6. IGBT

Safe operating area

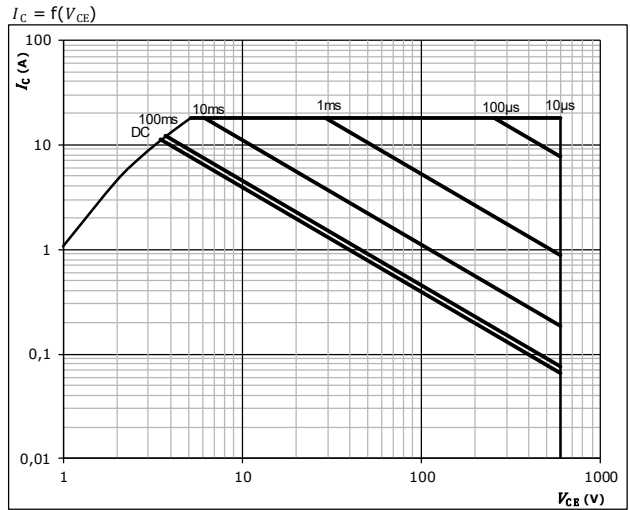

$D =$ single pulse
 $T_s = 80 \text{ } ^\circ\text{C}$
 $V_{GE} = \pm 15 \text{ V}$
 $T_j = T_{jmax}$

figure 7. IGBT

Short circuit duration as a function of V_{GE}

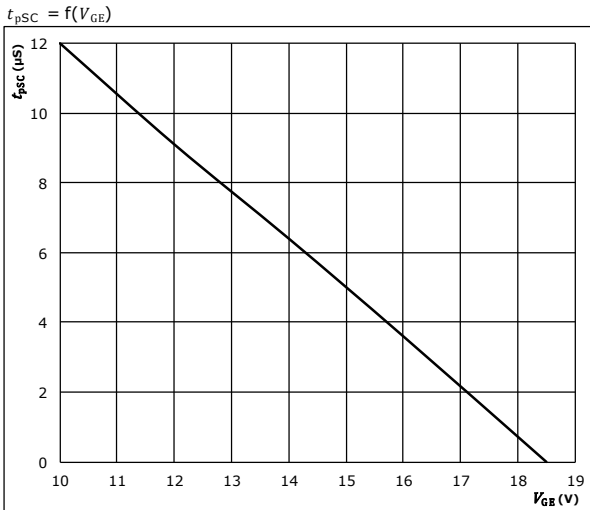

$V_{CE} = 400 \text{ V}$
 $T_j \leq 150 \text{ } ^\circ\text{C}$

figure 8. IGBT

Typical short circuit current as a function of V_{GE}

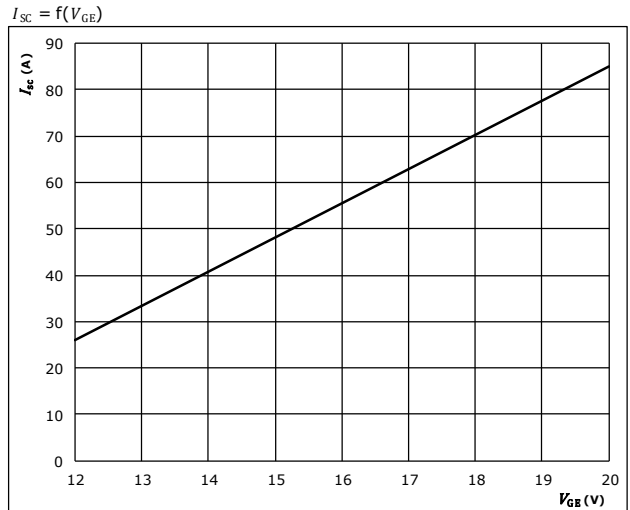

$V_{CE} \leq 400 \text{ V}$
 $T_j \leq 25 \text{ } ^\circ\text{C}$



Inverter Diode Characteristics

figure 1. FWD

Typical forward characteristics

$$I_F = f(V_F)$$

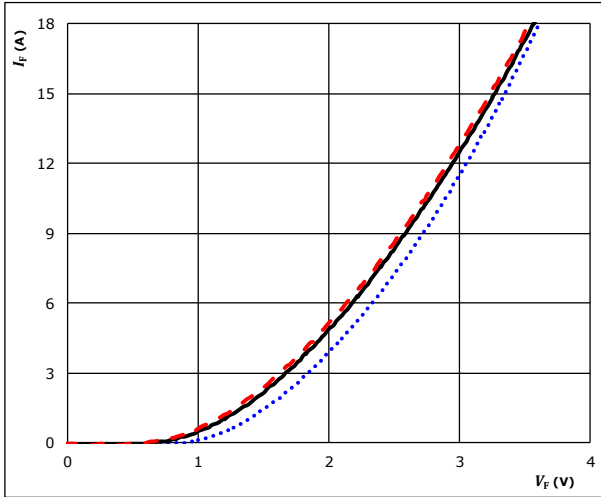

$t_p = 250 \mu s$
 T_j : 25 °C
 125 °C ———
 150 °C - - - -

figure 2. FWD

Transient thermal impedance as a function of pulse width

$$Z_{th(j-s)} = f(t_p)$$

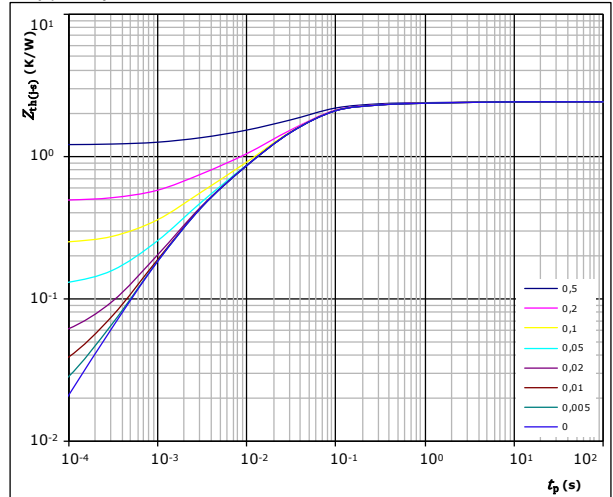

$D = t_p / T$
 $R_{th(j-s)} = 2,41 \text{ K/W}$
 FWD thermal model values

$R \text{ (K/W)}$	$\tau \text{ (s)}$
7,21E-02	2,78E+00
1,73E-01	2,71E-01
1,45E+00	4,23E-02
4,08E-01	1,17E-02
3,14E-01	2,24E-03



PFC Switch Characteristics

figure 1. IGBT

Typical output characteristics

$$I_C = f(V_{CE})$$

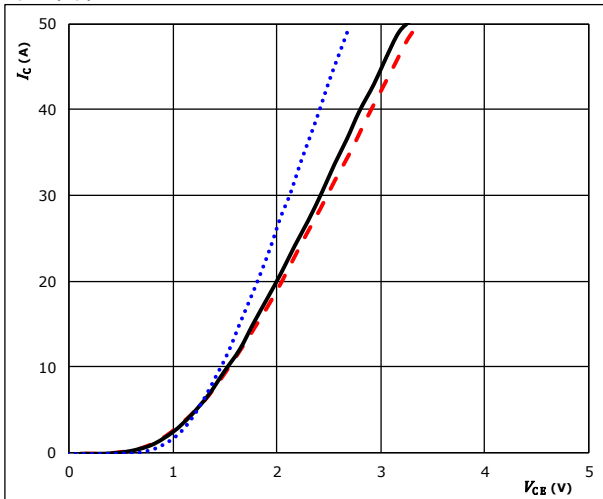

$t_p = 250 \mu s$
 $V_{GE} = 15 V$
 $T_j: 25 \text{ } ^\circ C$ (dotted blue)
 $125 \text{ } ^\circ C$ (solid black)
 $150 \text{ } ^\circ C$ (dashed red)

figure 2. IGBT

Typical output characteristics

$$I_C = f(V_{CE})$$

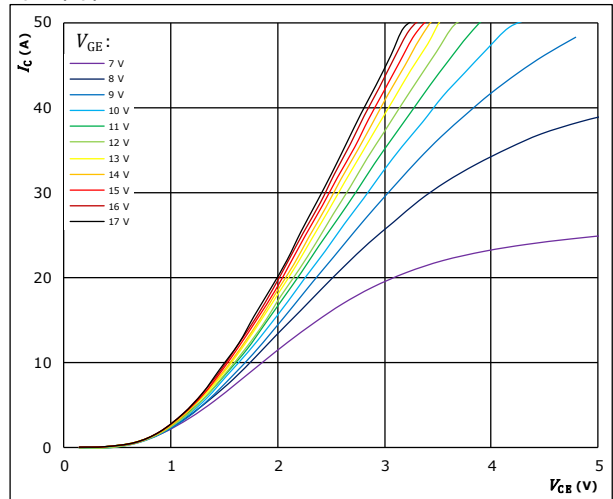

$t_p = 250 \mu s$
 $T_j = 150 \text{ } ^\circ C$
 V_{GE} from 7 V to 17 V in steps of 1 V

figure 3. IGBT

Typical transfer characteristics

$$I_C = f(V_{GE})$$

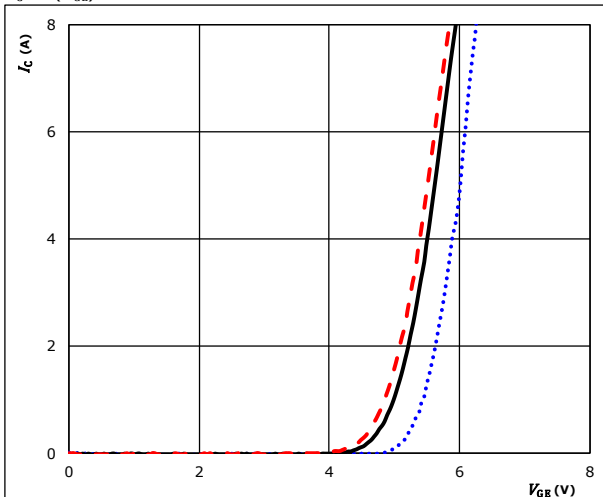

$t_p = 100 \mu s$
 $V_{CE} = 10 V$
 $T_j: 25 \text{ } ^\circ C$ (dotted blue)
 $125 \text{ } ^\circ C$ (solid black)
 $150 \text{ } ^\circ C$ (dashed red)

figure 4. IGBT

Transient thermal impedance as function of pulse duration

$$Z_{th(j-s)} = f(t_p)$$

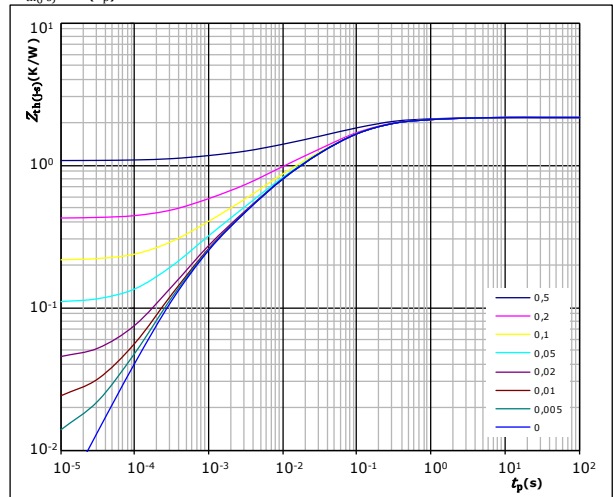

$D = t_p / T$
 $R_{th(j-s)} = 2,14 \text{ K/W}$
 IGBT thermal model values

R (K/W)	τ (s)
1,10E-01	1,85E+00
3,05E-01	2,58E-01
8,44E-01	6,42E-02
4,55E-01	1,26E-02
2,79E-01	3,05E-03
1,45E-01	4,84E-04



PFC Switch Characteristics

figure 5. IGBT

Gate voltage vs gate charge

$V_{GE} = f(Q_G)$

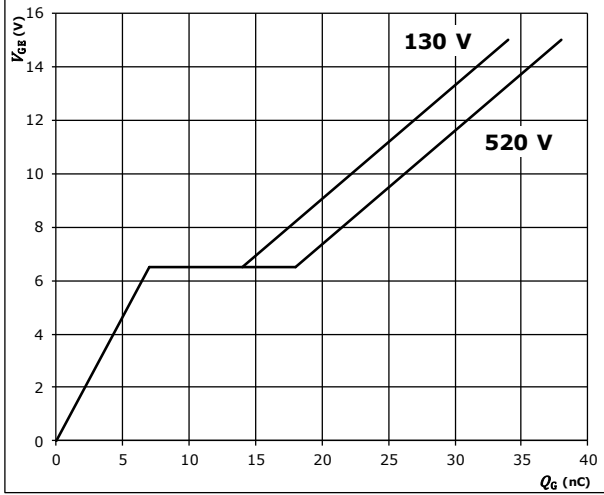

$I_C = 15$ A

figure 6. IGBT

Safe operating area

$I_C = f(V_{CE})$

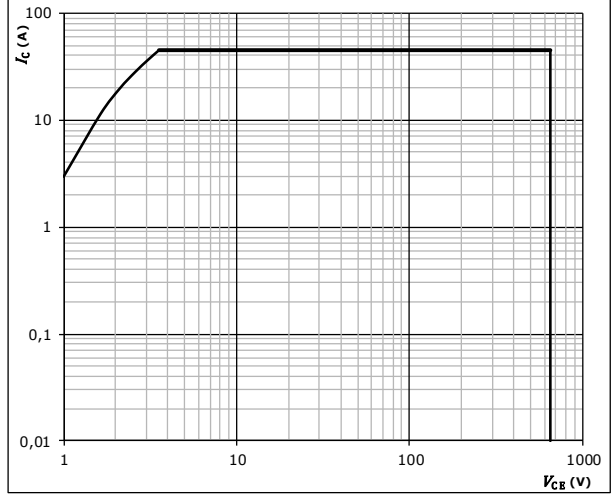

$D =$ single pulse
 $T_s = 80$ °C
 $V_{GE} = \pm 15$ V
 $T_j = T_{jmax}$



PFC Diode Characteristics

figure 1. FWD

Typical forward characteristics

$$I_F = f(V_F)$$

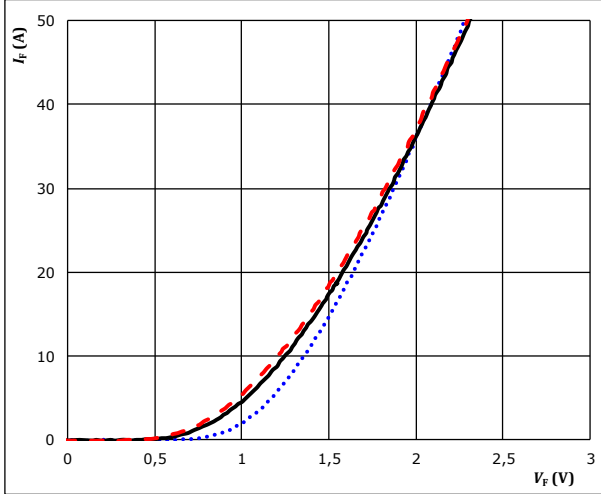

$t_p = 250 \mu s$
 T_j : 25 °C
 125 °C ———
 150 °C - - - -

figure 2. FWD

Transient thermal impedance as a function of pulse width

$$Z_{th(j-s)} = f(t_p)$$

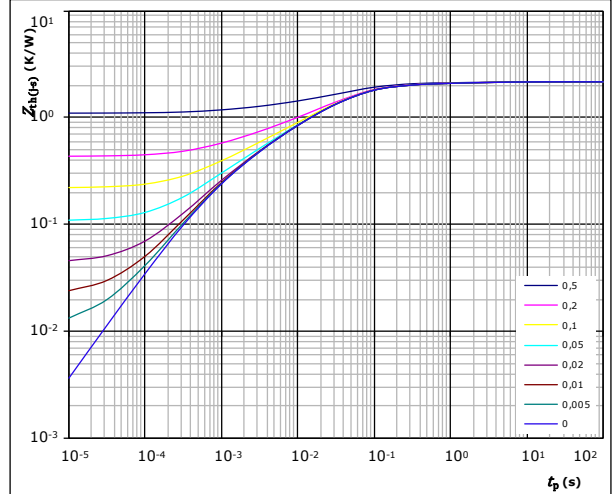

$D = t_p / T$
 $R_{th(j-s)} = 2,19 \text{ K/W}$
 FWD thermal model values

R (K/W)	τ (s)
6,49E-02	4,22E+00
1,67E-01	4,66E-01
9,76E-01	5,57E-02
5,62E-01	1,45E-02
3,00E-01	2,81E-03
1,17E-01	5,62E-04



PFC Sw. Protection Diode Characteristics

figure 1. FWD

Typical forward characteristics

$$I_F = f(V_F)$$

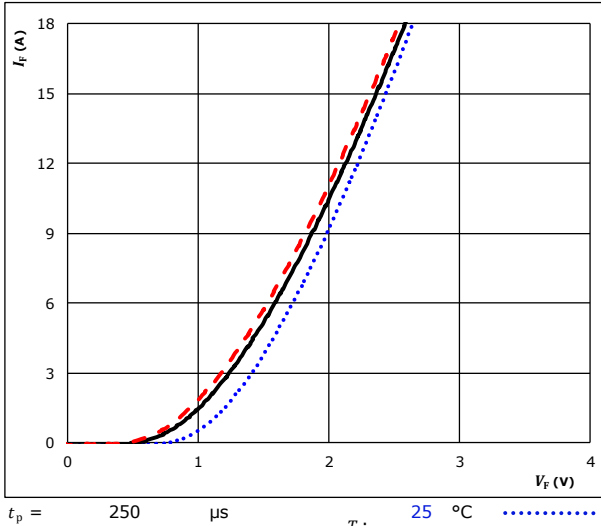
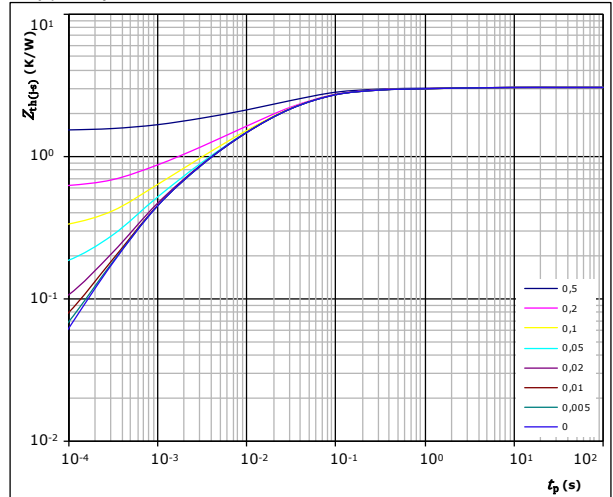

figure 2. FWD

Transient thermal impedance as a function of pulse width

$$Z_{th(j-s)} = f(t_p)$$



$$D = t_p / T$$

$$R_{th(j-s)} = 3,01 \text{ K/W}$$

FWD thermal model values

R (K/W)	τ (s)
5,15E-02	9,38E+00
9,53E-02	8,91E-01
3,22E-01	1,25E-01
1,35E+00	2,97E-02
8,32E-01	8,19E-03
3,58E-01	1,78E-03

Thermistor Characteristics

figure 1. Thermistor

Typical NTC characteristic as a function of temperature

$$R = f(T)$$

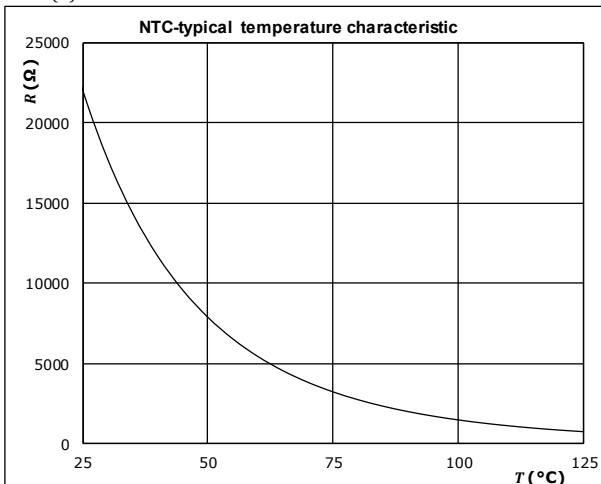



Inverter Switching Characteristics

figure 1. IGBT

Typical switching energy losses as a function of collector current

$$E = f(I_c)$$

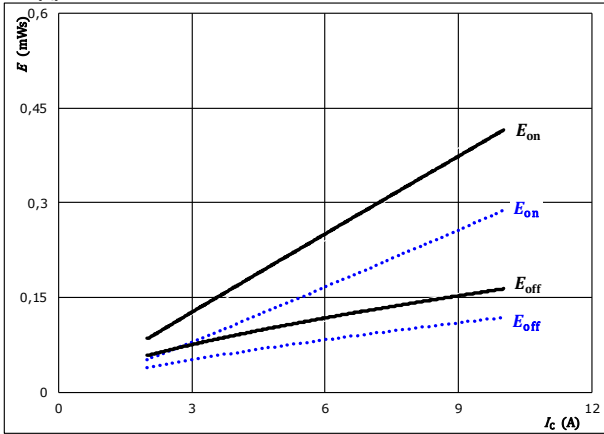

With an inductive load at T_j : 25 °C (dotted blue line) / 125 °C (solid black line)

$V_{CE} = 400$ V
 $V_{GE} = \pm 15$ V
 $R_{gon} = 64$ Ω
 $R_{goff} = 64$ Ω

figure 2. IGBT

Typical switching energy losses as a function of gate resistor

$$E = f(R_g)$$

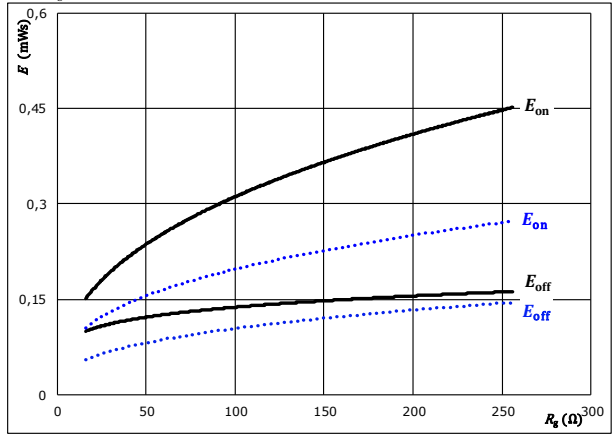

With an inductive load at T_j : 25 °C (dotted blue line) / 125 °C (solid black line)

$V_{CE} = 400$ V
 $V_{GE} = \pm 15$ V
 $I_c = 6$ A

figure 3. FWD

Typical reverse recovered energy loss as a function of collector current

$$E_{rec} = f(I_c)$$

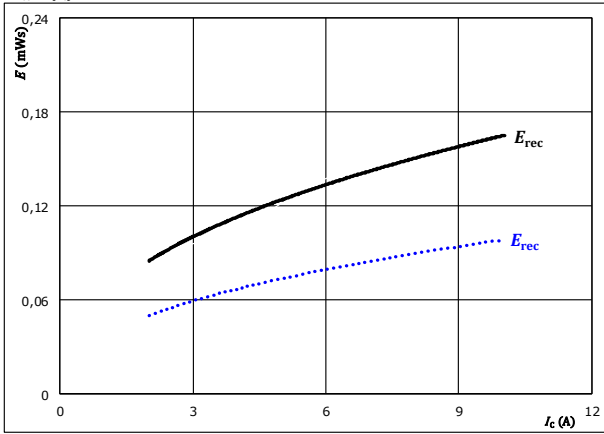

With an inductive load at T_j : 25 °C (dotted blue line) / 125 °C (solid black line)

$V_{CE} = 400$ V
 $V_{GE} = \pm 15$ V
 $R_{gon} = 64$ Ω

figure 4. FWD

Typical reverse recovered energy loss as a function of gate resistor

$$E_{rec} = f(R_g)$$

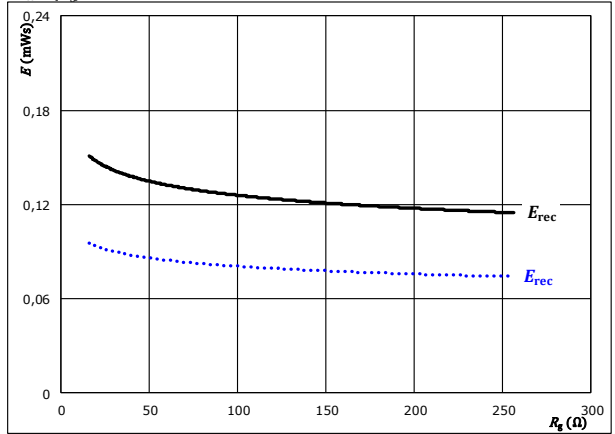

With an inductive load at T_j : 25 °C (dotted blue line) / 125 °C (solid black line)

$V_{CE} = 400$ V
 $V_{GE} = \pm 15$ V
 $I_c = 6$ A



Inverter Switching Characteristics

figure 5. IGBT

Typical switching times as a function of collector current

$$t = f(I_C)$$

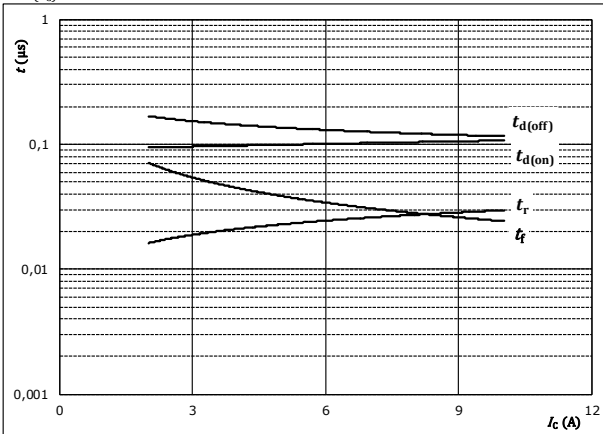

With an inductive load at

$T_j = 150$ °C
 $V_{CE} = 400$ V
 $V_{GE} = \pm 15$ V
 $R_{gon} = 64$ Ω
 $R_{goff} = 64$ Ω

figure 6. IGBT

Typical switching times as a function of gate resistor

$$t = f(R_g)$$

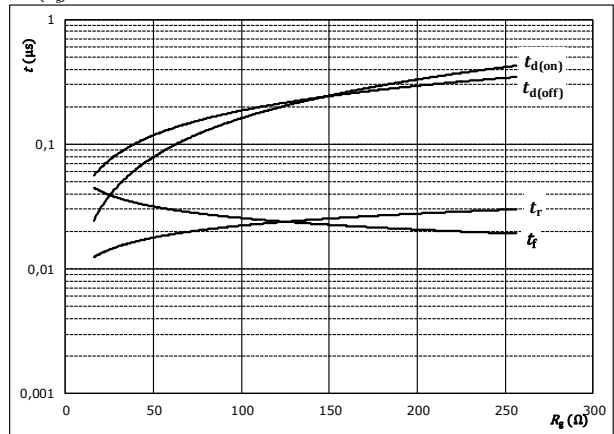

With an inductive load at

$T_j = 150$ °C
 $V_{CE} = 400$ V
 $V_{GE} = \pm 15$ V
 $I_C = 6$ A

figure 7. FWD

Typical reverse recovery time as a function of collector current

$$t_{rr} = f(I_C)$$

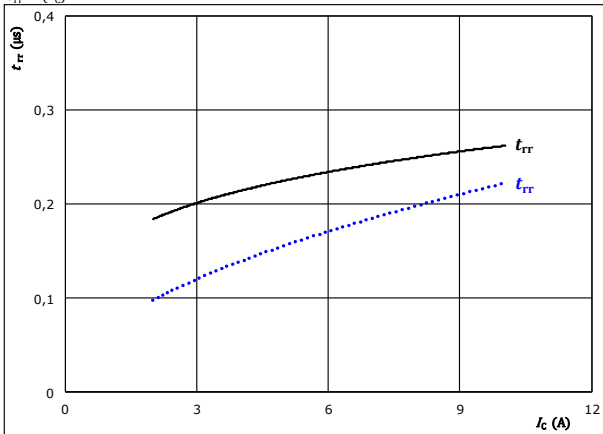

With an inductive load at

$V_{CE} = 400$ V
 $V_{GE} = \pm 15$ V
 $R_{gon} = 64$ Ω

T_j : 25 °C (dotted)
 125 °C (solid)

figure 8. FWD

Typical reverse recovery time as a function of IGBT turn on gate resistor

$$t_{rr} = f(R_{gon})$$

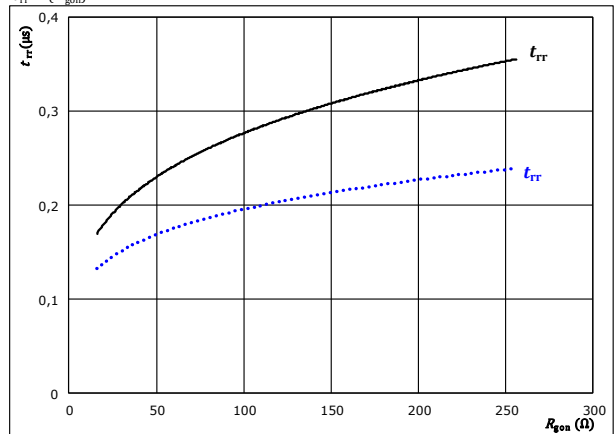

With an inductive load at

$V_{CE} = 400$ V
 $V_{GE} = \pm 15$ V
 $I_C = 6$ A

T_j : 25 °C (dotted)
 125 °C (solid)



Inverter Switching Characteristics

figure 9. FWD

Typical recovered charge as a function of collector current

$$Q_r = f(I_c)$$

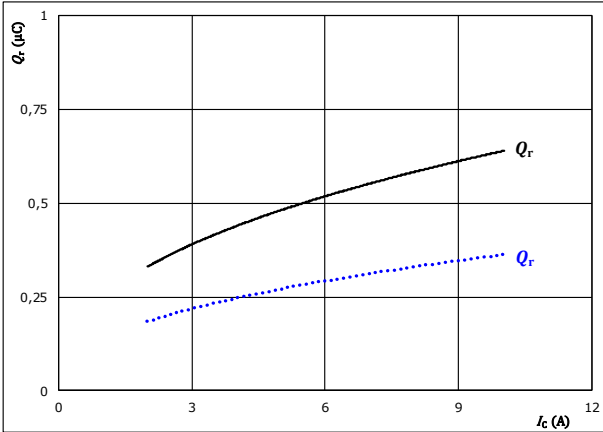

With an inductive load at $T_j: 25\text{ °C}$
 $V_{CE} = 400\text{ V}$
 $V_{GE} = \pm 15\text{ V}$
 $R_{gon} = 64\ \Omega$

figure 10. FWD

Typical recovered charge as a function of IGBT turn on gate resistor

$$Q_r = f(R_{gon})$$

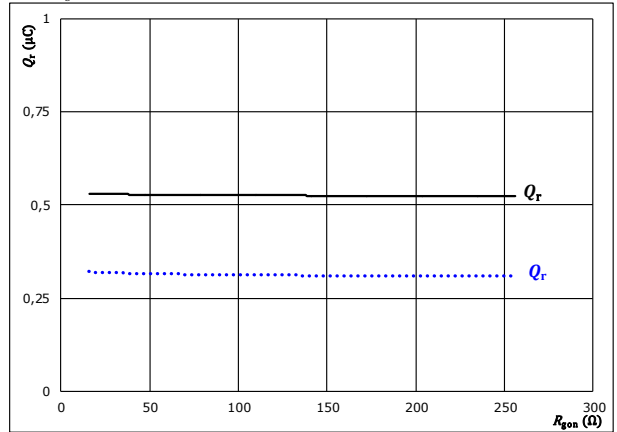

With an inductive load at $T_j: 25\text{ °C}$
 $V_{CE} = 400\text{ V}$
 $V_{GE} = \pm 15\text{ V}$
 $I_c = 6\text{ A}$

figure 11. FWD

Typical peak reverse recovery current current as a function of collector current

$$I_{RM} = f(I_c)$$

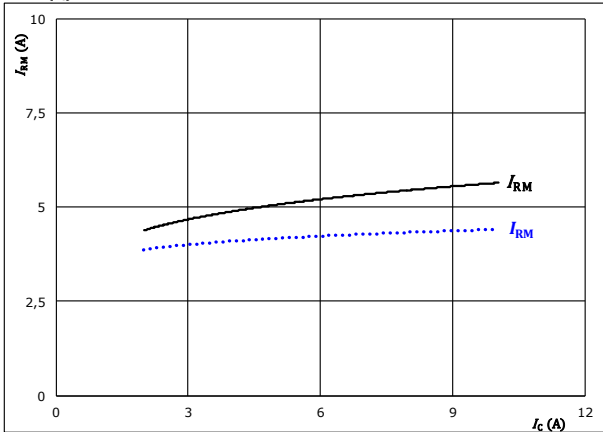

With an inductive load at $T_j: 25\text{ °C}$
 $V_{CE} = 400\text{ V}$
 $V_{GE} = \pm 15\text{ V}$
 $R_{gon} = 64\ \Omega$

figure 12. FWD

Typical peak reverse recovery current as a function of IGBT turn on gate resistor

$$I_{RM} = f(R_{gon})$$

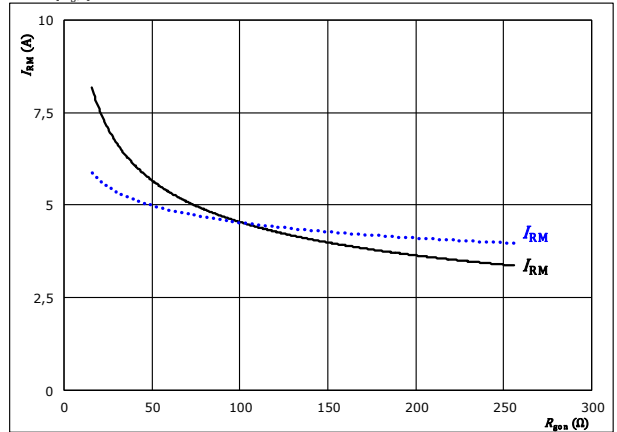

With an inductive load at $T_j: 25\text{ °C}$
 $V_{CE} = 400\text{ V}$
 $V_{GE} = \pm 15\text{ V}$
 $I_c = 6\text{ A}$



Inverter Switching Characteristics

figure 13. FWD

Typical rate of fall of forward and reverse recovery current as a function of collector current
 $di_f/dt, di_{rr}/dt = f(I_c)$

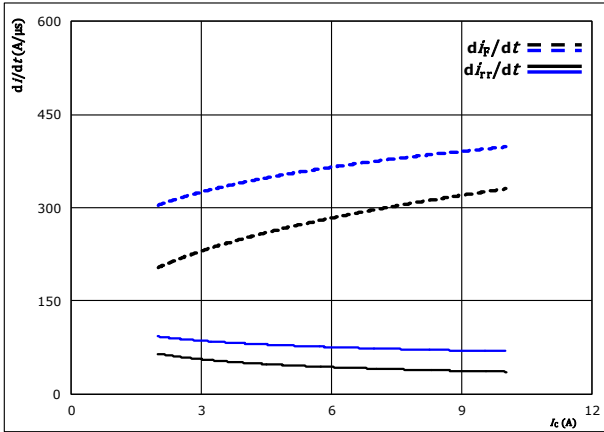

With an inductive load at $T_j = 25\text{ °C}$
 $V_{CE} = 400\text{ V}$
 $V_{GE} = \pm 15\text{ V}$
 $R_{g\text{on}} = 64\ \Omega$

figure 14. FWD

Typical rate of fall of forward and reverse recovery current as a function of IGBT turn on gate resistor
 $di_f/dt, di_{rr}/dt = f(R_{g\text{on}})$

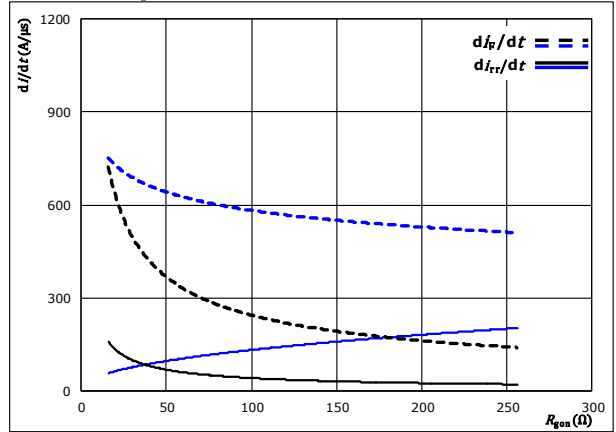

With an inductive load at $T_j = 25\text{ °C}$
 $V_{CE} = 400\text{ V}$
 $V_{GE} = \pm 15\text{ V}$
 $I_c = 6\text{ A}$

figure 15. IGBT

Reverse bias safe operating area
 $I_c = f(V_{CE})$

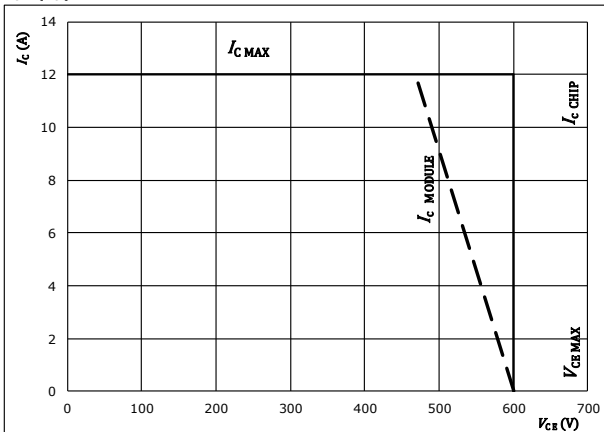

At $T_j = 125\text{ °C}$
 $R_{g\text{on}} = 64\ \Omega$
 $R_{g\text{off}} = 64\ \Omega$



Inverter Switching Definitions

General conditions		
T_j	=	125 °C
R_{gon}	=	64 Ω
R_{goff}	=	64 Ω

figure 1. IGBT

Turn-off Switching Waveforms & definition of t_{doff} , t_{Eoff} (t_{Eoff} = integrating time for E_{off})

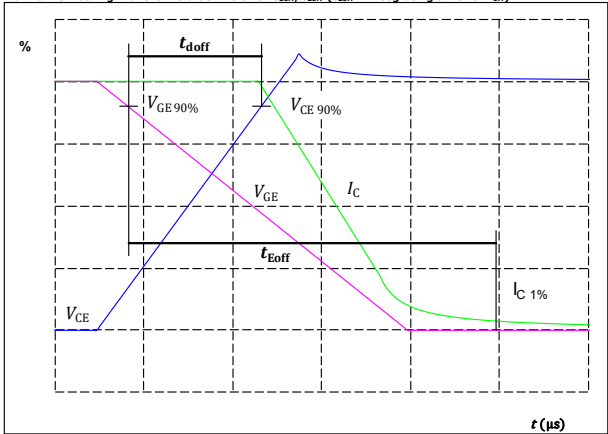

$V_{CE}(0\%) =$	-15	V
$V_{GE}(100\%) =$	15	V
$V_C(100\%) =$	400	V
$I_C(100\%) =$	6	A
$t_{doff} =$	127	ns

figure 2. IGBT

Turn-on Switching Waveforms & definition of t_{don} , t_{Eon} (t_{Eon} = integrating time for E_{on})

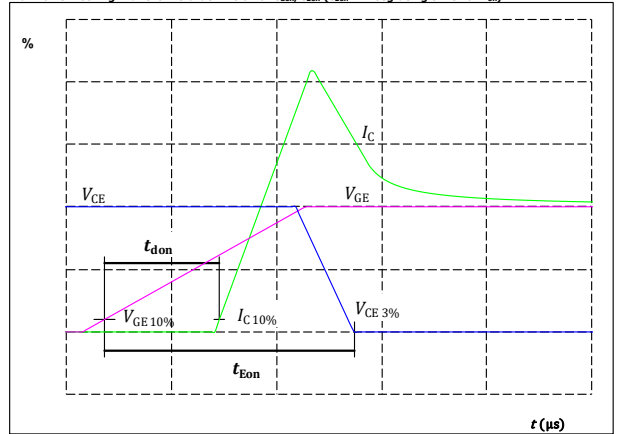

$V_{CE}(0\%) =$	-15	V
$V_{GE}(100\%) =$	15	V
$V_C(100\%) =$	400	V
$I_C(100\%) =$	6	A
$t_{don} =$	102	ns

figure 3. IGBT

Turn-off Switching Waveforms & definition of t_f

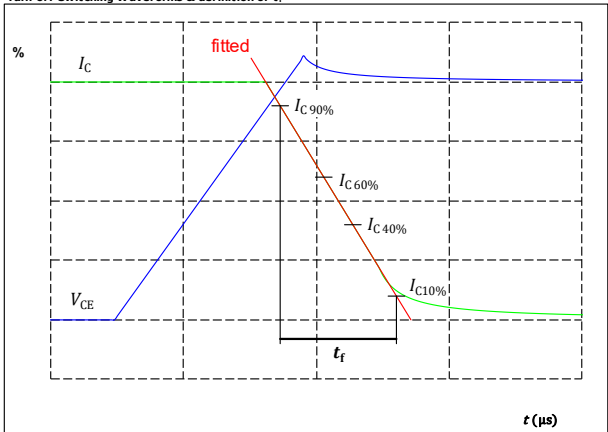

$V_C(100\%) =$	400	V
$I_C(100\%) =$	6	A
$t_f =$	50	ns

figure 4. IGBT

Turn-on Switching Waveforms & definition of t_r

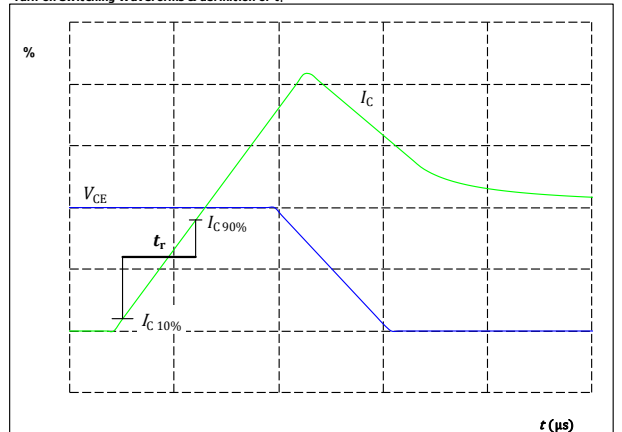

$V_C(100\%) =$	400	V
$I_C(100\%) =$	6	A
$t_r =$	22	ns



Vincotech

Inverter Switching Characteristics

figure 5. FWD

Turn-off Switching Waveforms & definition of t_{rr}

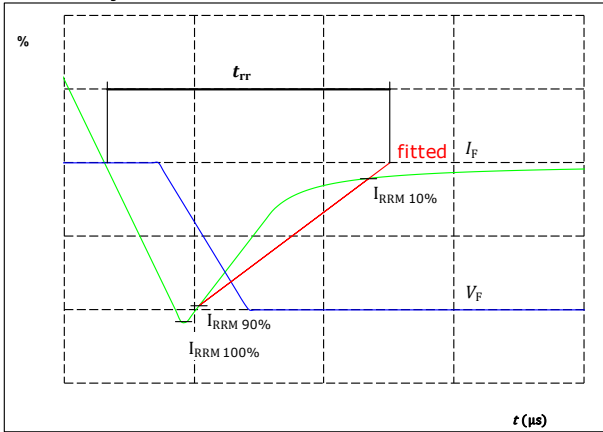

$V_F(100\%) =$	400	V
$I_F(100\%) =$	6	A
$I_{RRM}(100\%) =$	5	A
$t_{rr} =$	235	ns

figure 6. FWD

Turn-on Switching Waveforms & definition of t_{Qr} ($t_{Qr} =$ integrating time for Q_r)

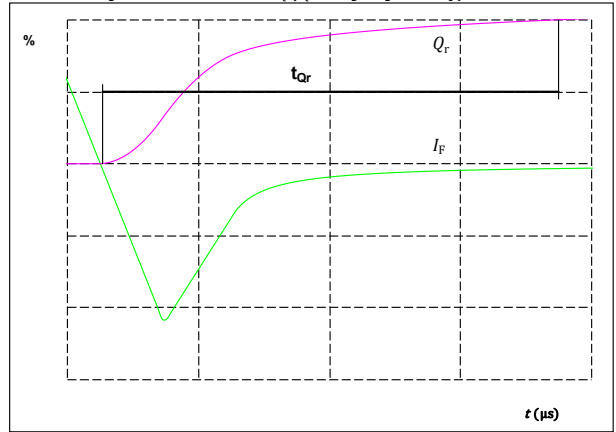

$I_F(100\%) =$	6	A
$Q_r(100\%) =$	0,531	μC



PFC Switching Characteristics

figure 1. IGBT

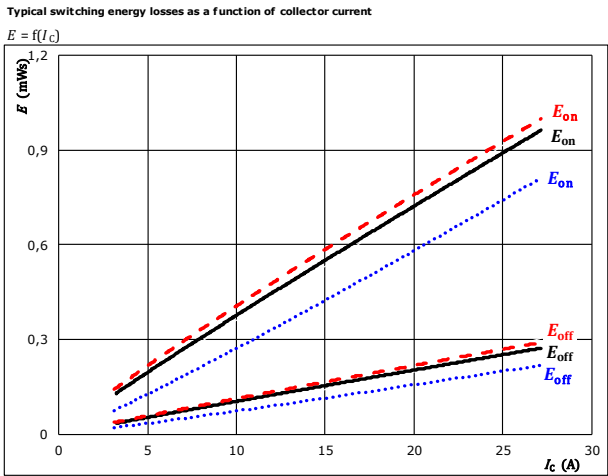

With an inductive load at

$V_{CE} = 400$ V	$T_j: 25$ °C
$V_{GE} = 0 / 15$ V	125 °C	————
$R_{g\text{on}} = 32$ Ω	150 °C	-----
$R_{g\text{off}} = 32$ Ω		

figure 2. IGBT

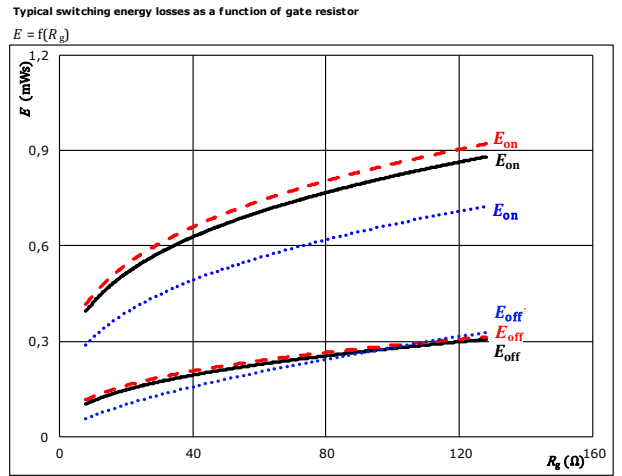

With an inductive load at

$V_{CE} = 400$ V	$T_j: 25$ °C
$V_{GE} = 0 / 15$ V	125 °C	————
$I_c = 15$ A	150 °C	-----

figure 3. FWD

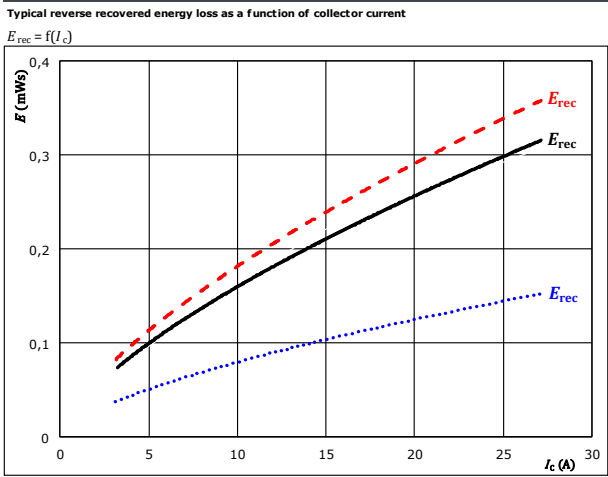

With an inductive load at

$V_{CE} = 400$ V	$T_j: 25$ °C
$V_{GE} = 0 / 15$ V	125 °C	————
$R_{g\text{on}} = 32$ Ω	150 °C	-----

figure 4. FWD

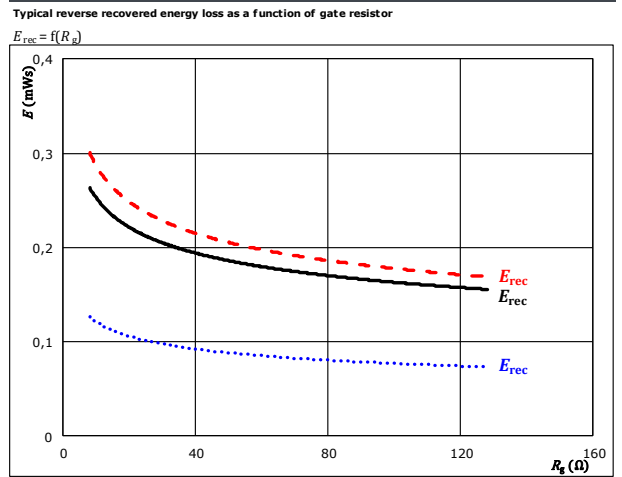

With an inductive load at

$V_{CE} = 400$ V	$T_j: 25$ °C
$V_{GE} = 0 / 15$ V	125 °C	————
$I_c = 15$ A	150 °C	-----



PFC Switching Characteristics

figure 5. IGBT

Typical switching times as a function of collector current

$$t = f(I_C)$$

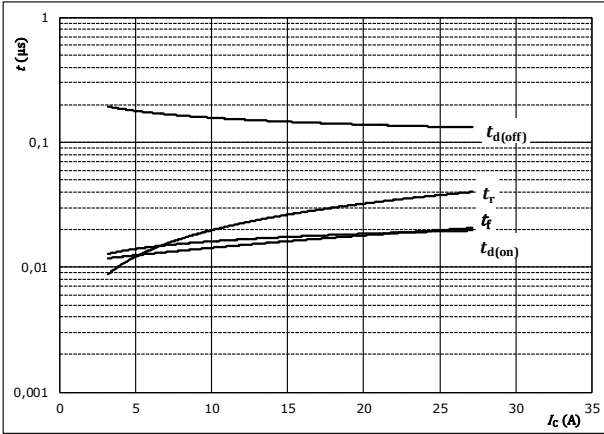

With an inductive load at

- $T_j = 150$ °C
- $V_{CE} = 400$ V
- $V_{GE} = 0 / 15$ V
- $R_{g(on)} = 32$ Ω
- $R_{g(off)} = 32$ Ω

figure 6. IGBT

Typical switching times as a function of gate resistor

$$t = f(R_g)$$

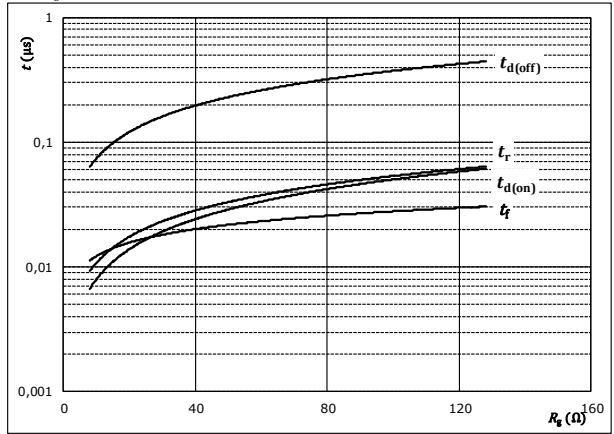

With an inductive load at

- $T_j = 150$ °C
- $V_{CE} = 400$ V
- $V_{GE} = 0 / 15$ V
- $I_C = 15$ A

figure 7. FWD

Typical reverse recovery time as a function of collector current

$$t_{rr} = f(I_C)$$

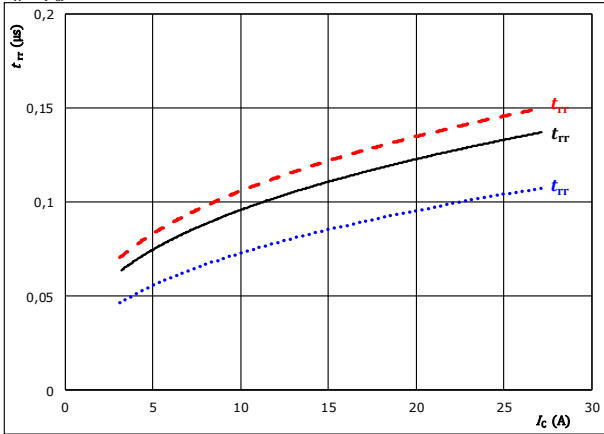

With an inductive load at

- $V_{CE} = 400$ V
- $V_{GE} = 0 / 15$ V
- $R_{g(on)} = 32$ Ω

- $T_j: 25$ °C (dotted line)
- 125 °C (solid line)
- 150 °C (dashed line)

figure 8. FWD

Typical reverse recovery time as a function of IGBT turn on gate resistor

$$t_{rr} = f(R_{g(on)})$$

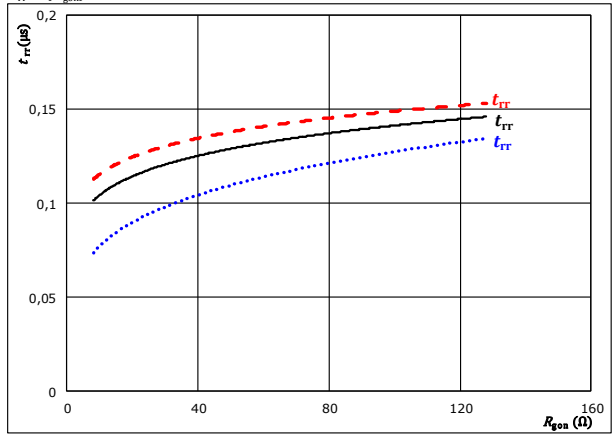

With an inductive load at

- $V_{CE} = 400$ V
- $V_{GE} = 0 / 15$ V
- $I_C = 15$ A

- $T_j: 25$ °C (dotted line)
- 125 °C (solid line)
- 150 °C (dashed line)



PFC Switching Characteristics

figure 9. FWD

Typical recovered charge as a function of collector current

$$Q_r = f(I_c)$$

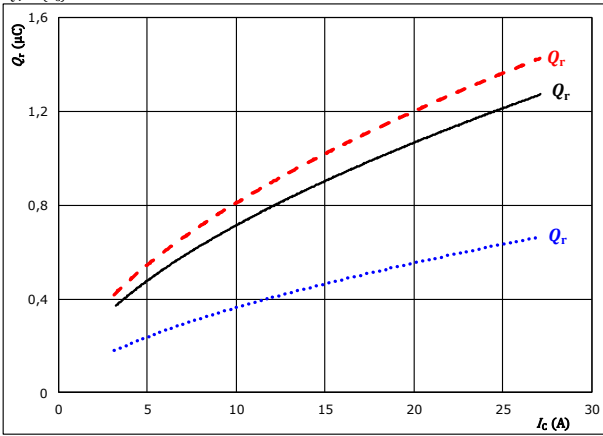

With an inductive load at
 $V_{CE} = 400$ V
 $V_{GE} = 0 / 15$ V
 $R_{gon} = 32$ Ω
 T_j : 25 °C (blue dotted), 125 °C (black solid), 150 °C (red dashed)

figure 10. FWD

Typical recovered charge as a function of IGBT turn on gate resistor

$$Q_r = f(R_{gon})$$

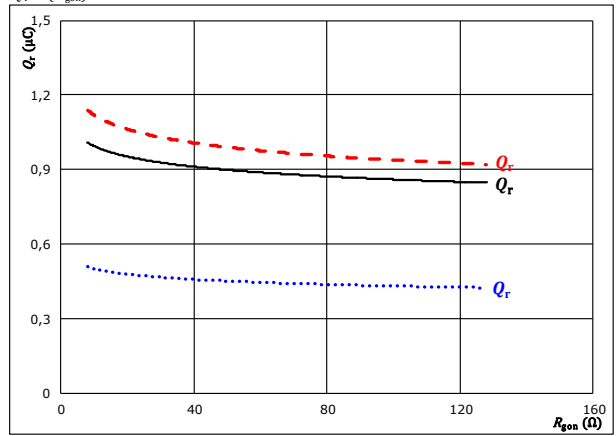

With an inductive load at
 $V_{CE} = 400$ V
 $V_{GE} = 0 / 15$ V
 $I_c = 15$ A
 T_j : 25 °C (blue dotted), 125 °C (black solid), 150 °C (red dashed)

figure 11. FWD

Typical peak reverse recovery current current as a function of collector current

$$I_{RM} = f(I_c)$$

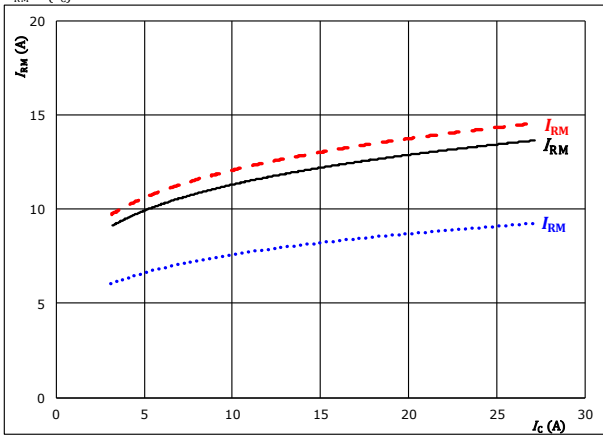

With an inductive load at
 $V_{CE} = 400$ V
 $V_{GE} = 0 / 15$ V
 $R_{gon} = 32$ Ω
 T_j : 25 °C (blue dotted), 125 °C (black solid), 150 °C (red dashed)

figure 12. FWD

Typical peak reverse recovery current as a function of IGBT turn on gate resistor

$$I_{RM} = f(R_{gon})$$

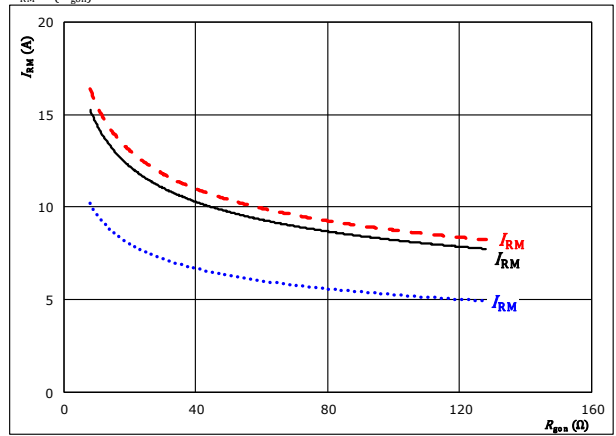

With an inductive load at
 $V_{CE} = 400$ V
 $V_{GE} = 0 / 15$ V
 $I_c = 15$ A
 T_j : 25 °C (blue dotted), 125 °C (black solid), 150 °C (red dashed)



PFC Switching Characteristics

figure 13. FWD

Typical rate of fall of forward and reverse recovery current as a function of collector current
 $di_f/dt, di_{rr}/dt = f(I_c)$

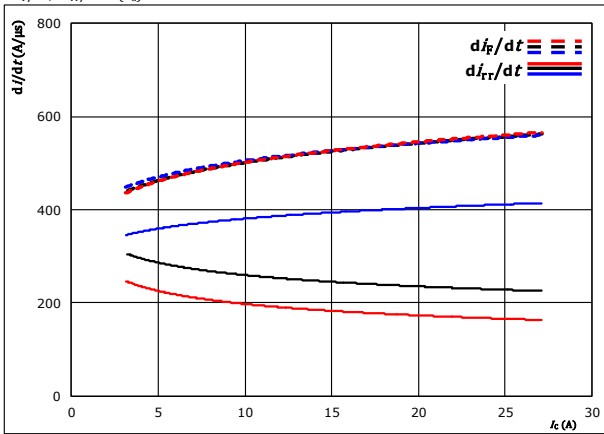

With an inductive load at
 $V_{CE} = 400 \text{ V}$
 $V_{GE} = 0 / 15 \text{ V}$
 $R_{g\text{on}} = 32 \text{ } \Omega$
 $T_j = 25 \text{ } ^\circ\text{C}$
 $125 \text{ } ^\circ\text{C}$
 $150 \text{ } ^\circ\text{C}$

figure 14. FWD

Typical rate of fall of forward and reverse recovery current as a function of IGBT turn on gate resistor
 $di_f/dt, di_{rr}/dt = f(R_{g\text{on}})$

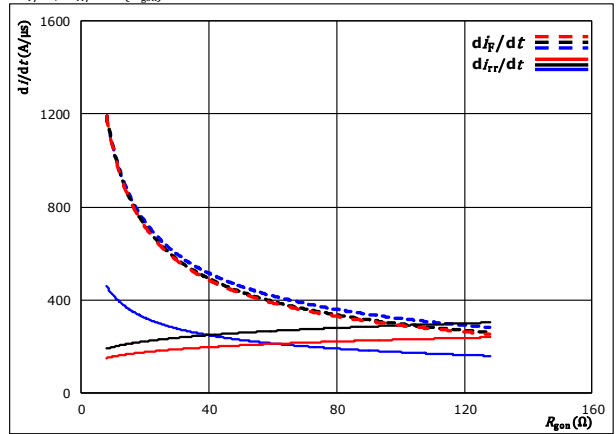

With an inductive load at
 $V_{CE} = 400 \text{ V}$
 $V_{GE} = 0 / 15 \text{ V}$
 $I_c = 15 \text{ A}$
 $T_j = 25 \text{ } ^\circ\text{C}$
 $125 \text{ } ^\circ\text{C}$
 $150 \text{ } ^\circ\text{C}$

figure 15. IGBT

Reverse bias safe operating area
 $I_c = f(V_{CE})$

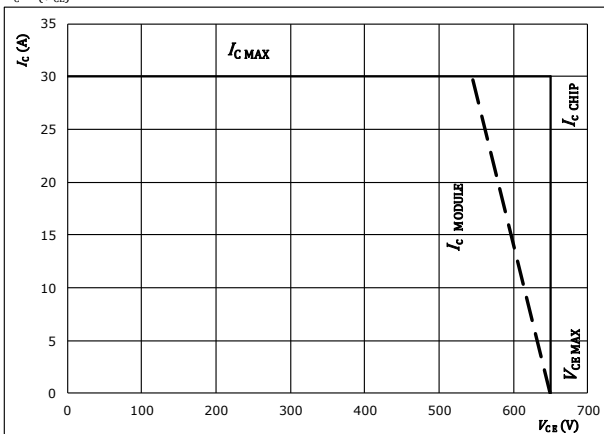

At
 $T_j = 125 \text{ } ^\circ\text{C}$
 $R_{g\text{on}} = 32 \text{ } \Omega$
 $R_{g\text{off}} = 32 \text{ } \Omega$



PFC Switching Definitions

General conditions		
T_j	=	125 °C
R_{gon}	=	32 Ω
R_{goff}	=	32 Ω

figure 1. IGBT

Turn-off Switching Waveforms & definition of t_{doff} , t_{Eoff} (t_{Eoff} = integrating time for E_{off})

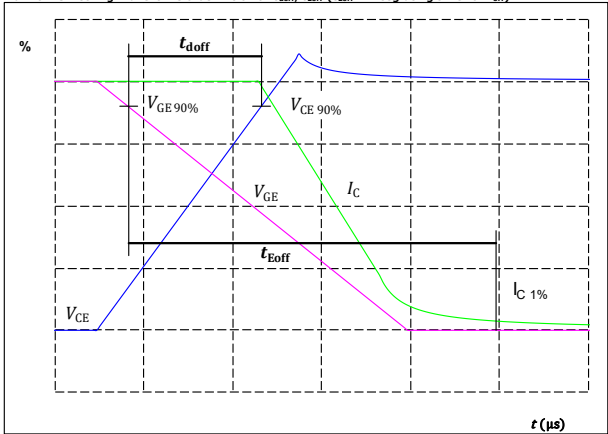

$V_{CE}(0\%) =$	0	V
$V_{GE}(100\%) =$	15	V
$V_C(100\%) =$	400	V
$I_C(100\%) =$	15	A
$t_{doff} =$	141	ns

figure 2. IGBT

Turn-on Switching Waveforms & definition of t_{don} , t_{Eon} (t_{Eon} = integrating time for E_{on})

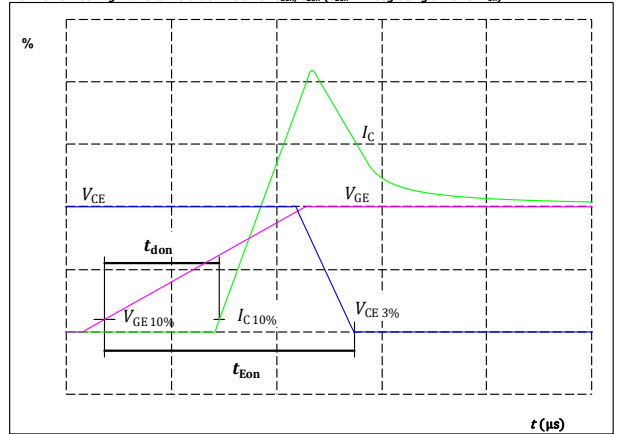

$V_{CE}(0\%) =$	0	V
$V_{GE}(100\%) =$	15	V
$V_C(100\%) =$	400	V
$I_C(100\%) =$	15	A
$t_{don} =$	17	ns

figure 3. IGBT

Turn-off Switching Waveforms & definition of t_f

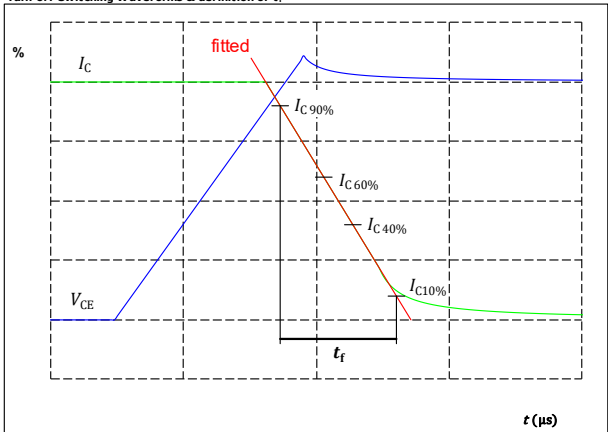

$V_C(100\%) =$	400	V
$I_C(100\%) =$	15	A
$t_f =$	14	ns

figure 4. IGBT

Turn-on Switching Waveforms & definition of t_r

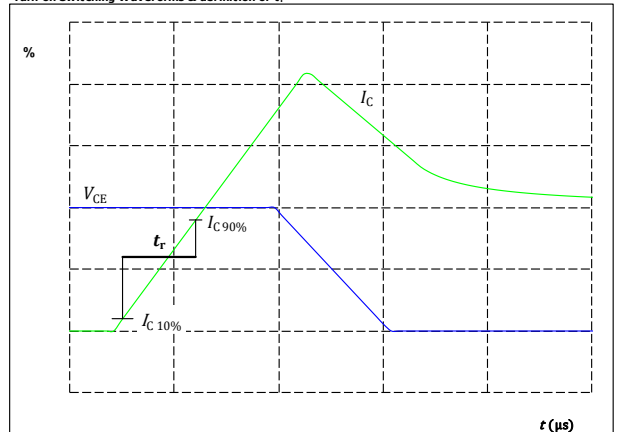

$V_C(100\%) =$	400	V
$I_C(100\%) =$	15	A
$t_r =$	26	ns



Vincotech

PFC Switching Characteristics

figure 5. FWD

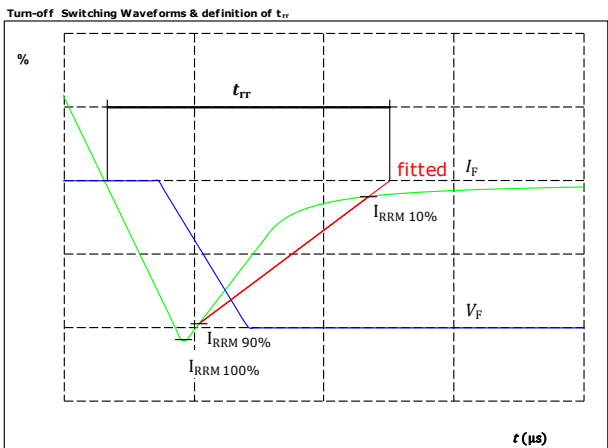

$V_F(100\%) =$	400	V
$I_F(100\%) =$	15	A
$I_{RRM}(100\%) =$	12	A
$t_{rr} =$	114	ns

figure 6. FWD

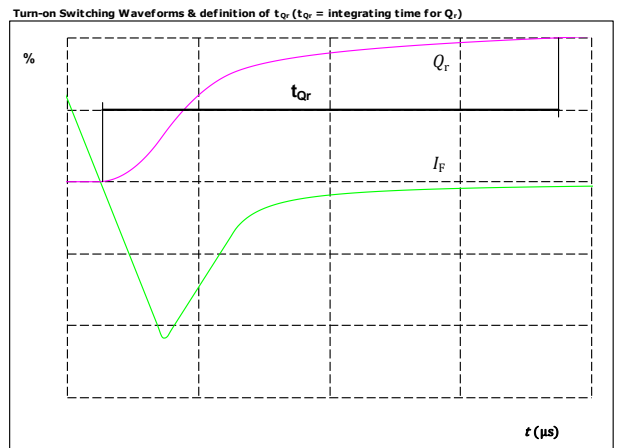

$I_F(100\%) =$	15	A
$Q_r(100\%) =$	0	μC



Vincotech

Ordering Code & Marking								
Version			Ordering Code					
without thermal paste 17mm housing with solder pins			10-0B06PPA006RC-L023A09					
with thermal paste 17mm housing with solder pins			10-0B06PPA006RC-L023A09-/3/					
NN-NNNNNNNN NNNN-TTTTTTVV VIN LLLLL WWYY SSSS UL			Text	Name	Type&Ver	Date code	VIN & Lot	Serial&UL
				NN-NNNNNNNNNNNNNN	TTTTTTTVV	WWYY	VIN LLLLL	SSSS UL
			Datamatrix	Type&Ver	Lot number	Serial	Date code	
				TTTTTTTVV	LLLLL	SSSS	WWYY	

Pin table			
Pin	X	Y	Function
1	24,7	0	DC-Rect
2	21,7	0	DC-PFC
3	18,7	0	G27
4	15	0	DC-3
5	12	0	G15
6	9	0	DC-2
7	6	0	G13
8	3	0	DC-1
9	0	0	G11
10	0	3	Therm2
11	0	5,8	Therm1
12	0	10,8	G12
13	0	13,8	Ph1
14	5,7	13,8	G14
15	8,7	13,8	Ph2
16	14,4	13,8	Ph3
17	14,4	10,8	G16
18	19,7	9,3	DC+
19	22,9	13,8	PFC
20	27,9	13,8	ACIn1
21	27,9	6,95	ACIn2
22	23,05	6,95	DC+Rect

Tolerance of pinpositions: $\pm 0,5\text{mm}$ at the end of pins
 Dimension of coordinate axis is only offset without tolerance



Vincotech

Pinout

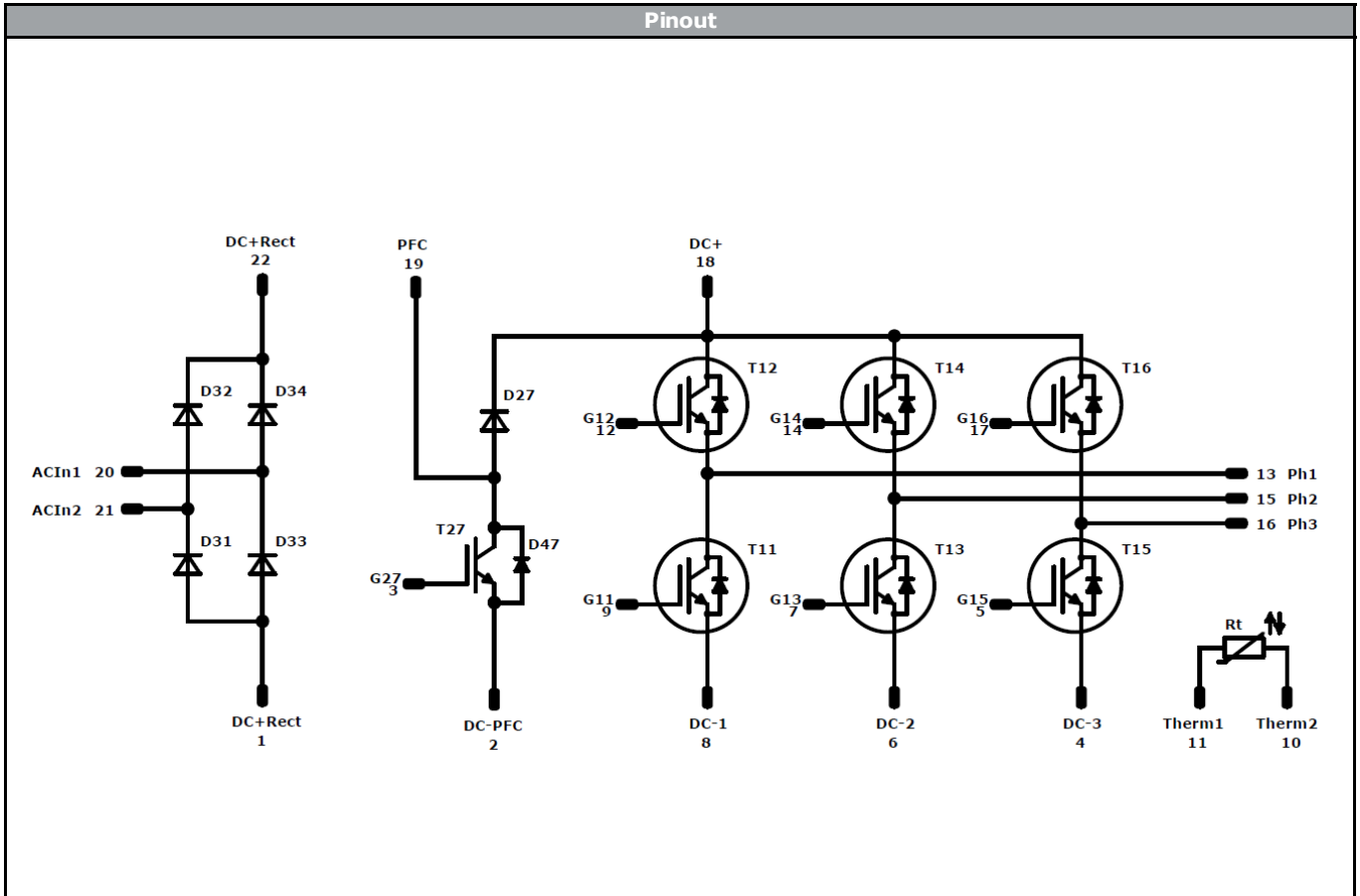

Identification

ID	Component	Voltage	Current	Function	Comment
D31, D32, D33, D34	Rectifier	1600 V	13 A	Rectifier Diode	
T11, T12, T13, T14, T15, T16	RC-IGBT	600 V	6 A	Inverter Switch	
T27	IGBT	650 V	15 A	PFC Switch	
D27	FWD	650 V	15 A	PFC Diode	
D47	FWD	650 V	6 A	PFC Sw. Protection Diode	
Rt	NTC			Thermistor	



Vincotech

Packaging instruction			
Standard packaging quantity (SPQ) 160	>SPQ	Standard	<SPQ Sample

Handling instruction
Handling instructions for <i>flow0</i> B packages see vincotech.com website.

Package data
Package data for <i>flow0</i> B packages see vincotech.com website.

UL recognition and file number
This device is certified according to UL 1557 standard, UL file number E192116. For more information see vincotech.com website. 

Document No.:	Date:	Modification:	Pages
10-0B06PPA006RC-L023A09-D4-14	27 Mar. 2019	PCN implementation: IFX Rapid1-> Rapid1Solar PCN implementation: Tateyama NTC	6,7,15,23-28 8,16

DISCLAIMER

The information, specifications, procedures, methods and recommendations herein (together "information") are presented by Vincotech to reader in good faith, are believed to be accurate and reliable, but may well be incomplete and/or not applicable to all conditions or situations that may exist or occur. Vincotech reserves the right to make any changes without further notice to any products to improve reliability, function or design. No representation, guarantee or warranty is made to reader as to the accuracy, reliability or completeness of said information or that the application or use of any of the same will avoid hazards, accidents, losses, damages or injury of any kind to persons or property or that the same will not infringe third parties rights or give desired results. It is reader's sole responsibility to test and determine the suitability of the information and the product for reader's intended use.

LIFE SUPPORT POLICY

Vincotech products are not authorised for use as critical components in life support devices or systems without the express written approval of Vincotech.

As used herein:

1. Life support devices or systems are devices or systems which, (a) are intended for surgical implant into the body, or (b) support or sustain life, or (c) whose failure to perform when properly used in accordance with instructions for use provided in labelling can be reasonably expected to result in significant injury to the user.
2. A critical component is any component of a life support device or system whose failure to perform can be reasonably expected to cause the failure of the life support device or system, or to affect its safety or effectiveness.