

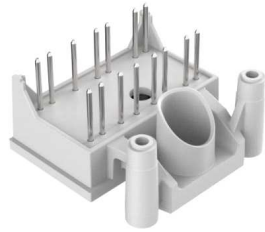
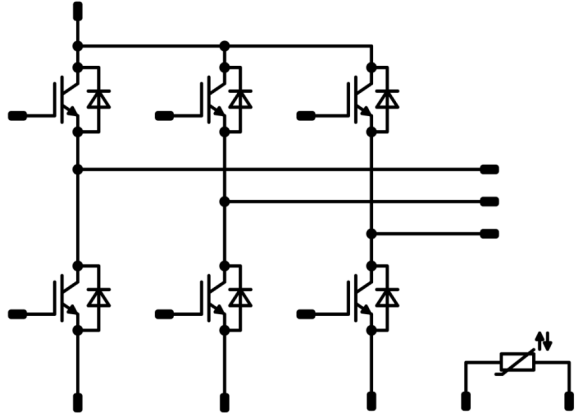

Vincotech

flow PACK 0 B	600 V / 15 A
<div style="border: 1px solid black; padding: 5px; margin-bottom: 5px;"> <p style="text-align: center; background-color: #cccccc; margin: 0;">Features</p> <ul style="list-style-type: none"> IGBT3 (600 V) technology Open emitter topology New ultra-compact housing Single-screw heat sink mounting </div> <div style="border: 1px solid black; padding: 5px; margin-bottom: 5px;"> <p style="text-align: center; background-color: #cccccc; margin: 0;">Target applications</p> <ul style="list-style-type: none"> Dedicated design for motor drive </div> <div style="border: 1px solid black; padding: 5px;"> <p style="text-align: center; background-color: #cccccc; margin: 0;">Types</p> <ul style="list-style-type: none"> 10-0B066PA015SB-M994F09 </div>	<div style="border: 1px solid black; padding: 5px; margin-bottom: 5px;"> <p style="text-align: center; background-color: #cccccc; margin: 0;">flow 0 B 17mm housing</p>  </div> <div style="border: 1px solid black; padding: 5px;"> <p style="text-align: center; background-color: #cccccc; margin: 0;">Schematic</p>  </div>

Maximum Ratings

$T_j = 25\text{ }^\circ\text{C}$, unless otherwise specified

Parameter	Symbol	Condition	Value	Unit
Inverter Switch				
Collector-emitter voltage	V_{CES}		600	V
Collector current	I_C	$T_j = T_{jmax}$ $T_s = 80\text{ }^\circ\text{C}$	18	A
Repetitive peak collector current	I_{CRM}	t_p limited by T_{jmax}	45	A
Total power dissipation	P_{tot}	$T_j = T_{jmax}$ $T_s = 80\text{ }^\circ\text{C}$	40	W
Gate-emitter voltage	V_{GES}		± 20	V
Short circuit ratings	t_{SC} V_{CC}	$T_j \leq 150\text{ }^\circ\text{C}$ $V_{GE} = 15\text{V}$	6 360	μs V
Maximum Junction Temperature	T_{jmax}		175	$^\circ\text{C}$



Vincotech

Parameter	Symbol	Condition	Value	Unit
Inverter Diode				
Peak Repetitive Reverse Voltage	V_{RRM}		600	V
Continuous (direct) forward current	I_F	$T_j = T_{jmax}$ $T_s = 80\text{ °C}$	19	A
Repetitive peak forward current	I_{FRM}		30	A
Total power dissipation	P_{tot}	$T_j = T_{jmax}$ $T_s = 80\text{ °C}$	31	W
Maximum Junction Temperature	T_{jmax}		175	°C
Module Properties				
Thermal Properties				
Storage temperature	T_{stg}		-40...+125	°C
Operation temperature under switching condition	T_{jop}		-40...+($T_{jmax} - 25$)	°C
Isolation Properties				
Isolation voltage	V_{isol}	DC Voltage $t_p = 2s$	4000	V
Creepage distance			min. 12,7	mm
Clearance			min. 12,7	mm
Comparative Tracking Index	CTI		> 200	



Vincotech

Characteristic Values

Parameter	Symbol	Conditions					Value			Unit
		V_{GE} [V] V_{GS} [V]	V_{CE} [V] V_{GS} [V] V_r [V]	I_C [A] I_D [A] I_F [A]	T_j [°C]	Min	Typ	Max		

Inverter Switch

Static

Gate-emitter threshold voltage	$V_{GE(th)}$	$V_{GE} = V_{CE}$			0,00021	25 125	5	5,8	6,5	V
Collector-emitter saturation voltage	V_{CESat}		15		15	25 150	1,1	1,59 1,85	1,9	V
Collector-emitter cut-off current	I_{CES}		0	600		25 125			0,85	μA
Gate-emitter leakage current	I_{GES}		20	0		25 125			300	nA
Internal gate resistance	r_g							none		Ω
Input capacitance	C_{ies}	f = 1 MHz	0	25		25		860		pF
Output capacitance	C_{oes}							55		
Reverse transfer capacitance	C_{res}							24		
Gate charge	Q_g		15	480	15	25		87		nC

Thermal

Thermal resistance junction to sink	$R_{th(j-s)}$	Thermal grease thickness $\leq 50 \mu\text{m}$ $\lambda = 1 \text{ W/mK}$						2,40		K/W
-------------------------------------	---------------	--	--	--	--	--	--	------	--	-----

IGBT Switching

Turn-on delay time	$t_{d(on)}$	$R_{goff} = 32 \Omega$ $R_{gon} = 32 \Omega$	±15	300	15	25		106		ns
Rise time	t_r					150		105		
Turn-off delay time	$t_{d(off)}$					25		15		
Fall time	t_f					150		18		
Turn-on energy (per pulse)	E_{on}	$Q_{rFWD} = 0,7 \mu\text{C}$ $Q_{rFWD} = 1,4 \mu\text{C}$				25		0,276		mWs
Turn-off energy (per pulse)	E_{off}					150		0,380		
						25		0,345		
						150		0,459		



Vincotech

Parameter	Symbol	Conditions					Value			Unit	
		V_{GE} [V]	V_{GS} [V]	V_{CE} [V]	V_{GS} [V]	V_r [V]	I_C [A]	I_D [A]	I_F [A]		T_j [°C]

Inverter Diode

Static

Forward voltage	V_F				15	25 150		1,60 1,51	1,95	V
Reverse leakage current	I_r			600		25			27	μ A

Thermal

Thermal resistance junction to sink	$R_{th(j-s)}$	Thermal grease thickness $\leq 50 \mu\text{m}$ $\lambda = 1 \text{ W/mK}$						3,10		K/W
-------------------------------------	---------------	--	--	--	--	--	--	------	--	-----

FWD Switching

Peak recovery current	I_{RRM}					25 150		11 16		A
Reverse recovery time	t_{rr}					25 150		180 272		ns
Recovered charge	Q_r	$di/dt = 1184 \text{ A}/\mu\text{s}$ $di/dt = 1026 \text{ A}/\mu\text{s}$	± 15	300	15	25 150		0,715 1,445		μC
Reverse recovered energy	E_{rec}					25 150		0,159 0,306		mWs
Peak rate of fall of recovery current	$(di_{rr}/dt)_{max}$					25 150		470 194		A/ μs

Thermistor

Rated resistance	R					25		21,5		k Ω
Deviation of R100	$\Delta_{R/R}$	R100=1486 Ω				100	-4,5		+4,5	%
Power dissipation	P					25		210		mW
Power dissipation constant						25		3,5		mW/K
B-value	$B_{(25/50)}$					25		3884		K
B-value	$B_{(25/100)}$					25		3964		K
Vincotech NTC Reference									F	



Inverter Switch Characteristics

Typical output characteristics IGBT

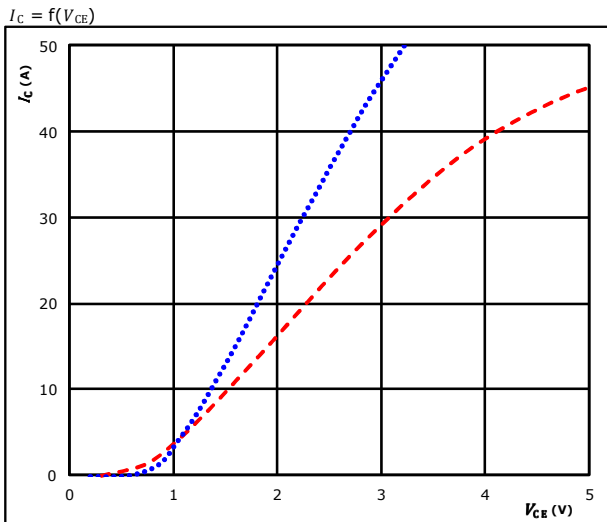

$t_p = 250 \mu s$
 $V_{GE} = 15 V$
 $T_j: 25 \text{ }^\circ\text{C}$ (blue dotted line)
 $150 \text{ }^\circ\text{C}$ (red dashed line)

Typical output characteristics IGBT

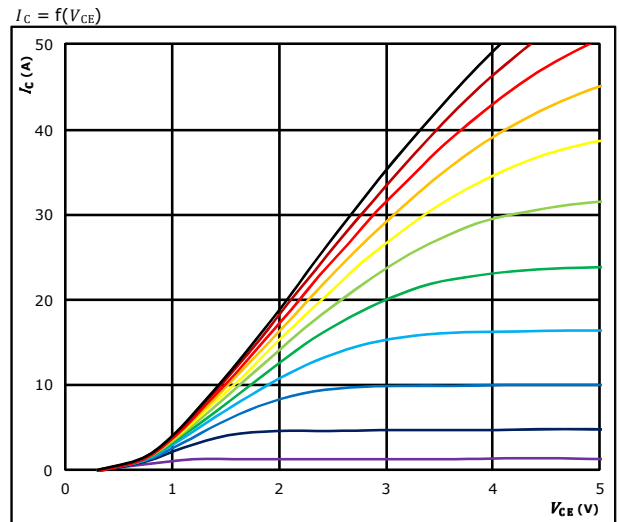

$t_p = 250 \mu s$
 $T_j = 150 \text{ }^\circ\text{C}$
 V_{CE} from 7 V to 17 V in steps of 1 V

Typical transfer characteristics IGBT

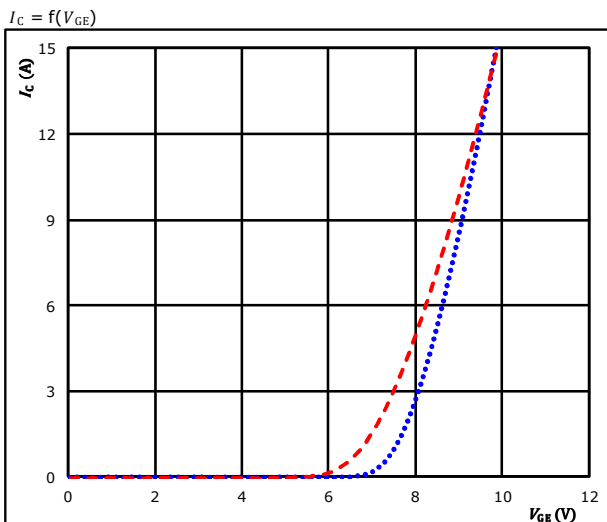

$t_p = 100 \mu s$
 $V_{CE} = 10 V$
 $T_j: 25 \text{ }^\circ\text{C}$ (blue dotted line)
 $150 \text{ }^\circ\text{C}$ (red dashed line)

Transient Thermal Impedance as function of Pulse duration IGBT

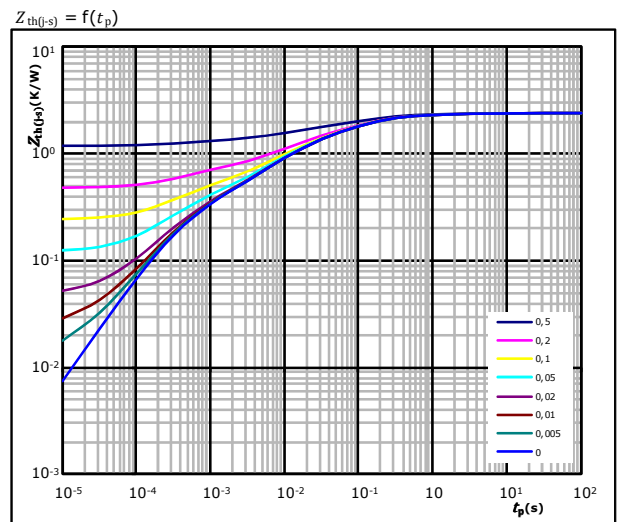

$D = t_p / T$
 $R_{th(j-s)} = 2,40 \text{ K/W}$

IGBT thermal model values

R (K/W)	τ (s)
4,32E-02	7,18E+00
2,14E-01	7,90E-01
8,50E-01	1,13E-01
7,21E-01	1,91E-02
3,38E-01	3,73E-03
2,33E-01	3,73E-04



Vincotech

Inverter Switch Characteristics

Gate voltage vs Gate charge IGBT

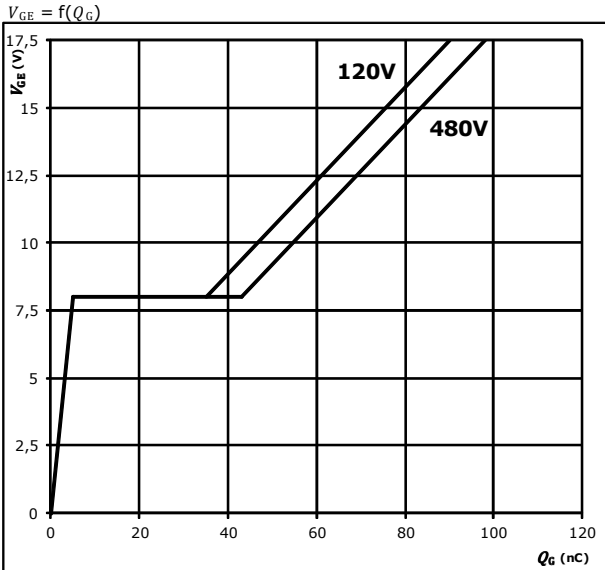

At
 $I_C = 15$ A

Short circuit duration as a function of V_{GE} IGBT

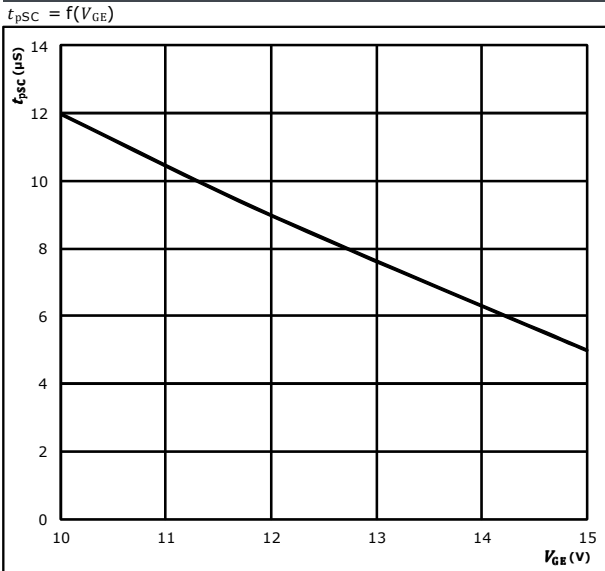

At
 $V_{CE} = 600$ V
 $T_j \leq 175$ °C

Typical short circuit current as a function of V_{GE} IGBT

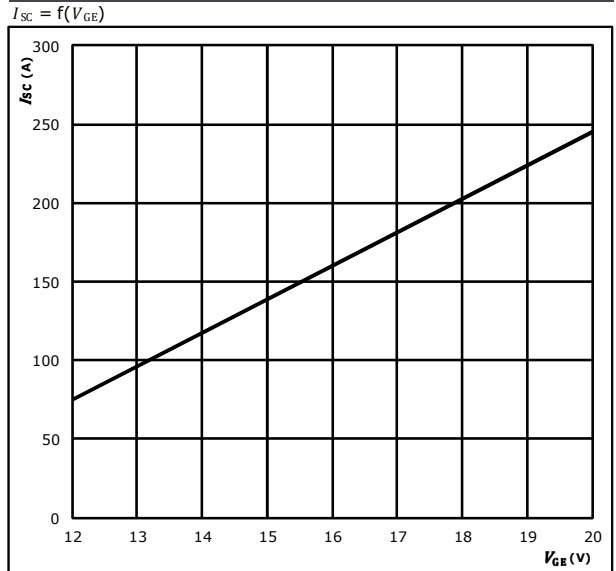

At
 $V_{CE} \leq 600$ V
 $T_j \leq 175$ °C



Vincotech

Inverter Diode Characteristics

Typical forward characteristics FWD

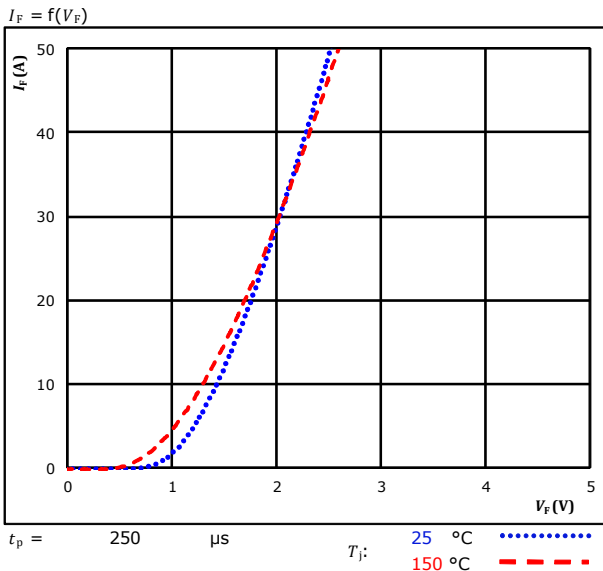

Transient thermal impedance as a function of pulse width FWD

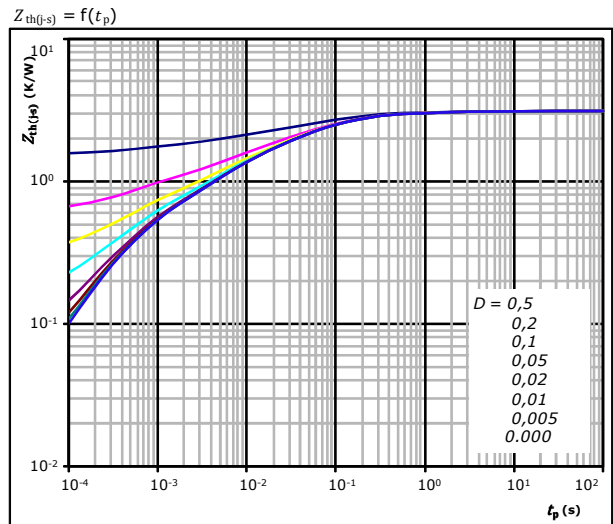

$D = t_p / T$
 $R_{th(j-s)} = 3,10 \text{ K/W}$

FWD thermal model values

R (K/W)	τ (s)
4,74E-02	7,04E+00
2,14E-01	7,72E-01
9,95E-01	1,01E-01
8,61E-01	2,15E-02
5,97E-01	3,79E-03
3,86E-01	4,43E-04

Thermistor

Thermistor typical temperature characteristic

Typical NTC characteristic
as a function of temperature

$R_T = f(T)$

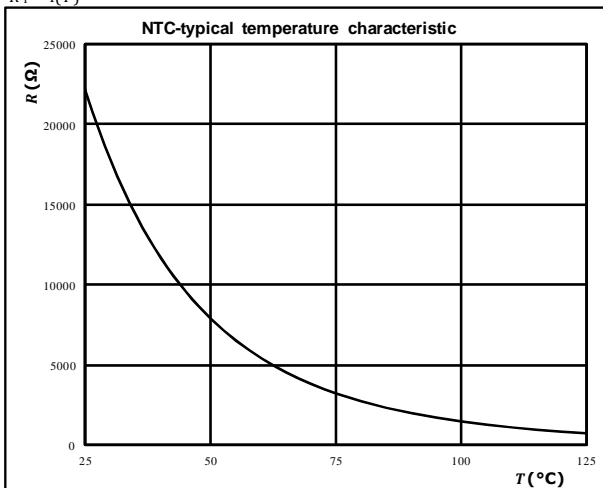



Inverter Switching Characteristics

figure 1. IGBT

Typical switching energy losses as a function of collector current

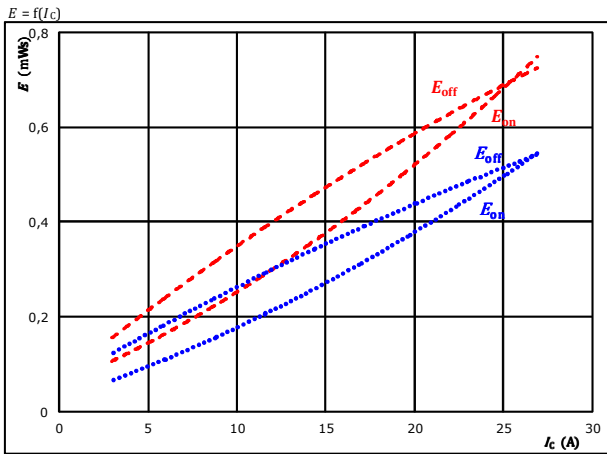

With an inductive load at

$V_{CE} = 300$ V	$T_j: 25$ °C
$V_{GE} = \pm 15$ V	$T_j: 150$ °C	-----
$R_{g\text{on}} = 32$ Ω		
$R_{g\text{off}} = 32$ Ω		

figure 2. IGBT

Typical switching energy losses as a function of gate resistor

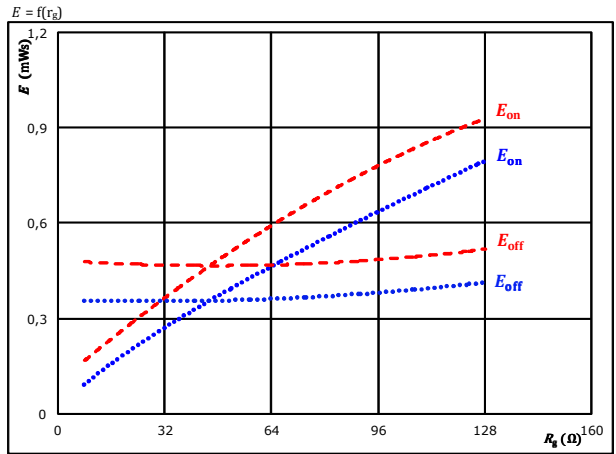

With an inductive load at

$V_{CE} = 300$ V	$T_j: 25$ °C
$V_{GE} = \pm 15$ V	$T_j: 150$ °C	-----
$I_C = 15$ A		

figure 3. FWD

Typical reverse recovered energy loss as a function of collector current

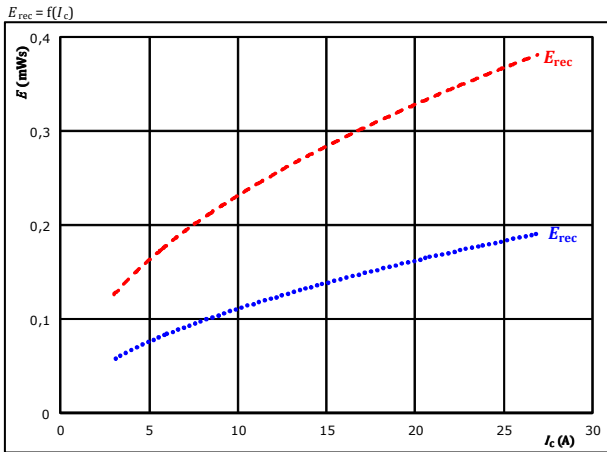

With an inductive load at

$V_{CE} = 300$ V	$T_j: 25$ °C
$V_{GE} = \pm 15$ V	$T_j: 150$ °C	-----
$R_{g\text{on}} = 32$ Ω		

figure 4. FWD

Typical reverse recovered energy loss as a function of gate resistor

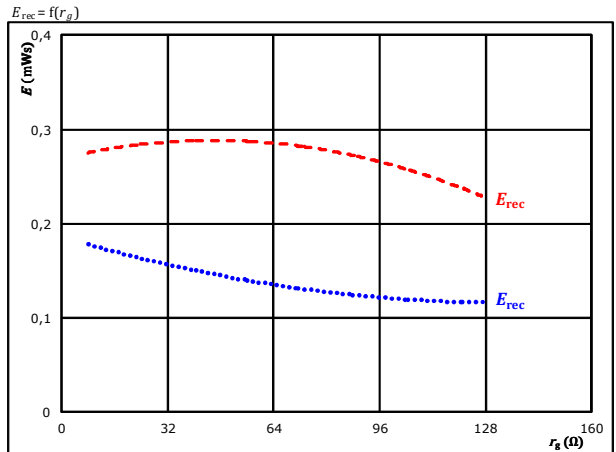

With an inductive load at

$V_{CE} = 300$ V	$T_j: 25$ °C
$V_{GE} = \pm 15$ V	$T_j: 150$ °C	-----
$I_C = 15$ A		



Inverter Switching Characteristics

figure 5. IGBT

Typical switching times as a function of collector current

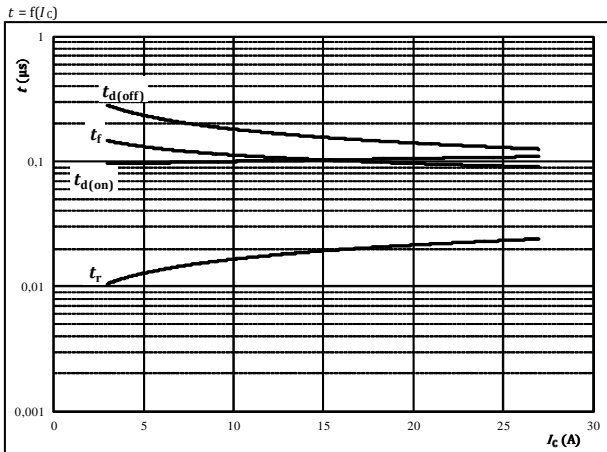

With an inductive load at

- $T_j = 150 \text{ }^\circ\text{C}$
- $V_{CE} = 300 \text{ V}$
- $V_{GE} = \pm 15 \text{ V}$
- $R_{g\text{on}} = 32 \text{ } \Omega$
- $R_{g\text{off}} = 32 \text{ } \Omega$

figure 6. IGBT

Typical switching times as a function of gate resistor

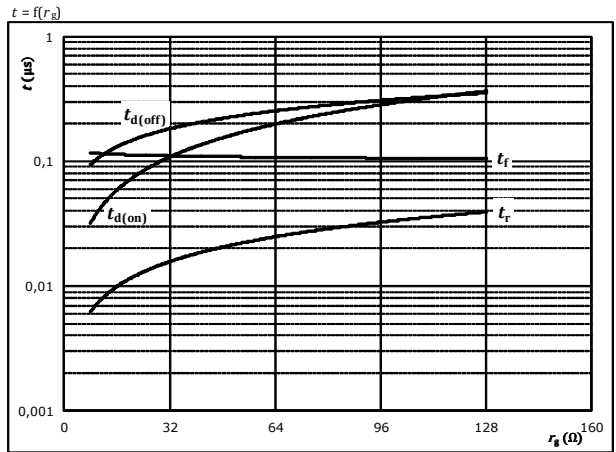

With an inductive load at

- $T_j = 150 \text{ }^\circ\text{C}$
- $V_{CE} = 300 \text{ V}$
- $V_{GE} = \pm 15 \text{ V}$
- $I_c = 15 \text{ A}$

figure 7. FWD

Typical reverse recovery time as a function of collector current

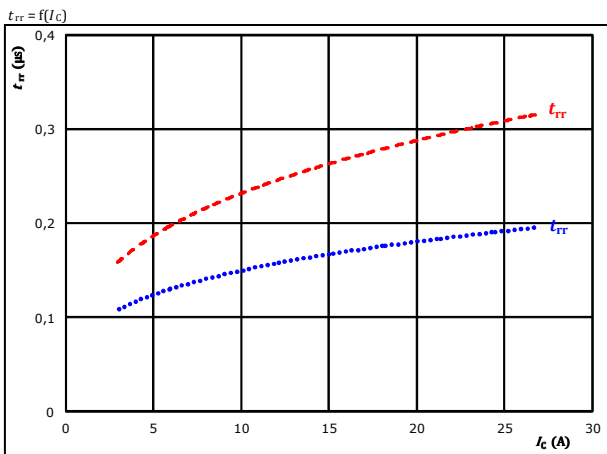

- At $V_{CE} = 300 \text{ V}$, $V_{GE} = \pm 15 \text{ V}$, $R_{g\text{on}} = 32 \text{ } \Omega$
- T_j : $25 \text{ }^\circ\text{C}$ (dotted blue line), $150 \text{ }^\circ\text{C}$ (dashed red line)

figure 8. FWD

Typical reverse recovery time as a function of IGBT turn on gate resistor

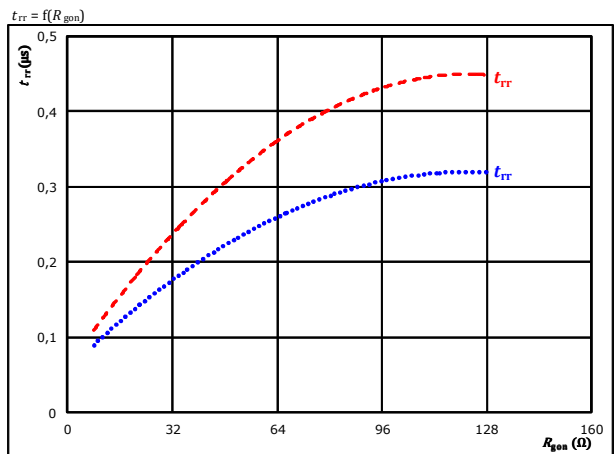

- At $V_{CE} = 300 \text{ V}$, $V_{GE} = \pm 15 \text{ V}$, $I_c = 15 \text{ A}$
- T_j : $25 \text{ }^\circ\text{C}$ (dotted blue line), $150 \text{ }^\circ\text{C}$ (dashed red line)



Inverter Switching Characteristics

figure 9. FWD
Typical recovered charge as a function of collector current

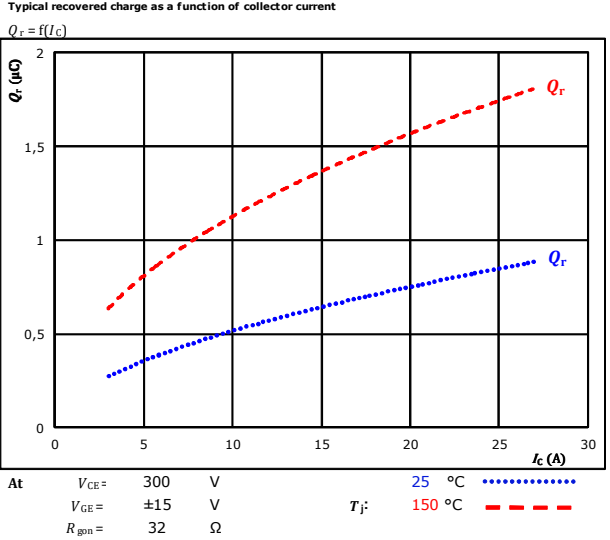

figure 10. FWD
Typical recovered charge as a function of IGBT turn on gate resistor

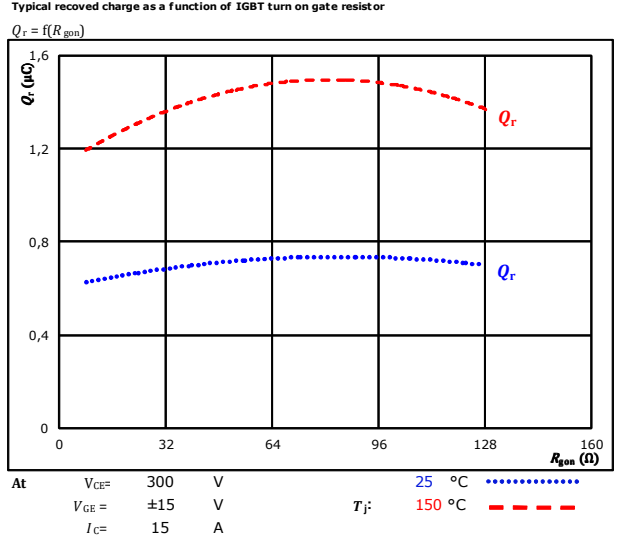

figure 11. FWD
Typical peak reverse recovery current as a function of collector current

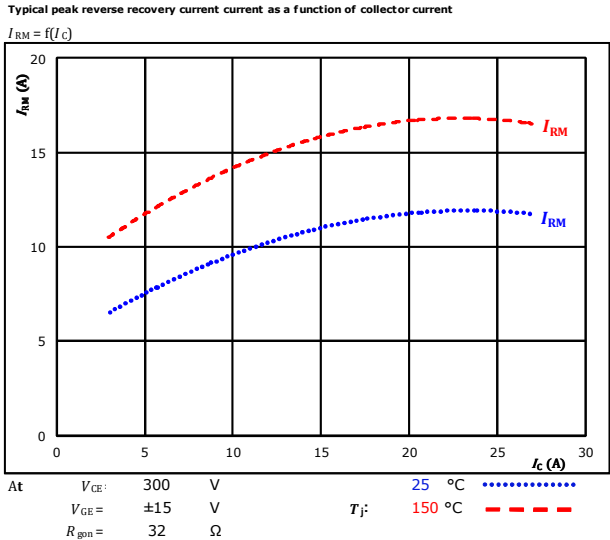
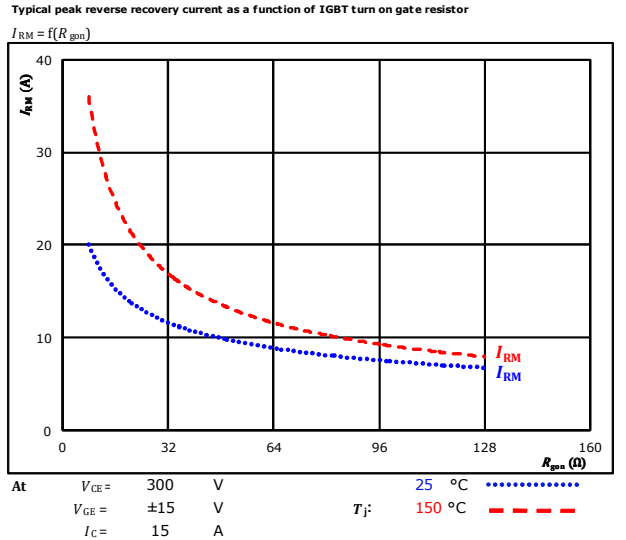

figure 12. FWD
Typical peak reverse recovery current as a function of IGBT turn on gate resistor





Vincotech

Inverter Switching Characteristics

figure 13. FWD

Typical rate of fall of forward and reverse recovery current as a function of collector current

$$di_F/dt, di_{rr}/dt = f(I_C)$$

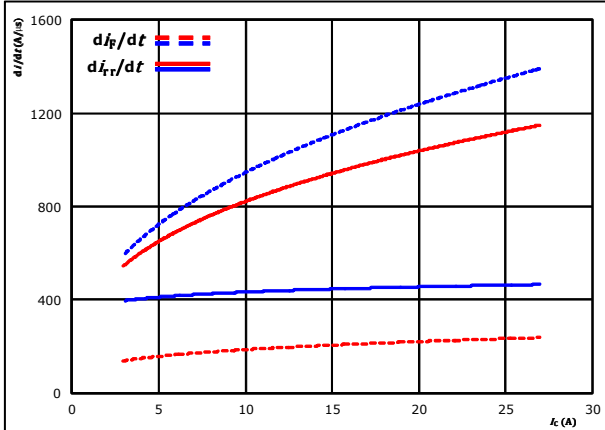

At $V_{CE} = 300$ V $T_J = 25$ °C
 $V_{CE} = \pm 15$ V $T_J = 150$ °C - - - - -
 $R_{gon} = 32$ Ω

figure 14. FWD

Typical rate of fall of forward and reverse recovery current as a function of IGBT turn on gate resistor

$$di_F/dt, di_{rr}/dt = f(R_g)$$

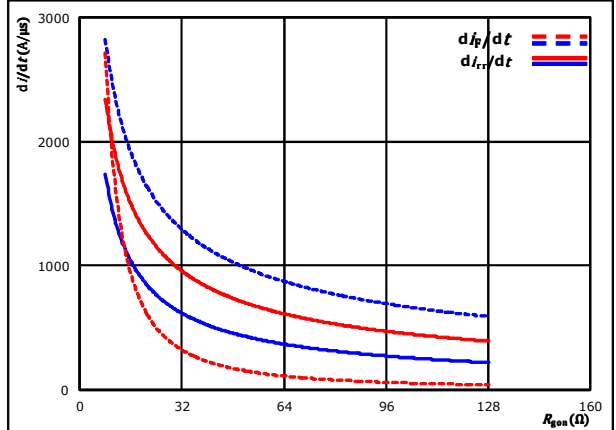

At $V_{CE} = 300$ V $T_J = 25$ °C
 $V_{CE} = \pm 15$ V $T_J = 150$ °C - - - - -
 $I_C = 15$ A

figure 15. IGBT

Reverse bias safe operating area

$$I_C = f(V_{CE})$$

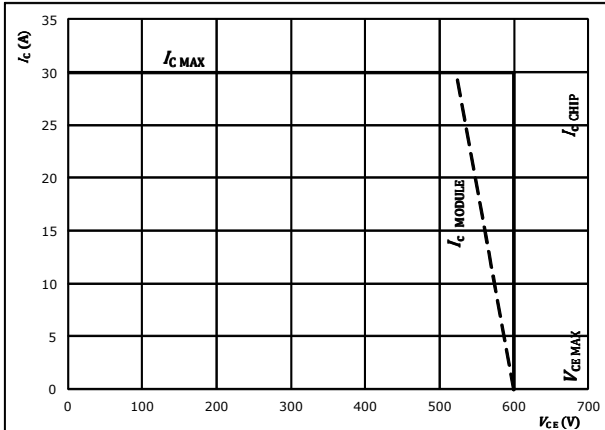

At $T_J = 175$ °C
 $R_{gon} = 32$ Ω
 $R_{goff} = 32$ Ω



Inverter Switching Definitions

General conditions		
T_j	=	150 °C
R_{gon}	=	32 Ω
R_{goff}	=	32 Ω

figure 1. IGBT
Turn-off Switching Waveforms & definition of t_{doff} , t_{Eoff} (t_{Eoff} = integrating time for E_{off})

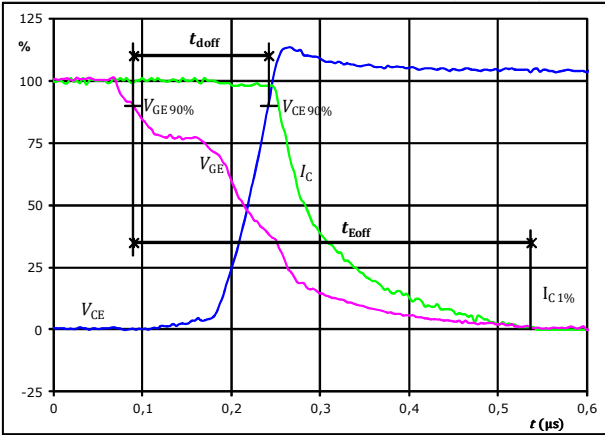

$V_{GE}(0\%)$	=	-15	V
$V_{GE}(100\%)$	=	15	V
$V_C(100\%)$	=	300	V
$I_C(100\%)$	=	15	A
t_{doff}	=	0,155	μs
t_{Eoff}	=	0,447	μs

figure 2. IGBT
Turn-on Switching Waveforms & definition of t_{don} , t_{Eon} (t_{Eon} = integrating time for E_{on})

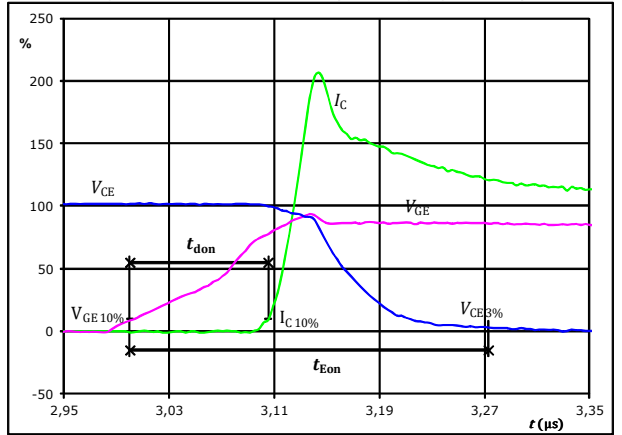

$V_{GE}(0\%)$	=	-15	V
$V_{GE}(100\%)$	=	15	V
$V_C(100\%)$	=	300	V
$I_C(100\%)$	=	15	A
t_{don}	=	0,105	μs
t_{Eon}	=	0,273	μs

figure 3. IGBT
Turn-off Switching Waveforms & definition of t_f

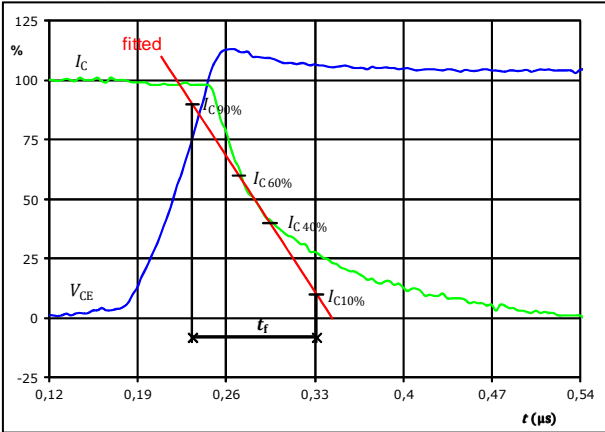

$V_C(100\%)$	=	300	V
$I_C(100\%)$	=	15	A
t_f	=	0,109	μs

figure 4. IGBT
Turn-on Switching Waveforms & definition of t_r

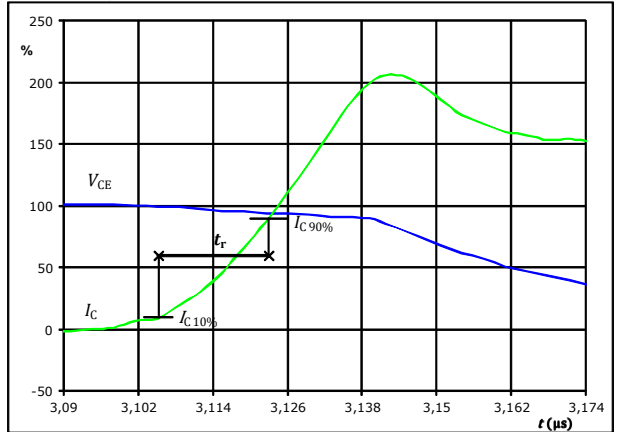

$V_C(100\%)$	=	300	V
$I_C(100\%)$	=	15	A
t_r	=	0,018	μs



Vincotech

Inverter Switching Definitions

figure 5. IGBT

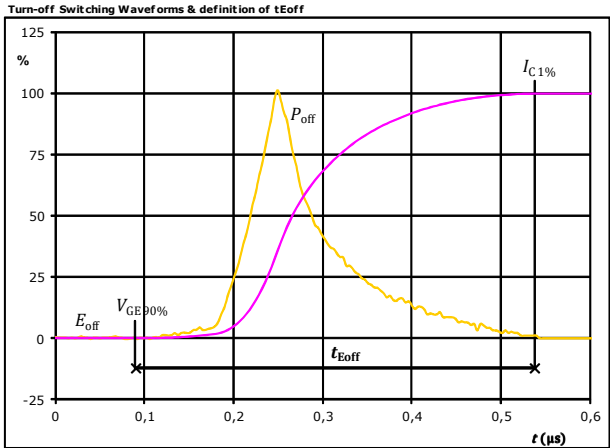

$P_{off}(100\%) = 4,50$ kW
 $E_{off}(100\%) = 0,46$ mJ
 $t_{Eoff} = 0,45$ μ s

figure 6. IGBT

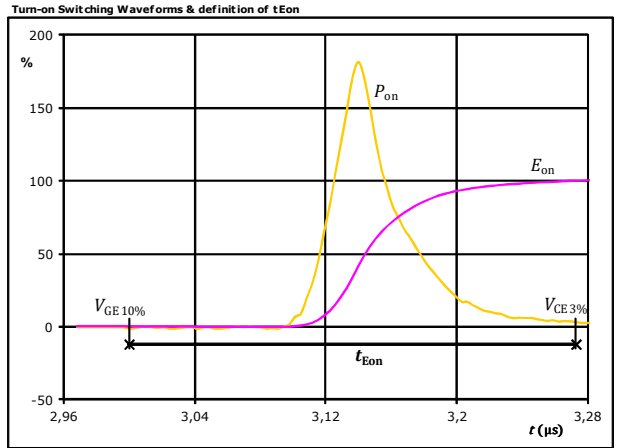

$P_{on}(100\%) = 4,50$ kW
 $E_{on}(100\%) = 0,38$ mJ
 $t_{Eon} = 0,27$ μ s

figure 7. FWD

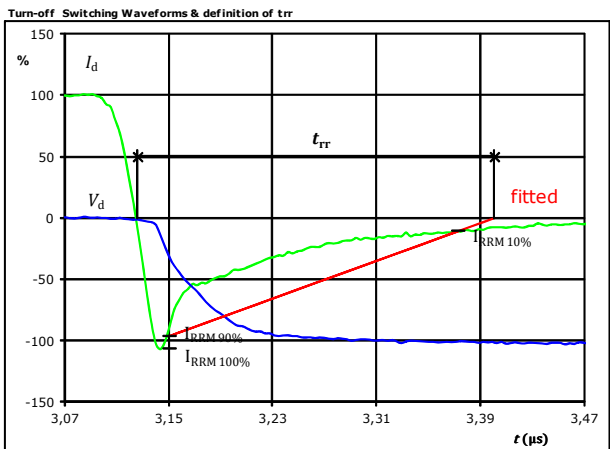

$V_d(100\%) = 300$ V
 $I_d(100\%) = 15$ A
 $I_{RRM}(100\%) = -16$ A
 $t_{tr} = 0,272$ μ s



Inverter Switching Definitions

figure 8. FWD
Turn-on Switching Waveforms & definition of t_{Qrr} (t_{Qrr} = integrating time for Q_{rr})

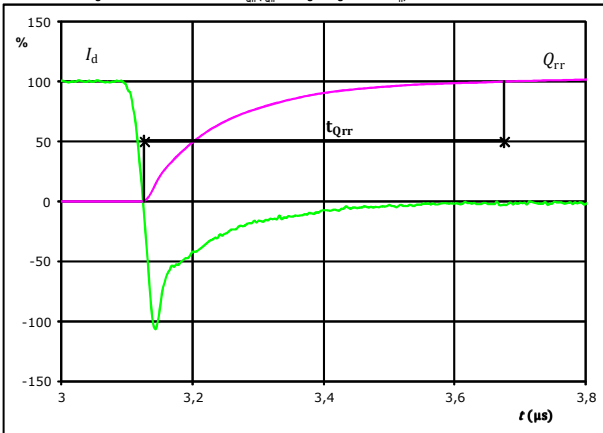

I_d (100%) =	15	A
Q_{rr} (100%) =	1,45	μC
t_{Qrr} =	0,55	μs

figure 9. FWD
Turn-on Switching Waveforms & definition of t_{Erec} (t_{Erec} = integrating time for E_{rec})

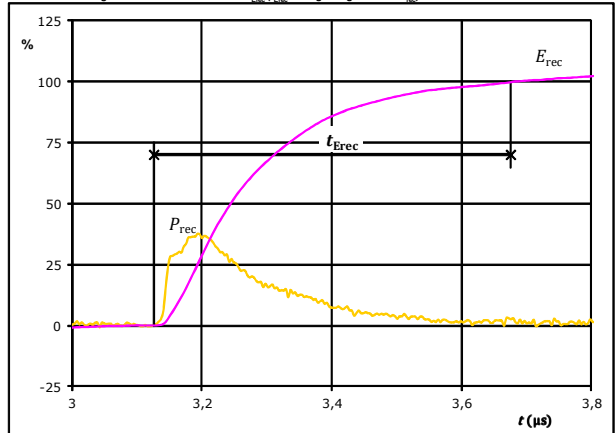

P_{rec} (100%) =	4,50	kW
E_{rec} (100%) =	0,31	mJ
t_{Erec} =	0,55	μs



Vincotech

Ordering Code & Marking						
Version			Ordering Code			
without thermal paste with Solder pins 17mm housing			10-0B066PA015SB-M994F09			
NN-NNNNNNNNNN NNNN-TTTTTTVV Vinco LLLLL WWYY SSSS UL						
Text	Name		Type&Ver	Date code	Vinco&Lot	Serial&UL
	NN-NNNNNNNNNNNNNN		TTTTTTTVV	WWYY	Vinco LLLLL	SSSS UL
Datamatrix	Type&Ver	Lot number	Serial	Date code		
	TTTTTTTVV	LLLLL	SSSS	WWYY		

Pin table [mm]			
Pin	X	Y	Function
1	27,8	0	G6
2	24,9	0	E6
3	19,1	0	G5
4	16,2	0	E5
5	11,6	0	NTC2
6	7,6	0	NTC1
7	2,9	0	E4
8	0	0	G4
9	0	13,7	U
10	2,9	13,7	G1
11	8,8	13,7	DC+
12	14,6	13,7	V
13	17,5	13,7	G2
14	24,9	13,7	G3
15	27,8	13,7	W

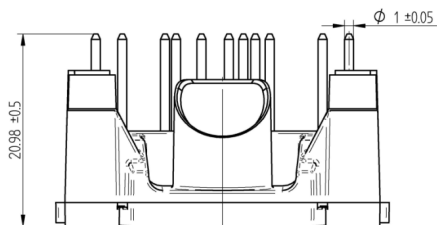
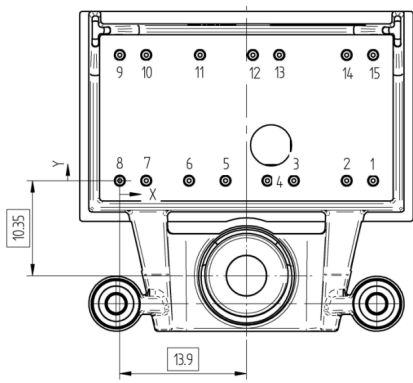



Tolerance of pinpositions: ±0,5mm at the end of pins
Dimension of coordinate axis is only offset without tolerance
PCB cutouts and holes see in handling instruction document

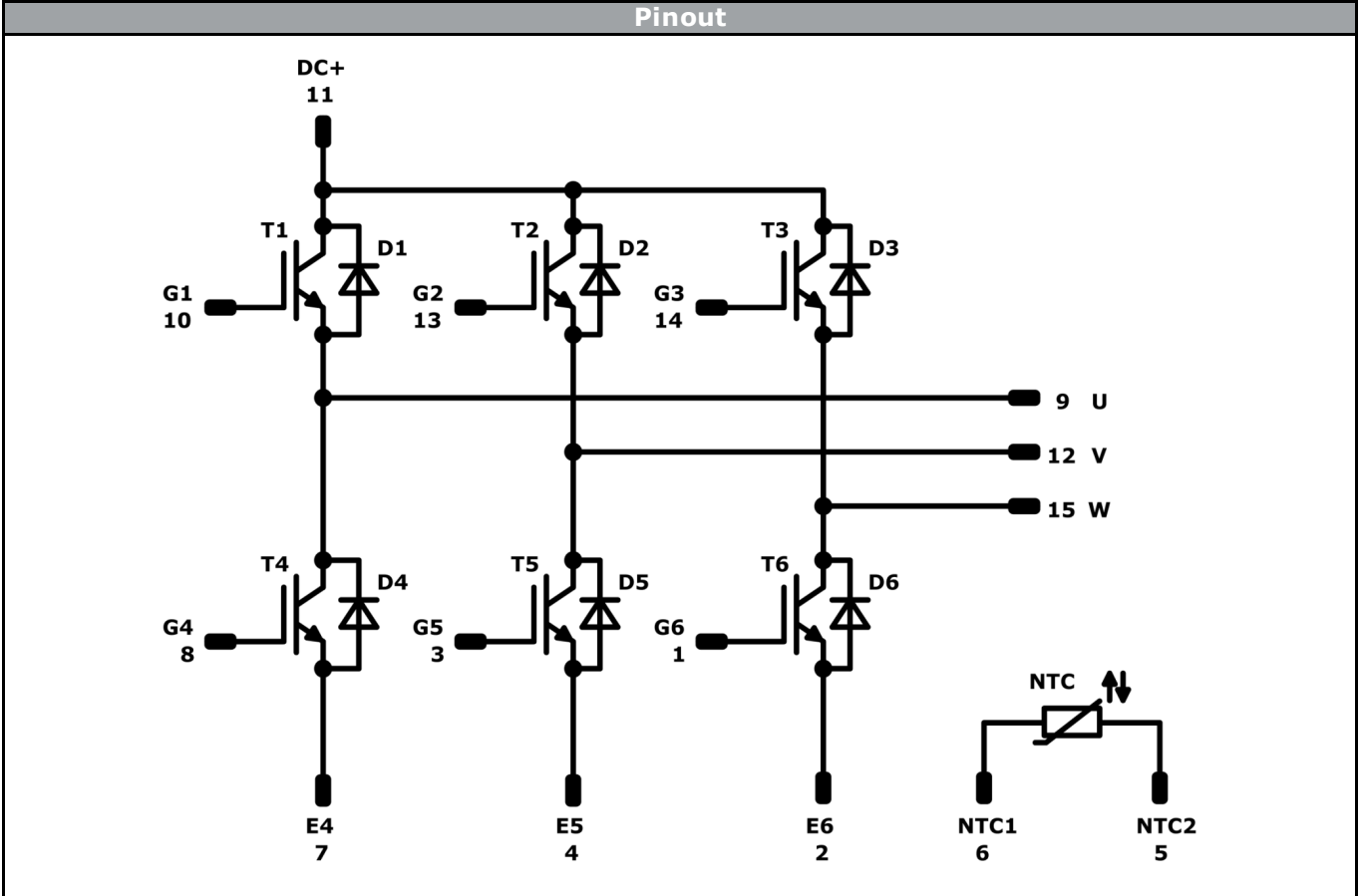

Vincotech

Pinout



Identification

ID	Component	Voltage	Current	Function	Comment
T1-T6	IGBT	600 V	15 A	Inverter Switch	
D1-D6	FWD	600 V	15 A	Inverter Diode	
NTC	NTC			Thermistor	



Vincotech

Packaging instruction					
Standard packaging quantity (SPQ)	160	>SPQ	Standard	<SPQ	Sample

Handling instruction
Handling instructions for <i>flow</i> 0 B packages see vincotech.com website.

Package data
Package data for <i>flow</i> 0 B packages see vincotech.com website.

Document No.:	Date:	Modification:	Pages
10-0B066PA015SB-M994F09-D3-14	23 Jun. 2017		

DISCLAIMER

The information, specifications, procedures, methods and recommendations herein (together "information") are presented by Vincotech to reader in good faith, are believed to be accurate and reliable, but may well be incomplete and/or not applicable to all conditions or situations that may exist or occur. Vincotech reserves the right to make any changes without further notice to any products to improve reliability, function or design. No representation, guarantee or warranty is made to reader as to the accuracy, reliability or completeness of said information or that the application or use of any of the same will avoid hazards, accidents, losses, damages or injury of any kind to persons or property or that the same will not infringe third parties rights or give desired results. It is reader's sole responsibility to test and determine the suitability of the information and the product for reader's intended use.

LIFE SUPPORT POLICY

Vincotech products are not authorised for use as critical components in life support devices or systems without the express written approval of Vincotech.

As used herein:

1. Life support devices or systems are devices or systems which, (a) are intended for surgical implant into the body, or (b) support or sustain life, or (c) whose failure to perform when properly used in accordance with instructions for use provided in labelling can be reasonably expected to result in significant injury to the user.
2. A critical component is any component of a life support device or system whose failure to perform can be reasonably expected to cause the failure of the life support device or system, or to affect its safety or effectiveness.