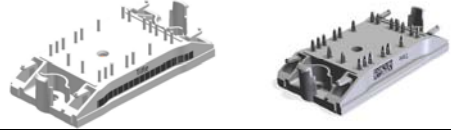
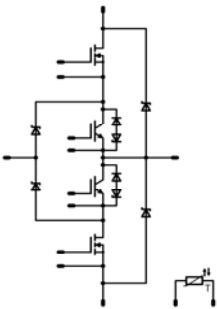


flowNPC 0	600V/30A
<div style="border: 1px solid black; padding: 5px; margin-bottom: 5px;"> <p style="text-align: center; background-color: #000080; color: white; margin: 0;">Features</p> <ul style="list-style-type: none"> neutral point clamped inverter reactive power capability low inductance layout </div> <div style="border: 1px solid black; padding: 5px; margin-bottom: 5px;"> <p style="text-align: center; background-color: #000080; color: white; margin: 0;">Target Applications</p> <ul style="list-style-type: none"> solar inverter UPS </div> <div style="border: 1px solid black; padding: 5px;"> <p style="text-align: center; background-color: #000080; color: white; margin: 0;">Types</p> <ul style="list-style-type: none"> 10-FZ06NRA041FS03-P965F78 10-PZ06NRA041FS03-P965F78Y </div>	<div style="border: 1px solid black; padding: 5px; margin-bottom: 5px;"> <p style="text-align: center; background-color: #000080; color: white; margin: 0;">flow0 12mm housing</p>  </div> <div style="border: 1px solid black; padding: 5px;"> <p style="text-align: center; background-color: #000080; color: white; margin: 0;">Schematic</p>  </div>

Maximum Ratings

T_j=25°C, unless otherwise specified

Parameter	Symbol	Condition	Value	Unit
Boost Inv. Diode				
Repetitive peak reverse voltage	V_{RRM}		600	V
Forward current per diode	I_{FAV}	DC current $T_h=80^\circ\text{C}$ $T_c=80^\circ\text{C}$	17 17	A
Maximum repetitive forward current	I_{FRM}	T_{jmax}	20	A
I ² t-value	I^2t	$t_p=10\text{ms}$ $T_j=25^\circ\text{C}$	9,5	A ² s
Power dissipation per Diode	P_{tot}	$T_j=T_{jmax}$ $T_h=80^\circ\text{C}$ $T_c=80^\circ\text{C}$	44 61	W
Maximum Junction Temperature	T_{jmax}		175	°C

Maximum Ratings

$T_j=25^{\circ}\text{C}$, unless otherwise specified

Parameter	Symbol	Condition	Value	Unit
Buck Diode				
Peak Repetitive Reverse Voltage	V_{RRM}		600	V
DC forward current	I_F	$T_j=T_{jmax}$ $T_h=80^{\circ}\text{C}$ $T_c=80^{\circ}\text{C}$	25 35	A
Non repetitive peak surge current	I_{FSM}	t_p limited by T_{jmax} 60Hz Single Half-Sine Wave $T_c=25^{\circ}\text{C}$	300	A
Power dissipation per Diode	P_{tot}	$T_j=T_{jmax}$ $T_h=80^{\circ}\text{C}$ $T_c=80^{\circ}\text{C}$	40 61	W
Maximum Junction Temperature	T_{jmax}		150	$^{\circ}\text{C}$
Buck MOSFET				
Drain to source breakdown voltage	V_{DS}		600	V
DC drain current	I_D	$T_j=T_{jmax}$ $T_h=80^{\circ}\text{C}$ $T_c=80^{\circ}\text{C}$	29 36	A
Pulsed drain current	I_{Dpulse}	t_p limited by T_{jmax} $T_c=25^{\circ}\text{C}$	272	A
Power dissipation	P_{tot}	$T_j=T_{jmax}$ $T_h=80^{\circ}\text{C}$ $T_c=80^{\circ}\text{C}$	78 118	W
Gate-source peak voltage	V_{gs}		± 20	V
Maximum Junction Temperature	T_{jmax}		150	$^{\circ}\text{C}$
Boost IGBT				
Collector-emitter break down voltage	V_{CE}		600	V
DC collector current	I_C	$T_j=T_{jmax}$ $T_h=80^{\circ}\text{C}$ $T_c=80^{\circ}\text{C}$	58 77	A
Pulsed collector current	I_{Cpuls}	t_p limited by T_{jmax}	225	A
Turn off safe operating area		$T_j \leq 175^{\circ}\text{C}$ $V_{CE} \leq V_{CES}$	225	A
Power dissipation per IGBT	P_{tot}	$T_h=80^{\circ}\text{C}$ $T_c=80^{\circ}\text{C}$	93 141	W
Gate-emitter peak voltage	V_{GE}		± 20	V
Short circuit ratings	t_{SC} V_{CC}	$T_j \leq 150^{\circ}\text{C}$ $V_{GE} = 15\text{V}$	6 360	μs V
Maximum Junction Temperature	T_{jmax}		175	$^{\circ}\text{C}$

Maximum Ratings

$T_j=25^{\circ}\text{C}$, unless otherwise specified

Parameter	Symbol	Condition	Value	Unit
-----------	--------	-----------	-------	------

Boost Diode

Peak Repetitive Reverse Voltage	V_{RRM}		1200	V	
DC forward current	I_F	$T_j=T_{jmax}$	$T_h=80^{\circ}\text{C}$	17	A
			$T_c=80^{\circ}\text{C}$	23	
Repetitive peak surge current	I_{FRM}	20kHz Square Wave	36	A	
Power dissipation per Diode	P_{tot}	$T_j=T_{jmax}$	$T_h=80^{\circ}\text{C}$	33	W
			$T_c=80^{\circ}\text{C}$	50	
Maximum Junction Temperature	T_{jmax}		150	$^{\circ}\text{C}$	

Thermal Properties

Storage temperature	T_{stg}		-40...+125	$^{\circ}\text{C}$
Operation temperature under switching condition	T_{op}		-40...+($T_{jmax} - 25$)	$^{\circ}\text{C}$

Insulation Properties

Insulation voltage	V_{is}	$t=2\text{s}$ DC voltage	4000	V
Creepage distance			min 12,7	mm
Clearance			min 12,7	mm

Characteristic Values

Parameter	Symbol	Conditions					Value			Unit				
		V_{GE} [V] or V_{GS} [V]	V_r [V] or V_{CE} [V] or V_{DS} [V]	I_c [A] or I_F [A] or I_b [A]	T_j	Min	Typ	Max						
Boost Inv. Diode														
Forward voltage	V_F				10	$T_j=25^\circ\text{C}$ $T_j=125^\circ\text{C}$	1,25	1,88 1,22	1,95	V				
Threshold voltage (for power loss calc. only)	V_{I0}				10	$T_j=25^\circ\text{C}$ $T_j=125^\circ\text{C}$		1,37 0,70		V				
Slope resistance (for power loss calc. only)	r_t				10	$T_j=25^\circ\text{C}$ $T_j=125^\circ\text{C}$		0,05 0,05		Ω				
Reverse current	I_r			600		$T_j=25^\circ\text{C}$ $T_j=125^\circ\text{C}$			0,027	mA				
Thermal resistance chip to heatsink per chip	R_{thJH}	Thermal grease thickness \leq 50um $\lambda = 1$ W/mK						2,17		K/W				
Buck Diode														
Diode forward voltage	V_F				30	$T_j=25^\circ\text{C}$ $T_j=125^\circ\text{C}$		2,28 1,76	2,8	V				
Reverse leakage current	I_r			600		$T_j=25^\circ\text{C}$ $T_j=125^\circ\text{C}$			100	μA				
Peak reverse recovery current	I_{RRM}	$R_{gon}=2 \Omega$	10	350	30	$T_j=25^\circ\text{C}$ $T_j=125^\circ\text{C}$		58 75		A				
Reverse recovery time	t_{rr}					$T_j=25^\circ\text{C}$ $T_j=125^\circ\text{C}$		14 24		ns				
Reverse recovered charge	Q_{rr}					$T_j=25^\circ\text{C}$ $T_j=125^\circ\text{C}$		0,38 0,95		μC				
Peak rate of fall of recovery current	$di(rec)/max/dt$					$T_j=25^\circ\text{C}$ $T_j=125^\circ\text{C}$		17148 12194		A/ μs				
Reverse recovered energy	E_{rec}					$T_j=25^\circ\text{C}$ $T_j=125^\circ\text{C}$		0,06 0,14		mWs				
Thermal resistance chip to heatsink per chip	R_{thJH}					Thermal grease thickness \leq 50um $\lambda = 1$ W/mK						1,74		K/W
Buck MOSFET														
Static drain to source ON resistance	$R_{ds(on)}$		10		30	$T_j=25^\circ\text{C}$ $T_j=125^\circ\text{C}$		41 82		m Ω				
Gate threshold voltage	$V_{(GS)th}$			$V_{DS}=V_{GS}$	0,00296	$T_j=25^\circ\text{C}$ $T_j=125^\circ\text{C}$	2,4	3	3,6	V				
Gate to Source Leakage Current	I_{gss}		20	0		$T_j=25^\circ\text{C}$ $T_j=125^\circ\text{C}$			100	nA				
Zero Gate Voltage Drain Current	I_{dss}		0	600		$T_j=25^\circ\text{C}$ $T_j=125^\circ\text{C}$			5000	μA				
Turn On Delay Time	$t_{d(ON)}$	$R_{goff}=2 \Omega$ $R_{gon}=2 \Omega$	10	350	30	$T_j=25^\circ\text{C}$ $T_j=125^\circ\text{C}$		23 22		ns				
Rise Time	t_r					$T_j=25^\circ\text{C}$ $T_j=125^\circ\text{C}$		5 6						
Turn off delay time	$t_{d(OFF)}$					$T_j=25^\circ\text{C}$ $T_j=125^\circ\text{C}$		123 134						
Fall time	t_f					$T_j=25^\circ\text{C}$ $T_j=125^\circ\text{C}$		5 7						
Turn-on energy loss per pulse	E_{on}					$T_j=25^\circ\text{C}$ $T_j=125^\circ\text{C}$		0,15 0,28		mWs				
Turn-off energy loss per pulse	E_{off}					$T_j=25^\circ\text{C}$ $T_j=125^\circ\text{C}$		0,05 0,07						
Total gate charge	Q_g											290		nC
Gate to source charge	Q_{gs}		10	480	44,4	$T_j=25^\circ\text{C}$		36						
Gate to drain charge	Q_{gd}							150						
Input capacitance	C_{iss}							6530		pF				
Output capacitance	C_{oss}	$f=1\text{MHz}$	0	100		$T_j=25^\circ\text{C}$		360						
Gate resistor	r_G							0,7		Ω				
Thermal resistance chip to heatsink per chip	R_{thJH}	Thermal grease thickness \leq 50um $\lambda = 1$ W/mK						0,90		K/W				

Characteristic Values

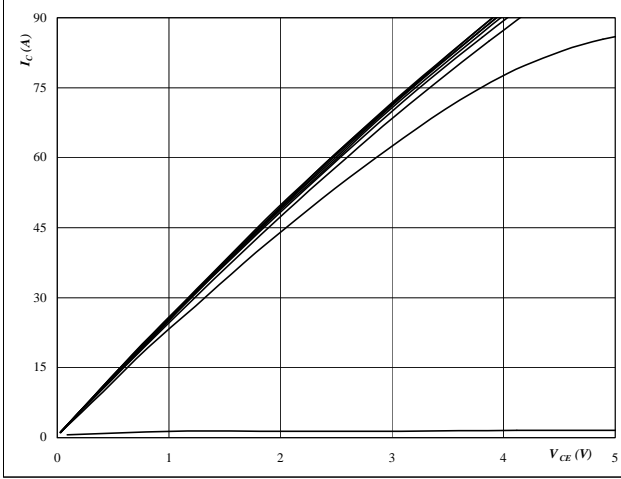
Parameter	Symbol	Conditions					Value			Unit
		V_{GE} [V] or V_{GS} [V]	V_r [V] or V_{CE} [V] or V_{DS} [V]	I_c [A] or I_F [A] or I_b [A]	T_j	Min	Typ	Max		
Boost IGBT										
Gate emitter threshold voltage	$V_{GE(th)}$	$V_{CE}=V_{GE}$			0,0012	$T_j=25^\circ\text{C}$ $T_j=125^\circ\text{C}$	5	5,8	6,5	V
Collector-emitter saturation voltage	$V_{CE(sat)}$		15		30	$T_j=25^\circ\text{C}$ $T_j=125^\circ\text{C}$	1,05	1,22 1,29	1,85	V
Collector-emitter cut-off incl diode	I_{CES}		0	600		$T_j=25^\circ\text{C}$ $T_j=125^\circ\text{C}$			0,0038	mA
Gate-emitter leakage current	I_{GES}		20	0		$T_j=25^\circ\text{C}$ $T_j=125^\circ\text{C}$			600	nA
Integrated Gate resistor	R_{gint}							none		Ω
Turn-on delay time	$t_{d(on)}$	$R_{goff}=4\ \Omega$ $R_{gon}=4\ \Omega$	± 15	350	30	$T_j=25^\circ\text{C}$		84		ns
Rise time	t_r					$T_j=125^\circ\text{C}$		84		
Turn-off delay time	$t_{d(off)}$					$T_j=25^\circ\text{C}$		7		
Fall time	t_f					$T_j=125^\circ\text{C}$		8		
Turn-on energy loss per pulse	E_{on}					$T_j=25^\circ\text{C}$		204		
Turn-off energy loss per pulse	E_{off}	$T_j=125^\circ\text{C}$		242						
Input capacitance	C_{ies}					$T_j=25^\circ\text{C}$		55		mWs
Output capacitance	C_{oss}	$f=1\text{MHz}$	0	25		$T_j=125^\circ\text{C}$		90		
Reverse transfer capacitance	C_{rss}							0,26 0,39		
Gate charge	Q_{Gate}		15	480	75	$T_j=25^\circ\text{C}$		0,99 1,36		
Thermal resistance chip to heatsink per chip	$R_{th,JH}$	Thermal grease thickness $\leq 50\mu\text{m}$ $\lambda = 1\ \text{W/mK}$						4620		pF
Boost Diode										
Diode forward voltage	V_F				18	$T_j=25^\circ\text{C}$ $T_j=125^\circ\text{C}$		2,23 2,04	3,5	V
Reverse leakage current	I_r			1200		$T_j=25^\circ\text{C}$ $T_j=125^\circ\text{C}$			100	μA
Peak reverse recovery current	I_{RRM}	$R_{gon}=4\ \Omega$	± 15	350	30	$T_j=25^\circ\text{C}$		59		A
Reverse recovery time	t_{rr}					$T_j=125^\circ\text{C}$		67		
Reverse recovered charge	Q_{rr}					$T_j=25^\circ\text{C}$		21		
Peak rate of fall of recovery current	$di(rec)_{max}/dt$					$T_j=125^\circ\text{C}$		102		
Reverse recovery energy	E_{rec}					$T_j=25^\circ\text{C}$		2,53 4,72		
Thermal resistance chip to heatsink per chip	$R_{th,JH}$	Thermal grease thickness $\leq 50\mu\text{m}$ $\lambda = 1\ \text{W/mK}$						9919 5374		A/ μs
						$T_j=25^\circ\text{C}$ $T_j=125^\circ\text{C}$		0,75 1,45		mWs
								2,11		K/W
Thermistor										
Rated resistance	R					$T_j=25^\circ\text{C}$		21511		Ω
Deviation of R25	$\Delta R/R$	$R_{100}=1486\ \Omega$				$T_j=25^\circ\text{C}$	-4,5		+4,5	%
Power dissipation	P					$T_j=25^\circ\text{C}$		210		mW
Power dissipation constant						$T_j=25^\circ\text{C}$		4		mW/K
B-value	$B_{(25/50)}$					$T_j=25^\circ\text{C}$		3884		K
B-value	$B_{(25/100)}$					$T_j=25^\circ\text{C}$		3964		K
Vincotech NTC Reference									F	

Buck

Figure 1 MOSFET

Typical output characteristics

$I_C = f(V_{CE})$

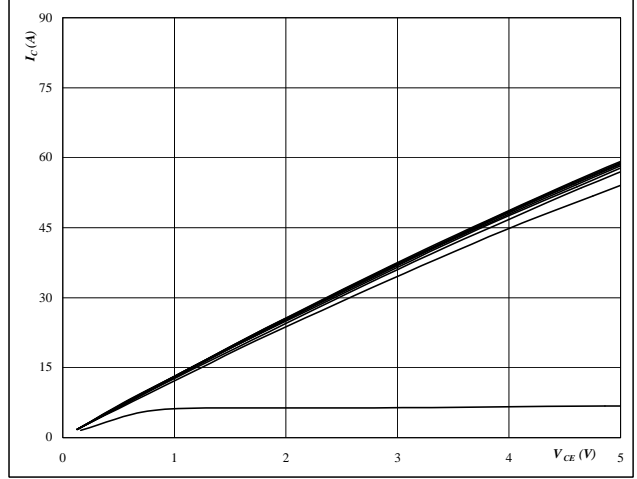


At
 $t_p = 250 \mu s$
 $T_j = 25 \text{ }^\circ C$
 V_{GE} from 0 V to 20 V in steps of 2 V

Figure 2 MOSFET

Typical output characteristics

$I_C = f(V_{CE})$

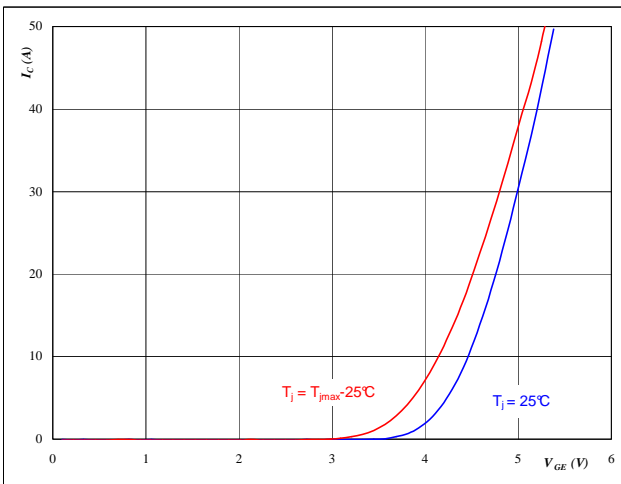


At
 $t_p = 250 \mu s$
 $T_j = 125 \text{ }^\circ C$
 V_{GE} from 0 V to 20 V in steps of 2 V

Figure 3 MOSFET

Typical transfer characteristics

$I_C = f(V_{GE})$

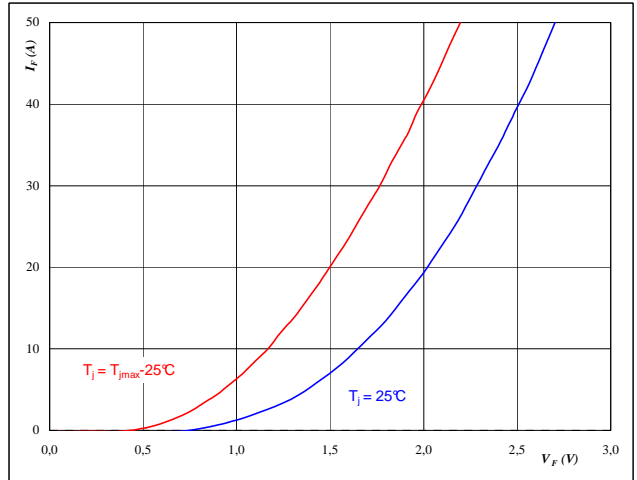


At
 $t_p = 250 \mu s$
 $V_{CE} = 10 V$

Figure 4 FWD

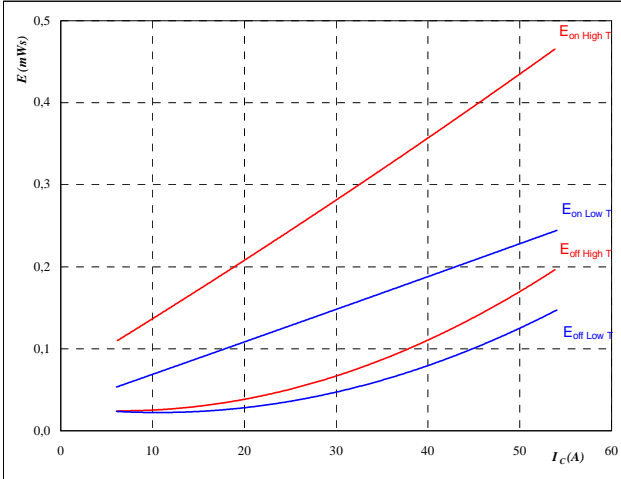
Typical diode forward current as a function of forward voltage

$I_F = f(V_F)$



At
 $t_p = 250 \mu s$

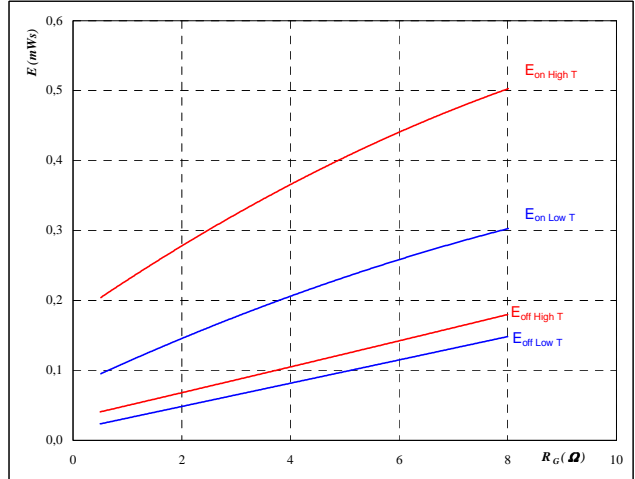
Buck
Figure 5 MOSFET

Typical switching energy losses
as a function of collector current
 $E = f(I_C)$


With an inductive load at

$T_j =$	25/125	°C
$V_{CE} =$	350	V
$V_{GE} =$	10	V
$R_{gon} =$	2	Ω
$R_{goff} =$	2	Ω

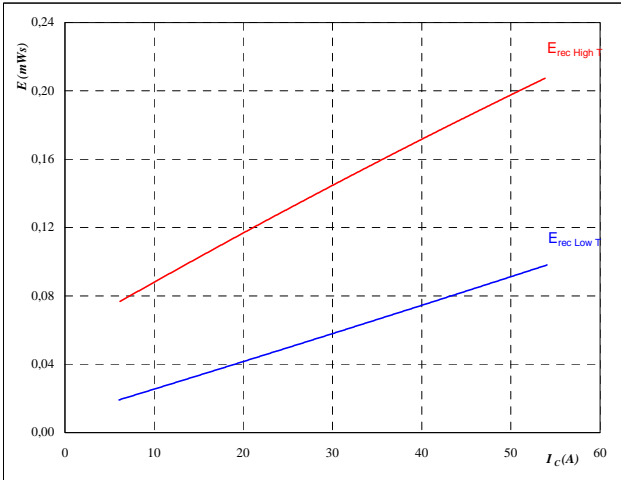
Figure 6 MOSFET

Typical switching energy losses
as a function of gate resistor
 $E = f(R_G)$


With an inductive load at

$T_j =$	25/125	°C
$V_{CE} =$	350	V
$V_{GE} =$	10	V
$I_C =$	30	A

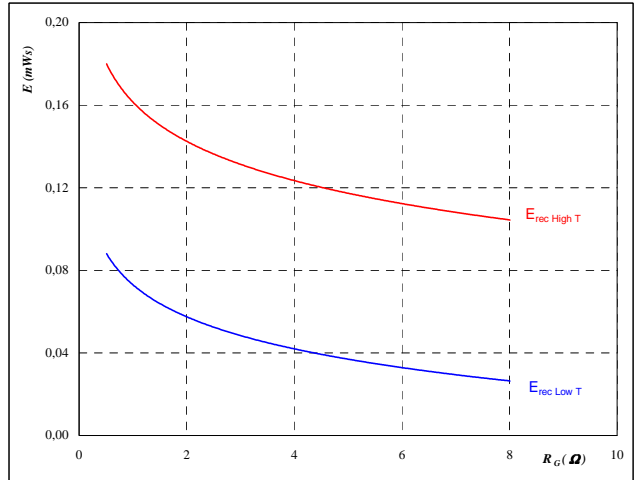
Figure 7 FWD

Typical reverse recovery energy loss
as a function of collector current
 $E_{rec} = f(I_C)$


With an inductive load at

$T_j =$	25/125	°C
$V_{CE} =$	350	V
$V_{GE} =$	10	V
$R_{gon} =$	2	Ω

Figure 8 FWD

Typical reverse recovery energy loss
as a function of gate resistor
 $E_{rec} = f(R_G)$


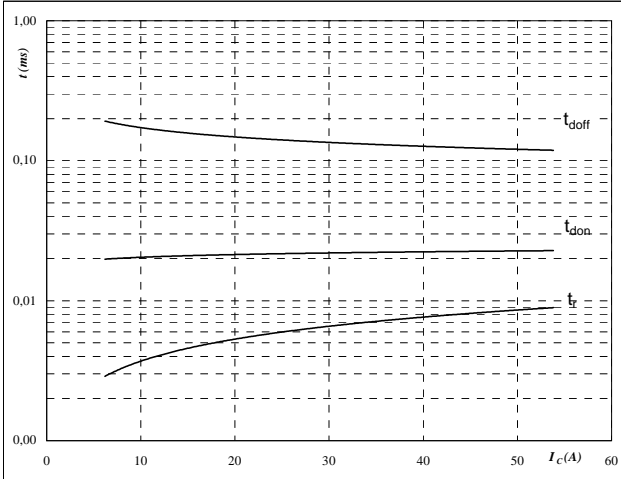
With an inductive load at

$T_j =$	25/125	°C
$V_{CE} =$	350	V
$V_{GE} =$	10	V
$I_C =$	30	A

Buck

Figure 9 MOSFET

Typical switching times as a function of collector current
 $t = f(I_C)$

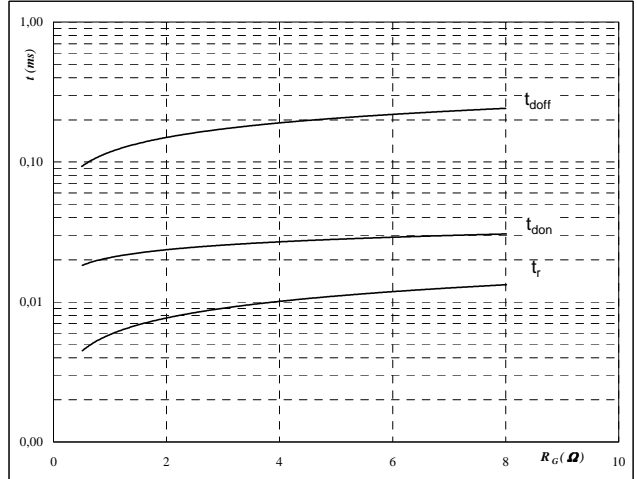


With an inductive load at

$T_j = 125 \text{ } ^\circ\text{C}$
 $V_{CE} = 350 \text{ V}$
 $V_{GE} = 10 \text{ V}$
 $R_{gon} = 2 \text{ } \Omega$
 $R_{goff} = 2 \text{ } \Omega$

Figure 10 MOSFET

Typical switching times as a function of gate resistor
 $t = f(R_G)$

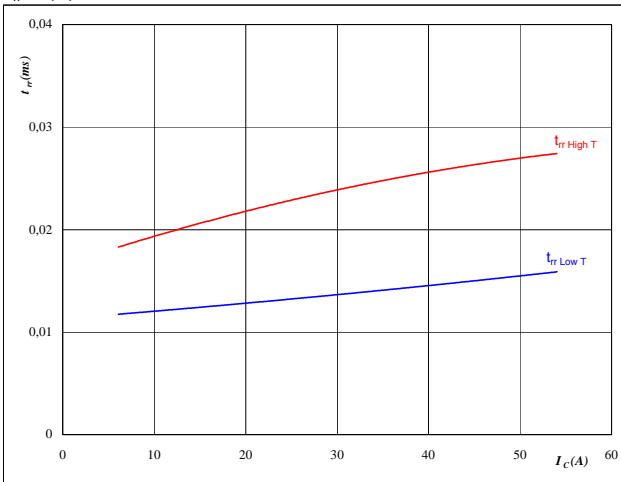


With an inductive load at

$T_j = 125 \text{ } ^\circ\text{C}$
 $V_{CE} = 350 \text{ V}$
 $V_{GE} = 10 \text{ V}$
 $I_C = 30 \text{ A}$

Figure 11 FWD

Typical reverse recovery time as a function of collector current
 $t_{rr} = f(I_C)$

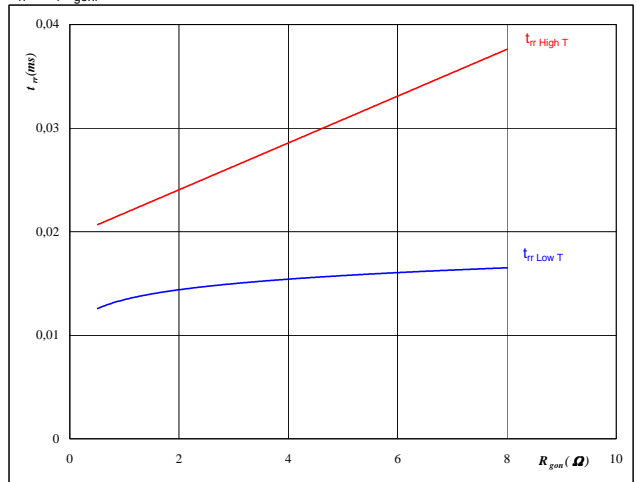


At

$T_j = 25/125 \text{ } ^\circ\text{C}$
 $V_{CE} = 350 \text{ V}$
 $V_{GE} = 10 \text{ V}$
 $R_{gon} = 2 \text{ } \Omega$

Figure 12 FWD

Typical reverse recovery time as a function of MOSFET turn on gate resistor
 $t_{rr} = f(R_{gon})$



At

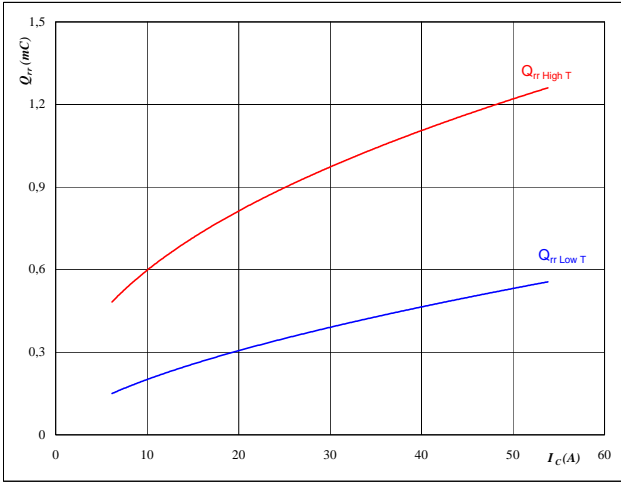
$T_j = 25/125 \text{ } ^\circ\text{C}$
 $V_R = 350 \text{ V}$
 $I_F = 30 \text{ A}$
 $V_{GE} = 10 \text{ V}$

Buck

Figure 13 FWD

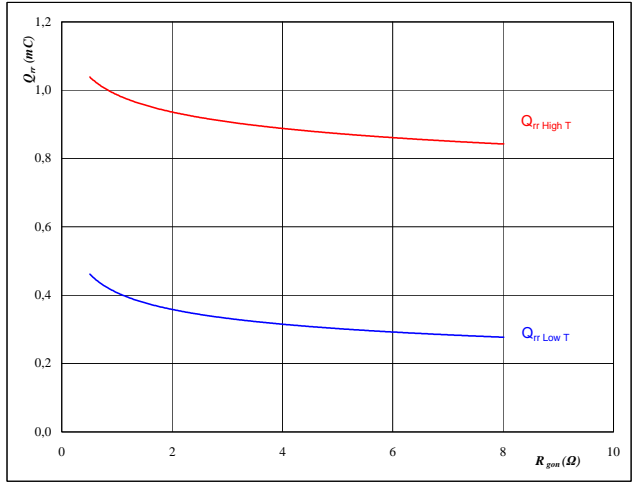
Typical reverse recovery charge as a function of collector current

$$Q_{rr} = f(I_C)$$


At
 $T_j = 25/125 \text{ } ^\circ\text{C}$
 $V_{CE} = 350 \text{ V}$
 $V_{GE} = 10 \text{ V}$
 $R_{gon} = 2 \text{ } \Omega$
Figure 14 FWD

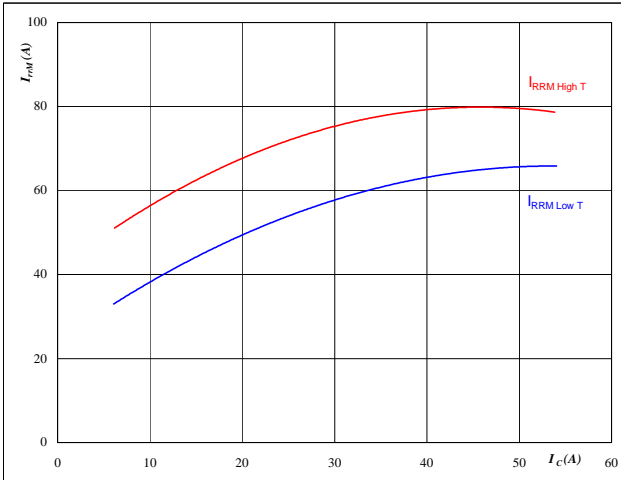
Typical reverse recovery charge as a function of MOSFET turn on gate resistor

$$Q_{rr} = f(R_{gon})$$


At
 $T_j = 25/125 \text{ } ^\circ\text{C}$
 $V_R = 350 \text{ V}$
 $I_F = 30 \text{ A}$
 $V_{GE} = 10 \text{ V}$
Figure 15 FWD

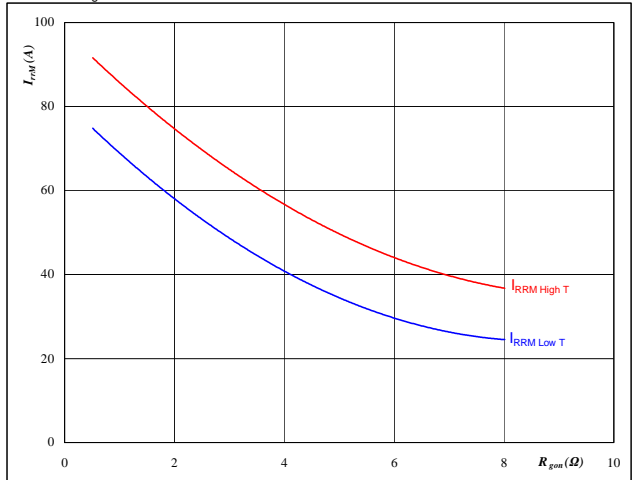
Typical reverse recovery current as a function of collector current

$$I_{RRM} = f(I_C)$$

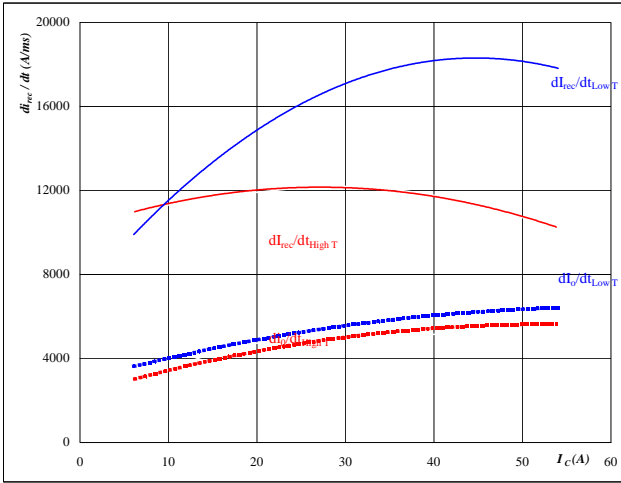

At
 $T_j = 25/125 \text{ } ^\circ\text{C}$
 $V_{CE} = 350 \text{ V}$
 $V_{GE} = 10 \text{ V}$
 $R_{gon} = 2 \text{ } \Omega$
Figure 16 FWD

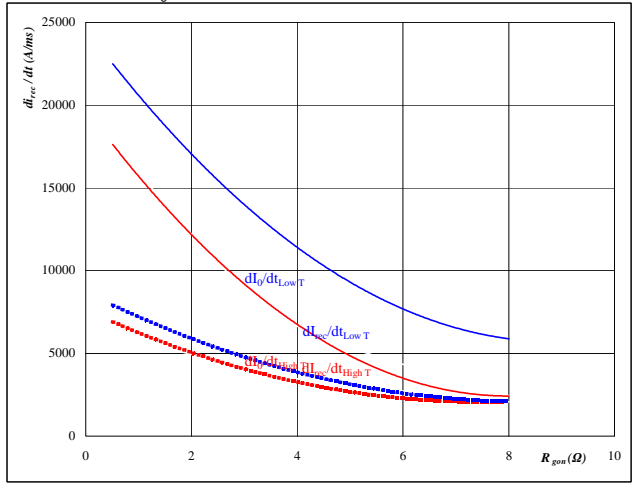
Typical reverse recovery current as a function of MOSFET turn on gate resistor

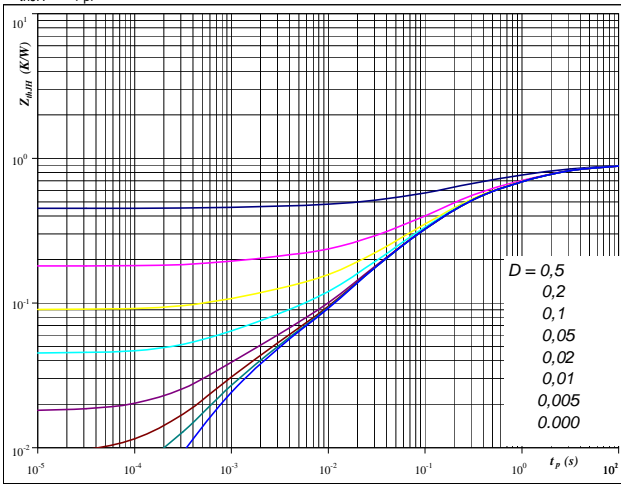
$$I_{RRM} = f(R_{gon})$$


At
 $T_j = 25/125 \text{ } ^\circ\text{C}$
 $V_R = 350 \text{ V}$
 $I_F = 30 \text{ A}$
 $V_{GE} = 10 \text{ V}$

Buck
Figure 17 FWD

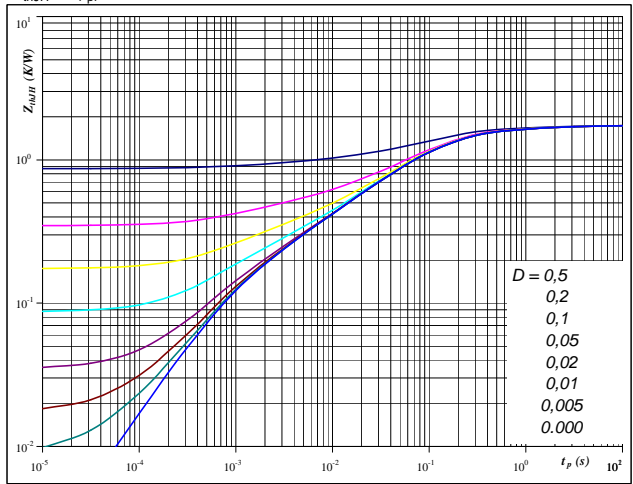
Typical rate of fall of forward and reverse recovery current as a function of collector current
 $di_f/dt, di_{rec}/dt = f(I_c)$

At
 $T_j = 25/125 \text{ } ^\circ\text{C}$
 $V_{CE} = 350 \text{ V}$
 $V_{GE} = 10 \text{ V}$
 $R_{gon} = 2 \text{ } \Omega$
Figure 18 FWD

Typical rate of fall of forward and reverse recovery current as a function of MOSFET turn on gate resistor
 $di_f/dt, di_{rec}/dt = f(R_{gon})$

At
 $T_j = 25/125 \text{ } ^\circ\text{C}$
 $V_R = 350 \text{ V}$
 $I_F = 30 \text{ A}$
 $V_{GE} = 10 \text{ V}$
Figure 19 MOSFET

MOSFET transient thermal impedance as a function of pulse width
 $Z_{thJH} = f(t_p)$

At
 $D = t_p / T$
 $R_{thJH} = 0,90 \text{ K/W}$
IGBT thermal model values

R (C/W)	Tau (s)
0,13	4,5E+00
0,26	1,1E+00
0,25	2,4E-01
0,18	8,4E-02
0,07	1,5E-02
0,03	1,1E-03

Figure 20 FWD

FWD transient thermal impedance as a function of pulse width
 $Z_{thJH} = f(t_p)$

At
 $D = t_p / T$
 $R_{thJH} = 1,74 \text{ K/W}$
FWD thermal model values

R (C/W)	Tau (s)
0,09	3,4E+00
0,23	5,1E-01
0,85	1,0E-01
0,33	2,5E-02
0,13	4,5E-03
0,11	8,6E-04

Buck

Figure 21 MOSFET

Power dissipation as a function of heatsink temperature

$$P_{tot} = f(T_h)$$

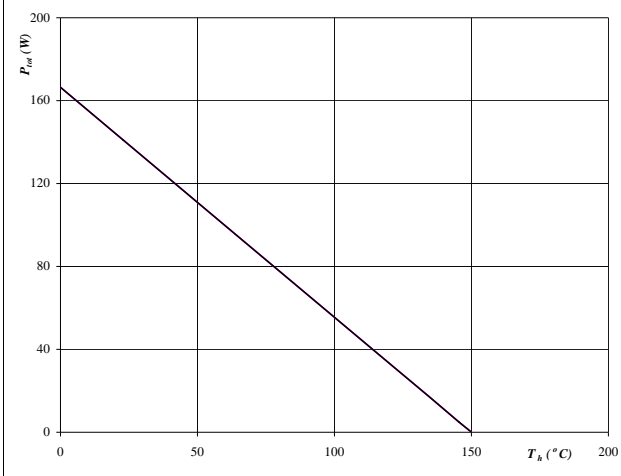

At
 $T_j = 150$ °C

Figure 22 MOSFET

Collector current as a function of heatsink temperature

$$I_C = f(T_h)$$

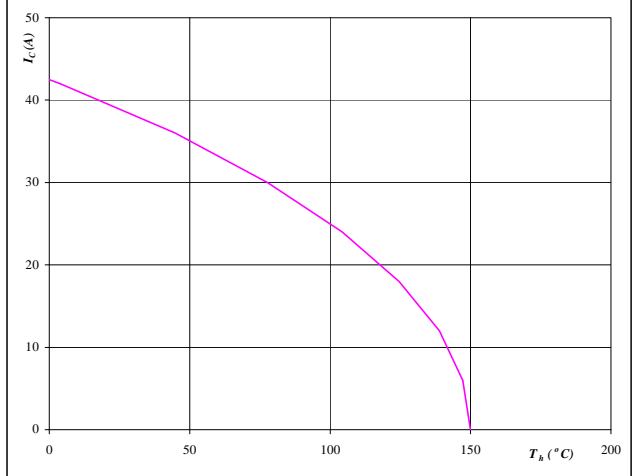

At
 $T_j = 150$ °C
 $V_{GE} = 15$ V

Figure 23 FWD

Power dissipation as a function of heatsink temperature

$$P_{tot} = f(T_h)$$

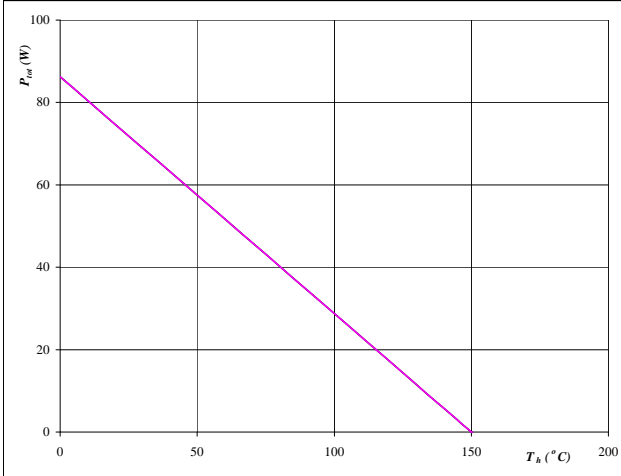
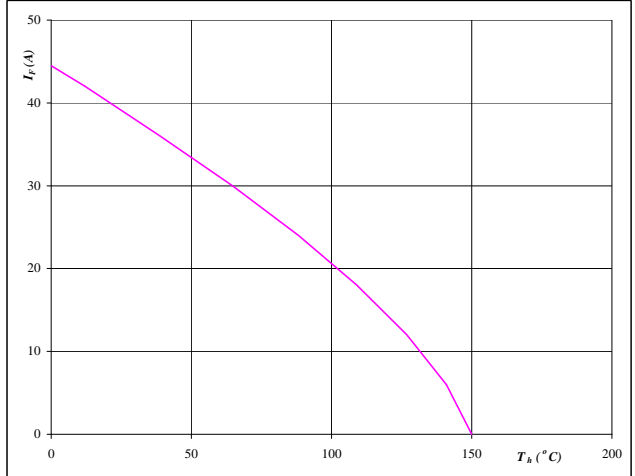

At
 $T_j = 150$ °C

Figure 24 FWD

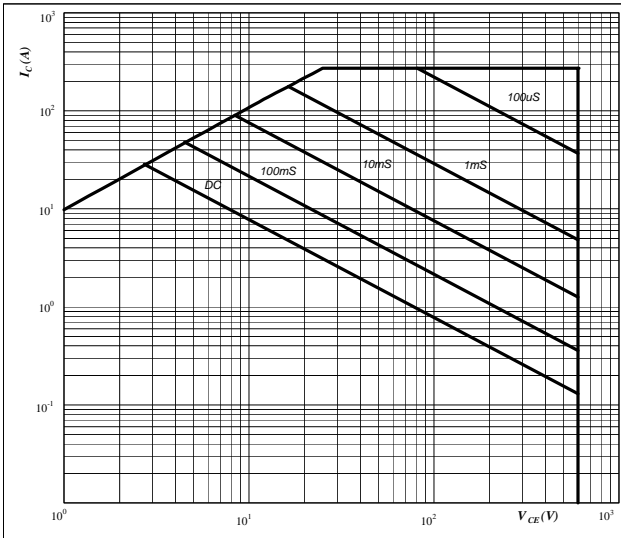
Forward current as a function of heatsink temperature

$$I_F = f(T_h)$$


At
 $T_j = 150$ °C

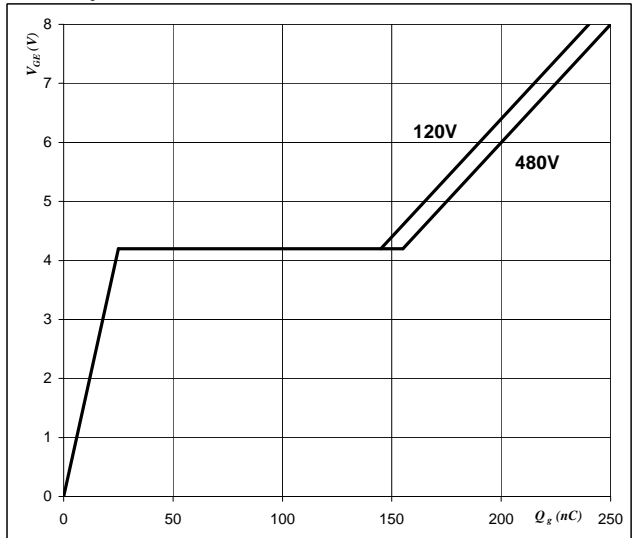
Buck

Figure 25 MOSFET

Safe operating area as a function of collector-emitter voltage
 $I_C = f(V_{CE})$


At
 D = single pulse
 Th = 80 °C
 V_{GE} = 15 V
 T_J = T_{jmax} °C

Figure 26 MOSFET

Gate voltage vs Gate charge
 $V_{GE} = f(Q_g)$


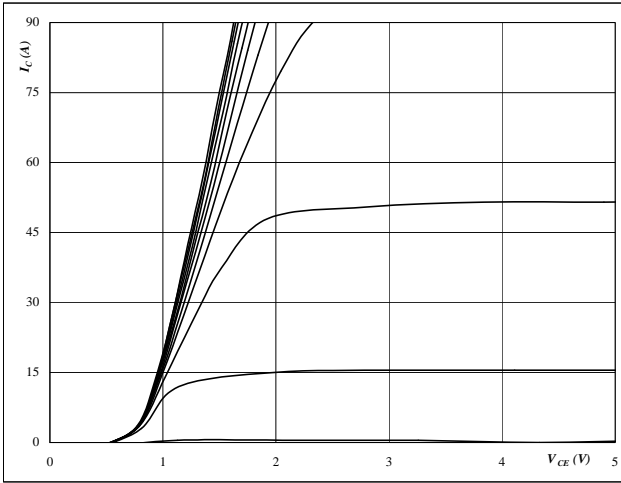
At
 I_D = 44,4 A

Boost

Figure 1 IGBT

Typical output characteristics

$I_C = f(V_{CE})$

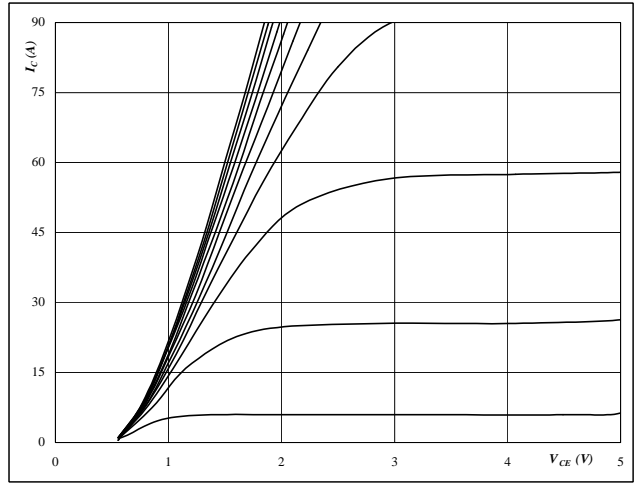


At
 $t_p = 250 \mu s$
 $T_j = 25 \text{ }^\circ C$
 V_{GE} from 7 V to 17 V in steps of 1 V

Figure 2 IGBT

Typical output characteristics

$I_C = f(V_{CE})$

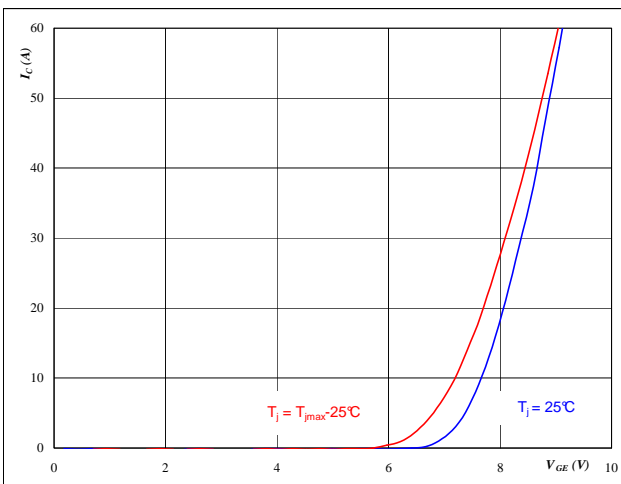


At
 $t_p = 250 \mu s$
 $T_j = 125 \text{ }^\circ C$
 V_{GE} from 7 V to 17 V in steps of 1 V

Figure 3 IGBT

Typical transfer characteristics

$I_C = f(V_{GE})$

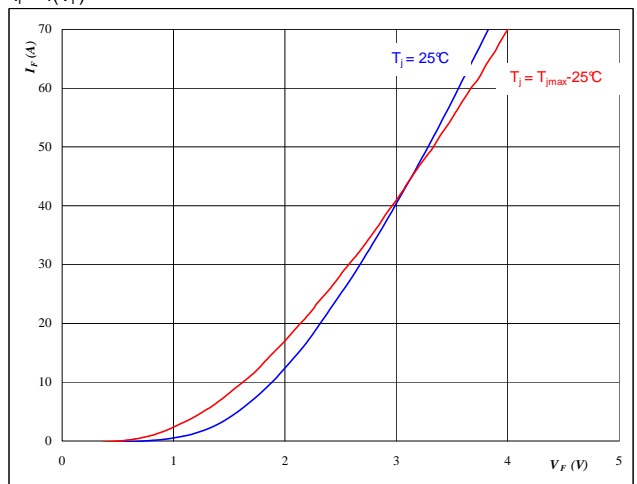


At
 $t_p = 250 \mu s$
 $V_{CE} = 10 V$

Figure 4 FWD

Typical diode forward current as a function of forward voltage

$I_F = f(V_F)$

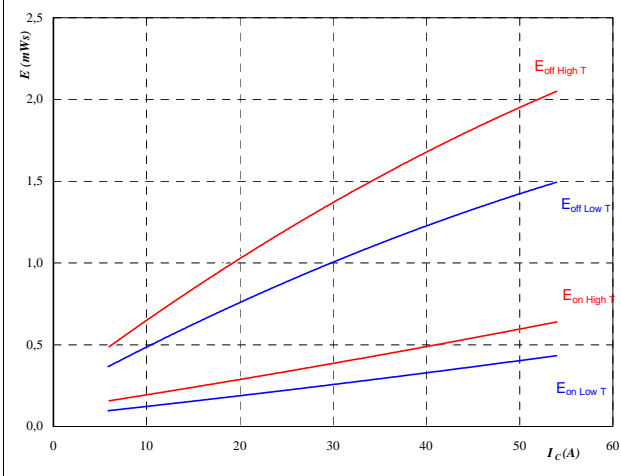


At
 $t_p = 250 \mu s$

Boost

Figure 5 IGBT

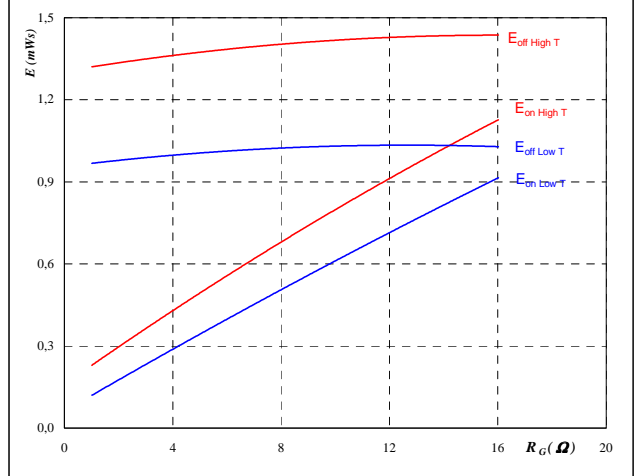
Typical switching energy losses
as a function of collector current
 $E = f(I_C)$



With an inductive load at
 $T_j = 25/125 \text{ } ^\circ\text{C}$
 $V_{CE} = 350 \text{ V}$
 $V_{GE} = \pm 15 \text{ V}$
 $R_{gon} = 4 \text{ } \Omega$
 $R_{goff} = 4 \text{ } \Omega$

Figure 6 IGBT

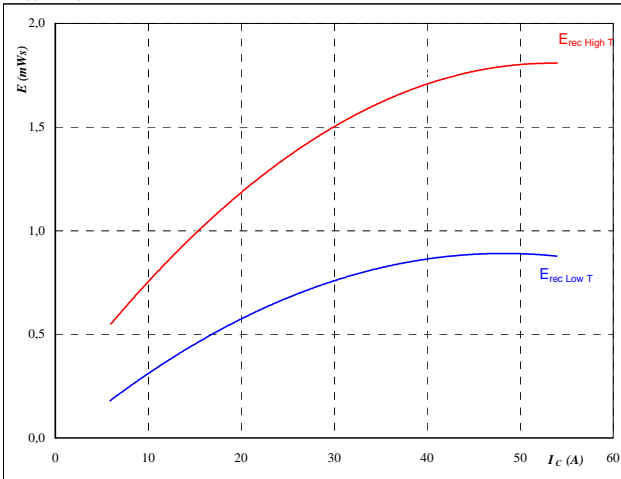
Typical switching energy losses
as a function of gate resistor
 $E = f(R_G)$



With an inductive load at
 $T_j = 25/125 \text{ } ^\circ\text{C}$
 $V_{CE} = 350 \text{ V}$
 $V_{GE} = \pm 15 \text{ V}$
 $I_C = 30 \text{ A}$

Figure 7 IGBT

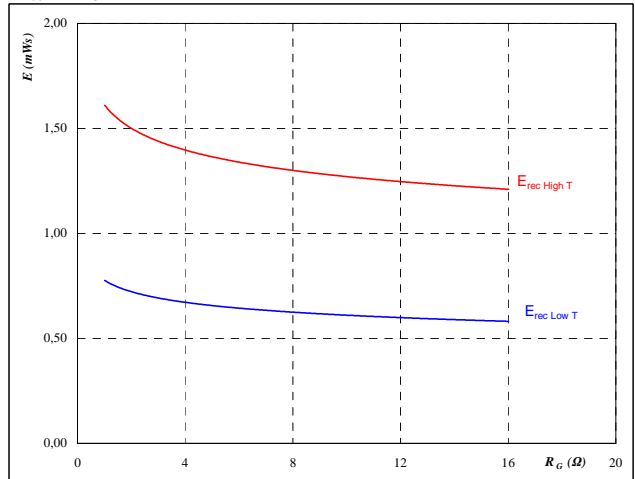
Typical reverse recovery energy loss
as a function of collector current
 $E_{rec} = f(I_C)$



With an inductive load at
 $T_j = 25/125 \text{ } ^\circ\text{C}$
 $V_{CE} = 350 \text{ V}$
 $V_{GE} = \pm 15 \text{ V}$
 $R_{gon} = 4 \text{ } \Omega$

Figure 8 IGBT

Typical reverse recovery energy loss
as a function of gate resistor
 $E_{rec} = f(R_G)$

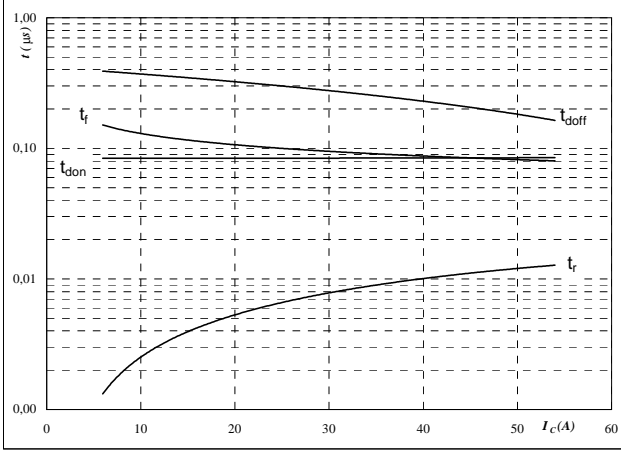


With an inductive load at
 $T_j = 25/125 \text{ } ^\circ\text{C}$
 $V_{CE} = 350 \text{ V}$
 $V_{GE} = \pm 15 \text{ V}$
 $I_C = 30 \text{ A}$

Boost

Figure 9 IGBT

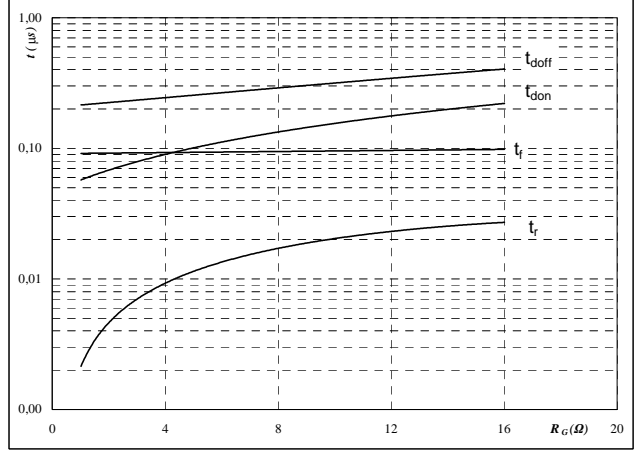
Typical switching times as a function of collector current
 $t = f(I_C)$



With an inductive load at
 $T_j = 25/125 \text{ } ^\circ\text{C}$
 $V_{CE} = 350 \text{ V}$
 $V_{GE} = \pm 15 \text{ V}$
 $R_{gon} = 4 \text{ } \Omega$
 $R_{goff} = 4 \text{ } \Omega$

Figure 10 IGBT

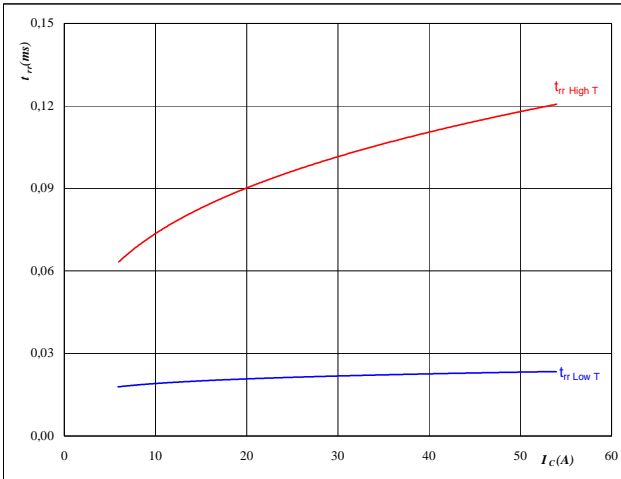
Typical switching times as a function of gate resistor
 $t = f(R_G)$



With an inductive load at
 $T_j = 25/125 \text{ } ^\circ\text{C}$
 $V_{CE} = 350 \text{ V}$
 $V_{GE} = \pm 15 \text{ V}$
 $I_C = 30 \text{ A}$

Figure 11 FWD

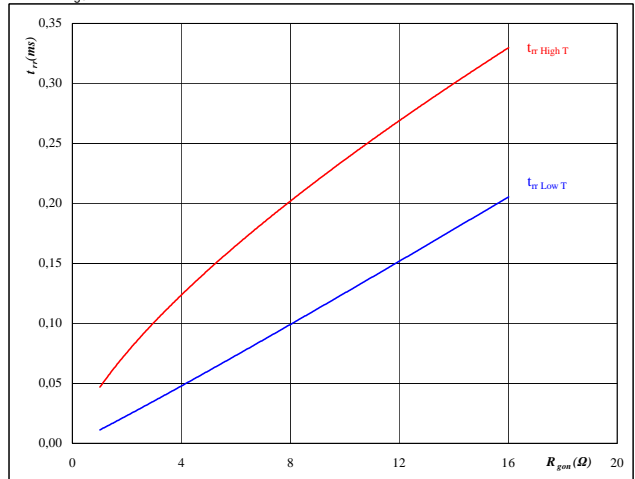
Typical reverse recovery time as a function of collector current
 $t_{rr} = f(I_C)$



At
 $T_j = 25/125 \text{ } ^\circ\text{C}$
 $V_{CE} = 350 \text{ V}$
 $V_{GE} = \pm 15 \text{ V}$
 $R_{gon} = 4 \text{ } \Omega$

Figure 12 FWD

Typical reverse recovery time as a function of IGBT turn on gate resistor
 $t_{rr} = f(R_{gon})$

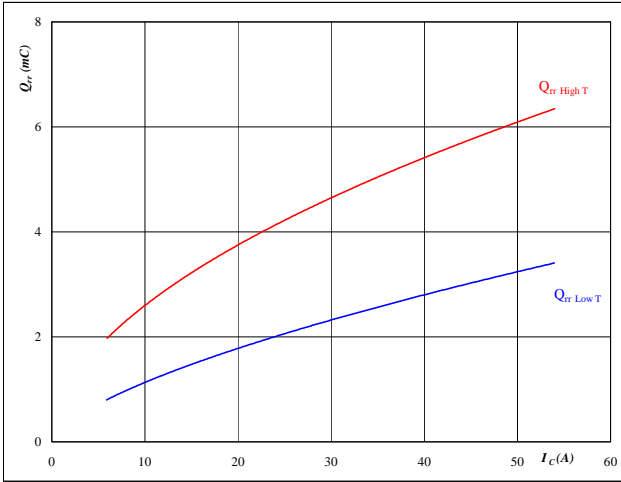


At
 $T_j = 25/125 \text{ } ^\circ\text{C}$
 $V_R = 350 \text{ V}$
 $I_F = 30 \text{ A}$
 $V_{GE} = \pm 15 \text{ V}$

Boost
Figure 13 FWD

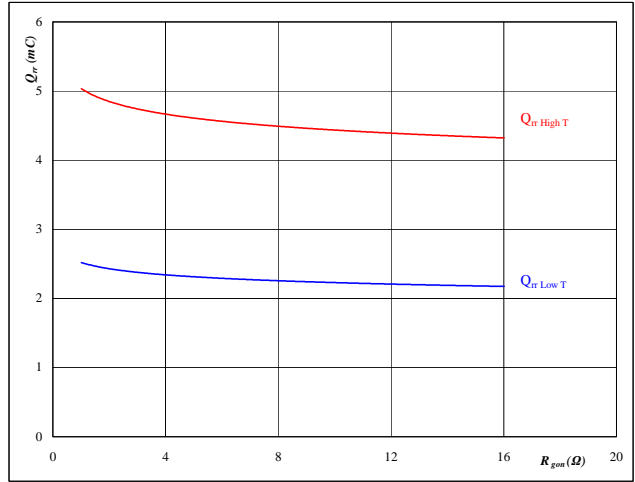
Typical reverse recovery charge as a function of collector current

$$Q_{rr} = f(I_C)$$


At
 $T_j = 25/125 \text{ } ^\circ\text{C}$
 $V_{CE} = 350 \text{ V}$
 $V_{GE} = \pm 15 \text{ V}$
 $R_{gon} = 4 \text{ } \Omega$
Figure 14 FWD

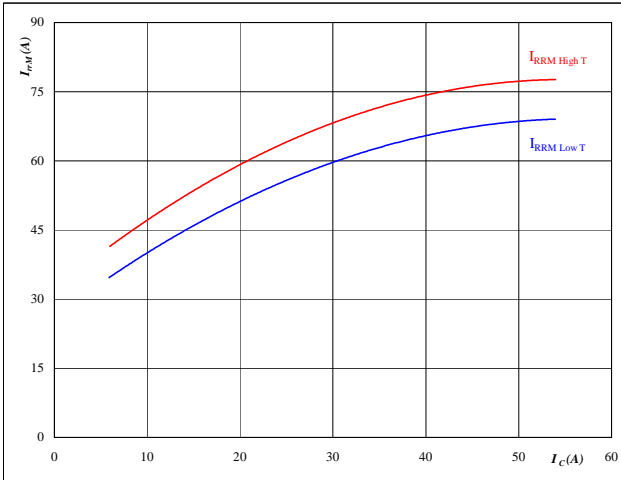
Typical reverse recovery charge as a function of IGBT turn on gate resistor

$$Q_{rr} = f(R_{gon})$$


At
 $T_j = 25/125 \text{ } ^\circ\text{C}$
 $V_R = 350 \text{ V}$
 $I_F = 30 \text{ A}$
 $V_{GE} = \pm 15 \text{ V}$
Figure 15 FWD

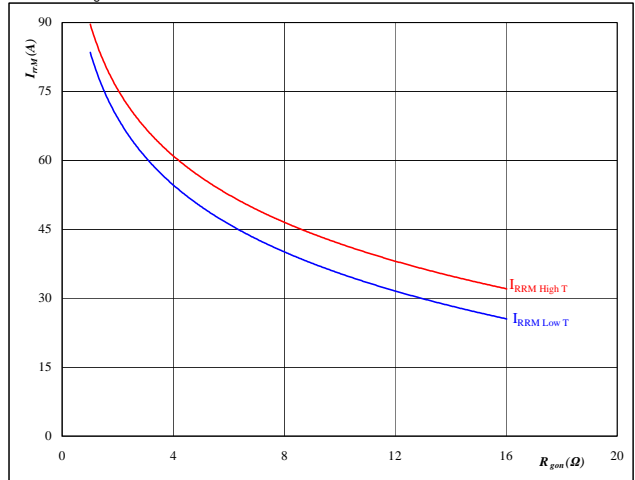
Typical reverse recovery current as a function of collector current

$$I_{RRM} = f(I_C)$$


At
 $T_j = 25/125 \text{ } ^\circ\text{C}$
 $V_{CE} = 350 \text{ V}$
 $V_{GE} = \pm 15 \text{ V}$
 $R_{gon} = 4 \text{ } \Omega$
Figure 16 FWD

Typical reverse recovery current as a function of IGBT turn on gate resistor

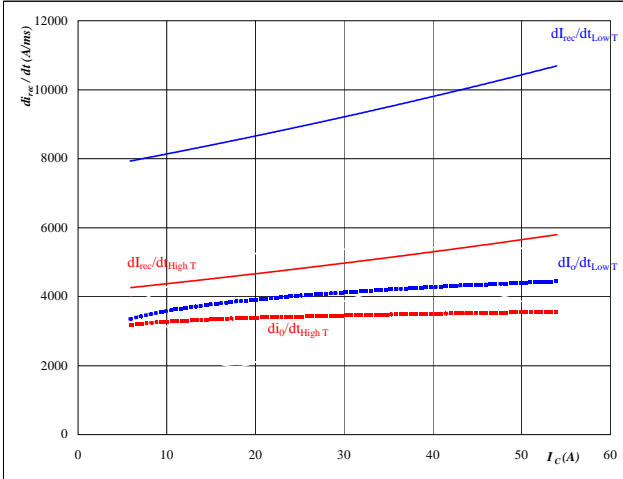
$$I_{RRM} = f(R_{gon})$$


At
 $T_j = 25/125 \text{ } ^\circ\text{C}$
 $V_R = 350 \text{ V}$
 $I_F = 30 \text{ A}$
 $V_{GE} = \pm 15 \text{ V}$

Boost

Figure 17 FWD

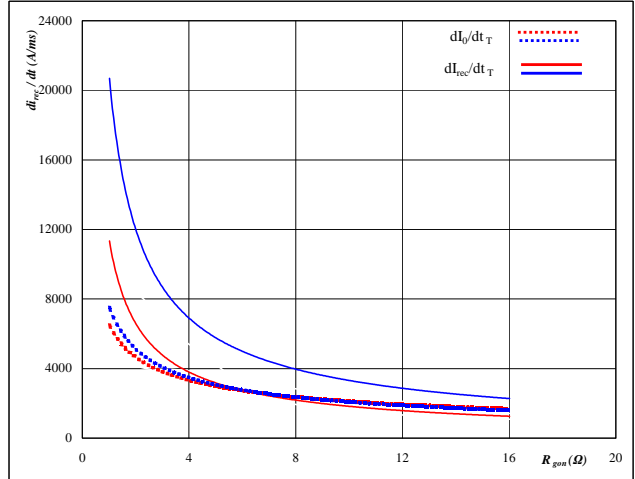
Typical rate of fall of forward and reverse recovery current as a function of collector current
 $di_f/dt, di_{rec}/dt = f(I_c)$



At
T_j = 25/125 °C
V_{CE} = 350 V
V_{GE} = ±15 V
R_{gon} = 4 Ω

Figure 18 FWD

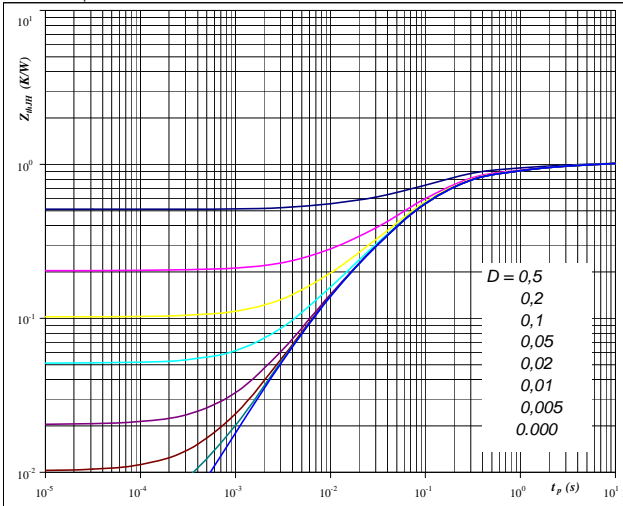
Typical rate of fall of forward and reverse recovery current as a function of reverse recovery current
 $di_f/dt, di_{rec}/dt = f(R_{gon})$



At
T_j = 25/125 °C
V_R = 350 V
I_F = 30 A
V_{GE} = ±15 V

Figure 19 IGBT

IGBT transient thermal impedance as a function of pulse width
 $Z_{thJH} = f(t_p)$



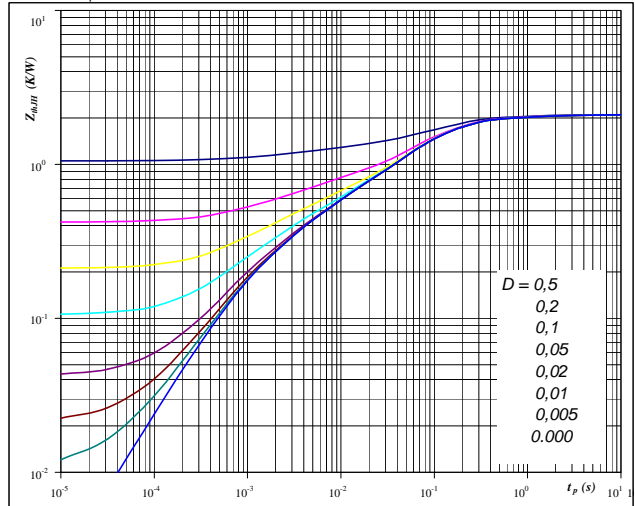
At
D = tp / T
R_{thJH} = 1,02 K/W

IGBT thermal model values

R (C/W)	Tau (s)
0,08	4,30E+00
0,12	9,99E-01
0,47	1,48E-01
0,26	4,85E-02
0,08	8,38E-03
0,04	2,72E-04

Figure 20 FWD

FWD transient thermal impedance as a function of pulse width
 $Z_{thJH} = f(t_p)$



At
D = tp / T
R_{thJH} = 2,11 K/W

FWD thermal model values

R (C/W)	Tau (s)
0,04	6,53E+00
0,11	1,19E+00
0,53	1,77E-01
0,96	6,31E-02
0,30	5,77E-03
0,17	9,51E-04

Boost

Figure 21 IGBT

Power dissipation as a function of heatsink temperature

$$P_{tot} = f(T_h)$$

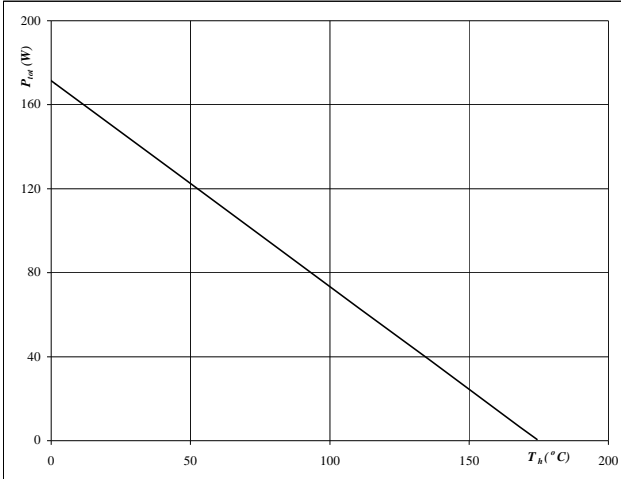

At
 $T_j = 175$ °C

Figure 22 IGBT

Collector current as a function of heatsink temperature

$$I_C = f(T_h)$$

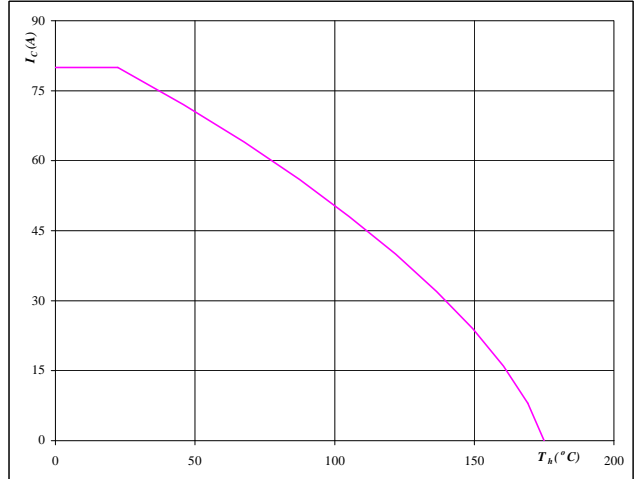

At
 $T_j = 175$ °C
 $V_{GE} = 15$ V

Figure 23 FWD

Power dissipation as a function of heatsink temperature

$$P_{tot} = f(T_h)$$

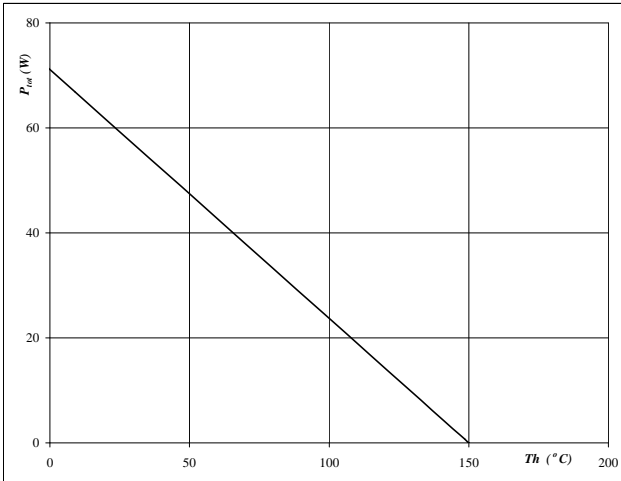
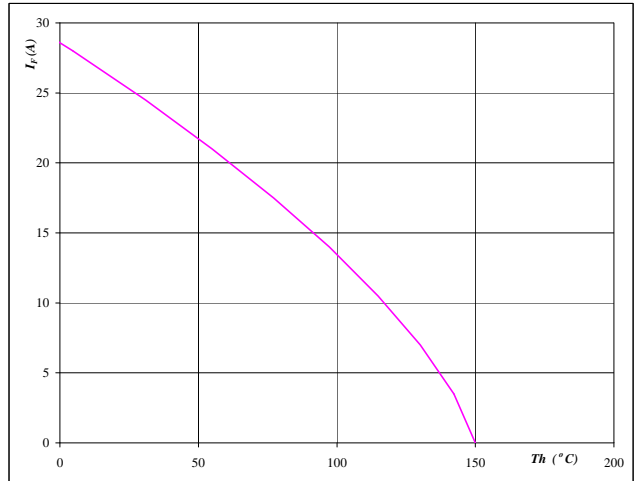

At
 $T_j = 150$ °C

Figure 24 FWD

Forward current as a function of heatsink temperature

$$I_F = f(T_h)$$

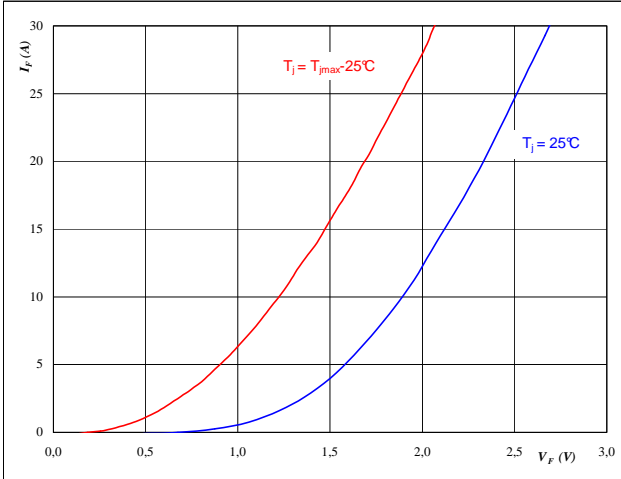

At
 $T_j = 150$ °C

Boost

Figure 25 IGBT Inverse Diode

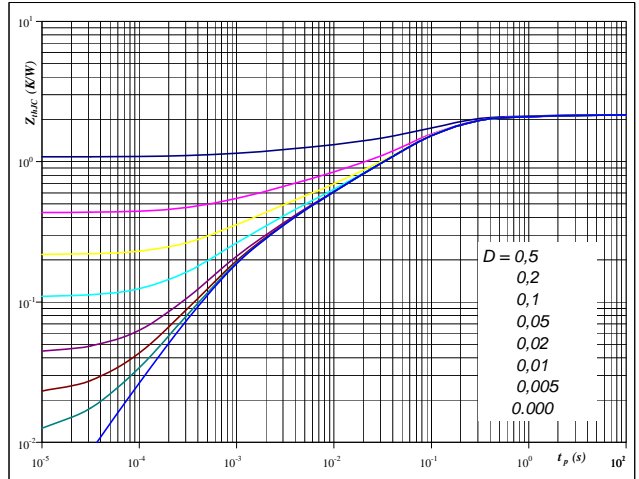
Typical diode forward current as a function of forward voltage

$$I_F = f(V_F)$$


At
 $t_p = 250 \mu s$
Figure 26 IGBT Inverse Diode

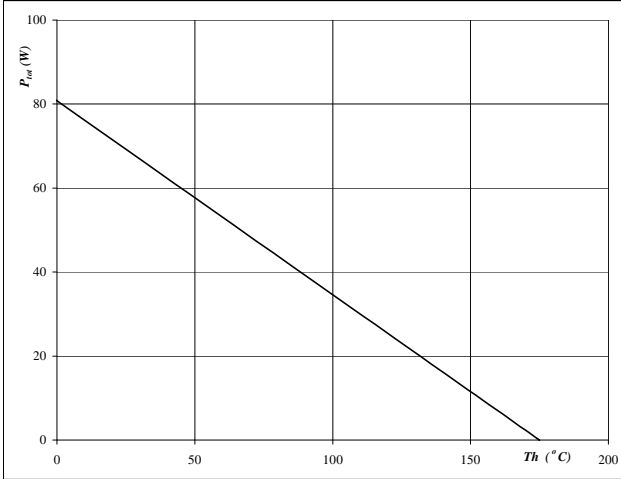
Diode transient thermal impedance as a function of pulse width

$$Z_{th,JH} = f(t_p)$$


At
 $D = t_p / T$
 $R_{th,JH} = 2,17 \text{ K/W}$
Figure 27 IGBT Inverse Diode

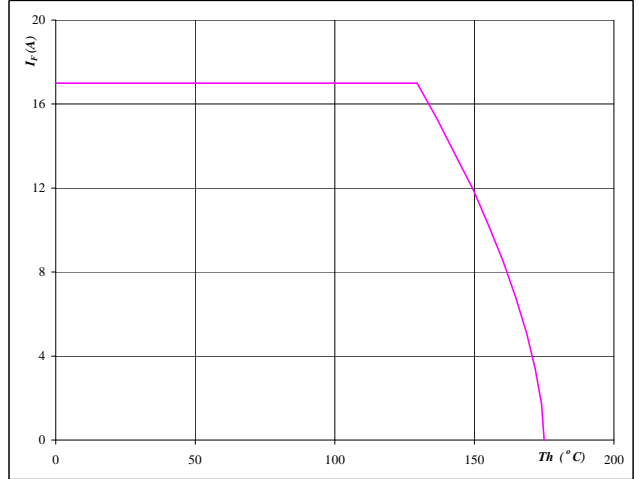
Power dissipation as a function of heatsink temperature

$$P_{tot} = f(T_h)$$


At
 $T_j = 175 \text{ °C}$
Figure 28 IGBT Inverse Diode

Forward current as a function of heatsink temperature

$$I_F = f(T_h)$$

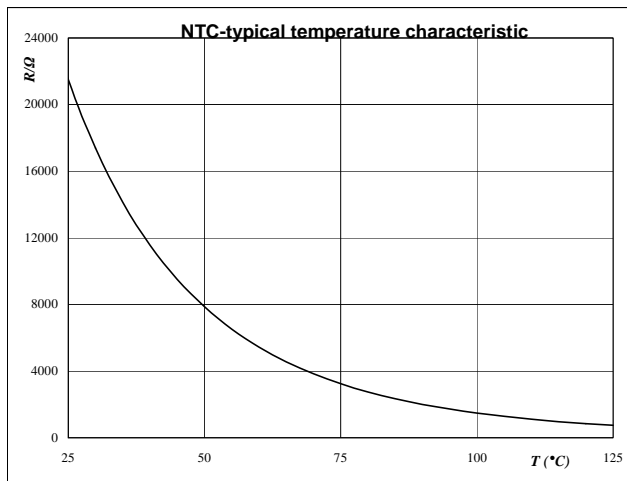

At
 $T_j = 175 \text{ °C}$

Thermistor

Figure 1 Thermistor

Typical NTC characteristic
as a function of temperature

$$R_T = f(T)$$

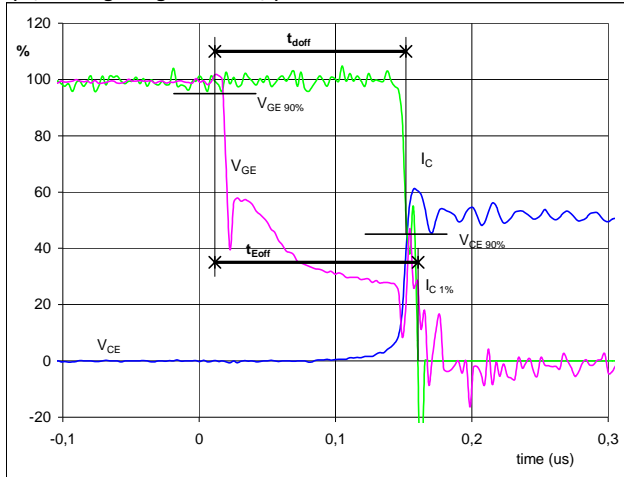


Switching Definitions BUCK MOSFET

General conditions

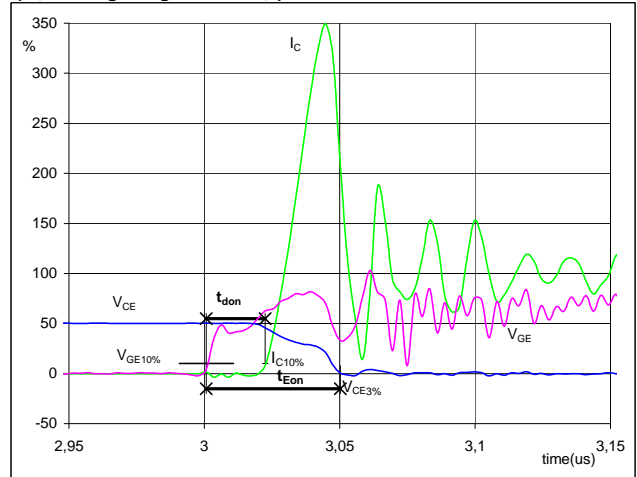
T_j	=	125 °C
$R_{gon\ IGBT}$	=	2 Ω
$R_{goff\ IGBT}$	=	2 Ω

Figure 1 BUCK MOSFET

Turn-off Switching Waveforms & definition of t_{doff} , t_{Eoff}
(t_{Eoff} = integrating time for E_{off})


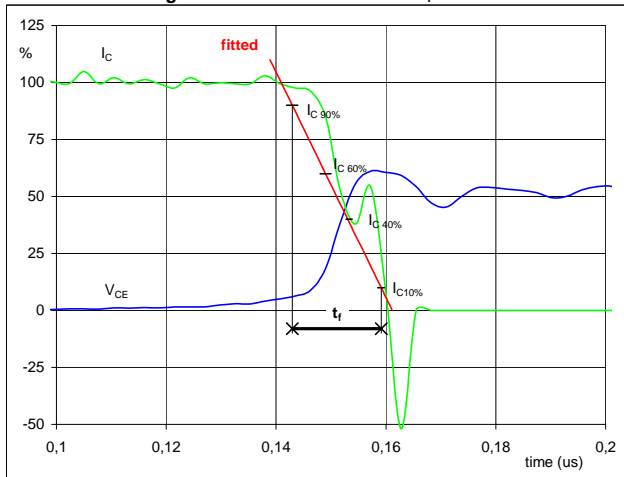
$V_{GE} (0\%) =$	0	V
$V_{GE} (100\%) =$	10	V
$V_C (100\%) =$	700	V
$I_C (100\%) =$	30	A
$t_{doff} =$	0,13	μs
$t_{Eoff} =$	0,15	μs

Figure 2 BUCK MOSFET

Turn-on Switching Waveforms & definition of t_{don} , t_{Eon}
(t_{Eon} = integrating time for E_{on})


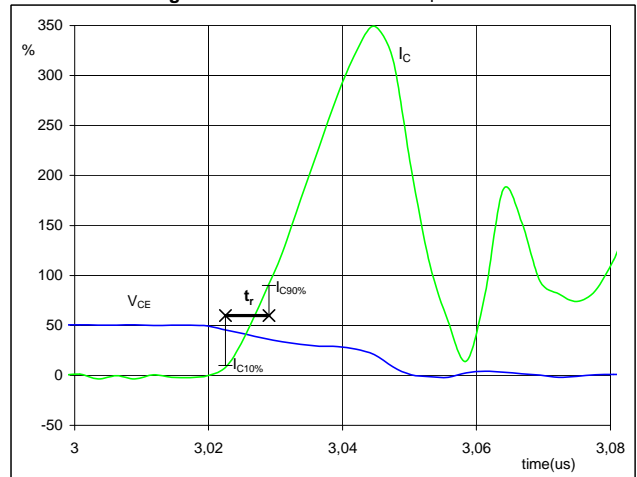
$V_{GE} (0\%) =$	0	V
$V_{GE} (100\%) =$	10	V
$V_C (100\%) =$	700	V
$I_C (100\%) =$	30	A
$t_{don} =$	0,02	μs
$t_{Eon} =$	0,05	μs

Figure 3 BUCK MOSFET

Turn-off Switching Waveforms & definition of t_f


$V_C (100\%) =$	700	V
$I_C (100\%) =$	30	A
$t_f =$	0,007	μs

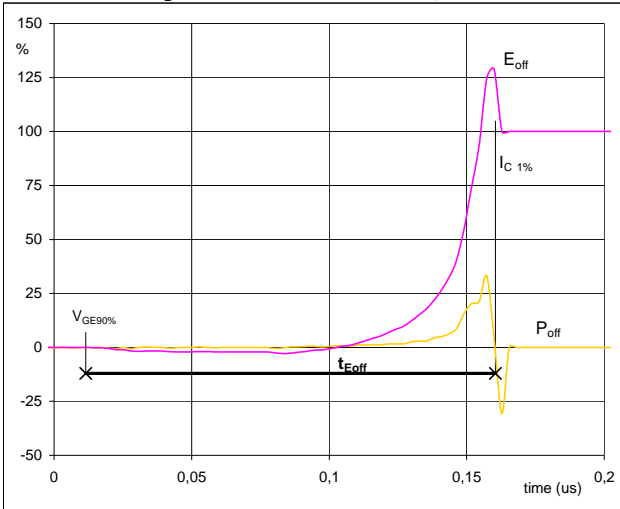
Figure 4 BUCK MOSFET

Turn-on Switching Waveforms & definition of t_r


$V_C (100\%) =$	700	V
$I_C (100\%) =$	30	A
$t_r =$	0,006	μs

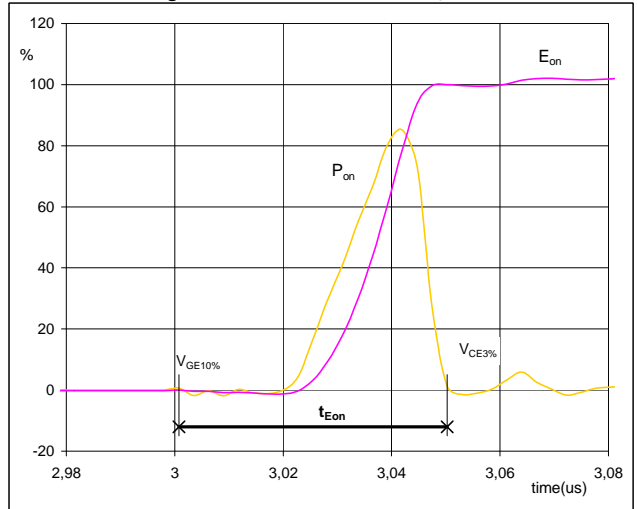
Switching Definitions BUCK MOSFET

Figure 5 BUCK MOSFET

Turn-off Switching Waveforms & definition of t_{Eoff}


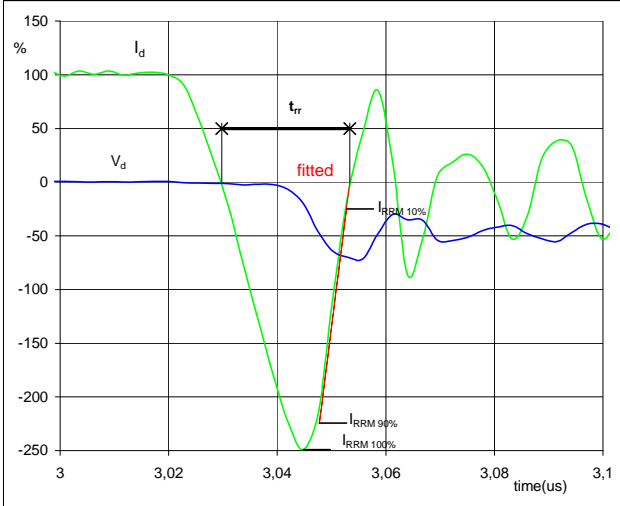
$P_{off} (100\%) = 21,23 \text{ kW}$
 $E_{off} (100\%) = 0,070 \text{ mJ}$
 $t_{Eoff} = 0,15 \text{ } \mu\text{s}$

Figure 6 BUCK MOSFET

Turn-on Switching Waveforms & definition of t_{Eon}


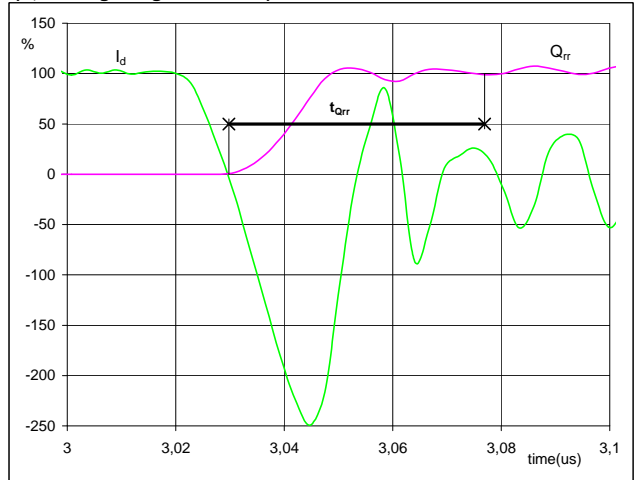
$P_{on} (100\%) = 21,23 \text{ kW}$
 $E_{on} (100\%) = 0,28 \text{ mJ}$
 $t_{Eon} = 0,05 \text{ } \mu\text{s}$

Figure 7 BUCK MOSFET

Turn-off Switching Waveforms & definition of t_{rr}


$V_d (100\%) = 700 \text{ V}$
 $I_d (100\%) = 30 \text{ A}$
 $I_{RRM} (100\%) = -75 \text{ A}$
 $t_{rr} = 0,02 \text{ } \mu\text{s}$

Figure 8 BUCK MOSFET

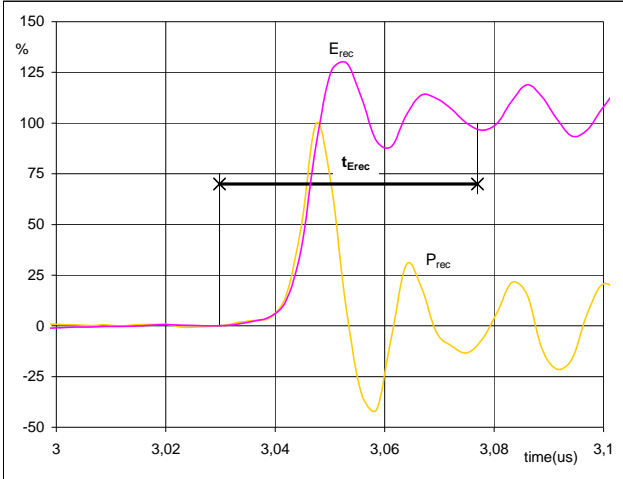
Turn-on Switching Waveforms & definition of t_{Qrr}
(t_{Qrr} = integrating time for Q_{rr})


$I_d (100\%) = 30 \text{ A}$
 $Q_{rr} (100\%) = 0,95 \text{ } \mu\text{C}$
 $t_{Qrr} = 0,05 \text{ } \mu\text{s}$

Switching Definitions BUCK MOSFET

Figure 9 BUCK FWD

Turn-on Switching Waveforms & definition of t_{Erec}
(t_{Erec} = integrating time for E_{rec})



$P_{rec} (100\%) = 21,23 \text{ kW}$
 $E_{rec} (100\%) = 0,14 \text{ mJ}$
 $t_{Erec} = 0,05 \text{ }\mu\text{s}$

Measurement circuits

Figure 11

BUCK stage switching measurement circuit

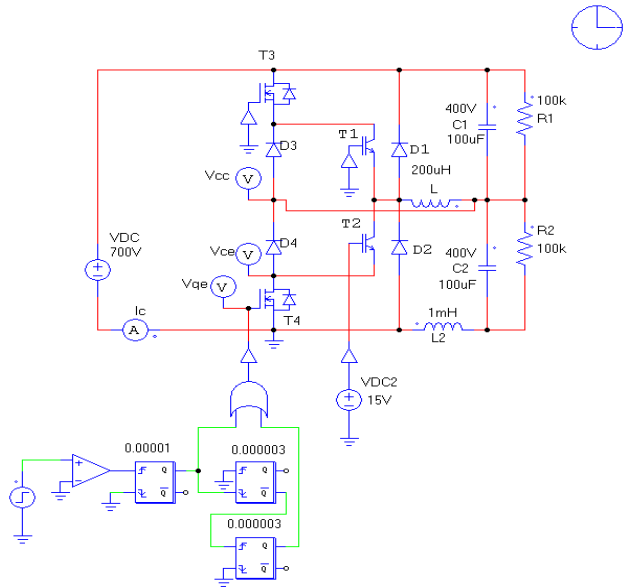
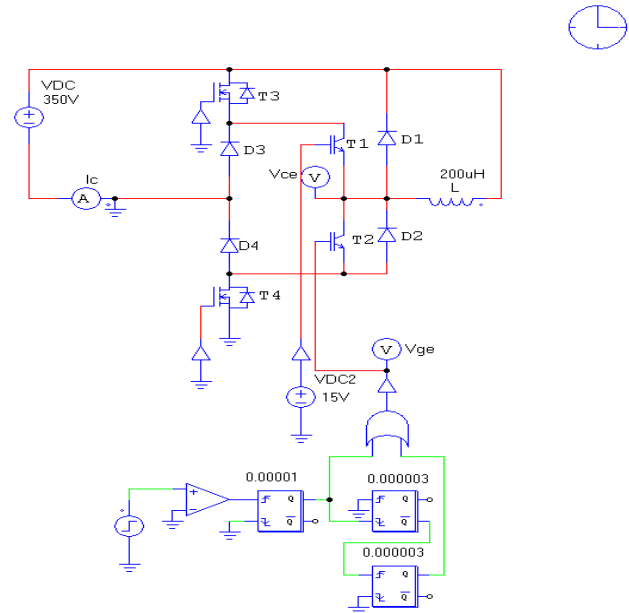


Figure 12

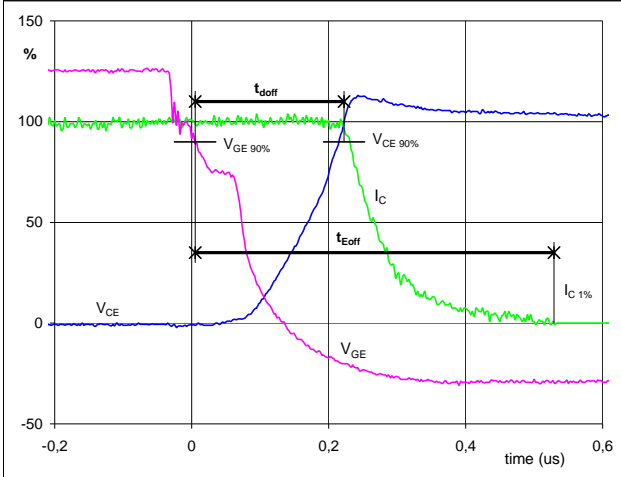
BOOST stage switching measurement circuit



Switching Definitions BOOST

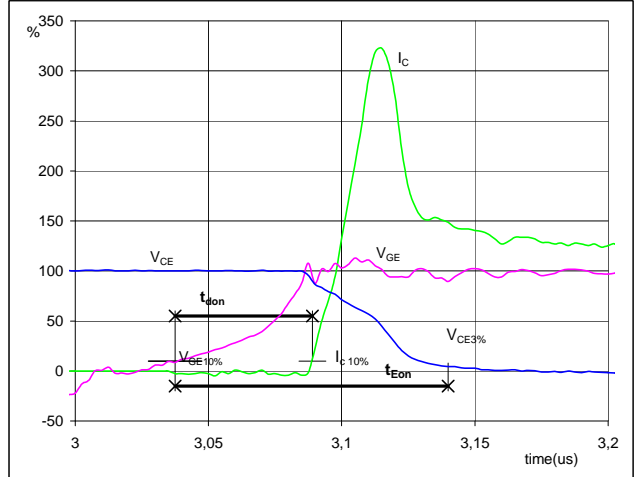
General conditions	
T_j	= 125 °C
$R_{gon\ IGBT}$	= 4 Ω
$R_{goff\ IGBT}$	= 4 Ω

Figure 1 BOOST IGBT

Turn-off Switching Waveforms & definition of t_{doff} , t_{Eoff}
(t_{Eoff} = integrating time for E_{off})


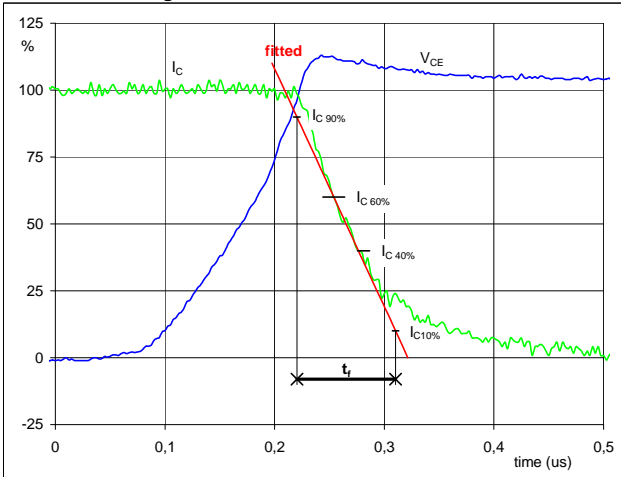
$V_{GE}(0\%) =$	-15	V
$V_{GE}(100\%) =$	15	V
$V_C(100\%) =$	350	V
$I_C(100\%) =$	30	A
$t_{doff} =$	0,24	μs
$t_{Eoff} =$	0,52	μs

Figure 2 BOOST IGBT

Turn-on Switching Waveforms & definition of t_{don} , t_{Eon}
(t_{Eon} = integrating time for E_{on})


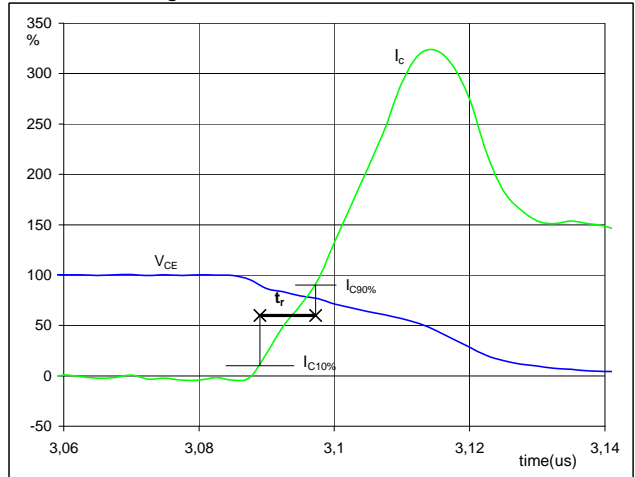
$V_{GE}(0\%) =$	-15	V
$V_{GE}(100\%) =$	15	V
$V_C(100\%) =$	350	V
$I_C(100\%) =$	30	A
$t_{don} =$	0,08	μs
$t_{Eon} =$	0,10	μs

Figure 3 BOOST IGBT

Turn-off Switching Waveforms & definition of t_f


$V_C(100\%) =$	350	V
$I_C(100\%) =$	30	A
$t_f =$	0,090	μs

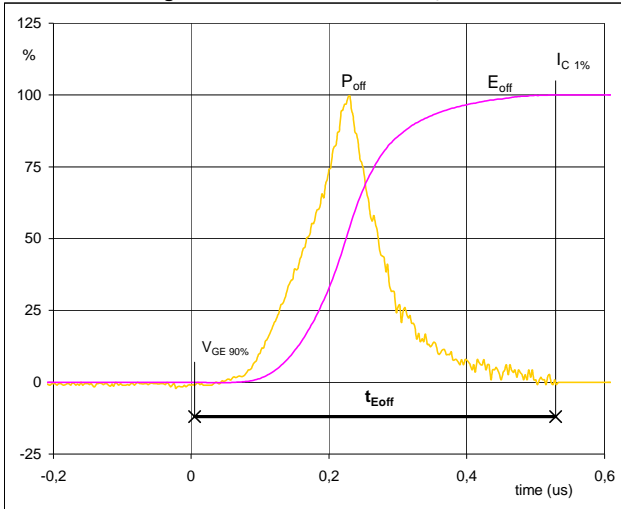
Figure 4 BOOST IGBT

Turn-on Switching Waveforms & definition of t_r


$V_C(100\%) =$	350	V
$I_C(100\%) =$	30	A
$t_r =$	0,01	μs

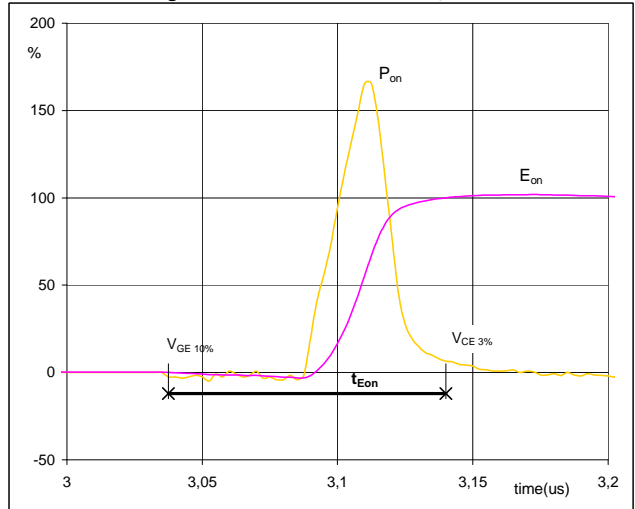
Switching Definitions BOOST

Figure 5 BOOST IGBT

Turn-off Switching Waveforms & definition of t_{Eoff}


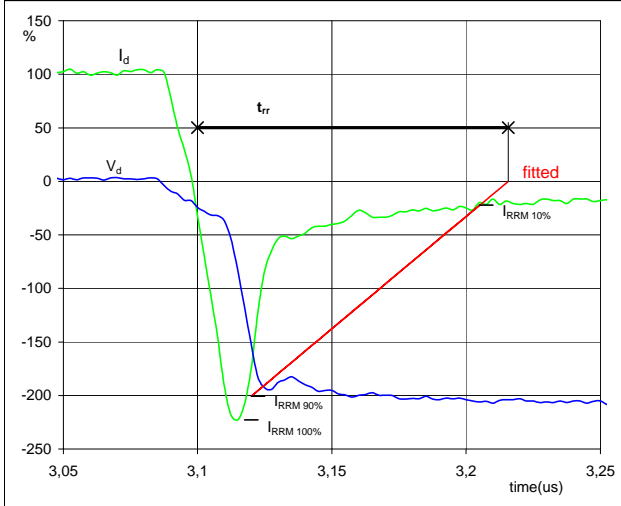
$P_{off} (100\%) = 10,46 \text{ kW}$
 $E_{off} (100\%) = 1,36 \text{ mJ}$
 $t_{Eoff} = 0,52 \text{ }\mu\text{s}$

Figure 6 BOOST IGBT

Turn-on Switching Waveforms & definition of t_{Eon}


$P_{on} (100\%) = 10,46 \text{ kW}$
 $E_{on} (100\%) = 0,39 \text{ mJ}$
 $t_{Eon} = 0,10 \text{ }\mu\text{s}$

Figure 7 BOOST IGBT

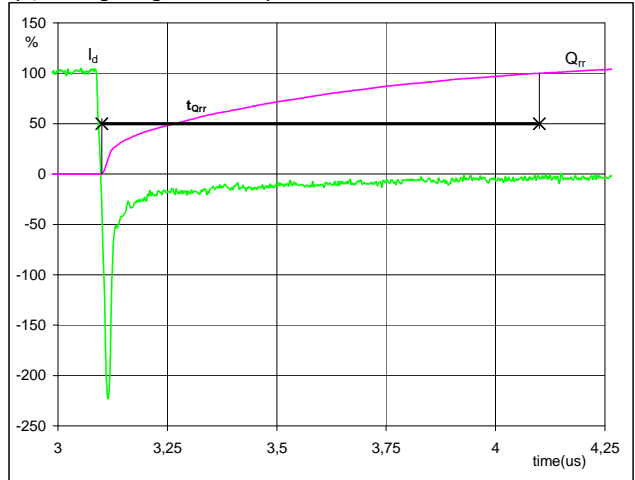
Turn-off Switching Waveforms & definition of t_{rr}


$V_d (100\%) = 350 \text{ V}$
 $I_d (100\%) = 30 \text{ A}$
 $I_{RRM} (100\%) = -67 \text{ A}$
 $t_{rr} = 0,10 \text{ }\mu\text{s}$

Figure 8 BOOST FWD

Turn-on Switching Waveforms & definition of t_{Qrr}

(t_{Qrr} = integrating time for Q_{rr})

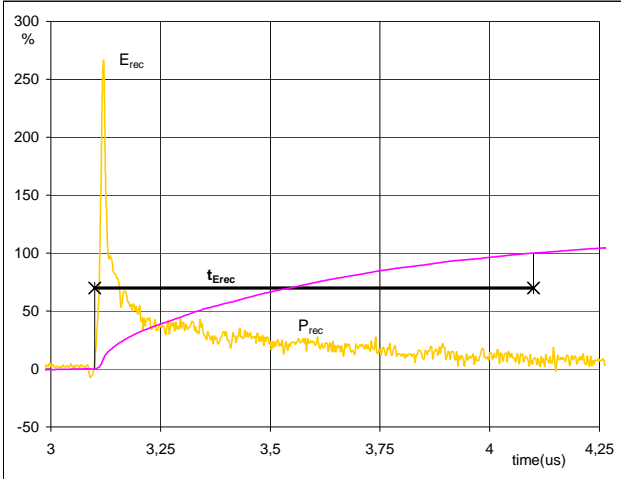


$I_d (100\%) = 30 \text{ A}$
 $Q_{rr} (100\%) = 4,72 \text{ }\mu\text{C}$
 $t_{Qrr} = 1,00 \text{ }\mu\text{s}$

Switching Definitions BOOST

Figure 9 BOOST FWD

Turn-on Switching Waveforms & definition of t_{Erec}
 (t_{Erec} = integrating time for E_{rec})

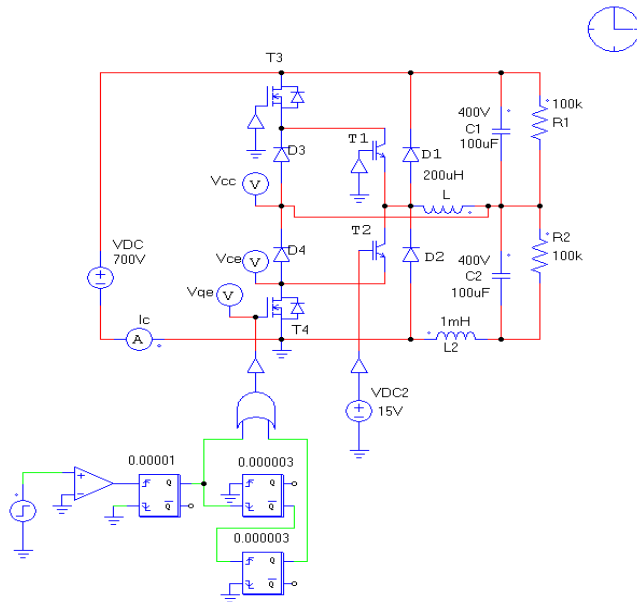


$P_{rec} (100\%) = 10,46 \text{ kW}$
 $E_{rec} (100\%) = 1,45 \text{ mJ}$
 $t_{Erec} = 1,00 \text{ } \mu\text{s}$

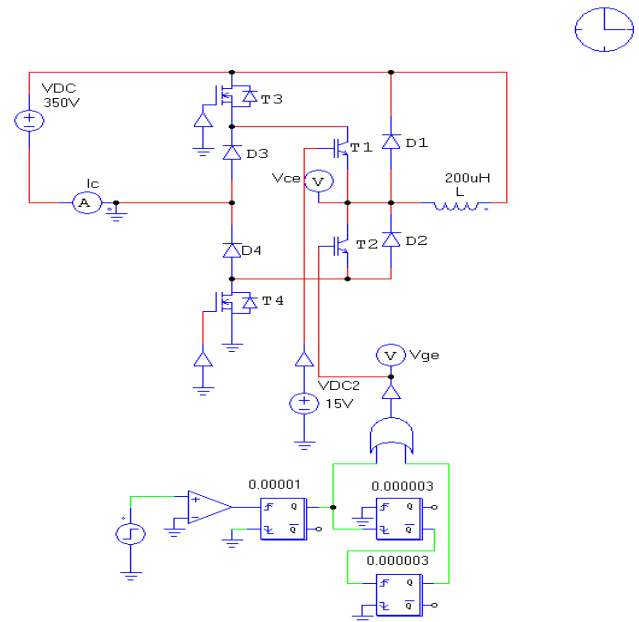
Measurement circuits

Figure 11

BUCK stage switching measurement circuit

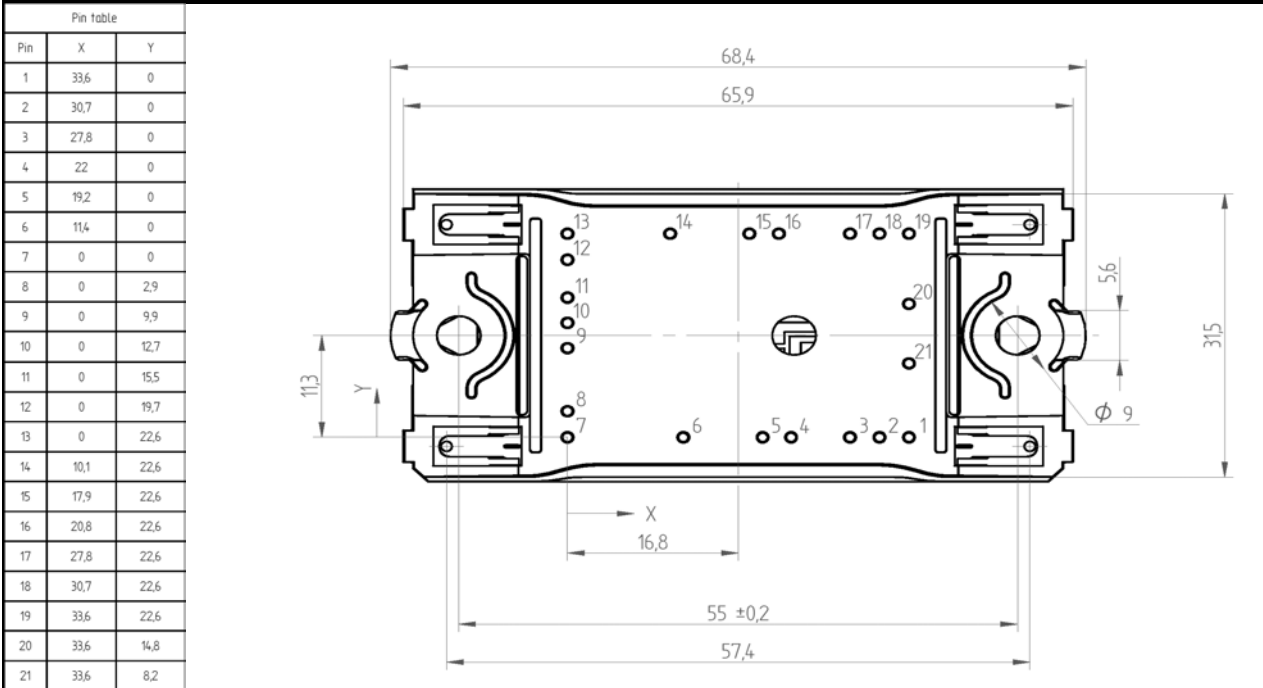
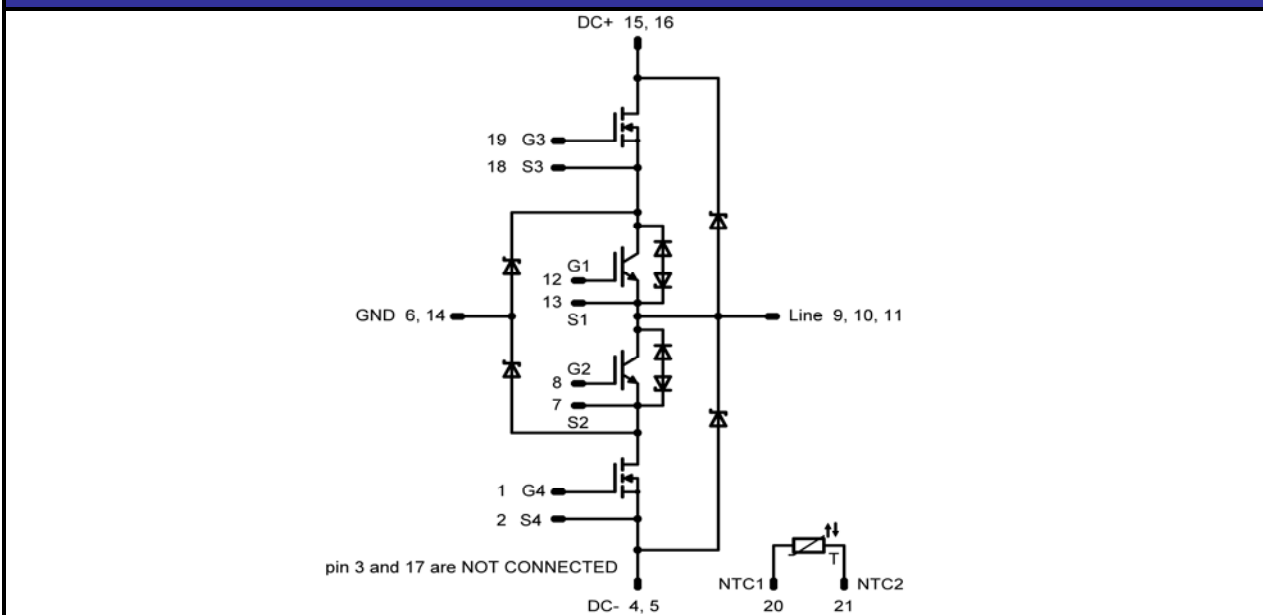

Figure 12

BOOST stage switching measurement circuit



Ordering Code and Marking - Outline - Pinout
Ordering Code & Marking

Version	Ordering Code	in DataMatrix as	in packaging barcode as
w/o thermal paste 12mm housing solder pin	10-FZ06NRA041FS03-P965F78	P965F78	P965F78
w/o thermal paste 12mm housing Press-fit pin	10-PZ06NRA041FS03-P965F78Y	P965F78Y	P965F78Y

Outline

Pinout


DISCLAIMER

The information given in this datasheet describes the type of component and does not represent assured characteristics. For tested values please contact Vincotech. Vincotech reserves the right to make changes without further notice to any products herein to improve reliability, function or design. Vincotech does not assume any liability arising out of the application or use of any product or circuit described herein; neither does it convey any license under its patent rights, nor the rights of others.

LIFE SUPPORT POLICY

Vincotech products are not authorised for use as critical components in life support devices or systems without the express written approval of Vincotech.

As used herein:

1. Life support devices or systems are devices or systems which, (a) are intended for surgical implant into the body, or (b) support or sustain life, or (c) whose failure to perform when properly used in accordance with instructions for use provided in labelling can be reasonably expected to result in significant injury to the user.
2. A critical component is any component of a life support device or system whose failure to perform can be reasonably expected to cause the failure of the life support device or system, or to affect its safety or effectiveness.