

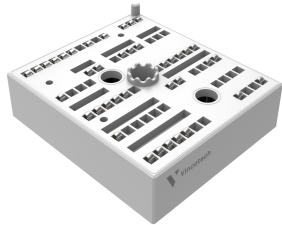

MiniSKiiP PACK 2	1200 V / 35 A
<p>Topology features</p> <ul style="list-style-type: none">• Inverter• Kelvin Emitter for improved switching performance• Temperature sensor	<p>MiniSKiiP® 2 16 mm housing</p>  <p>Schematic</p> 
<p>Component features</p> <ul style="list-style-type: none">• Easy paralleling• Low turn-off losses• Low collector emitter saturation voltage• Positive temperature coefficient• Short tail current	
<p>Housing features</p> <ul style="list-style-type: none">• Base isolation: Al₂O₃• Easy assembly in one mounting step• Flexible PCB design w/o pin holes• Rugged solderless spring contacts	
<p>Extra features</p> <ul style="list-style-type: none">• Equivalent: SKiiP 24AC12T4V1	
<p>Target applications</p> <ul style="list-style-type: none">• Industrial Drives	
<p>Types</p> <ul style="list-style-type: none">• V23990-K238-F40	

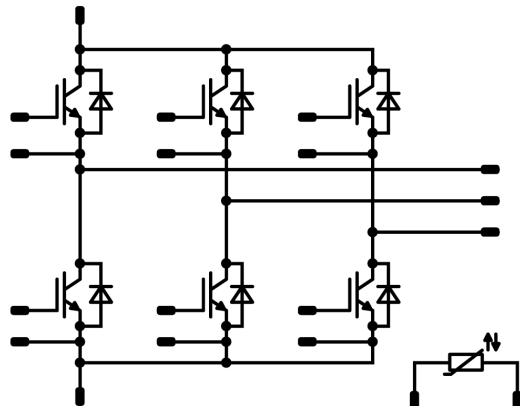

Vincotech

Maximum Ratings

$T_j = 25\text{ °C}$, unless otherwise specified

Parameter	Symbol	Conditions	Value	Unit
Inverter Switch				
Collector-emitter voltage	V_{CES}		1200	V
Collector current (DC current)	I_C	$T_j = T_{jmax}$ $T_s = 80\text{ °C}$	46	A
Repetitive peak collector current	I_{CRM}	t_p limited by T_{jmax}	105	A
Total power dissipation	P_{tot}	$T_j = T_{jmax}$ $T_s = 80\text{ °C}$	134	W
Gate-emitter voltage	V_{GES}		±20	V
Short circuit ratings	t_{SC}	$V_{GE} = 15\text{ V}$, $V_{CC} = 800\text{ V}$ $T_j = 150\text{ °C}$	10	µs
Maximum junction temperature	T_{jmax}		175	°C

Inverter Diode				
Peak repetitive reverse voltage	V_{RRM}		1200	V
Forward current (DC current)	I_F	$T_j = T_{jmax}$ $T_s = 80\text{ °C}$	40	A
Surge (non-repetitive) forward current	I_{FSM}	Single Half Sine Wave, $t_p = 10\text{ ms}$ $T_j = 150\text{ °C}$	170	A
Surge current capability	I^2t		145	A ² s
Total power dissipation	P_{tot}	$T_j = T_{jmax}$ $T_s = 80\text{ °C}$	99	W
Maximum junction temperature	T_{jmax}		175	°C

Module Properties

Thermal Properties

Storage temperature	T_{stg}		-40...+125	°C
Operation temperature under switching condition	T_{jop}		-40...+($T_{jmax} - 25$)	°C

Isolation Properties

Isolation voltage	V_{isol}	DC Test Voltage* $t_p = 2\text{ s}$	5500	V
Isolation voltage	V_{isol}	AC Voltage $t_p = 1\text{ min}$	2500	V
Creepage distance		With std lid For more informations see handling instructions	6,3	mm
Clearance		With std lid For more informations see handling instructions	6,3	mm
Comparative Tracking Index	CTI		≥ 600	

*100 % tested in production



Characteristic Values

Parameter	Symbol	Conditions					Values			Unit
		V_{GE} [V] V_{GS} [V]	V_{CE} [V] V_{DS} [V] V_F [V]	I_C [A] I_D [A] I_F [A]	T_j [°C]	Min	Typ	Max		

Inverter Switch

Static

Gate-emitter threshold voltage	$V_{GE(th)}$	$V_{CE} = V_{GE}$			0,0012	25	5,3	5,8	6,3	V
Collector-emitter saturation voltage	$V_{CE(sat)}$		15		35	25 150	1,58	1,9 2,33	2,07 ⁽¹⁾	V
Collector-emitter cut-off current	I_{CES}		0	1200		25			5	μA
Gate-emitter leakage current	I_{GES}		20	0		25			120	nA
Internal gate resistance	r_g							None		Ω
Input capacitance	C_{ies}	$f = 1 \text{ Mhz}$	0	25		25		2000		pF
Reverse transfer capacitance	C_{res}							70		pF
Gate charge	Q_g		±15		0	25		270		nC

Thermal

Thermal resistance junction to sink ⁽²⁾	$R_{th(j-s)}$	$\lambda_{paste} = 2,5 \text{ W/mK}$ (HPTP)						0,71		K/W
--	---------------	--	--	--	--	--	--	------	--	-----

Dynamic

Turn-on delay time	$t_{d(on)}$	$R_{gon} = 16 \Omega$ $R_{goff} = 16 \Omega$	±15	600	35	25		95,6		ns
Rise time	t_r					150		95,4		ns
						25		21,6		ns
Turn-off delay time	$t_{d(off)}$					150		27,2		ns
						25		217,8		ns
Fall time	t_f					150		291,2		ns
						25		91,58		ns
Turn-on energy (per pulse)	E_{on}	150		113,33		mWs				
		25		1,95		mWs				
Turn-off energy (per pulse)	E_{off}	150		3,07		mWs				
		25		1,95		mWs				
						150		3,28		mWs



Vincotech

V23990-K238-F40
datasheet

Characteristic Values

Parameter	Symbol	Conditions					Values			Unit
		V_{GE} [V] V_{GS} [V]	V_{CE} [V] V_{DS} [V] V_F [V]	I_C [A] I_D [A] I_F [A]	T_j [°C]	Min	Typ	Max		

Inverter Diode

Static

Forward voltage	V_F				35	25 150		2,37 2,35	2,62 ⁽¹⁾ 2,62 ⁽¹⁾	V
Reverse leakage current	I_R	$V_i = 1200$ V				25 150			60 5500	μA

Thermal

Thermal resistance junction to sink ⁽²⁾	$R_{th(j-s)}$	$\lambda_{paste} = 2,5$ W/mK (HPTP)						0,96		K/W
--	---------------	--	--	--	--	--	--	------	--	-----

Dynamic

Peak recovery current	I_{RRM}	$di/dt=1692$ A/μs $di/dt=1557$ A/μs	±15	600	35	25		30,34		A
Reverse recovery time	t_{rr}					150		40,2		ns
						25		126,24		
Recovered charge	Q_r					150		291,92		μC
						25		2,06		
Reverse recovered energy	E_{rec}					150		5,34		mWs
		25		0,694						
Peak rate of fall of recovery current	$(di_{rr}/dt)_{max}$	150		1074		A/μs				
		25		256,85						



Characteristic Values

Parameter	Symbol	Conditions					Values			Unit
		V_{GS} [V]	V_{GE} [V]	V_{DS} [V]	V_{CE} [V]	I_D [A]	I_C [A]	T_j [°C]	Min	

Thermistor

Static

Rated resistance	R					25		1		kΩ
Deviation of R_{100}	$A_{R/R}$	$R_{100} = 1670 \Omega$				100	-2		2	%
Maximum Current	I_{max}							3		mA
Power dissipation constant	d					25		0,76		mW/K
A-value	A							$7,635 \times 10^{-3}$		1/K
B-value	B							$1,73 \times 10^{-5}$		1/K ²
Vincotech Thermistor Reference									E	

⁽¹⁾ Value at chip level

⁽²⁾ Only valid with pre-applied Vincotech thermal interface material.



Inverter Switch Characteristics

figure 1. IGBT

Typical output characteristics

$$I_C = f(V_{CE})$$

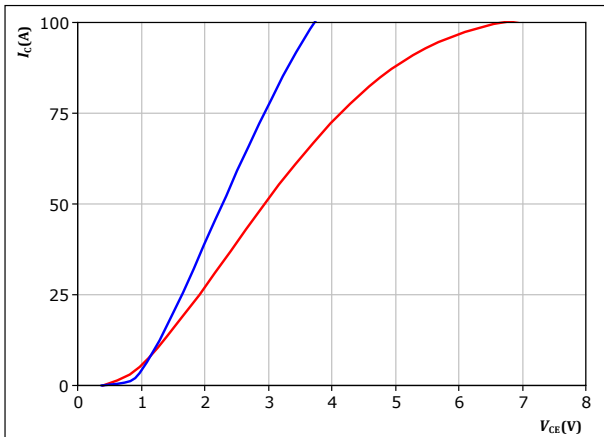

$t_p = 250 \mu s$
 $V_{GE} = 15 V$
 $T_j:$ — 25 °C
— 150 °C

figure 2. IGBT

Typical output characteristics

$$I_C = f(V_{CE})$$

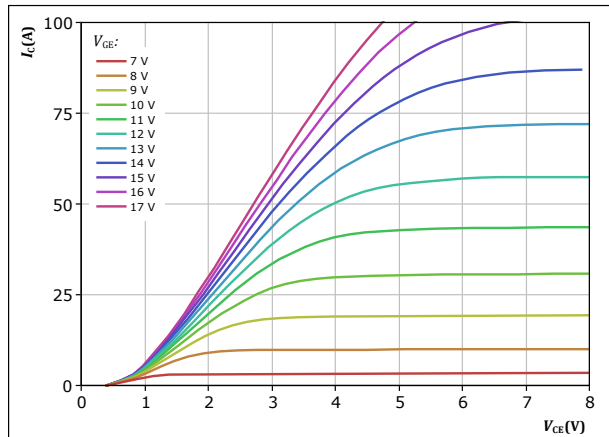

$t_p = 250 \mu s$
 $T_j = 150 \text{ } ^\circ C$
 V_{GE} from 7 V to 17 V in steps of 1 V

figure 3. IGBT

Typical transfer characteristics

$$I_C = f(V_{GE})$$

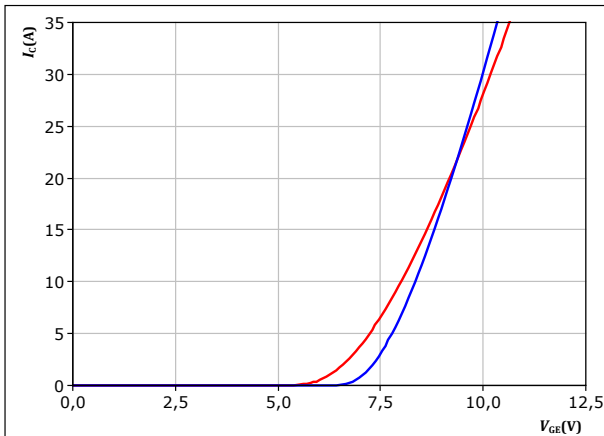

$t_p = 250 \mu s$
 $V_{CE} = 10 V$
 $T_j:$ — 25 °C
— 150 °C

figure 4. IGBT

Transient thermal impedance as a function of pulse width

$$Z_{th(j-s)} = f(t_p)$$

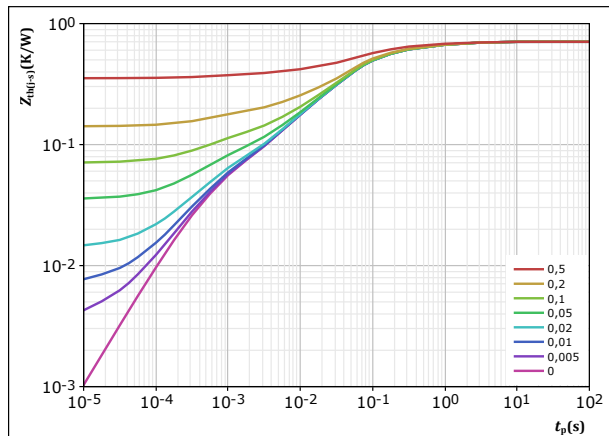

$D = t_p / T$
 $R_{th(j-s)} = 0,707 \text{ K/W}$
IGBT thermal model values

R (K/W)	τ (s)
6,31E-02	1,71E+00
1,38E-01	2,62E-01
3,83E-01	5,28E-02
7,97E-02	6,74E-03
4,34E-02	5,14E-04



Inverter Switch Characteristics

figure 5. IGBT

Safe operating area

$$I_C = f(V_{CE})$$

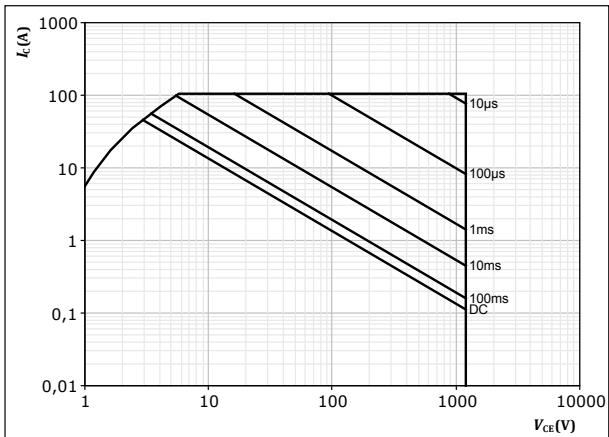

$D =$ single pulse

$T_s = 80$ °C

$V_{GE} = 15$ V

$T_j = T_{jmax}$



Inverter Diode Characteristics

figure 6. FWD

Typical forward characteristics

$$I_F = f(V_F)$$

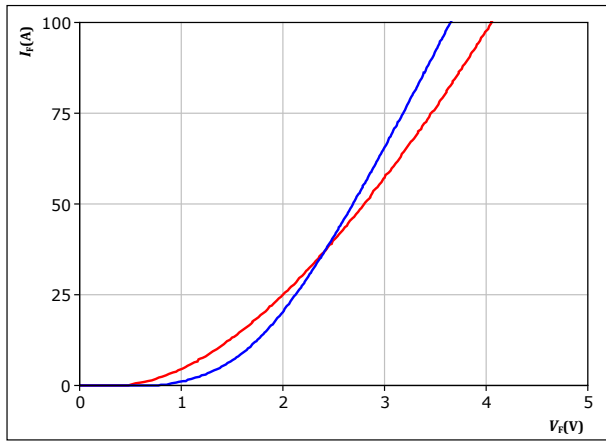

$t_p = 250 \mu s$
 T_j : — 25 °C
 — 150 °C

figure 7. FWD

Transient thermal impedance as a function of pulse width

$$Z_{th(j-s)} = f(t_p)$$

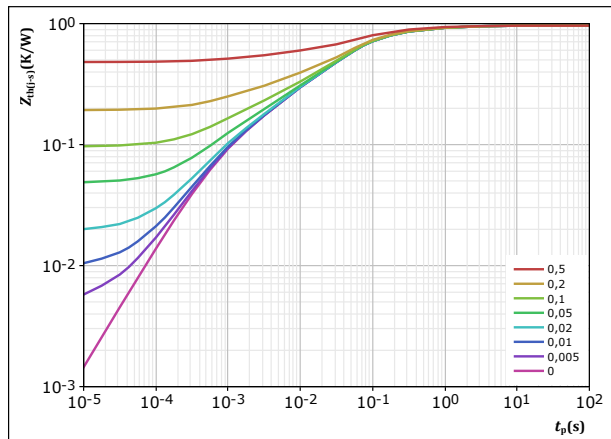

$D = t_p / T$
 $R_{th(j-s)} = 0,962 \text{ K/W}$
 FWD thermal model values

R (K/W)	τ (s)
6,74E-02	1,72E+00
2,35E-01	1,93E-01
4,53E-01	4,29E-02
1,37E-01	4,58E-03
7,04E-02	6,78E-04



Thermistor Characteristics

figure 8. Thermistor

Typical PTC characteristic as function of temperature

$$R_T = f(T)$$

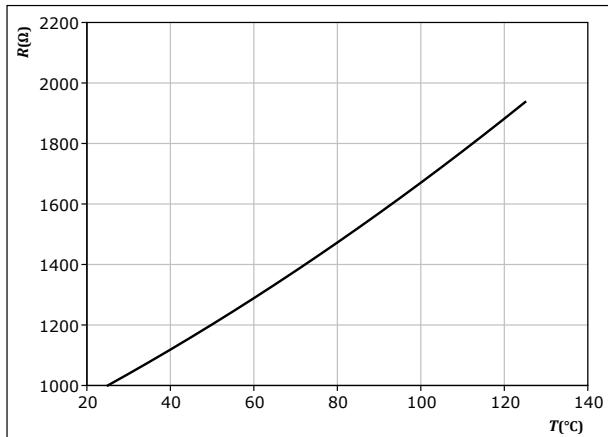



Inverter Switching Characteristics

figure 9. IGBT

Typical switching energy losses as a function of collector current
 $E = f(I_c)$

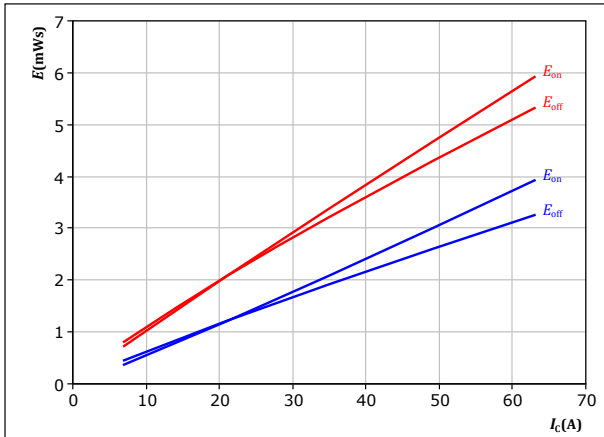

With an inductive load at

$V_{CE} = 600$ V
 $V_{GE} = \pm 15$ V
 $R_{g(on)} = 16$ Ω
 $R_{g(off)} = 16$ Ω

T_j : — 25 °C
 — 150 °C

figure 10. IGBT

Typical switching energy losses as a function of IGBT turn on gate resistor
 $E = f(R_g)$

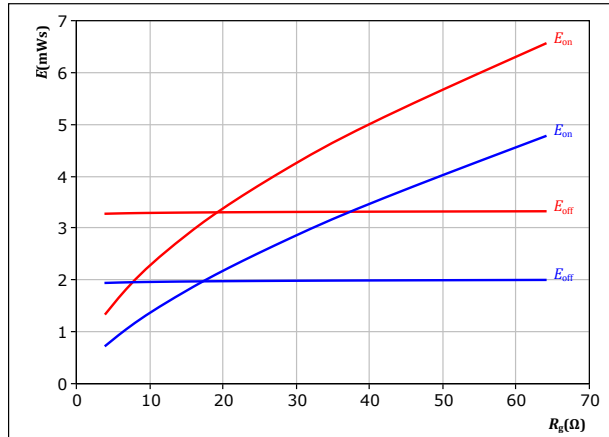

With an inductive load at

$V_{CE} = 600$ V
 $V_{GE} = \pm 15$ V
 $I_c = 35$ A

T_j : — 25 °C
 — 150 °C

figure 11. FWD

Typical reverse recovered energy loss as a function of collector current
 $E_{rec} = f(I_c)$

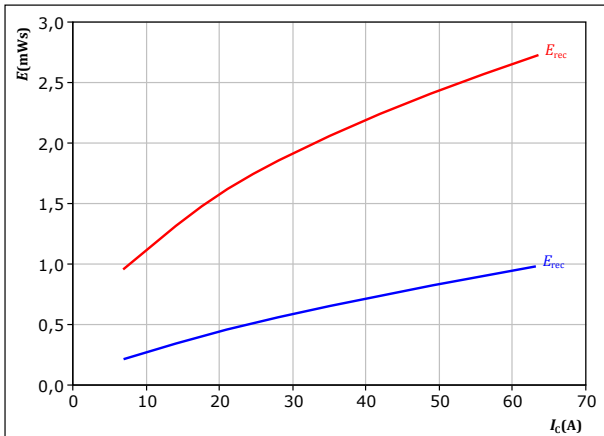

With an inductive load at

$V_{CE} = 600$ V
 $V_{GE} = \pm 15$ V
 $R_{g(on)} = 16$ Ω

T_j : — 25 °C
 — 150 °C

figure 12. FWD

Typical reverse recovered energy loss as a function of IGBT turn on gate resistor
 $E_{rec} = f(R_g)$

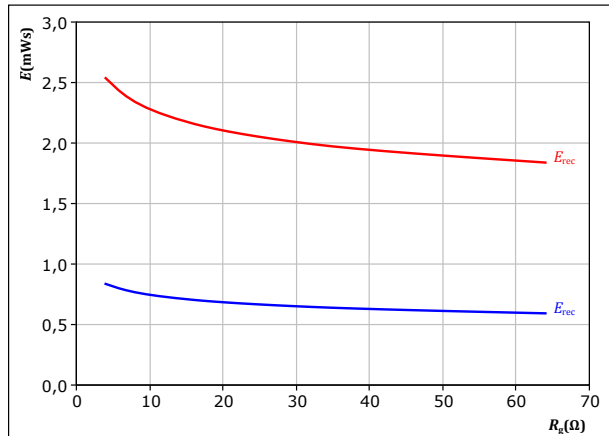

With an inductive load at

$V_{CE} = 600$ V
 $V_{GE} = \pm 15$ V
 $I_c = 35$ A

T_j : — 25 °C
 — 150 °C



Inverter Switching Characteristics

figure 13. IGBT

Typical switching times as a function of collector current
 $t = f(I_c)$

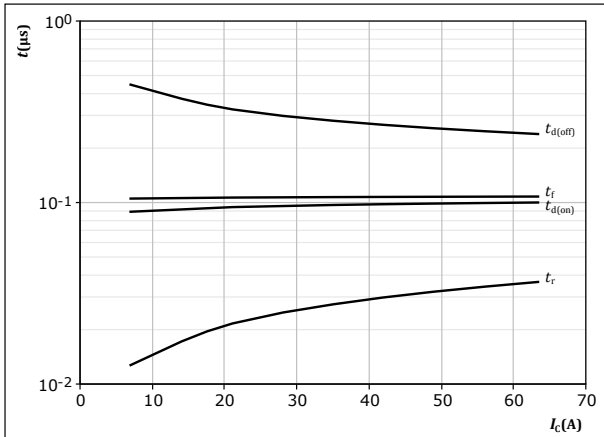

With an inductive load at
 $T_j = 150 \text{ }^\circ\text{C}$
 $V_{CE} = 600 \text{ V}$
 $V_{GE} = \pm 15 \text{ V}$
 $R_{gon} = 16 \text{ } \Omega$
 $R_{goff} = 16 \text{ } \Omega$

figure 14. IGBT

Typical switching times as a function of IGBT turn on gate resistor
 $t = f(R_g)$

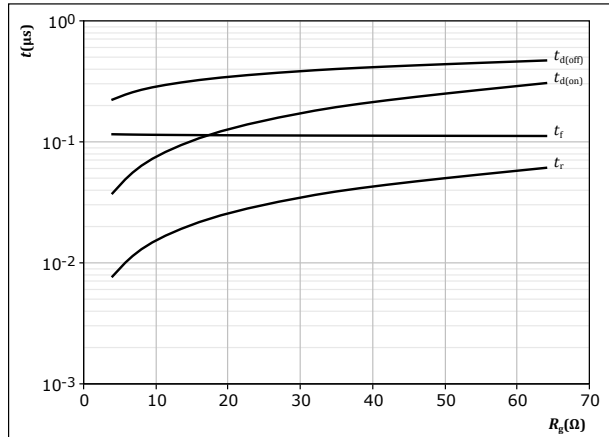

With an inductive load at
 $T_j = 150 \text{ }^\circ\text{C}$
 $V_{CE} = 600 \text{ V}$
 $V_{GE} = \pm 15 \text{ V}$
 $I_c = 35 \text{ A}$

figure 15. FWD

Typical reverse recovery time as a function of collector current
 $t_{rr} = f(I_c)$

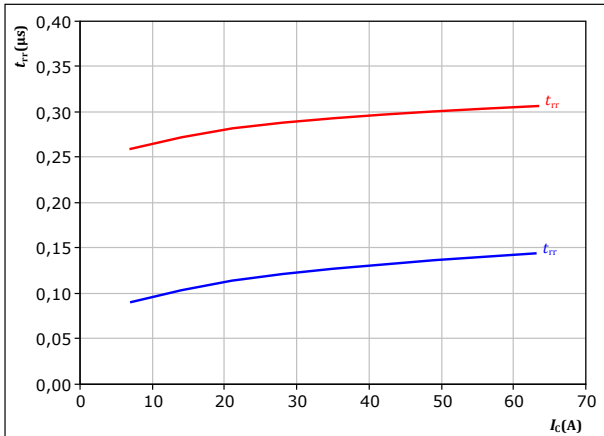

With an inductive load at
 $V_{CE} = 600 \text{ V}$
 $V_{GE} = \pm 15 \text{ V}$
 $R_{gon} = 16 \text{ } \Omega$
 T_j : — 25 °C
 — 150 °C

figure 16. FWD

Typical reverse recovery time as a function of IGBT turn on gate resistor
 $t_{rr} = f(R_{gon})$

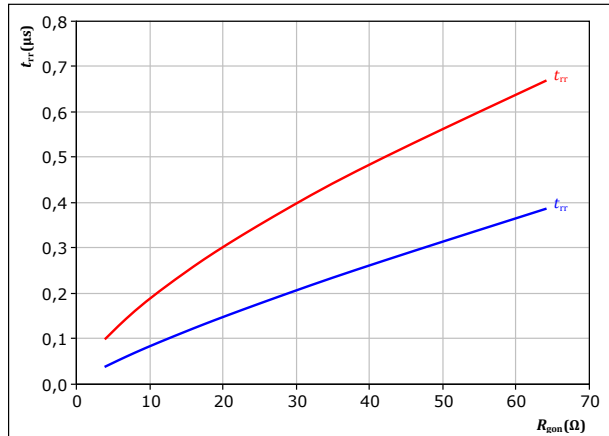

With an inductive load at
 $V_{CE} = 600 \text{ V}$
 $V_{GE} = \pm 15 \text{ V}$
 $I_c = 35 \text{ A}$
 T_j : — 25 °C
 — 150 °C



Inverter Switching Characteristics

figure 17. FWD

Typical recovered charge as a function of collector current

$$Q_r = f(I_c)$$

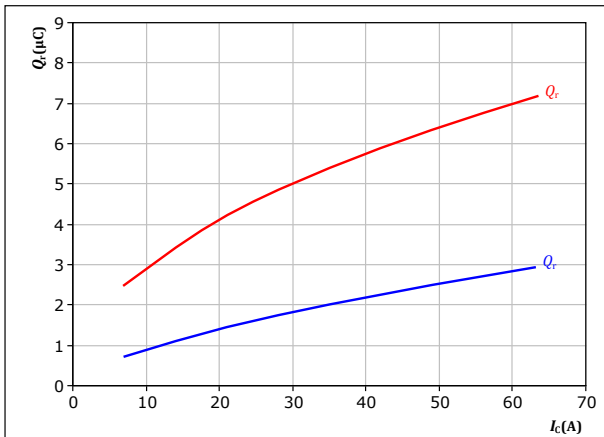

With an inductive load at

$V_{CE} = 600$ V
 $V_{GE} = \pm 15$ V
 $R_{gon} = 16$ Ω

T_j : — 25 °C
— 150 °C

figure 18. FWD

Typical recovered charge as a function of IGBT turn on gate resistor

$$Q_r = f(R_{gon})$$

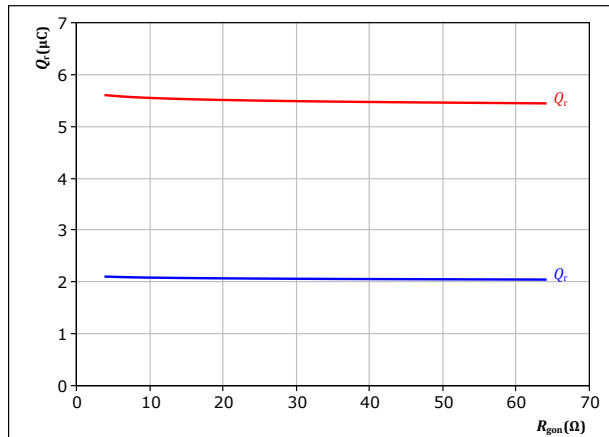

With an inductive load at

$V_{CE} = 600$ V
 $V_{GE} = \pm 15$ V
 $I_c = 35$ A

T_j : — 25 °C
— 150 °C

figure 19. FWD

Typical peak reverse recovery current as a function of collector current

$$I_{RM} = f(I_c)$$

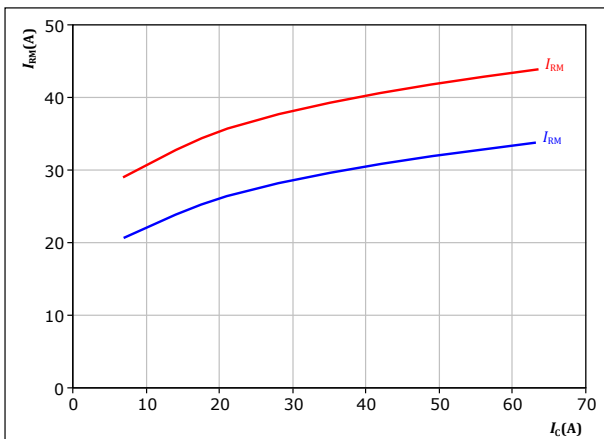

With an inductive load at

$V_{CE} = 600$ V
 $V_{GE} = \pm 15$ V
 $R_{gon} = 16$ Ω

T_j : — 25 °C
— 150 °C

figure 20. FWD

Typical peak reverse recovery current as a function of IGBT turn on gate resistor

$$I_{RM} = f(R_{gon})$$

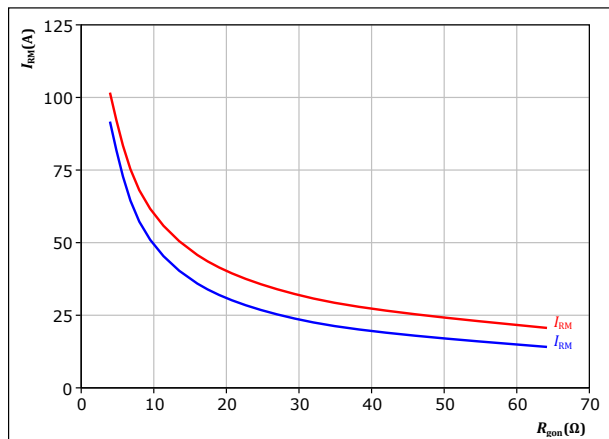

With an inductive load at

$V_{CE} = 600$ V
 $V_{GE} = \pm 15$ V
 $I_c = 35$ A

T_j : — 25 °C
— 150 °C



Inverter Switching Characteristics

figure 21. FWD

Typical rate of fall of forward and reverse recovery current as a function of collector current
 $di_f/dt, di_r/dt = f(I_c)$

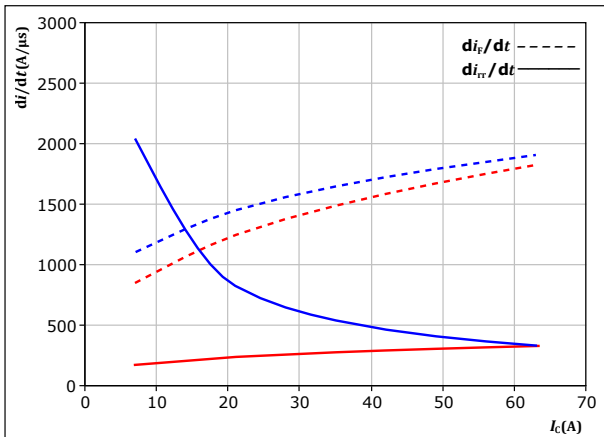

With an inductive load at

$V_{CE} = 600 \text{ V}$
 $V_{GE} = \pm 15 \text{ V}$
 $R_{gon} = 16 \ \Omega$

T_j : — 25 °C
 — 150 °C

figure 22. FWD

Typical rate of fall of forward and reverse recovery current as a function of turn on gate resistor
 $di_f/dt, di_r/dt = f(R_{gon})$

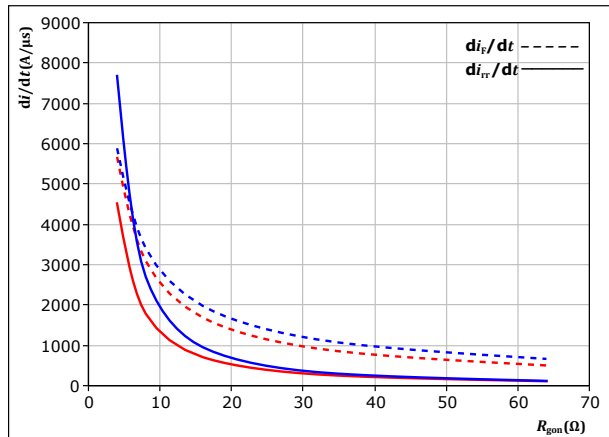

With an inductive load at

$V_{CE} = 600 \text{ V}$
 $V_{GE} = \pm 15 \text{ V}$
 $I_c = 35 \text{ A}$

T_j : — 25 °C
 — 150 °C

figure 23. IGBT

Reverse bias safe operating area

$I_c = f(V_{CE})$

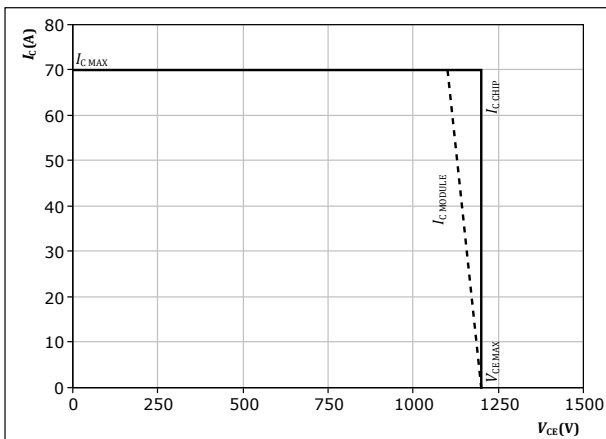

At $T_j = 150 \text{ °C}$
 $R_{gon} = 16 \ \Omega$
 $R_{goff} = 16 \ \Omega$



Inverter Switching Definitions

figure 24. IGBT
Turn-off Switching Waveforms & definition of t_{doff} , t_{Eoff} (t_{Eoff} = integrating time for E_{off})

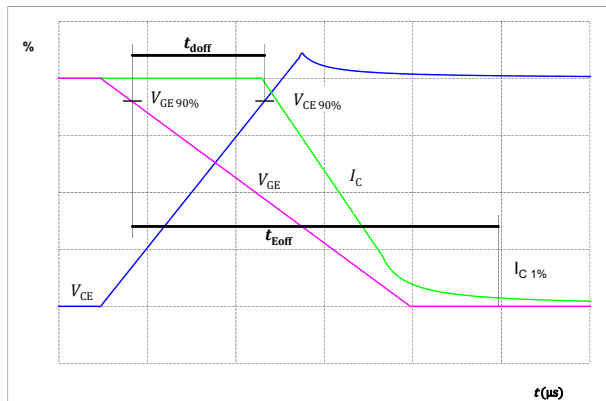

figure 25. IGBT
Turn-on Switching Waveforms & definition of t_{don} , t_{Eon} (t_{Eon} = integrating time for E_{on})



figure 26. IGBT
Turn-off Switching Waveforms & definition of t_f

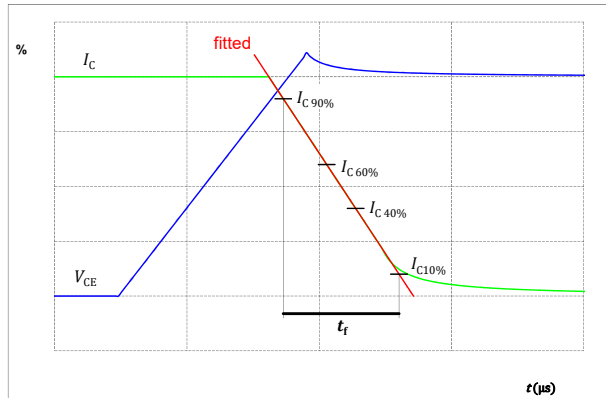
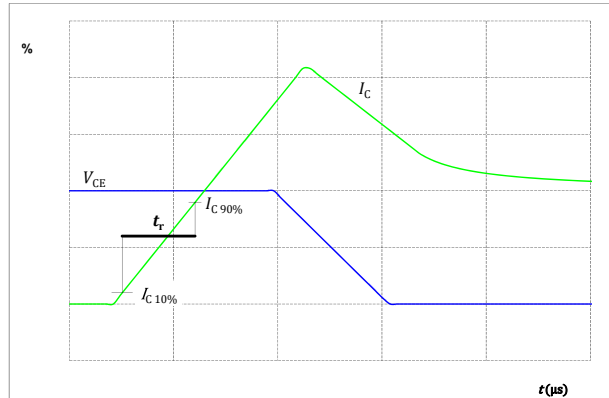

figure 27. IGBT
Turn-on Switching Waveforms & definition of t_r





Inverter Switching Definitions

figure 28. FWD

Turn-off Switching Waveforms & definition of t_{rr}

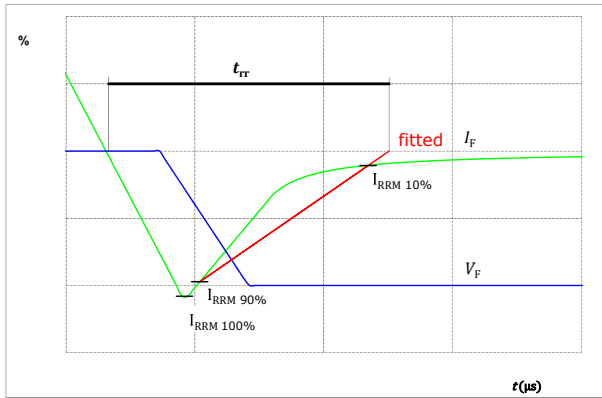
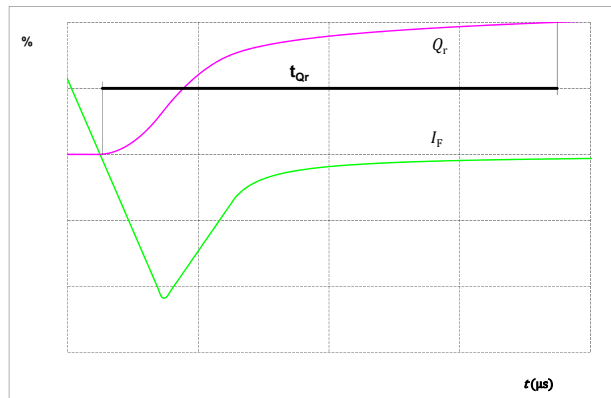



figure 29. FWD

Turn-on Switching Waveforms & definition of t_{Qr} (t_{Qr} = integrating time for Q_r)





Ordering Code	
Version	Ordering Code
With std lid (6.5mm height) + no thermal grease	V23990-K238-F40-/0A/
With thin lid (2.8mm height) + no thermal grease	V23990-K238-F40-/0B/
With std lid (6.5mm height) + thermal grease (0,8 W/mK, P12, silicone-based)	V23990-K238-F40-/1A/
With thin lid (2.8mm height) + thermal grease (0,8 W/mK, P12, silicone-based)	V23990-K238-F40-/1B/
With std lid (6.5mm height) + thermal grease (2,5 W/mK, TG20032, silicone-free)	V23990-K238-F40-/4A/
With thin lid (2.8mm height) + thermal grease (2,5 W/mK, TG20032, silicone-free)	V23990-K238-F40-/4B/
With std lid (6.5mm height) + thermal grease (2,5 W/mK, HPTP, silicone-based)	V23990-K238-F40-/5A/
With thin lid (2.8mm height) + thermal grease (2,5 W/mK, HPTP, silicone-based)	V23990-K238-F40-/5B/

Marking							
Text	VIN	Date code	Type&Ver	UL	Lot	Serial	
	VIN	WWYY	TTTTTTTV	UL	LLLLL	SSSS	
	Type&Ver	Lot number	Serial	Date code			
	TTTTTTTV	LLLLL	SSSS	WWYY			

Outline							
Pin table [mm]							
Pin	X	Y	Function	34	not assembled		
1	24,38	-21,8	+DC	35	0,03	9	U
2	24,38	-18,6	+DC	36	0,03	12,2	U
3	24,38	-15,4	+DC	37	0,03	15,4	U
4	24,38	-12,2	+DC	38	0,03	18,6	U
5	24,38	-9	+DC	39	0,03	21,8	U
6	not assembled			40	-8,5	-21,8	W
7	not assembled			41	not assembled		
8	24,38	12,2	+T	42	not assembled		
9	not assembled			43	not assembled		
10	not assembled			44	-12,22	-9	V
11	24,38	21,8	-T	45	-12,22	-5,8	V
12	not assembled			46	not assembled		
13	not assembled			47	-12,22	3,9	V
14	not assembled			48	-12,22	7,1	V
15	not assembled			49	-12,22	10,3	V
16	13,42	-21,8	G5	50	not assembled		
17	not assembled			51	not assembled		
18	not assembled			52	not assembled		
19	not assembled			53	-24,38	-21,8	G6
20	not assembled			54	-24,38	-18,6	E6
21	not assembled			55	-24,38	-15,4	-DC
22	8,38	2,6	E3	56	-24,38	-12,2	-DC
23	8,38	5,8	G3	57	-24,38	-9	-DC
24	not assembled			58	-24,38	-5,8	E4
25	not assembled			59	not assembled		
26	8,38	18,6	E1	60	-24,38	0,7	G4
27	8,38	21,8	G1	61	not assembled		
28	2,46	-21,8	E5	62	-24,38	7,1	-DC
29	2,46	-18,6	W	63	-24,38	15,4	-DC
30	2,46	-15,4	W	64	-24,38	18,6	E2
31	2,46	-12,2	W	65	-24,38	21,8	G2
32	2,46	-9	W				
33	not assembled						

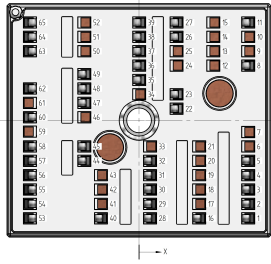

Pad positions refers to center point. For more informations on pad design please see package data



Vincotech

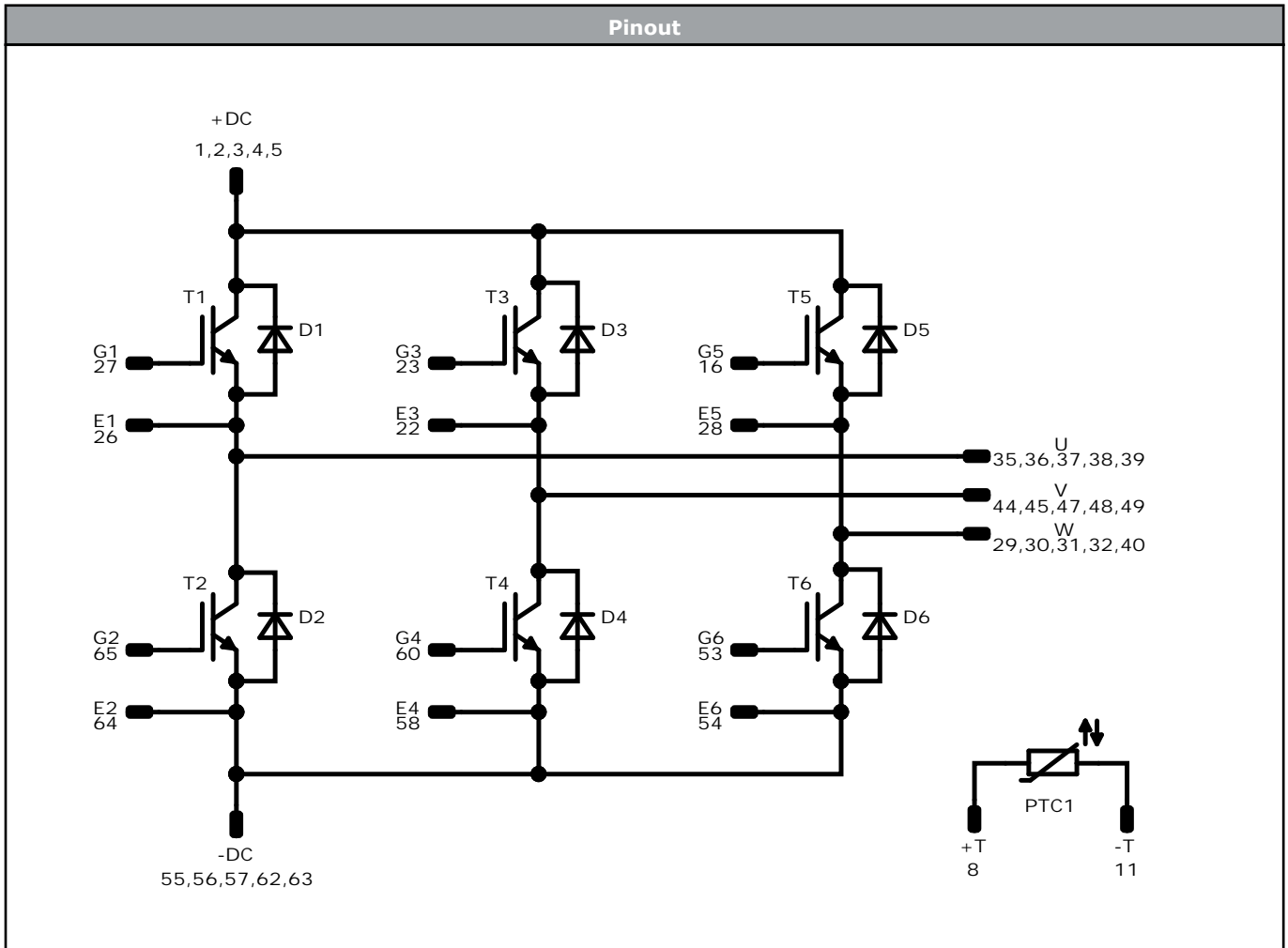

Identification					
ID	Component	Voltage	Current	Function	Comment
T2, T1, T4, T3, T6, T5	IGBT	1200 V	35 A	Inverter Switch	
D1, D2, D3, D4, D5, D6	FWD	1200 V	35 A	Inverter Diode	
PTC1	Thermistor			Thermistor	



Vincotech

Packaging instruction				
Standard packaging quantity (SPQ) 72	>SPQ	Standard	<SPQ	Sample

Handling instruction
Handling instructions for MiniSKiiP® 2 packages see vincotech.com website.

Package data
Package data for MiniSKiiP® 2 packages see vincotech.com website.

Vincotech thermistor reference
See Vincotech thermistor reference table at vincotech.com website.

UL recognition and file number
This device is certified according to UL 1557 standard, UL file number E192116. For more information see vincotech.com website. 

Document No.:	Date:	Modification:	Pages
V23990-K238-F40-D3-14	30 Apr. 2022	New Datasheet format, module is unchanged Introduce Rth values with HPTP	

DISCLAIMER

The information, specifications, procedures, methods and recommendations herein (together "information") are presented by Vincotech to reader in good faith, are believed to be accurate and reliable, but may well be incomplete and/or not applicable to all conditions or situations that may exist or occur. Vincotech reserves the right to make any changes without further notice to any products to improve reliability, function or design. No representation, guarantee or warranty is made to reader as to the accuracy, reliability or completeness of said information or that the application or use of any of the same will avoid hazards, accidents, losses, damages or injury of any kind to persons or property or that the same will not infringe third parties rights or give desired results. It is reader's sole responsibility to test and determine the suitability of the information and the product for reader's intended use.

LIFE SUPPORT POLICY

Vincotech products are not authorised for use as critical components in life support devices or systems without the express written approval of Vincotech.

As used herein:

1. Life support devices or systems are devices or systems which, (a) are intended for surgical implant into the body, or (b) support or sustain life, or (c) whose failure to perform when properly used in accordance with instructions for use provided in labelling can be reasonably expected to result in significant injury to the user.
2. A critical component is any component of a life support device or system whose failure to perform can be reasonably expected to cause the failure of the life support device or system, or to affect its safety or effectiveness.