

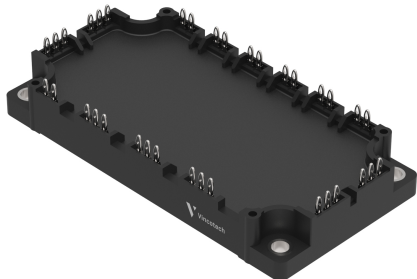

VINcoPACK E3	1200 V / 150 A
<p data-bbox="375 443 478 472">Features</p> <ul data-bbox="135 495 598 627" style="list-style-type: none">• IGBT Mitsubishi gen 7 technology with low VCesat and improved EMC behavior• New SoLid Cover Technology for higher reliability• Industry standard housing• Press-fit pin and pre-applied phase-change Thermal Interface Material available	<p data-bbox="1002 443 1292 472">VINco E3 17 mm housing</p> 
<p data-bbox="316 864 539 893">Target applications</p> <ul data-bbox="135 913 295 936" style="list-style-type: none">• Industrial Drives	<p data-bbox="1086 831 1209 860">Schematic</p> 
<p data-bbox="391 999 462 1028">Types</p> <ul data-bbox="135 1048 422 1070" style="list-style-type: none">• A0-VP126PA150M7-L998F70T	

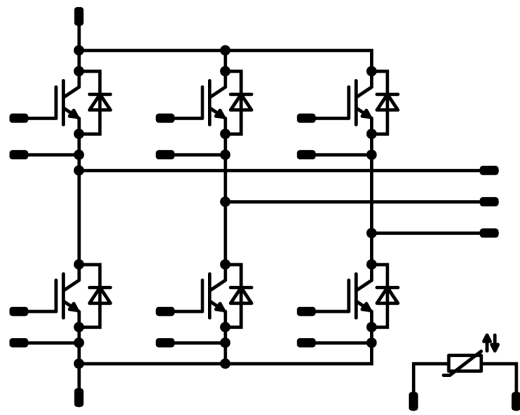

Vincotech

A0-VP126PA150M7-L998F70T
datasheet

Maximum Ratings

$T_j = 25\text{ °C}$, unless otherwise specified

Parameter	Symbol	Conditions	Value	Unit
Inverter Switch				
Collector-emitter voltage	V_{CES}		1200	V
Collector current (DC current)	I_C	$T_j = T_{jmax}$ $T_s = 80\text{ °C}$	144	A
Repetitive peak collector current	I_{CRM}	t_p limited by T_{jmax}	300	A
Total power dissipation	P_{tot}	$T_j = T_{jmax}$ $T_s = 80\text{ °C}$	272	W
Gate-emitter voltage	V_{GES}		± 20	V
Short circuit ratings	t_{SC}	$V_{GE} = 15\text{ V}$, $V_{CC} = 800\text{ V}$ $T_j = 150\text{ °C}$	9,5	μs
Maximum junction temperature	T_{jmax}		175	$^{\circ}\text{C}$

Inverter Diode

Peak repetitive reverse voltage	V_{RRM}		1200	V
Forward current (DC current)	I_F	$T_j = T_{jmax}$ $T_s = 80\text{ °C}$	117	A
Repetitive peak forward current	I_{FRM}	t_p limited by T_{jmax}	300	A
Total power dissipation	P_{tot}	$T_j = T_{jmax}$ $T_s = 80\text{ °C}$	204	W
Maximum junction temperature	T_{jmax}		175	$^{\circ}\text{C}$

Module Properties

Thermal Properties

Storage temperature	T_{stg}		-40...+125	$^{\circ}\text{C}$
Operation temperature under switching condition	T_{jop}		-40...+($T_{jmax} - 25$)	$^{\circ}\text{C}$

Isolation Properties

Isolation voltage	V_{isol}	DC Test Voltage* $t_p = 2\text{ s}$	6000	V
Isolation voltage	V'_{isol}	AC Voltage $t_p = 1\text{ min}$	2500	V
Creepage distance			>12,7	mm
Clearance			9	mm
Comparative Tracking Index	CTI		≥ 200	

*100 % tested in production



Vincotech

Characteristic Values

Parameter	Symbol	Conditions					Values			Unit
		V_{GE} [V] V_{GS} [V]	V_{CE} [V] V_{DS} [V] V_F [V]	I_C [A] I_D [A] I_F [A]	T_j [°C]	Min	Typ	Max		

Inverter Switch

Static

Gate-emitter threshold voltage	$V_{GE(th)}$			10	0,015	25	5,4	6	6,6	V
Collector-emitter saturation voltage	$V_{CE(sat)}$		15		150	25 125 150		1,58 1,8 1,86	1,85 ⁽¹⁾	V
Collector-emitter cut-off current	I_{CES}		0	1200		25			100	μA
Gate-emitter leakage current	I_{GES}		20	0		25			500	nA
Internal gate resistance	r_g							3		Ω
Input capacitance	C_{ies}							30000		pF
Output capacitance	C_{oes}		0	10		25		880		pF
Reverse transfer capacitance	C_{res}							320		pF
Gate charge	Q_g	$V_{CC} = 600$ V	15		150	25		1000		nC

Thermal

Thermal resistance junction to sink ⁽²⁾	$R_{th(j-s)}$	$\lambda_{paste} = 3,4$ W/mK (PSX)						0,35		K/W
--	---------------	---------------------------------------	--	--	--	--	--	------	--	-----

Dynamic

Turn-on delay time	$t_{d(on)}$					25 125 150		291,8 306,4 309,2		ns
Rise time	t_r					25 125 150		52,8 62,2 67		ns
Turn-off delay time	$t_{d(off)}$					25 125 150		239,2 271,8 282,4		ns
Fall time	t_f					25 125 150		63,21 86,11 93,9		ns
Turn-on energy (per pulse)	E_{on}	$Q_{tFWD} = 14,21$ μC $Q_{tFWD} = 22,33$ μC $Q_{tFWD} = 25,72$ μC				25 125 150		14,9 20,53 22,36		mWs
Turn-off energy (per pulse)	E_{off}					25 125 150		8,75 12,22 13,26		mWs



Vincotech

A0-VP126PA150M7-L998F70T
datasheet

Characteristic Values

Parameter	Symbol	Conditions					Values			Unit
		V_{GE} [V] V_{GS} [V]	V_{CE} [V] V_{DS} [V] V_F [V]	I_C [A] I_D [A] I_F [A]	T_j [°C]	Min	Typ	Max		
Inverter Diode										
Static										
Forward voltage	V_F			150	25 125 150		1,79 1,9 1,9	2,1 ⁽¹⁾		V
Reverse leakage current	I_R	$V_r = 1200$ V			25			40		μA
Thermal										
Thermal resistance junction to sink ⁽²⁾	$R_{th(j-s)}$	$\lambda_{paste} = 3,4$ W/mK (PSX)					0,46			K/W
Dynamic										
Peak recovery current	I_{RRM}				25 125 150		88,34 90,48 91,78			A
Reverse recovery time	t_{rr}				25 125 150		344,7 507 562,67			ns
Recovered charge	Q_r	$di/dt=2255$ A/μs $di/dt=1996$ A/μs $di/dt=1932$ A/μs	±15	600	150	25 125 150	14,21 22,33 25,72			μC
Reverse recovered energy	E_{rec}				25 125 150		4,94 8,13 9,46			mWs
Peak rate of fall of recovery current	$(di_r/dt)_{max}$				25 125 150		452,88 328,17 325,43			A/μs



Vincotech

Characteristic Values

Parameter	Symbol	Conditions					Values			Unit
		V_{GS} [V]	V_{GE} [V]	V_{DS} [V]	V_{CE} [V]	T_j [°C]	Min	Typ	Max	

Thermistor

Static

Rated resistance	R					25		5		kΩ
Deviation of R_{100}	$A_{R/R}$	$R_{100} = 493 \Omega$				100	-5		5	%
Power dissipation	P							245		mW
Power dissipation constant	d					25		1,4		mW/K
B-value	$B_{(25/50)}$	Tol. $\pm 2 \%$						3375		K
B-value	$B_{(25/100)}$	Tol. $\pm 2 \%$						3437		K
Vincotech Thermistor Reference									K	

⁽¹⁾ Value at chip level

⁽²⁾ Only valid with pre-applied Vincotech thermal interface material.



Inverter Switch Characteristics

figure 1. IGBT

Typical output characteristics

$$I_C = f(V_{CE})$$

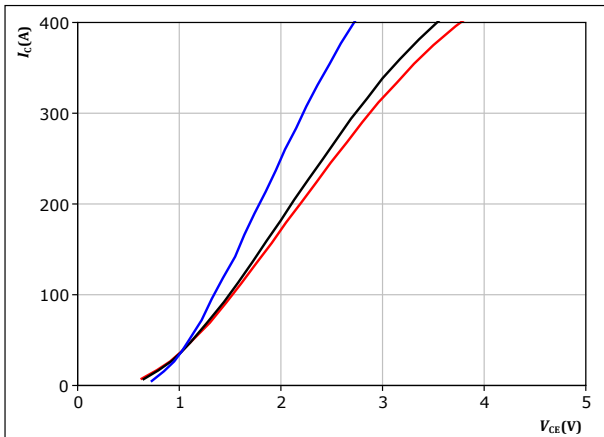

$t_p = 250 \mu s$
 $V_{GE} = 15 V$

$T_j:$ — 25 °C
— 125 °C
— 150 °C

figure 2. IGBT

Typical output characteristics

$$I_C = f(V_{CE})$$

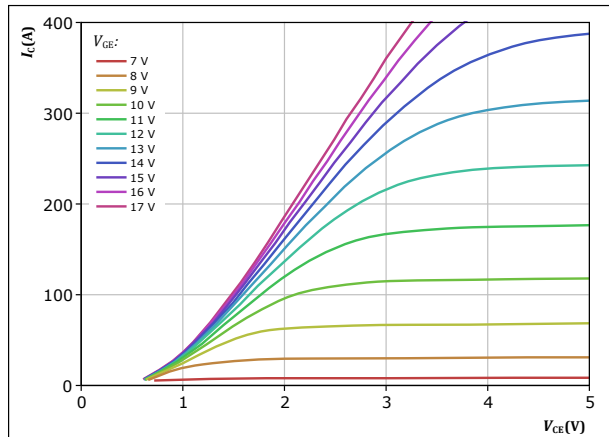

$t_p = 250 \mu s$
 $T_j = 150 \text{ °C}$
 V_{GE} from 7 V to 17 V in steps of 1 V

figure 3. IGBT

Typical transfer characteristics

$$I_C = f(V_{GE})$$

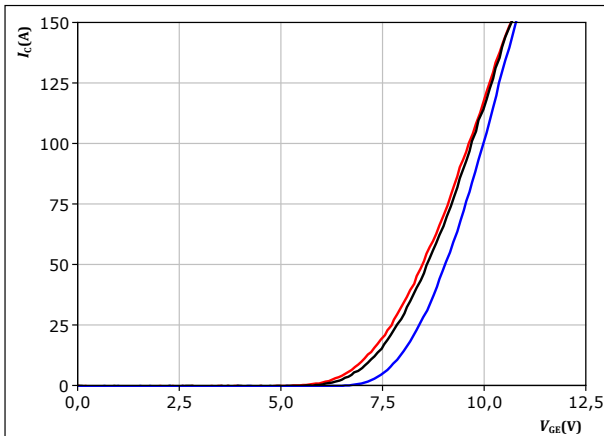

$t_p = 250 \mu s$
 $V_{CE} = 10 V$

$T_j:$ — 25 °C
— 125 °C
— 150 °C

figure 4. IGBT

Transient thermal impedance as a function of pulse width

$$Z_{th(j-s)} = f(t_p)$$

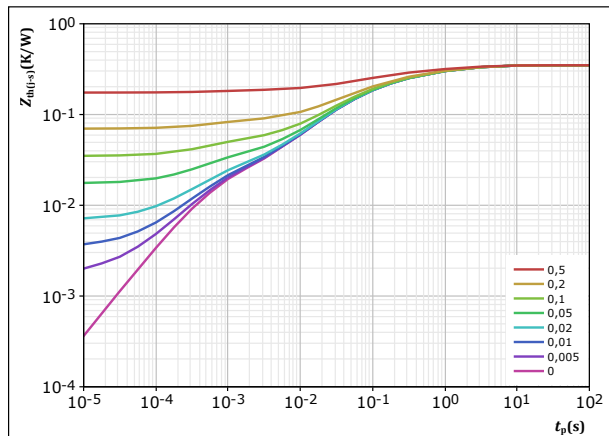

$D = t_p / T$
 $R_{th(j-s)} = 0,349 \text{ K/W}$

IGBT thermal model values

R (K/W)	τ (s)
4,14E-02	3,34E+00
8,71E-02	6,14E-01
1,12E-01	1,17E-01
8,40E-02	2,74E-02
8,14E-03	5,18E-03
1,66E-02	5,36E-04



Vincotech

Inverter Switch Characteristics

figure 5. IGBT

Safe operating area

$$I_C = f(V_{CE})$$

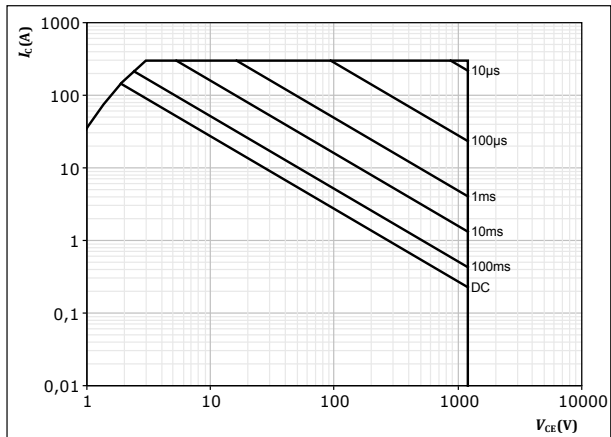

$D =$ single pulse

$T_s = 80 \text{ } ^\circ\text{C}$

$V_{GE} = 15 \text{ V}$

$T_j = T_{jmax}$



Inverter Diode Characteristics

figure 6. FWD

Typical forward characteristics

$$I_F = f(V_F)$$

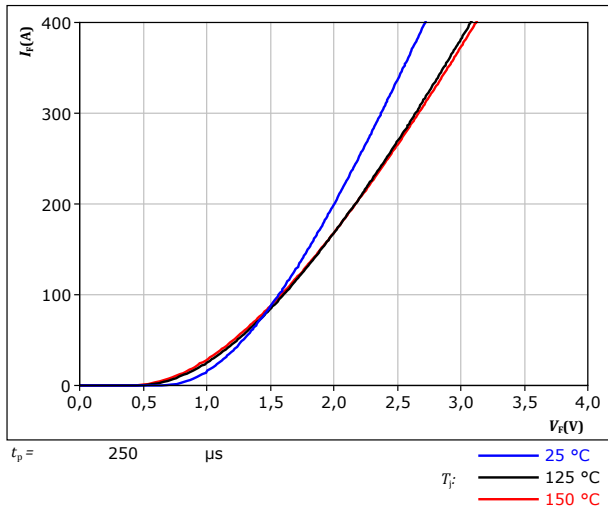
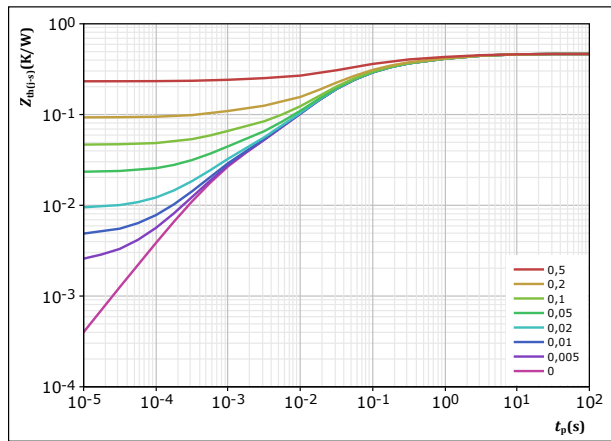

figure 7. FWD

Transient thermal impedance as a function of pulse width

$$Z_{th(j-s)} = f(t_p)$$



$D = t_p / T$
 $R_{th(j-s)} = 0,465 \text{ K/W}$
 FWD thermal model values

R (K/W)	τ (s)
3,22E-02	4,93E+00
6,91E-02	1,02E+00
1,24E-01	1,62E-01
1,47E-01	4,06E-02
6,91E-02	1,26E-02
2,40E-02	7,94E-04



Thermistor Characteristics

figure 8. Thermistor

Typical NTC characteristic as function of temperature

$$R_T = f(T)$$

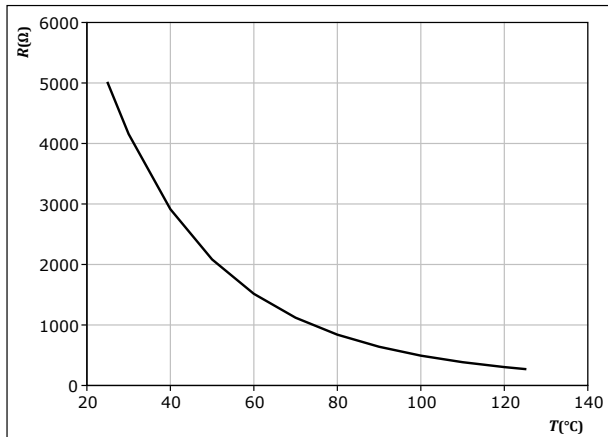



Inverter Switching Characteristics

figure 9. IGBT

Typical switching energy losses as a function of collector current
 $E = f(I_c)$

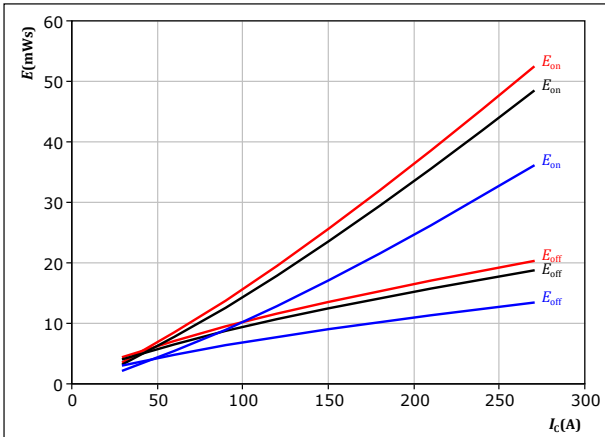

With an inductive load at

$V_{CE} = 600$ V	$T_j: 25$ °C
$V_{GE} = \pm 15$ V	$T_j: 125$ °C
$R_{g(on)} = 1$ Ω	$T_j: 150$ °C
$R_{g(off)} = 1$ Ω	

figure 10. IGBT

Typical switching energy losses as a function of gate resistor
 $E = f(R_g)$

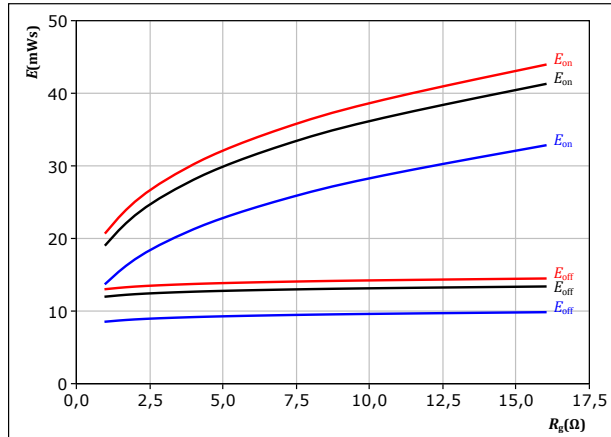

With an inductive load at

$V_{CE} = 600$ V	$T_j: 25$ °C
$V_{GE} = \pm 15$ V	$T_j: 125$ °C
$I_c = 150$ A	$T_j: 150$ °C

figure 11. FWD

Typical reverse recovered energy loss as a function of collector current
 $E_{rec} = f(I_c)$

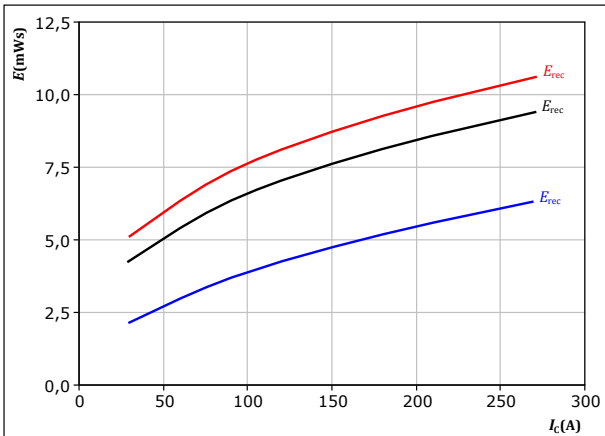

With an inductive load at

$V_{CE} = 600$ V	$T_j: 25$ °C
$V_{GE} = \pm 15$ V	$T_j: 125$ °C
$R_{g(on)} = 1$ Ω	$T_j: 150$ °C

figure 12. FWD

Typical reverse recovered energy loss as a function of gate resistor
 $E_{rec} = f(R_g)$

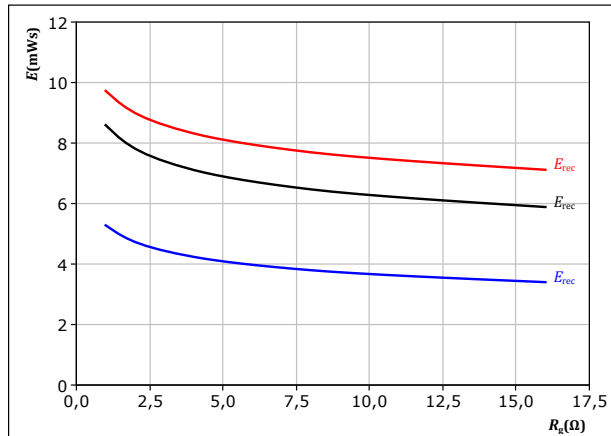

With an inductive load at

$V_{CE} = 600$ V	$T_j: 25$ °C
$V_{GE} = \pm 15$ V	$T_j: 125$ °C
$I_c = 150$ A	$T_j: 150$ °C



Inverter Switching Characteristics

figure 13. IGBT

Typical switching times as a function of collector current
 $t = f(I_c)$

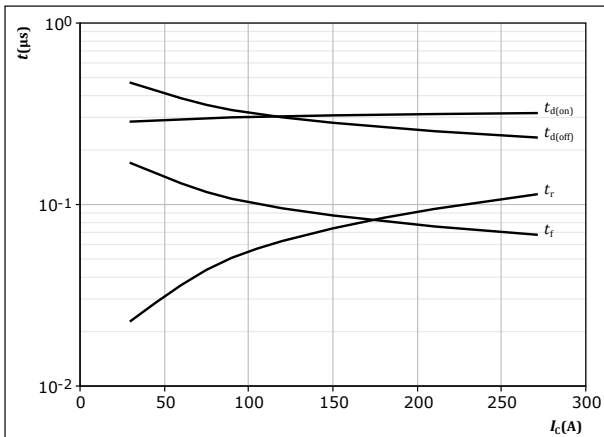

With an inductive load at
 $T_j = 150 \text{ }^\circ\text{C}$
 $V_{CE} = 600 \text{ V}$
 $V_{GE} = \pm 15 \text{ V}$
 $R_{g(on)} = 1 \text{ } \Omega$
 $R_{g(off)} = 1 \text{ } \Omega$

figure 14. IGBT

Typical switching times as a function of gate resistor
 $t = f(R_g)$

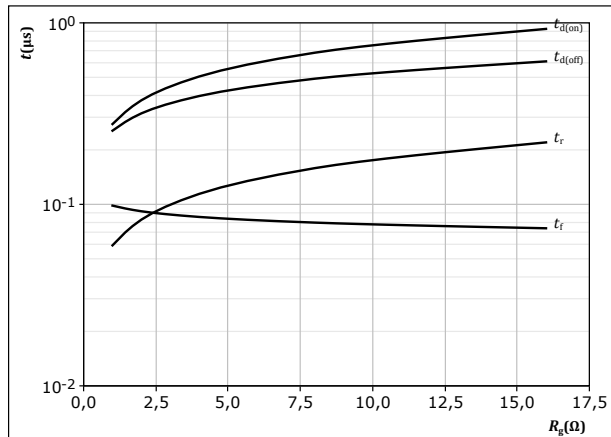

With an inductive load at
 $T_j = 150 \text{ }^\circ\text{C}$
 $V_{CE} = 600 \text{ V}$
 $V_{GE} = \pm 15 \text{ V}$
 $I_c = 150 \text{ A}$

figure 15. FWD

Typical reverse recovery time as a function of collector current
 $t_{rr} = f(I_c)$

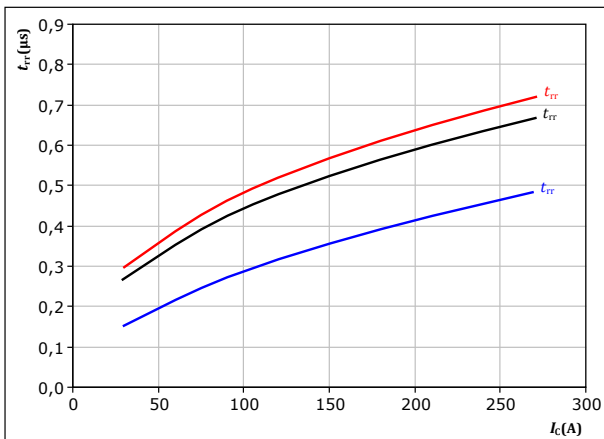

With an inductive load at
 $V_{CE} = 600 \text{ V}$
 $V_{GE} = \pm 15 \text{ V}$
 $R_{g(on)} = 1 \text{ } \Omega$
 $T_j:$ — 25 °C
 — 125 °C
 — 150 °C

figure 16. FWD

Typical reverse recovery time as a function of IGBT turn off gate resistor
 $t_{rr} = f(R_{g(off)})$

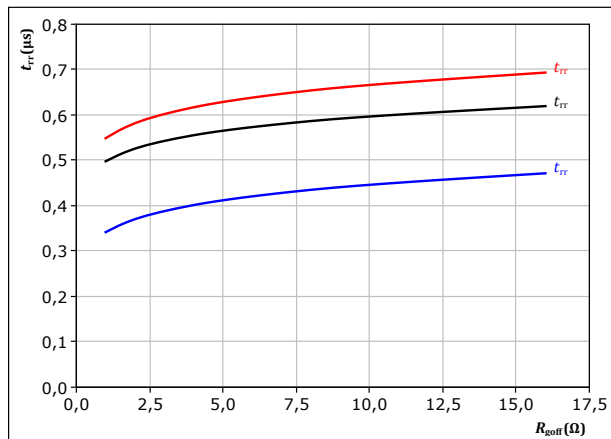

With an inductive load at
 $V_{CE} = 600 \text{ V}$
 $V_{GE} = \pm 15 \text{ V}$
 $I_c = 150 \text{ A}$
 $T_j:$ — 25 °C
 — 125 °C
 — 150 °C



Inverter Switching Characteristics

figure 17. FWD

Typical recovered charge as a function of collector current

$$Q_r = f(I_c)$$

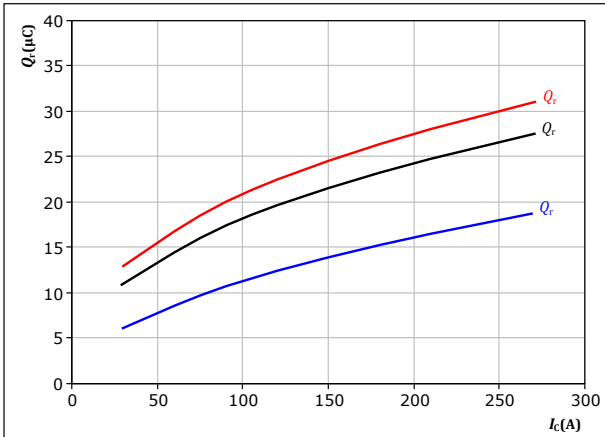

With an inductive load at

$V_{CE} =$	600	V	$T_j:$	25 °C
$V_{GE} =$	±15	V		125 °C
$R_{goff} =$	1	Ω		150 °C

figure 19. FWD

Typical peak reverse recovery current as a function of collector current

$$I_{RM} = f(I_c)$$

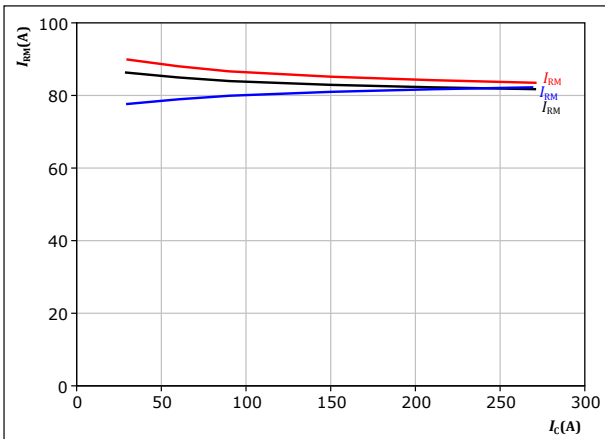

With an inductive load at

$V_{CE} =$	600	V	$T_j:$	25 °C
$V_{GE} =$	±15	V		125 °C
$R_{goff} =$	1	Ω		150 °C

figure 18. FWD

Typical recovered charge as a function of turn off gate resistor

$$Q_r = f(R_{goff})$$

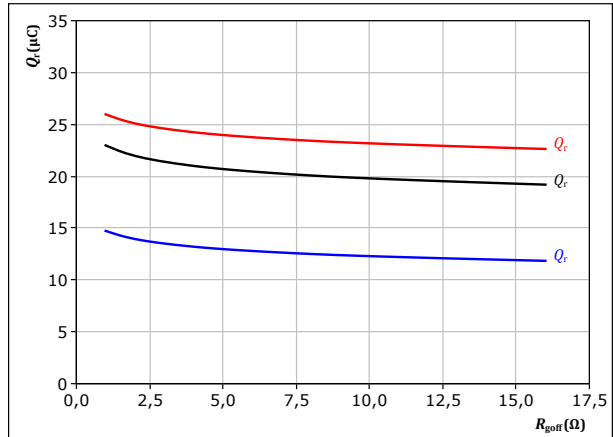

With an inductive load at

$V_{CE} =$	600	V	$T_j:$	25 °C
$V_{GE} =$	±15	V		125 °C
$I_c =$	150	A		150 °C

figure 20. FWD

Typical peak reverse recovery current as a function of turn off gate resistor

$$I_{RM} = f(R_{goff})$$

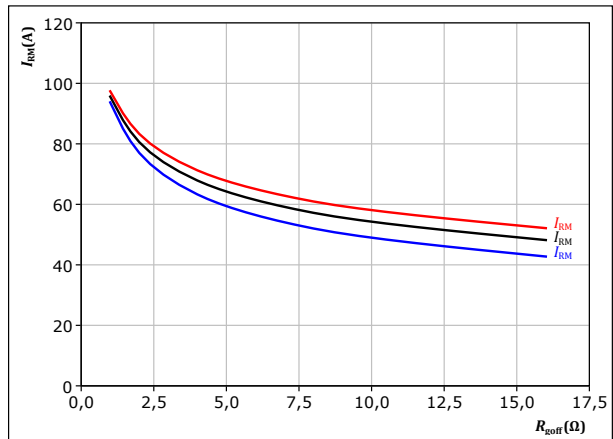

With an inductive load at

$V_{CE} =$	600	V	$T_j:$	25 °C
$V_{GE} =$	±15	V		125 °C
$I_c =$	150	A		150 °C



Inverter Switching Characteristics

figure 21. FWD

Typical rate of fall of forward and reverse recovery current as a function of collector current
 $di_f/dt, di_{rr}/dt = f(I_c)$

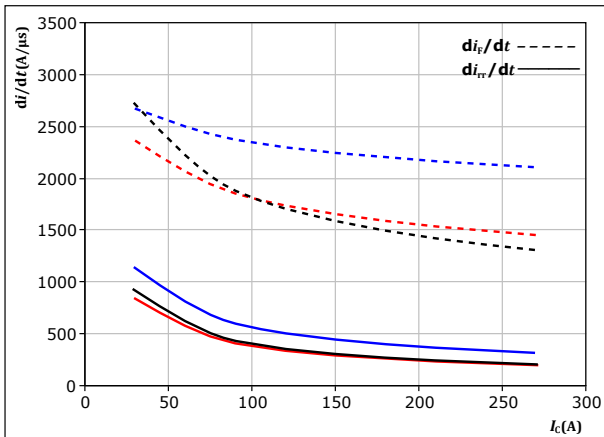

With an inductive load at

$V_{CE} = 600 \text{ V}$	$T_j = 25 \text{ }^\circ\text{C}$
$V_{GE} = \pm 15 \text{ V}$	$T_j = 125 \text{ }^\circ\text{C}$
$R_{goff} = 1 \text{ } \Omega$	$T_j = 150 \text{ }^\circ\text{C}$

figure 22. FWD

Typical rate of fall of forward and reverse recovery current as a function of turn off gate resistor
 $di_f/dt, di_{rr}/dt = f(R_{goff})$

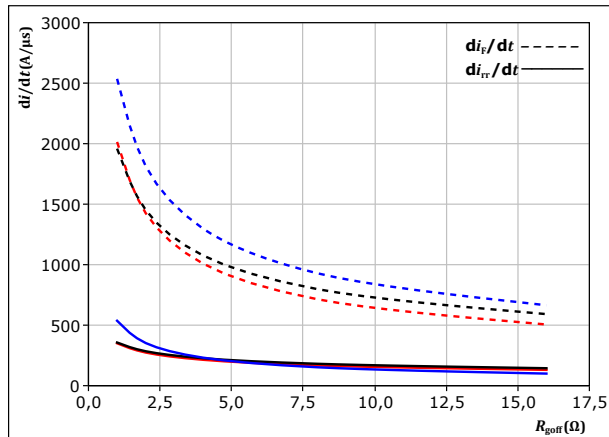

With an inductive load at

$V_{CE} = 600 \text{ V}$	$T_j = 25 \text{ }^\circ\text{C}$
$V_{GE} = \pm 15 \text{ V}$	$T_j = 125 \text{ }^\circ\text{C}$
$I_c = 150 \text{ A}$	$T_j = 150 \text{ }^\circ\text{C}$

figure 23. IGBT

Reverse bias safe operating area
 $I_c = f(V_{CE})$

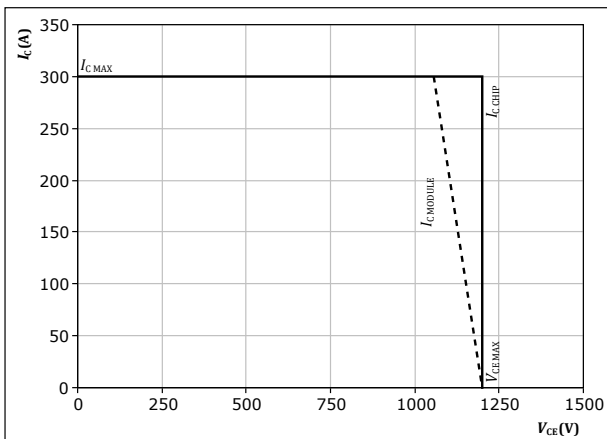

At $T_j = 150 \text{ }^\circ\text{C}$
 $R_{goff} = 1 \text{ } \Omega$
 $R_{goff} = 1 \text{ } \Omega$



Inverter Switching Definitions

figure 24. IGBT

Turn-off Switching Waveforms & definition of t_{doff} , t_{Eoff} (t_{Eoff} = integrating time for E_{off})

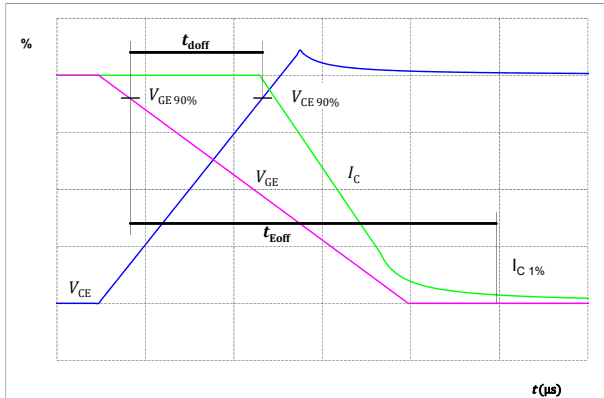

figure 25. IGBT

Turn-on Switching Waveforms & definition of t_{don} , t_{Eon} (t_{Eon} = integrating time for E_{on})

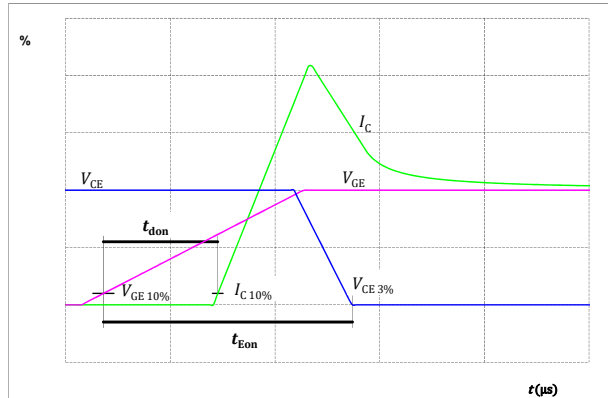

figure 26. IGBT

Turn-off Switching Waveforms & definition of t_f

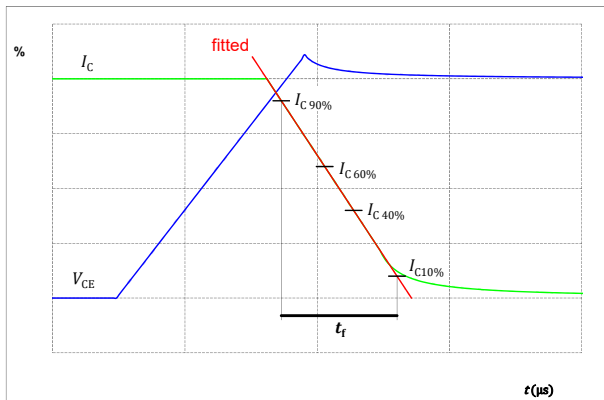
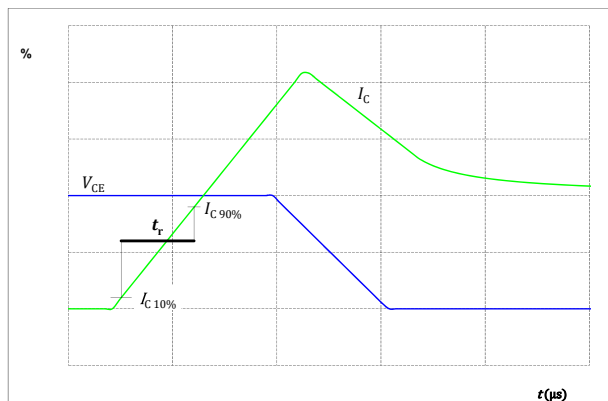

figure 27. IGBT

Turn-on Switching Waveforms & definition of t_r





Inverter Switching Definitions

figure 28. FWD

Turn-off Switching Waveforms & definition of t_{rr}

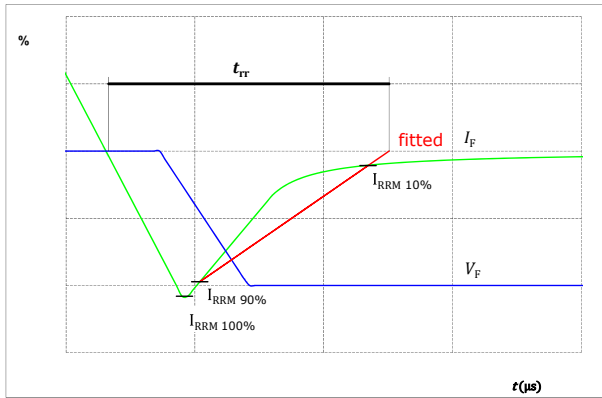
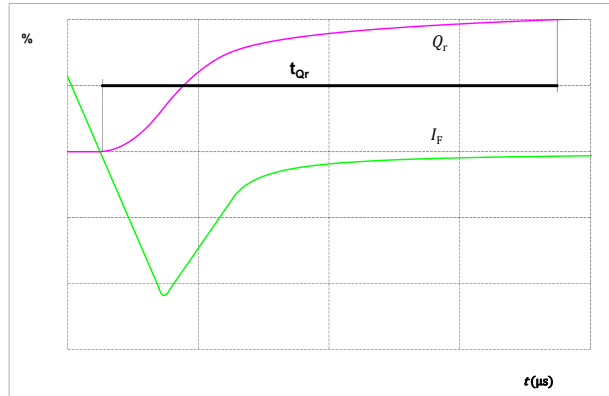

figure 29. FWD

Turn-on Switching Waveforms & definition of t_{Qr} (t_{Qr} = integrating time for Q_r)





A0-VP126PA150M7-L998F70T

datasheet

Vincotech

Ordering Code	
Version	Ordering Code
Without thermal paste	A0-VP126PA150M7-L998F70T
With thermal paste (3,4 W/mK, PSX-P7)	A0-VP126PA150M7-L998F70T-/3/

Marking						
 NN-NNNNNNNNNN-TTTTTTVV VIN WWYY LLLL SSSS	Text	Name NN-NNNNNNNNNNNNNNNN- TTTTTVV	VIN VIN	Date code WWYY	Lot LLLLL	Serial SSSS
	Datamatrix	Type&Ver TTTTTVV	Lot number LLLLL	Serial SSSS	Date code WWYY	

Outline			
Pin table [mm]			
Pin	X	Y	Function
1	19,05	0	G12
2	22,86	0	S12
3	34,29	0	G11
4	38,1	0	S11
5	49,53	0	G14
6	53,34	0	S14
7	64,77	0	G13
8	68,58	0	S13
9	80,01	0	G16
10	83,82	0	S16
11	95,25	0	G15
12	99,06	0	S15
13	118,11	15,865	DC-123
14	118,11	19,675	DC-123
15	118,11	23,485	DC-123
16	118,11	34,915	DC+123
17	118,11	38,725	DC+123
18	118,11	42,535	DC+123
19	100,965	58,4	Therm1
20	97,155	58,4	Therm2
21	81,915	58,4	Ph3
22	78,105	58,4	Ph3
23	74,295	58,4	Ph3
24	59,055	58,4	Ph2
25	55,245	58,4	Ph2
26	51,435	58,4	Ph2
27	36,195	58,4	Ph1
28	32,385	58,4	Ph1
29	28,575	58,4	Ph1
30	0	42,535	DC+123
31	0	38,725	DC+123
32	0	34,915	DC+123
33	0	23,485	DC-123
34	0	19,675	DC-123
35	0	15,865	DC-123

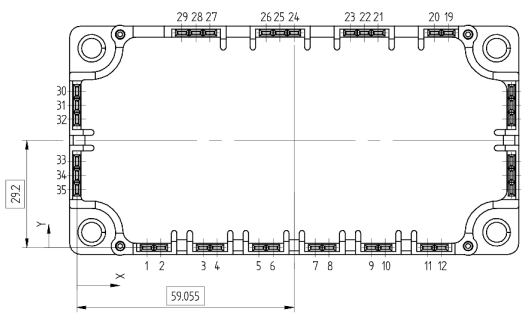



Vincotech

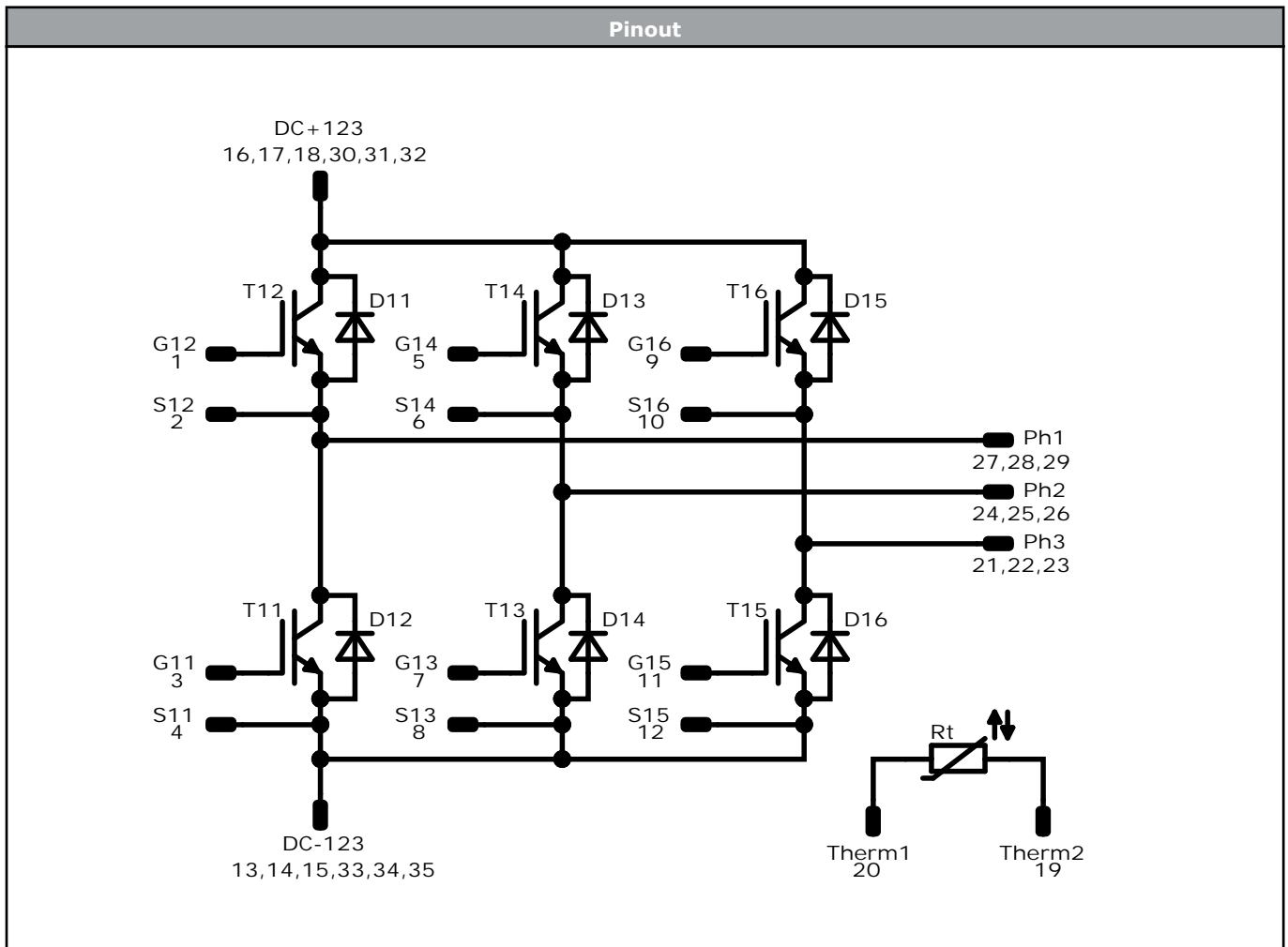

Identification					
ID	Component	Voltage	Current	Function	Comment
T11, T12, T13, T14, T15, T16	IGBT	1200 V	150 A	Inverter Switch	
D11, D12, D13, D14, D15, D16	FWD	1200 V	150 A	Inverter Diode	
Rt	Thermistor			Thermistor	



Vincotech

Packaging instruction				
Standard packaging quantity (SPQ) 24	>SPQ	Standard	<SPQ	Sample

Handling instruction
Handling instructions for VINco E3 packages see vincotech.com website.

Package data
Package data for VINco E3 packages see vincotech.com website.

Vincotech thermistor reference
See Vincotech thermistor reference table at vincotech.com website.

UL recognition and file number
This device is certified according to UL 1557 standard, UL file number E192116. For more information see vincotech.com website. 

Document No.:	Date:	Modification:	Pages
A0-VP126PA150M7-L998F70T-D3-14	26 Sep. 2021	All static and dynamic characteristics are updated Separated datasheet for press-fit version New datasheet format, module is unchanged	

DISCLAIMER

The information, specifications, procedures, methods and recommendations herein (together "information") are presented by Vincotech to reader in good faith, are believed to be accurate and reliable, but may well be incomplete and/or not applicable to all conditions or situations that may exist or occur. Vincotech reserves the right to make any changes without further notice to any products to improve reliability, function or design. No representation, guarantee or warranty is made to reader as to the accuracy, reliability or completeness of said information or that the application or use of any of the same will avoid hazards, accidents, losses, damages or injury of any kind to persons or property or that the same will not infringe third parties rights or give desired results. It is reader's sole responsibility to test and determine the suitability of the information and the product for reader's intended use.

LIFE SUPPORT POLICY

Vincotech products are not authorised for use as critical components in life support devices or systems without the express written approval of Vincotech.

As used herein:

1. Life support devices or systems are devices or systems which, (a) are intended for surgical implant into the body, or (b) support or sustain life, or (c) whose failure to perform when properly used in accordance with instructions for use provided in labelling can be reasonably expected to result in significant injury to the user.
2. A critical component is any component of a life support device or system whose failure to perform can be reasonably expected to cause the failure of the life support device or system, or to affect its safety or effectiveness.