



**MiniSKiiP® PIM 3**

**1200 V / 100 A**

**Topology features**

- Converter+Brake+Inverter
- Kelvin Emitter for improved switching performance
- Temperature sensor

**Component features**

- Easy paralleling
- Low turn-off losses
- Low collector emitter saturation voltage
- Positive temperature coefficient
- Short tail current
- Switching optimized for EMC

**Housing features**

- Base isolation: Al<sub>2</sub>O<sub>3</sub>
- Easy assembly in one mounting step
- Flexible PCB design w/o pin holes
- Rugged solderless spring contacts

**Extra features**

- Equivalent: SKiiP 38NAB12T4V1

**Target applications**

- Industrial Drives

**Types**

- 80-M312PMA100M7-K420A70

**MiniSKiiP® 3 16 mm housing**

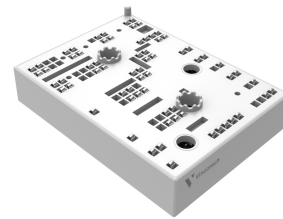

**Schematic**

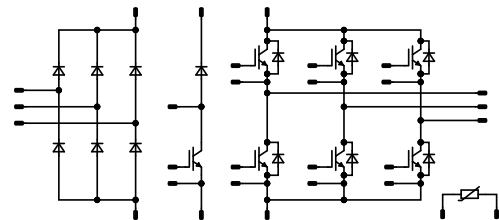



Vincotech

**80-M312PMA100M7-K420A70**  
datasheet

## Maximum Ratings

$T_j = 25\text{ °C}$ , unless otherwise specified

Parameter	Symbol	Conditions	Value	Unit
<b>Inverter Switch</b>				
Collector-emitter voltage	$V_{CES}$		1200	V
Collector current (DC current)	$I_C$	$T_j = T_{jmax}$ $T_s = 80\text{ °C}$	114	A
Repetitive peak collector current	$I_{CRM}$	$t_p$ limited by $T_{jmax}$	200	A
Total power dissipation	$P_{tot}$	$T_j = T_{jmax}$ $T_s = 80\text{ °C}$	240	W
Gate-emitter voltage	$V_{GES}$		$\pm 20$	V
Short circuit ratings	$t_{SC}$	$V_{GE} = 15\text{ V}$ , $V_{CC} = 800\text{ V}$ $T_j = 150\text{ °C}$	9,5	$\mu\text{s}$
Maximum junction temperature	$T_{jmax}$		175	$^{\circ}\text{C}$

<b>Inverter Diode</b>				
Peak repetitive reverse voltage	$V_{RRM}$		1200	V
Forward current (DC current)	$I_F$	$T_j = T_{jmax}$ $T_s = 80\text{ °C}$	81	A
Repetitive peak forward current	$I_{FRM}$	$t_p$ limited by $T_{jmax}$	200	A
Total power dissipation	$P_{tot}$	$T_j = T_{jmax}$ $T_s = 80\text{ °C}$	149	W
Maximum junction temperature	$T_{jmax}$		175	$^{\circ}\text{C}$

<b>Brake Switch</b>				
Collector-emitter voltage	$V_{CES}$		1200	V
Collector current (DC current)	$I_C$	$T_j = T_{jmax}$ $T_s = 80\text{ °C}$	114	A
Repetitive peak collector current	$I_{CRM}$	$t_p$ limited by $T_{jmax}$	200	A
Total power dissipation	$P_{tot}$	$T_j = T_{jmax}$ $T_s = 80\text{ °C}$	240	W
Gate-emitter voltage	$V_{GES}$		$\pm 20$	V
Short circuit ratings	$t_{SC}$	$V_{GE} = 15\text{ V}$ , $V_{CC} = 800\text{ V}$ $T_j = 150\text{ °C}$	9,5	$\mu\text{s}$
Maximum junction temperature	$T_{jmax}$		175	$^{\circ}\text{C}$



## Maximum Ratings

$T_j = 25\text{ °C}$ , unless otherwise specified

Parameter	Symbol	Conditions	Value	Unit
<b>Brake Diode</b>				
Peak repetitive reverse voltage	$V_{RRM}$		1200	V
Forward current (DC current)	$I_F$	$T_j = T_{jmax}$ $T_s = 80\text{ °C}$	81	A
Repetitive peak forward current	$I_{FRM}$	$t_p$ limited by $T_{jmax}$	200	A
Total power dissipation	$P_{tot}$	$T_j = T_{jmax}$ $T_s = 80\text{ °C}$	149	W
Maximum junction temperature	$T_{jmax}$		175	°C

## Rectifier Diode

Peak repetitive reverse voltage	$V_{RRM}$		1600	V
Forward current (DC current)	$I_F$	$T_j = T_{jmax}$ $T_s = 80\text{ °C}$	104	A
Surge (non-repetitive) forward current	$I_{FSM}$	Single Half Sine Wave, $t_p = 10\text{ ms}$ $T_j = 150\text{ °C}$	890	A
Surge current capability	$I^2t$		3960	A <sup>2</sup> s
Total power dissipation	$P_{tot}$	$T_j = T_{jmax}$ $T_s = 80\text{ °C}$	119	W
Maximum junction temperature	$T_{jmax}$		150	°C

## Module Properties

### Thermal Properties

Storage temperature	$T_{stg}$		-40...+125	°C
Operation temperature under switching condition	$T_{jop}$		-40...+( $T_{jmax} - 25$ )	°C

### Isolation Properties

Isolation voltage	$V_{isol}$	DC Test Voltage* $t_p = 2\text{ s}$	5500	V
Isolation voltage	$V_{isol}$	AC Voltage $t_p = 1\text{ min}$	2500	V
Creepage distance		With std lid For more informations see handling instructions	6,3	mm
Clearance		With std lid For more informations see handling instructions	6,3	mm
Comparative Tracking Index	CTI		≥ 600	

\*100 % tested in production



Vincotech

### Characteristic Values

Parameter	Symbol	Conditions					Values			Unit
		$V_{GS}$ [V]	$V_{GE}$ [V]	$V_{DS}$ [V]	$V_F$ [V]	$I_C$ [A] $I_D$ [A] $I_F$ [A]	$T_j$ [°C]	Min	Typ	

#### Inverter Switch

##### Static

Gate-emitter threshold voltage	$V_{GE(th)}$			10	0,01	25	5,4	6	6,6	V
Collector-emitter saturation voltage	$V_{CE(sat)}$		15		100	25 125 150		1,61 1,82 1,91	1,85 <sup>(1)</sup>	V
Collector-emitter cut-off current	$I_{CES}$		0	1200		25			100	μA
Gate-emitter leakage current	$I_{GES}$		20	0		25			200	nA
Internal gate resistance	$r_g$							None		Ω
Input capacitance	$C_{ies}$							21000		pF
Output capacitance	$C_{oes}$		0	10		25		700		pF
Reverse transfer capacitance	$C_{res}$							280		pF
Gate charge	$Q_g$	$V_{CC} = 600$ V	0/15		100	25		700		nC

##### Thermal

Thermal resistance junction to sink <sup>(2)</sup>	$R_{th(j-s)}$	$\lambda_{paste} = 2,5$ W/mK (HPTP)						0,4		K/W
--	---------------	--	--	--	--	--	--	-----	--	-----

##### Dynamic

Turn-on delay time	$t_{d(on)}$	$R_{gon} = 2$ Ω $R_{goff} = 2$ Ω	±15	600	100	25		118,2		ns
						125		118,2		
						150		117,6		
Rise time	$t_r$					25		10,2		ns
						125		12,4		
						150		13,4		
Turn-off delay time	$t_{d(off)}$					25		173,6		ns
						125		200,4		
						150		205,6		
Fall time	$t_f$					25		82,85		ns
						125		96,38		
						150		106,77		
Turn-on energy (per pulse)	$E_{on}$	$Q_{tFWD} = 11,6$ μC $Q_{tFWD} = 17,27$ μC $Q_{tFWD} = 19,18$ μC				25		3,26		mWs
						125		4,87		
						150		5,37		
Turn-off energy (per pulse)	$E_{off}$					25		6,6		mWs
						125		8,77		
						150		9,49		



Vincotech

**80-M312PMA100M7-K420A70**  
datasheet

### Characteristic Values

Parameter	Symbol	Conditions					Values			Unit
		$V_{GE}$ [V] $V_{GS}$ [V]	$V_{CE}$ [V] $V_{DS}$ [V] $V_F$ [V]	$I_C$ [A] $I_D$ [A] $I_F$ [A]	$T_j$ [°C]	Min	Typ	Max		
<b>Inverter Diode</b>										
<b>Static</b>										
Forward voltage	$V_F$				100	25 125 150		1,82 1,96 1,97	2,1 <sup>(1)</sup>	V
Reverse leakage current	$I_R$	$V_r = 1200$ V				25			40	μA
<b>Thermal</b>										
Thermal resistance junction to sink <sup>(2)</sup>	$R_{th(j-s)}$	$\lambda_{paste} = 2,5$ W/mK (HPTP)						0,64		K/W
<b>Dynamic</b>										
Peak recovery current	$I_{RM}$	$di/dt=9387$ A/μs $di/dt=7872$ A/μs $di/dt=8350$ A/μs	±15	600	100	25 125 150		178,25 165,9 164,61		A
Reverse recovery time	$t_{rr}$					25 125 150		149,24 311,54 339,17		ns
Recovered charge	$Q_r$					25 125 150		11,6 17,27 19,18		μC
Reverse recovered energy	$E_{rec}$					25 125 150		5,14 7,75 8,59		mWs
Peak rate of fall of recovery current	$(di_r/dt)_{max}$					25 125 150		4044 2649 2147		A/μs



Vincotech

80-M312PMA100M7-K420A70  
datasheet

### Characteristic Values

Parameter	Symbol	Conditions					Values			Unit
		$V_{GS}$ [V]	$V_{GE}$ [V]	$V_{DS}$ [V]	$V_F$ [V]	$I_C$ [A] $I_D$ [A] $I_F$ [A]	$T_j$ [°C]	Min	Typ	

#### Brake Switch

##### Static

Gate-emitter threshold voltage	$V_{GE(th)}$			10	0,01	25	5,4	6	6,6	V
Collector-emitter saturation voltage	$V_{CE(sat)}$		15		100	25 125 150		1,61 1,82 1,91	1,85 <sup>(1)</sup>	V
Collector-emitter cut-off current	$I_{CES}$		0	1200		25			100	μA
Gate-emitter leakage current	$I_{GES}$		20	0		25			200	nA
Internal gate resistance	$r_g$							None		Ω
Input capacitance	$C_{ies}$							21000		pF
Output capacitance	$C_{oes}$		0	10		25		700		pF
Reverse transfer capacitance	$C_{res}$							280		pF
Gate charge	$Q_g$	$V_{CC} = 600$ V	0/15		100	25		700		nC

##### Thermal

Thermal resistance junction to sink <sup>(2)</sup>	$R_{th(j-s)}$	$\lambda_{paste} = 2,5$ W/mK (HPTP)						0,4		K/W
--	---------------	--	--	--	--	--	--	-----	--	-----

##### Dynamic

Turn-on delay time	$t_{d(on)}$	$R_{gon} = 2$ Ω $R_{goff} = 2$ Ω	±15	600	100	25		118,2		ns				
						125		118,2						
						150		117,6						
Rise time	$t_r$									25		10,2		ns
										125		12,4		
										150		13,4		
Turn-off delay time	$t_{d(off)}$									25		173,6		ns
						125		200,4						
						150		205,6						
Fall time	$t_f$					25		82,85		ns				
						125		96,38						
						150		106,77						
Turn-on energy (per pulse)	$E_{on}$	$Q_{tFWD} = 11,6$ μC $Q_{tFWD} = 17,27$ μC $Q_{tFWD} = 19,18$ μC				25		3,26		mWs				
						125		4,87						
						150		5,37						
Turn-off energy (per pulse)	$E_{off}$					25		6,6		mWs				
						125		8,77						
						150		9,49						



Vincotech

**80-M312PMA100M7-K420A70**  
datasheet

### Characteristic Values

Parameter	Symbol	Conditions					Values			Unit
		$V_{GE}$ [V] $V_{GS}$ [V]	$V_{CE}$ [V] $V_{DS}$ [V] $V_F$ [V]	$I_C$ [A] $I_D$ [A] $I_F$ [A]	$T_j$ [°C]	Min	Typ	Max		
<b>Brake Diode</b>										
<b>Static</b>										
Forward voltage	$V_F$			100	25 125 150		1,82 1,96 1,97	2,1 <sup>(1)</sup>		V
Reverse leakage current	$I_R$	$V_T = 1200$ V			25			40		μA
<b>Thermal</b>										
Thermal resistance junction to sink <sup>(2)</sup>	$R_{th(j-s)}$	$\lambda_{paste} = 2,5$ W/mK (HPTP)					0,64			K/W
<b>Dynamic</b>										
Peak recovery current	$I_{RM}$	$di/dt=9387$ A/μs $di/dt=7872$ A/μs $di/dt=8350$ A/μs	±15	600	100	25		178,25		A
Reverse recovery time	$t_{rr}$					125		165,9		
						150		164,61		
						25		149,24		
Recovered charge	$Q_r$					125		311,54		
						150		339,17		
		25		11,6						
Reverse recovered energy	$E_{rec}$	125		17,27						
		150		19,18						
		25		5,14						
Peak rate of fall of recovery current	$(di_{rr}/dt)_{max}$	125		7,75						
		150		8,59						
		25		4044						
		125		2649						
		150		2147						



### Characteristic Values

Parameter	Symbol	Conditions					Values			Unit
		$V_{GE}$ [V] $V_{GS}$ [V]	$V_{CE}$ [V] $V_{DS}$ [V] $V_F$ [V]	$I_C$ [A] $I_D$ [A] $I_F$ [A]	$T_j$ [°C]	Min	Typ	Max		

#### Rectifier Diode

##### Static

Forward voltage	$V_F$				45	25 125 150		1,01 0,929 0,92	1,21 <sup>(1)</sup> 1,1 <sup>(1)</sup>	V
Reverse leakage current	$I_R$	$V_r = 1600$ V				25			50	µA

##### Thermal

Thermal resistance junction to sink <sup>(2)</sup>	$R_{th(j-s)}$	$\lambda_{paste} = 2,5$ W/mK (HPTP)						0,59		K/W
--	---------------	--	--	--	--	--	--	------	--	-----

#### Thermistor

##### Static

Rated resistance	$R$					25		1		kΩ
Deviation of $R_{100}$	$\Delta_{R/R}$	$R_{100} = 1670$ Ω				100	-2		2	%
Maximum Current	$I_{max}$							3		mA
Power dissipation constant	$d$					25		0,76		mW/K
A-value	$A$							$7,635 \times 10^{-3}$		1/K
B-value	$B$							$1,73 \times 10^{-5}$		1/K <sup>2</sup>
Vincotech Thermistor Reference									E	

<sup>(1)</sup> Value at chip level

<sup>(2)</sup> Only valid with pre-applied Vincotech thermal interface material.





## Inverter Switch Characteristics

**figure 1.** IGBT

Typical output characteristics  
 $I_C = f(V_{CE})$

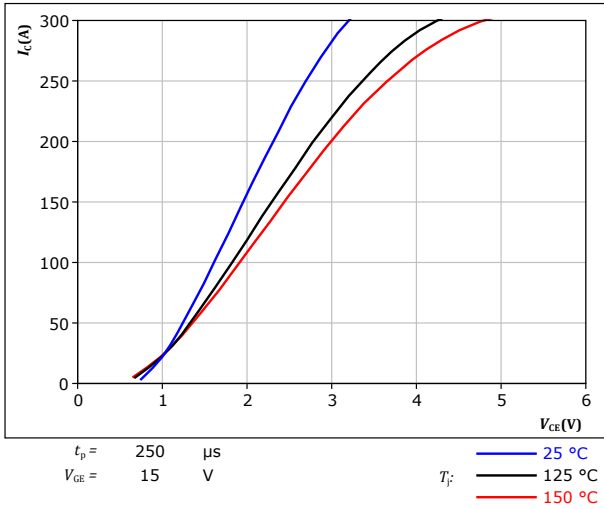

**figure 2.** IGBT

Typical output characteristics  
 $I_C = f(V_{CE})$

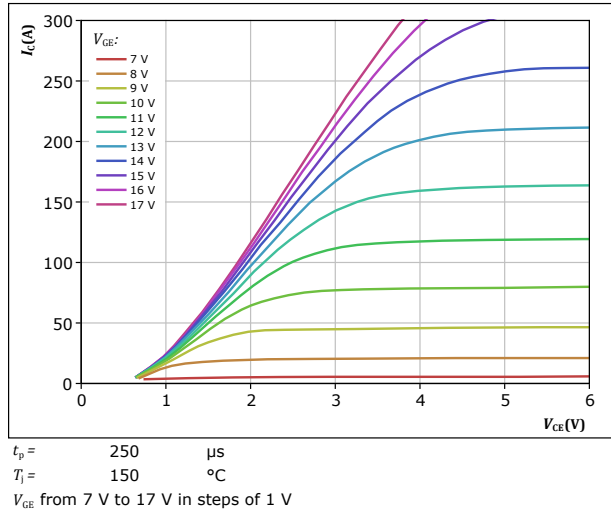

**figure 3.** IGBT

Typical transfer characteristics  
 $I_C = f(V_{GE})$

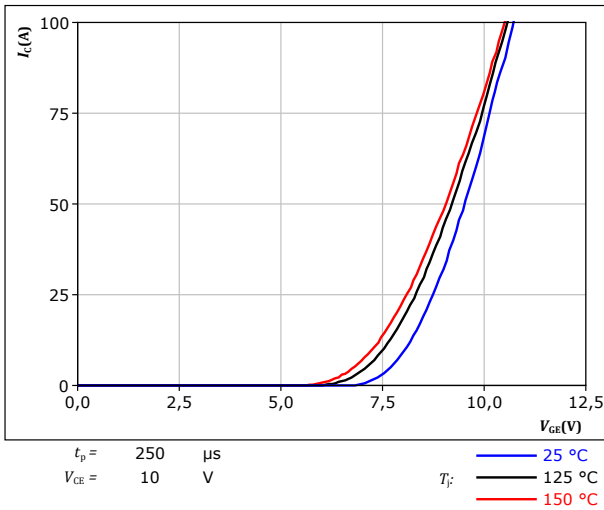

**figure 4.** IGBT

Transient thermal impedance as a function of pulse width  
 $Z_{th(j-s)} = f(t_p)$

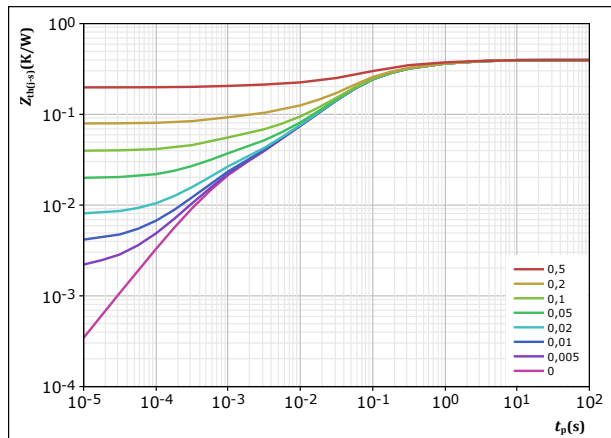

IGBT thermal model values

$R$ (K/W)	$\tau$ (s)
3,88E-02	2,55E+00
9,12E-02	3,93E-01
2,11E-01	6,52E-02
3,64E-02	9,40E-03
1,85E-02	6,78E-04



## Inverter Switch Characteristics

**figure 5.** IGBT

Safe operating area  
 $I_C = f(V_{CE})$

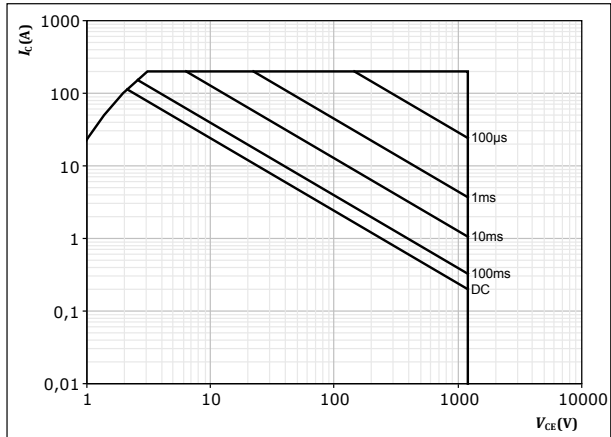

$D =$  single pulse  
 $T_s = 80 \text{ } ^\circ\text{C}$   
 $V_{GE} = 15 \text{ V}$   
 $T_j = T_{jmax}$

**figure 6.** IGBT

Gate voltage vs gate charge  
 $V_{GE} = f(Q_g)$

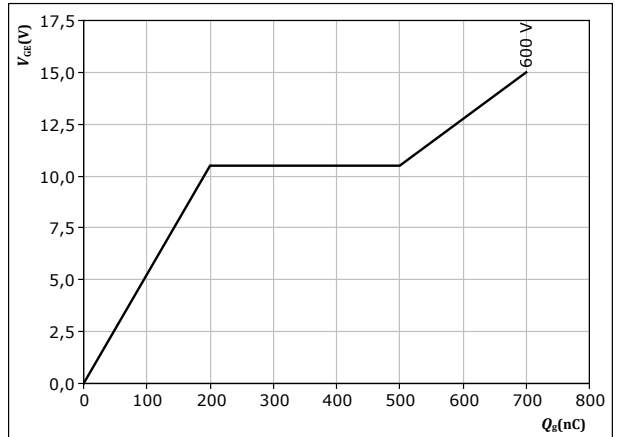

$I_C = 100 \text{ A}$   
 $T_j = 25 \text{ } ^\circ\text{C}$



## Inverter Diode Characteristics

figure 7. FWD

Typical forward characteristics

$$I_F = f(V_F)$$

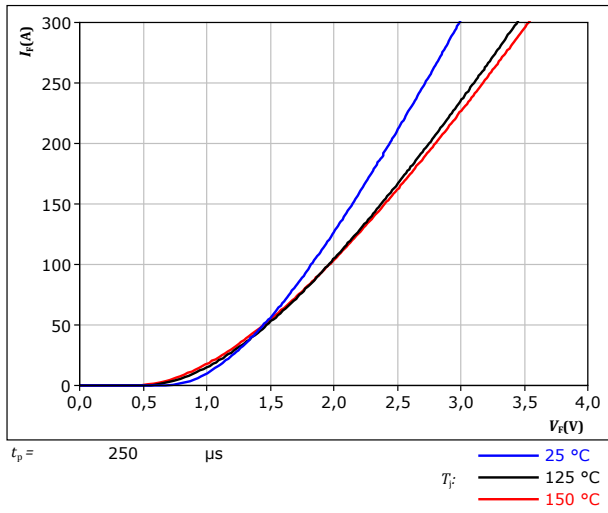
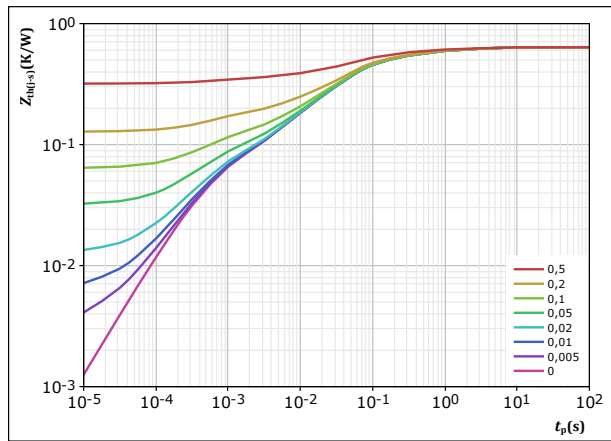

figure 8. FWD

Transient thermal impedance as a function of pulse width

$$Z_{th(j-s)} = f(t_p)$$



$D = \frac{t_p}{T}$   
 $R_{th(j-s)} = 0,638 \text{ K/W}$   
 FWD thermal model values

R (K/W)	$\tau$ (s)
5,39E-02	2,66E+00
1,18E-01	3,25E-01
3,25E-01	4,92E-02
8,49E-02	7,32E-03
5,61E-02	5,21E-04



### Brake Switch Characteristics

**figure 9.** IGBT

Typical output characteristics  
 $I_C = f(V_{CE})$

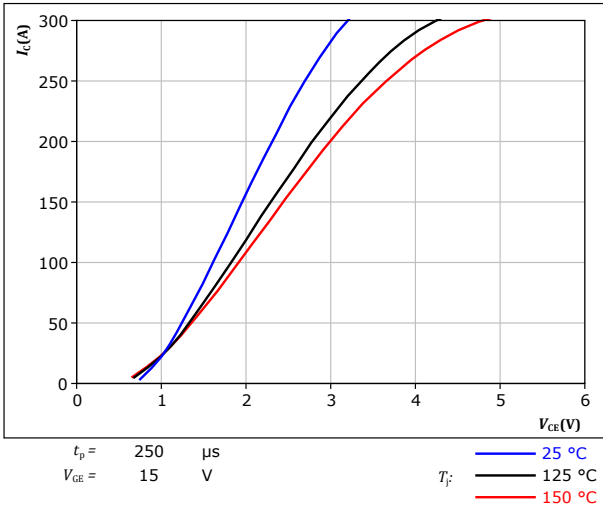

**figure 10.** IGBT

Typical output characteristics  
 $I_C = f(V_{CE})$

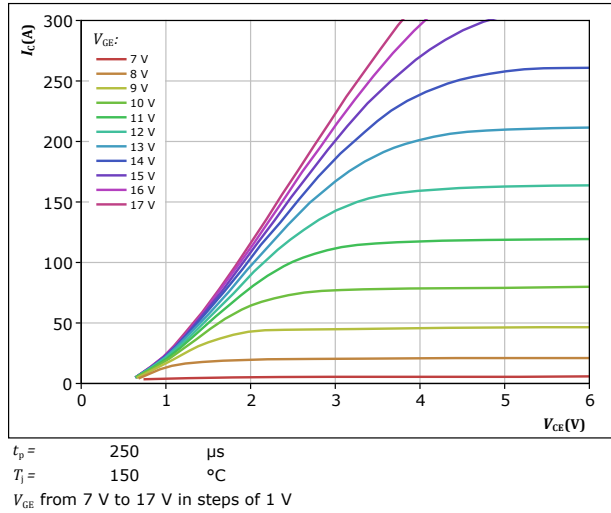

**figure 11.** IGBT

Typical transfer characteristics  
 $I_C = f(V_{GE})$

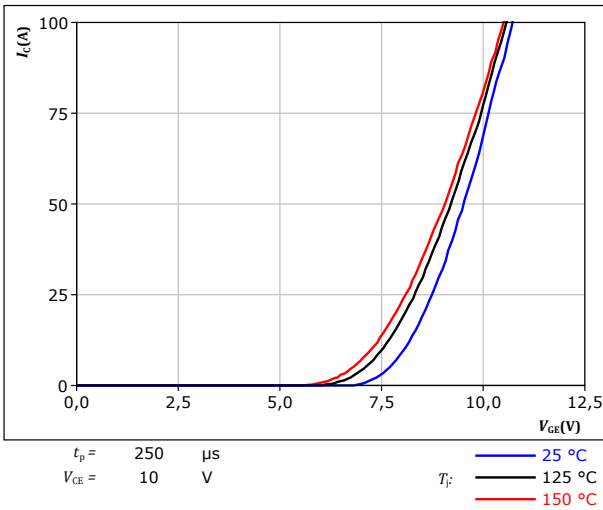

**figure 12.** IGBT

Transient thermal impedance as a function of pulse width  
 $Z_{th(j-s)} = f(t_p)$

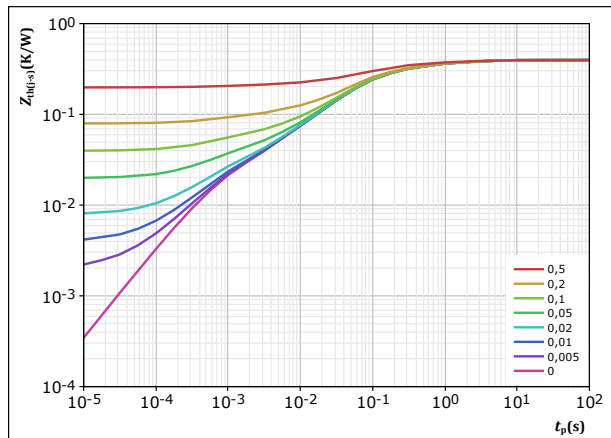

IGBT thermal model values

$R$ (K/W)	$\tau$ (s)
3,88E-02	2,55E+00
9,12E-02	3,93E-01
2,11E-01	6,52E-02
3,64E-02	9,40E-03
1,85E-02	6,78E-04



### Brake Switch Characteristics

**figure 13.** IGBT

Safe operating area  
 $I_C = f(V_{CE})$

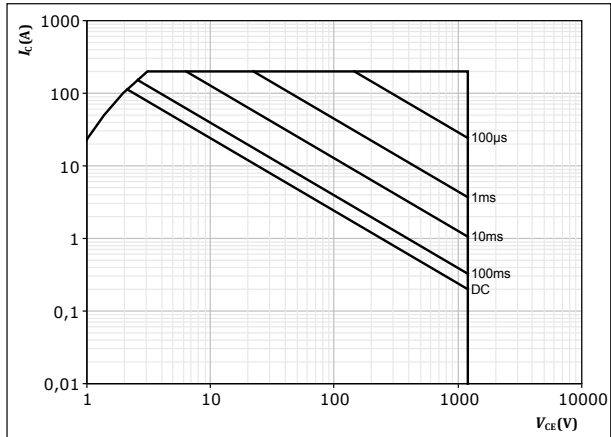

$D =$  single pulse  
 $T_s = 80 \text{ } ^\circ\text{C}$   
 $V_{GE} = 15 \text{ V}$   
 $T_j = T_{jmax}$

**figure 14.** IGBT

Gate voltage vs gate charge  
 $V_{GE} = f(Q_g)$

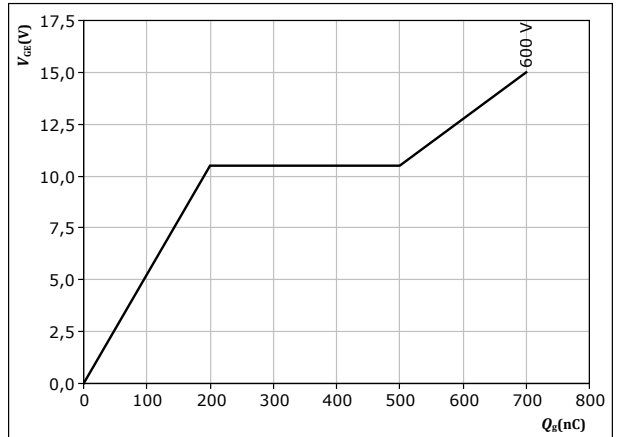

$I_C = 100 \text{ A}$   
 $T_j = 25 \text{ } ^\circ\text{C}$



## Brake Diode Characteristics

figure 15. FWD

Typical forward characteristics

$$I_F = f(V_F)$$

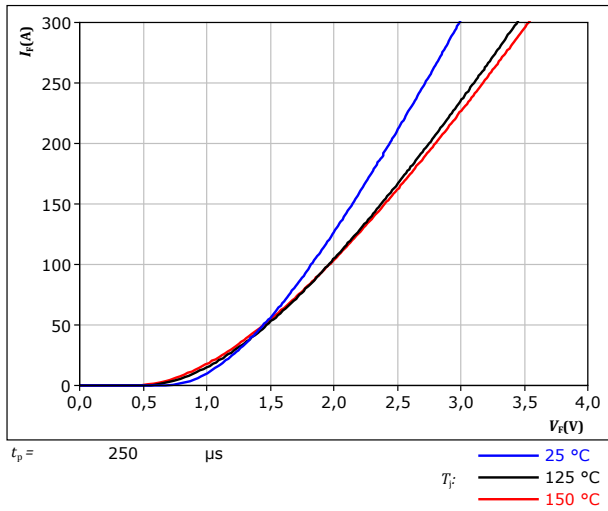
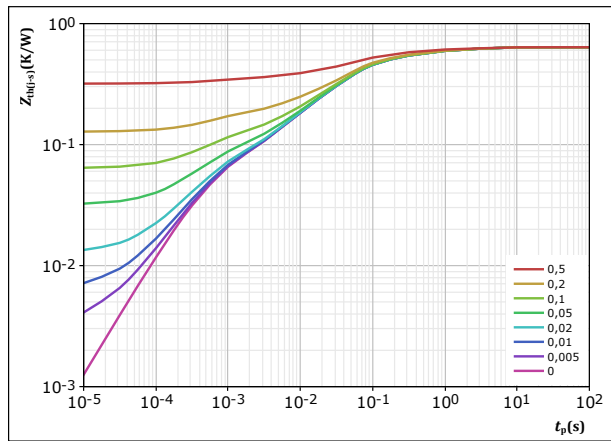

figure 16. FWD

Transient thermal impedance as a function of pulse width

$$Z_{th(j-s)} = f(t_p)$$



$D = t_p / T$   
 $R_{th(j-s)} = 0,638 \text{ K/W}$   
 FWD thermal model values

R (K/W)	$\tau$ (s)
5,39E-02	2,66E+00
1,18E-01	3,25E-01
3,25E-01	4,92E-02
8,49E-02	7,32E-03
5,61E-02	5,21E-04



## Rectifier Diode Characteristics

figure 17. Rectifier

Typical forward characteristics

$$I_F = f(V_F)$$

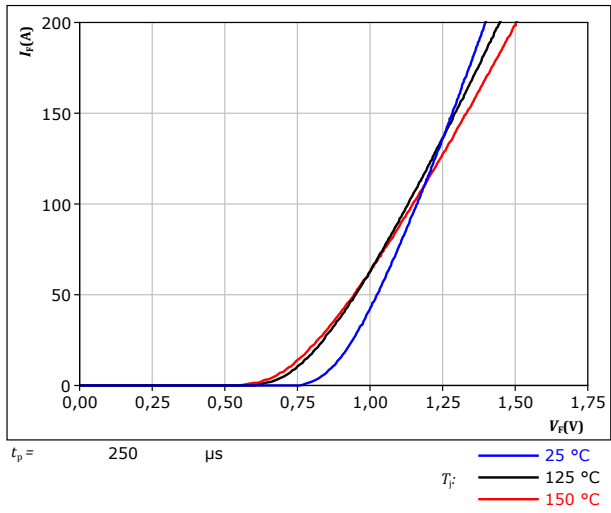
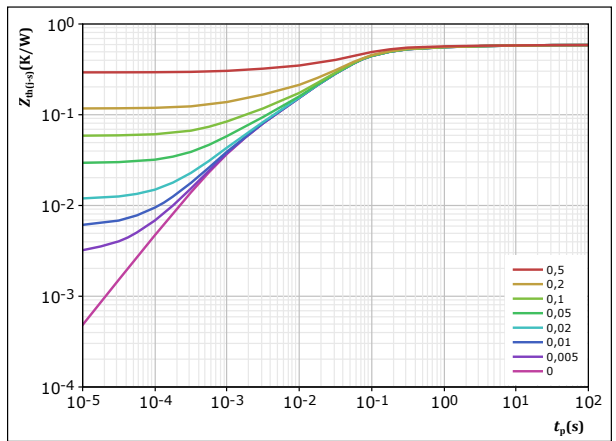

figure 18. Rectifier

Transient thermal impedance as a function of pulse width

$$Z_{th(j-s)} = f(t_p)$$



$D = \frac{t_p}{T}$   
 $R_{th(j-s)} = 0,586 \text{ K/W}$

Rectifier thermal model values

$R$ (K/W)	$\tau$ (s)
2,18E-02	8,76E+00
4,09E-02	7,46E-01
1,08E-01	1,33E-01
3,14E-01	4,45E-02
5,85E-02	8,66E-03
3,93E-02	1,33E-03
2,71E-03	6,42E-04



## Thermistor Characteristics

figure 19. Thermistor

Typical PTC characteristic as function of temperature

$$R_T = f(T)$$

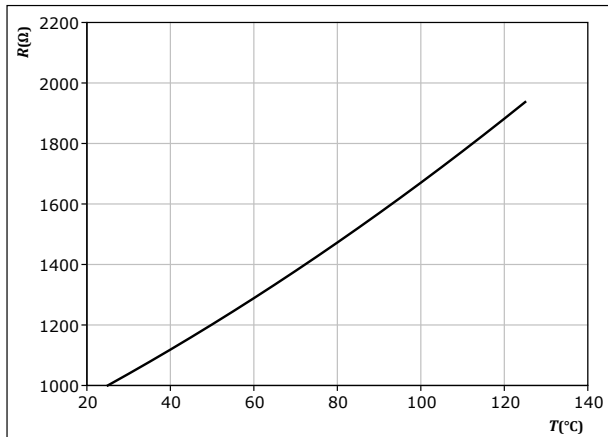





## Inverter Switching Characteristics

**figure 20.** IGBT

Typical switching energy losses as a function of collector current  
 $E = f(I_c)$

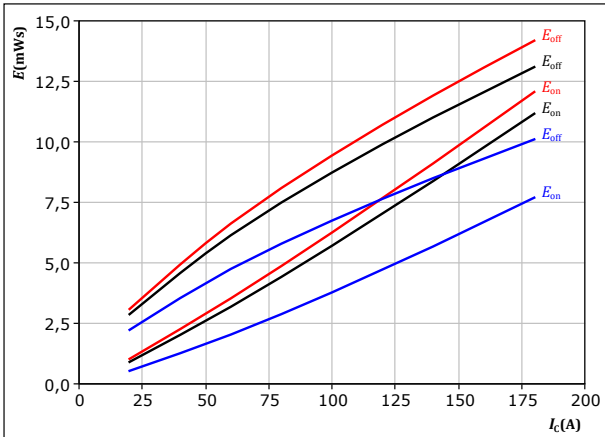

With an inductive load at  
 $V_{CE} = 600$  V  
 $V_{GE} = \pm 15$  V  
 $R_{gon} = 2$   $\Omega$   
 $R_{goff} = 2$   $\Omega$   
 $T_j$ : 25 °C, 125 °C, 150 °C

**figure 21.** IGBT

Typical switching energy losses as a function of IGBT turn on gate resistor  
 $E = f(R_g)$

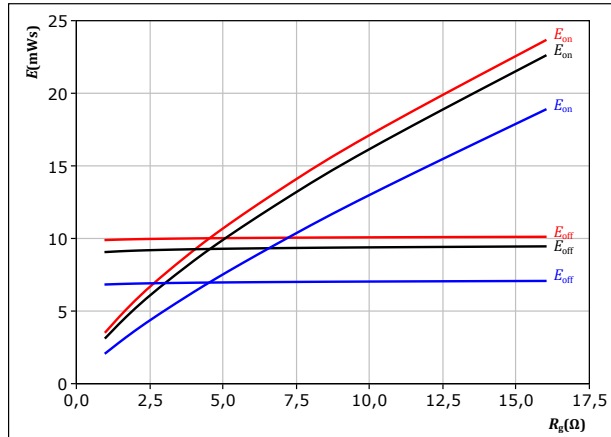

With an inductive load at  
 $V_{CE} = 600$  V  
 $V_{GE} = \pm 15$  V  
 $I_c = 100$  A  
 $T_j$ : 25 °C, 125 °C, 150 °C

**figure 22.** FWD

Typical reverse recovered energy loss as a function of collector current  
 $E_{rec} = f(I_c)$

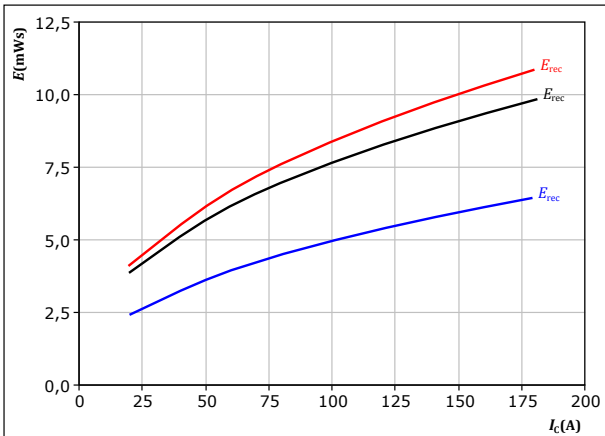

With an inductive load at  
 $V_{CE} = 600$  V  
 $V_{GE} = \pm 15$  V  
 $R_{gon} = 2$   $\Omega$   
 $T_j$ : 25 °C, 125 °C, 150 °C

**figure 23.** FWD

Typical reverse recovered energy loss as a function of IGBT turn on gate resistor  
 $E_{rec} = f(R_g)$

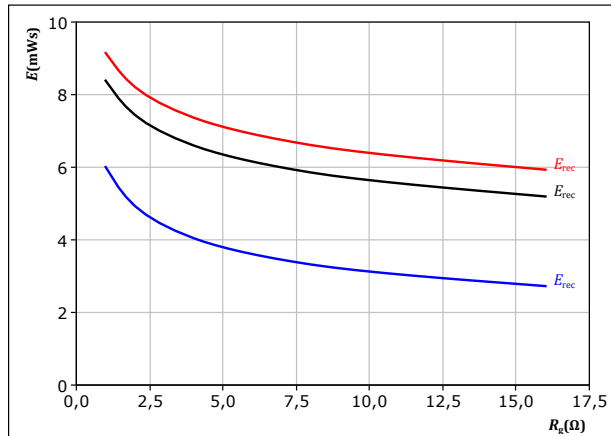

With an inductive load at  
 $V_{CE} = 600$  V  
 $V_{GE} = \pm 15$  V  
 $I_c = 100$  A  
 $T_j$ : 25 °C, 125 °C, 150 °C



## Inverter Switching Characteristics

**figure 24.** IGBT

Typical switching times as a function of collector current  
 $t = f(I_c)$

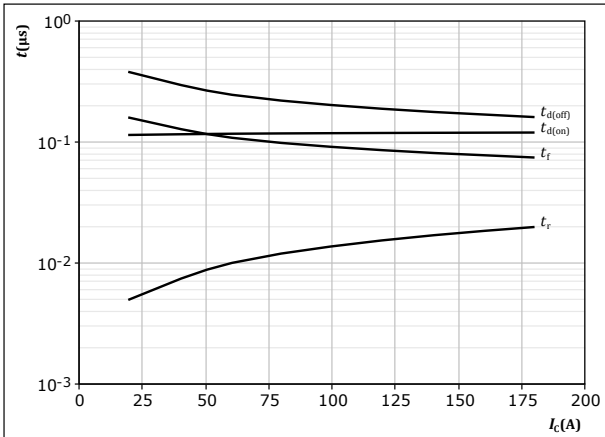

With an inductive load at  
 $T_j = 150$  °C  
 $V_{CE} = 600$  V  
 $V_{GE} = \pm 15$  V  
 $R_{gon} = 2$  Ω  
 $R_{goff} = 2$  Ω

**figure 25.** IGBT

Typical switching times as a function of IGBT turn on gate resistor  
 $t = f(R_g)$

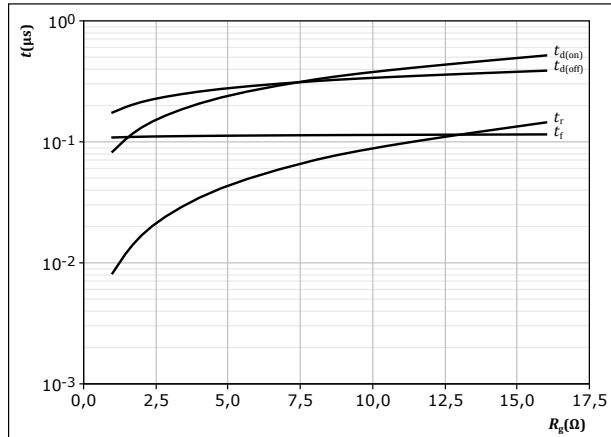

With an inductive load at  
 $T_j = 150$  °C  
 $V_{CE} = 600$  V  
 $V_{GE} = \pm 15$  V  
 $I_c = 100$  A

**figure 26.** FWD

Typical reverse recovery time as a function of collector current  
 $t_{rr} = f(I_c)$

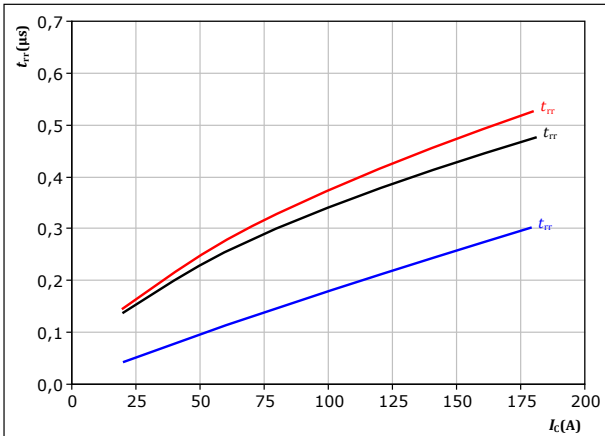

With an inductive load at  
 $V_{CE} = 600$  V  
 $V_{GE} = \pm 15$  V  
 $R_{gon} = 2$  Ω  
 $T_j$ : — 25 °C  
— 125 °C  
— 150 °C

**figure 27.** FWD

Typical reverse recovery time as a function of IGBT turn on gate resistor  
 $t_{rr} = f(R_{gon})$

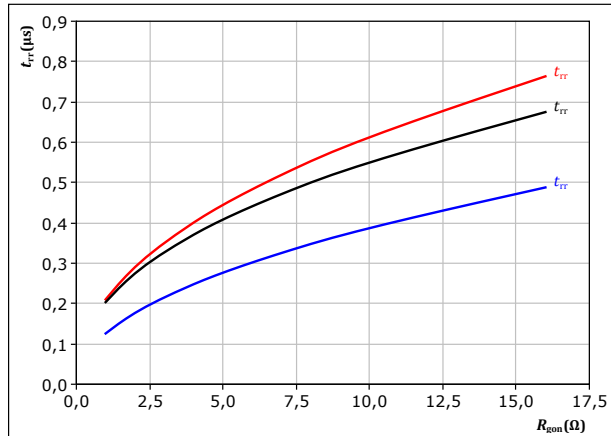

With an inductive load at  
 $V_{CE} = 600$  V  
 $V_{GE} = \pm 15$  V  
 $I_c = 100$  A  
 $T_j$ : — 25 °C  
— 125 °C  
— 150 °C



## Inverter Switching Characteristics

**figure 28.** FWD

Typical recovered charge as a function of collector current

$$Q_r = f(I_c)$$

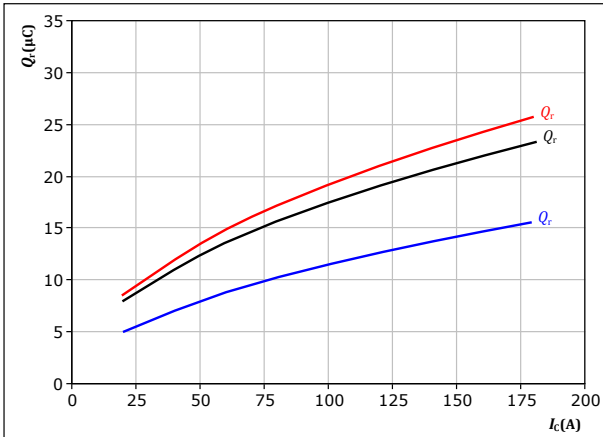

With an inductive load at

$V_{CE} = 600 \text{ V}$   
 $V_{GE} = \pm 15 \text{ V}$   
 $R_{gon} = 2 \ \Omega$

$T_j$ : — 25 °C  
— 125 °C  
— 150 °C

**figure 29.** FWD

Typical recovered charge as a function of IGBT turn on gate resistor

$$Q_r = f(R_{gon})$$

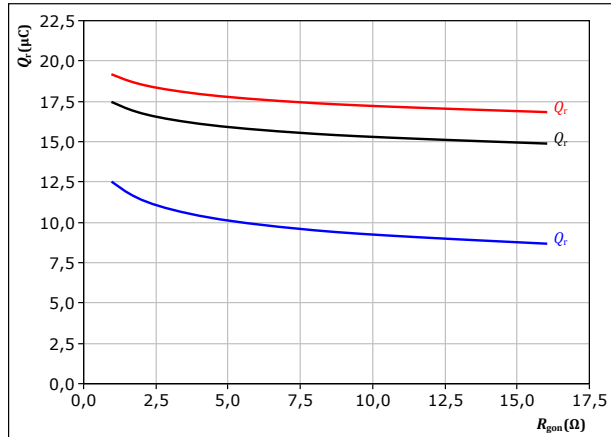

With an inductive load at

$V_{CE} = 600 \text{ V}$   
 $V_{GE} = \pm 15 \text{ V}$   
 $I_c = 100 \text{ A}$

$T_j$ : — 25 °C  
— 125 °C  
— 150 °C

**figure 30.** FWD

Typical peak reverse recovery current as a function of collector current

$$I_{RM} = f(I_c)$$

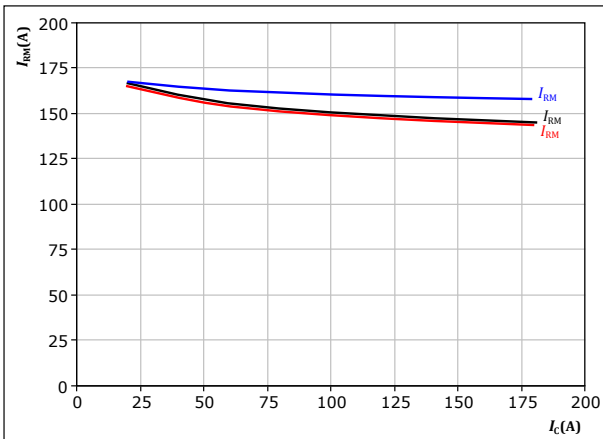

With an inductive load at

$V_{CE} = 600 \text{ V}$   
 $V_{GE} = \pm 15 \text{ V}$   
 $R_{gon} = 2 \ \Omega$

$T_j$ : — 25 °C  
— 125 °C  
— 150 °C

**figure 31.** FWD

Typical peak reverse recovery current as a function of IGBT turn on gate resistor

$$I_{RM} = f(R_{gon})$$

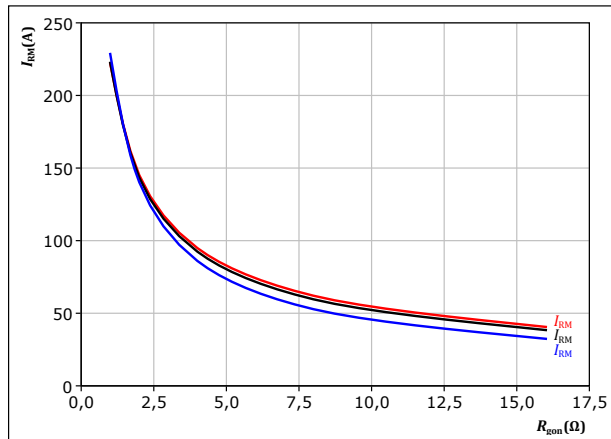

With an inductive load at

$V_{CE} = 600 \text{ V}$   
 $V_{GE} = \pm 15 \text{ V}$   
 $I_c = 100 \text{ A}$

$T_j$ : — 25 °C  
— 125 °C  
— 150 °C



## Inverter Switching Characteristics

**figure 32.** FWD

Typical rate of fall of forward and reverse recovery current as a function of collector current  
 $di_f/dt, di_{rr}/dt = f(I_C)$

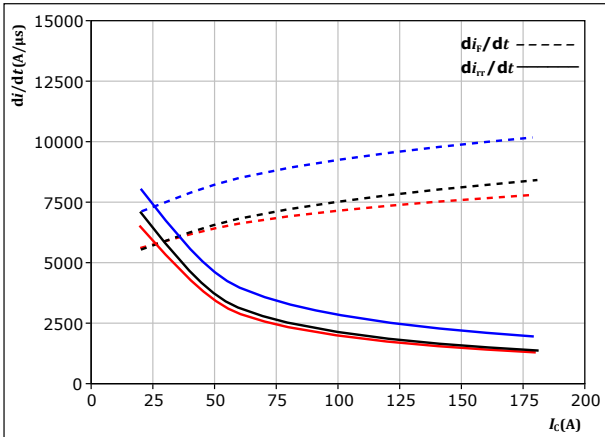

With an inductive load at

$V_{CE} =$	600	V	$T_j:$	25 °C
$V_{GE} =$	±15	V		125 °C
$R_{gon} =$	2	Ω		150 °C

**figure 33.** FWD

Typical rate of fall of forward and reverse recovery current as a function of turn on gate resistor  
 $di_f/dt, di_{rr}/dt = f(R_{gon})$

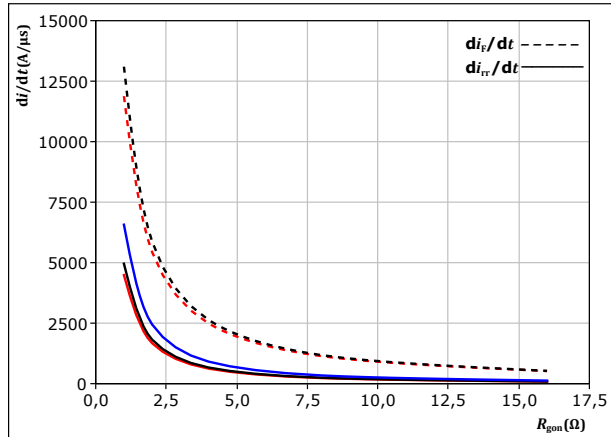

With an inductive load at

$V_{CE} =$	600	V	$T_j:$	25 °C
$V_{GE} =$	±15	V		125 °C
$I_C =$	100	A		150 °C

**figure 34.** IGBT

Reverse bias safe operating area

$I_C = f(V_{CE})$

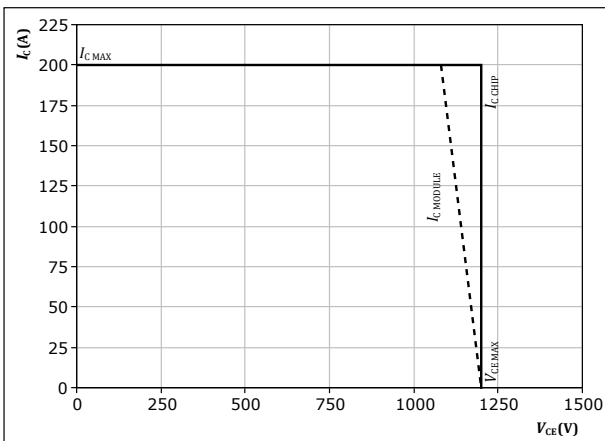

At  $T_j = 150$  °C  
 $R_{gon} = 2$  Ω  
 $R_{goff} = 2$  Ω



## Brake Switching Characteristics

**figure 35.** IGBT

Typical switching energy losses as a function of collector current  
 $E = f(I_c)$

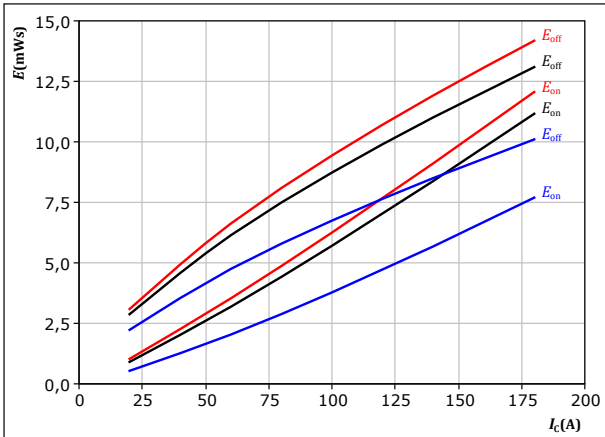

With an inductive load at

$V_{CE} =$	600	V	$T_j:$	—	25 °C
$V_{GE} =$	±15	V		—	125 °C
$R_{gon} =$	2	Ω		—	150 °C
$R_{goff} =$	2	Ω			

**figure 36.** IGBT

Typical switching energy losses as a function of IGBT turn on gate resistor  
 $E = f(R_g)$

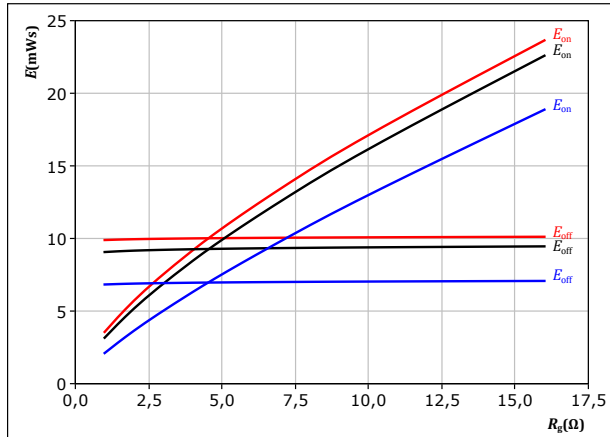

With an inductive load at

$V_{CE} =$	600	V	$T_j:$	—	25 °C
$V_{GE} =$	±15	V		—	125 °C
$I_c =$	100	A		—	150 °C

**figure 37.** FWD

Typical reverse recovered energy loss as a function of collector current  
 $E_{rec} = f(I_c)$

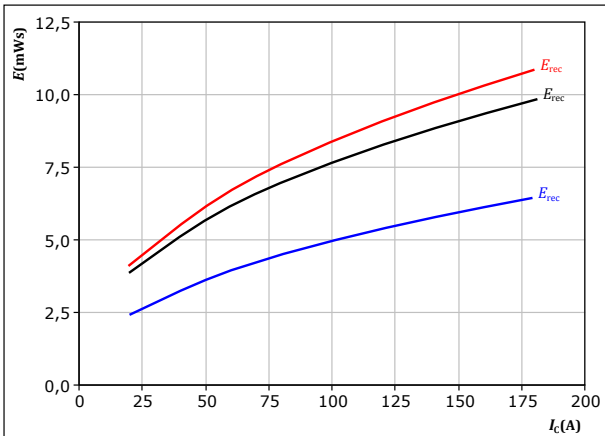

With an inductive load at

$V_{CE} =$	600	V	$T_j:$	—	25 °C
$V_{GE} =$	±15	V		—	125 °C
$R_{gon} =$	2	Ω		—	150 °C

**figure 38.** FWD

Typical reverse recovered energy loss as a function of IGBT turn on gate resistor  
 $E_{rec} = f(R_g)$

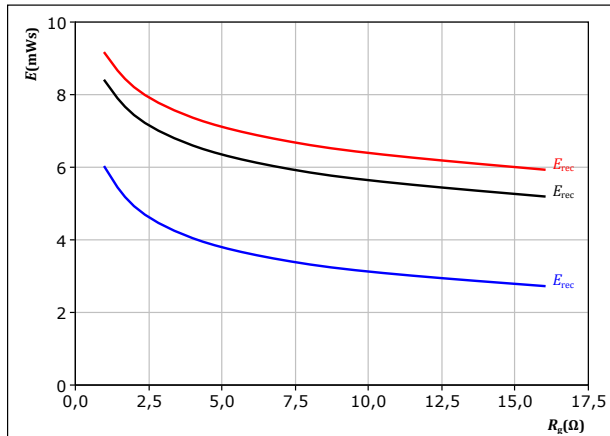

With an inductive load at

$V_{CE} =$	600	V	$T_j:$	—	25 °C
$V_{GE} =$	±15	V		—	125 °C
$I_c =$	100	A		—	150 °C



## Brake Switching Characteristics

**figure 39.** IGBT

Typical switching times as a function of collector current  
 $t = f(I_c)$

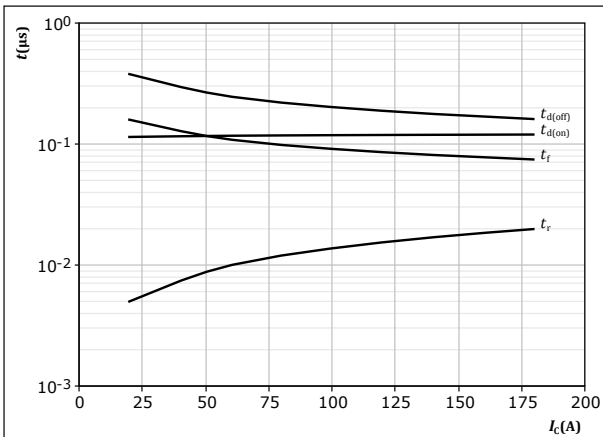

With an inductive load at  
 $T_j = 150 \text{ }^\circ\text{C}$   
 $V_{CE} = 600 \text{ V}$   
 $V_{GE} = \pm 15 \text{ V}$   
 $R_{gon} = 2 \text{ } \Omega$   
 $R_{goff} = 2 \text{ } \Omega$

**figure 40.** IGBT

Typical switching times as a function of IGBT turn on gate resistor  
 $t = f(R_g)$

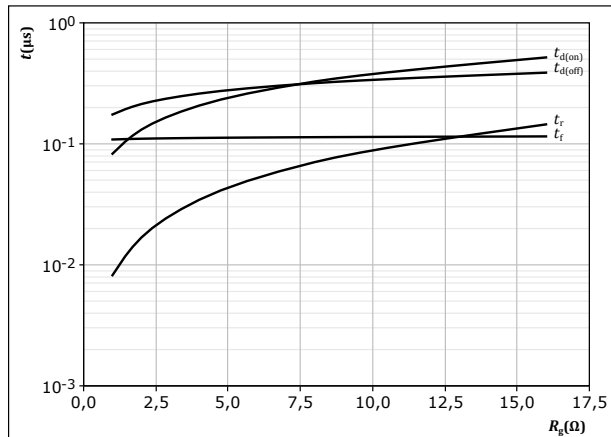

With an inductive load at  
 $T_j = 150 \text{ }^\circ\text{C}$   
 $V_{CE} = 600 \text{ V}$   
 $V_{GE} = \pm 15 \text{ V}$   
 $I_c = 100 \text{ A}$

**figure 41.** FWD

Typical reverse recovery time as a function of collector current  
 $t_{rr} = f(I_c)$

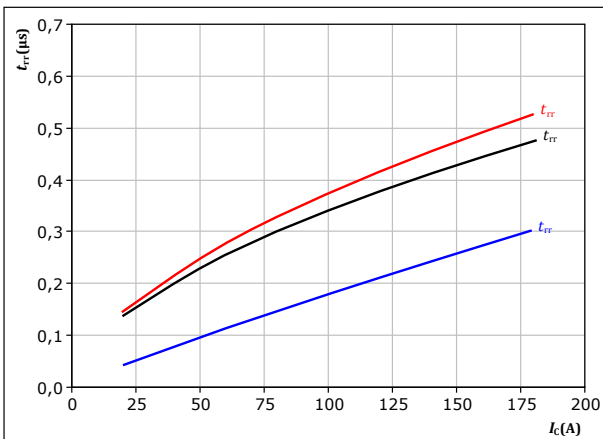

With an inductive load at  
 $V_{CE} = 600 \text{ V}$   
 $V_{GE} = \pm 15 \text{ V}$   
 $R_{gon} = 2 \text{ } \Omega$   
 $T_j:$  — 25 °C  
 — 125 °C  
 — 150 °C

**figure 42.** FWD

Typical reverse recovery time as a function of IGBT turn on gate resistor  
 $t_{rr} = f(R_{gon})$

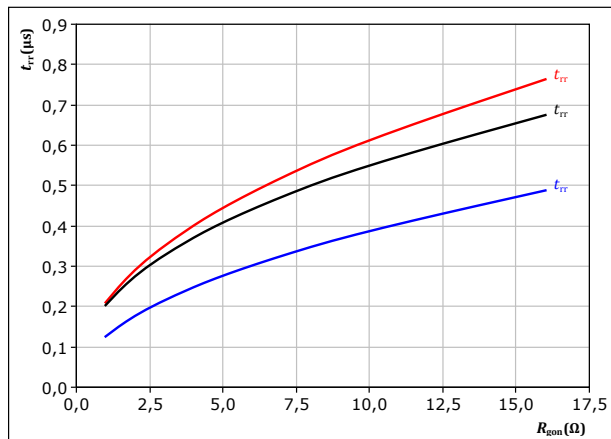

With an inductive load at  
 $V_{CE} = 600 \text{ V}$   
 $V_{GE} = \pm 15 \text{ V}$   
 $I_c = 100 \text{ A}$   
 $T_j:$  — 25 °C  
 — 125 °C  
 — 150 °C



## Brake Switching Characteristics

figure 43. FWD

Typical recovered charge as a function of collector current

$$Q_r = f(I_c)$$

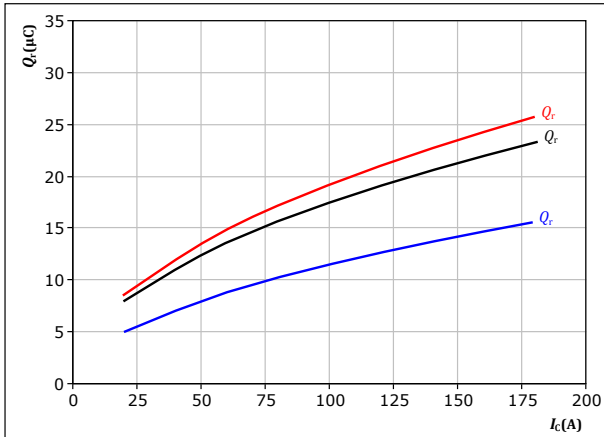

With an inductive load at

$V_{CE} = 600$  V  
 $V_{GE} = \pm 15$  V  
 $R_{gon} = 2$  Ω

$T_j$ : — 25 °C  
— 125 °C  
— 150 °C

figure 44. FWD

Typical recovered charge as a function of IGBT turn on gate resistor

$$Q_r = f(R_{gon})$$

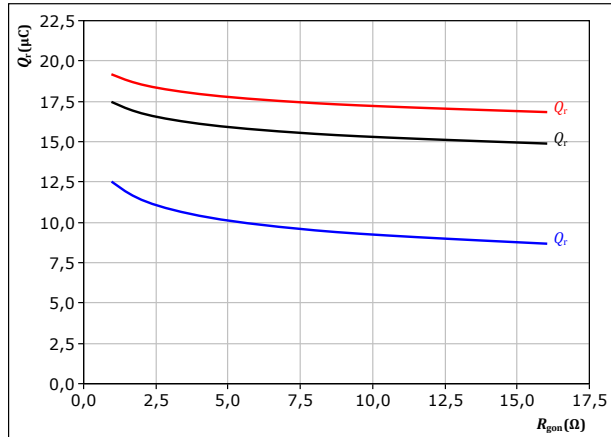

With an inductive load at

$V_{CE} = 600$  V  
 $V_{GE} = \pm 15$  V  
 $I_c = 100$  A

$T_j$ : — 25 °C  
— 125 °C  
— 150 °C

figure 45. FWD

Typical peak reverse recovery current as a function of collector current

$$I_{RM} = f(I_c)$$

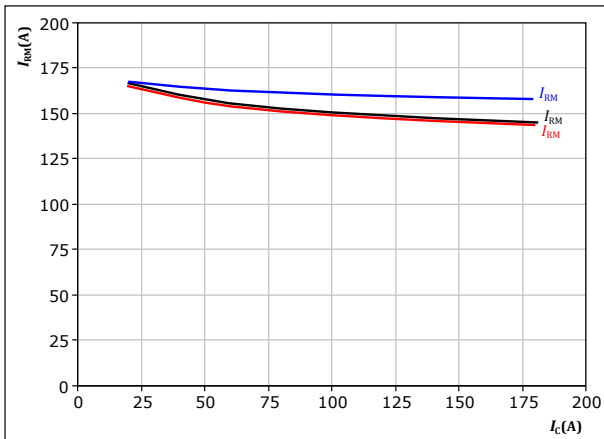

With an inductive load at

$V_{CE} = 600$  V  
 $V_{GE} = \pm 15$  V  
 $R_{gon} = 2$  Ω

$T_j$ : — 25 °C  
— 125 °C  
— 150 °C

figure 46. FWD

Typical peak reverse recovery current as a function of IGBT turn on gate resistor

$$I_{RM} = f(R_{gon})$$

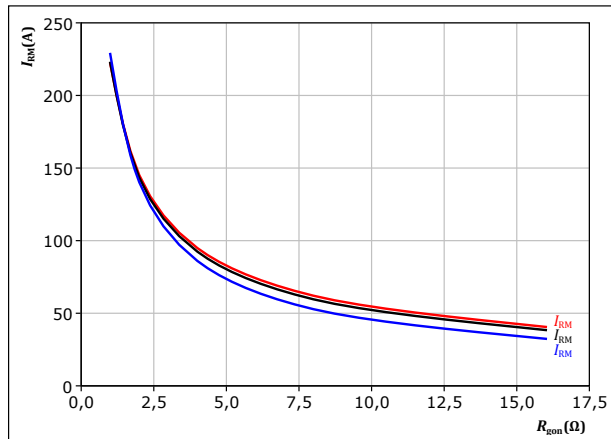

With an inductive load at

$V_{CE} = 600$  V  
 $V_{GE} = \pm 15$  V  
 $I_c = 100$  A

$T_j$ : — 25 °C  
— 125 °C  
— 150 °C



## Brake Switching Characteristics

**figure 47.** FWD

Typical rate of fall of forward and reverse recovery current as a function of collector current  
 $di_f/dt, di_r/dt = f(I_C)$

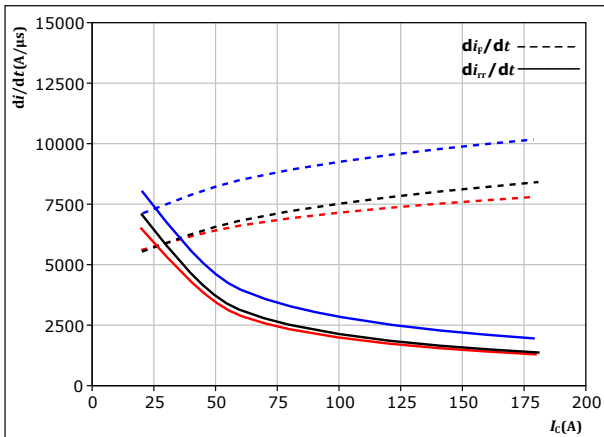

With an inductive load at

$V_{CE} = 600 \text{ V}$   
 $V_{GE} = \pm 15 \text{ V}$   
 $R_{gon} = 2 \text{ } \Omega$

$T_j$ :  
— 25 °C  
— 125 °C  
— 150 °C

**figure 48.** FWD

Typical rate of fall of forward and reverse recovery current as a function of turn on gate resistor  
 $di_f/dt, di_r/dt = f(R_{gon})$

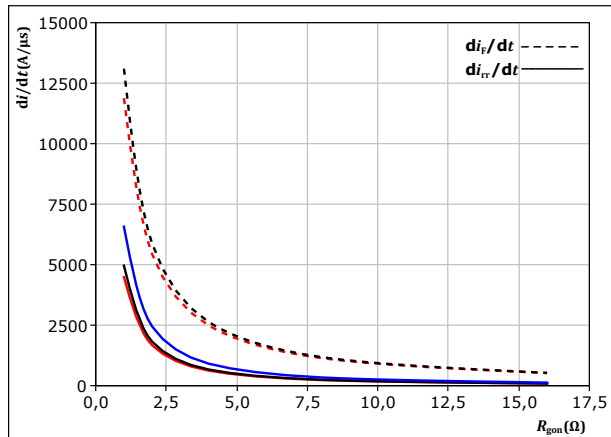

With an inductive load at

$V_{CE} = 600 \text{ V}$   
 $V_{GE} = \pm 15 \text{ V}$   
 $I_C = 100 \text{ A}$

$T_j$ :  
— 25 °C  
— 125 °C  
— 150 °C

**figure 49.** IGBT

Reverse bias safe operating area

$I_C = f(V_{CE})$

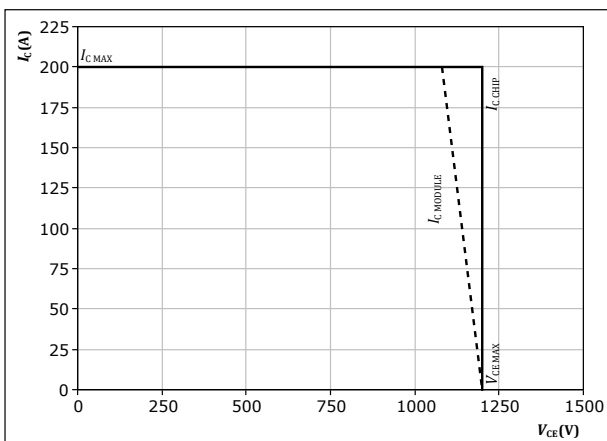

At  $T_j = 150 \text{ } ^\circ\text{C}$   
 $R_{gon} = 2 \text{ } \Omega$   
 $R_{goff} = 2 \text{ } \Omega$





### Switching Definitions

**figure 50. IGBT**  
Turn-off Switching Waveforms & definition of  $t_{doff}$ ,  $t_{Eoff}$  ( $t_{Eoff}$  = integrating time for  $E_{off}$ )

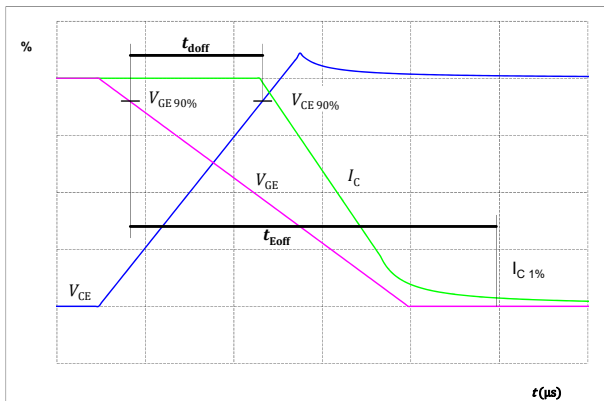

**figure 51. IGBT**  
Turn-on Switching Waveforms & definition of  $t_{don}$ ,  $t_{Eon}$  ( $t_{Eon}$  = integrating time for  $E_{on}$ )

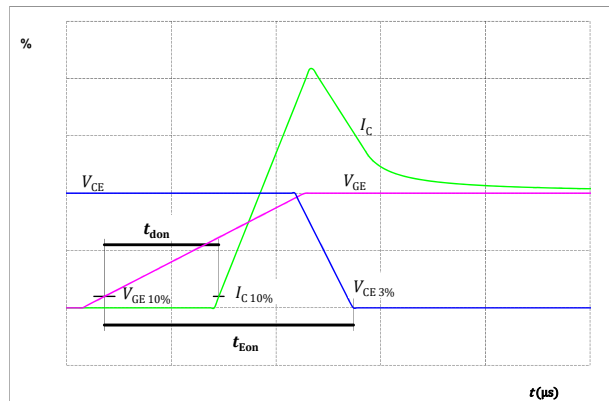

**figure 52. IGBT**  
Turn-off Switching Waveforms & definition of  $t_f$

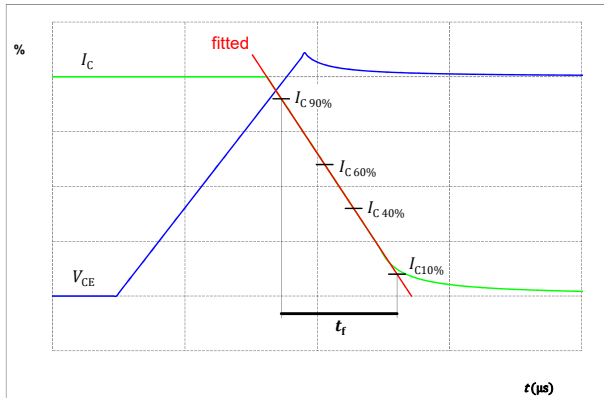

**figure 53. IGBT**  
Turn-on Switching Waveforms & definition of  $t_r$

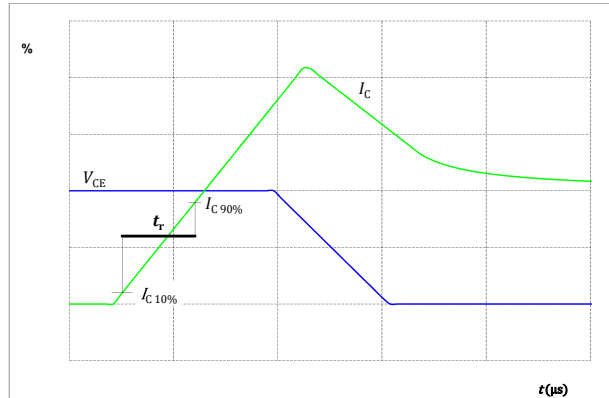



### Switching Definitions

figure 54. FWD

Turn-off Switching Waveforms & definition of  $t_{rr}$

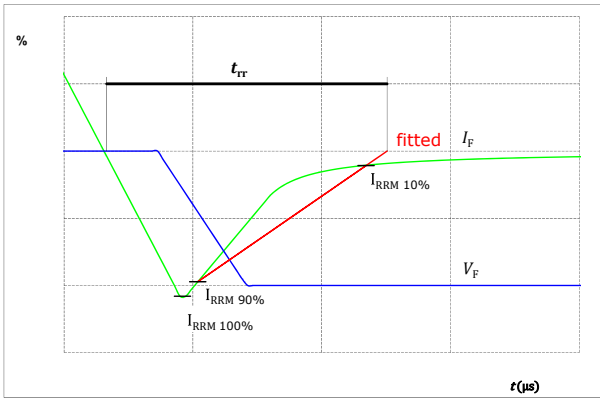
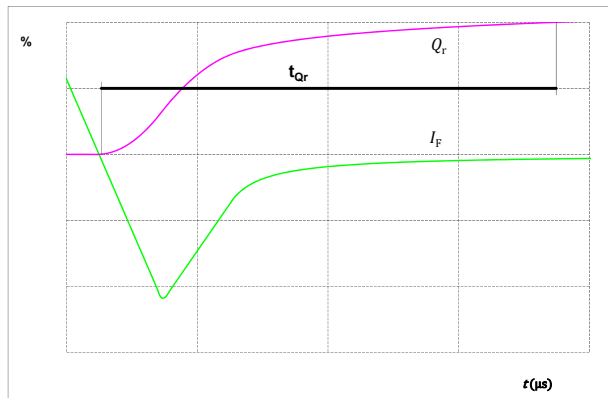

figure 55. FWD

Turn-on Switching Waveforms & definition of  $t_{Qr}$  ( $t_{Qr}$  = integrating time for  $Q_r$ )





Vincotech

Ordering Code	
Version	Ordering Code
With std lid (6.5mm height) + no thermal grease	80-M312PMA100M7-K420A70-/0A/
With thin lid (2.8mm height) + no thermal grease	80-M312PMA100M7-K420A70-/0B/
With std lid (6.5mm height) + thermal grease (0,8 W/mK, P12, silicone-based)	80-M312PMA100M7-K420A70-/1A/
With thin lid (2.8mm height) + thermal grease (0,8 W/mK, P12, silicone-based)	80-M312PMA100M7-K420A70-/1B/
With std lid (6.5mm height) + thermal grease (2,5 W/mK, TG20032, silicone-free)	80-M312PMA100M7-K420A70-/4A/
With thin lid (2.8mm height) + thermal grease (2,5 W/mK, TG20032, silicone-free)	80-M312PMA100M7-K420A70-/4B/
With std lid (6.5mm height) + thermal grease (2,5 W/mK, HPTP, silicone-based)	80-M312PMA100M7-K420A70-/5A/
With thin lid (2.8mm height) + thermal grease (2,5 W/mK, HPTP, silicone-based)	80-M312PMA100M7-K420A70-/5B/

Marking						
Text	Name		Date code	UL & VIN	Lot	Serial
		NN-NNNNNNNNNNNNNN- TTTTTTTV		WWYY	UL VIN	LLLLL
Datamatrix		Type&Ver	Lot number	Serial	Date code	
	TTTTTTTV	LLLLL	SSSS	WWYY		

Outline							
Pin table [mm]							
Pin	X	Y	Function	45	-25,9	2,2	DC+Br
1	15,83	-25,3	G16	46	-29,18	8,74	Br
2	15,83	-6,4	S16	47	-29,18	11,94	Br
3	15,83	-3,2	Ph3	48	-32,82	8,74	Br
4	15,83	0	Ph3	49	-32,82	11,94	Br
5	15,83	3,2	Ph3	50	-35,68	22,1	DC-Br
6	15,83	6,4	Ph3	51	-35,68	25,3	DC-Br
7	not assembled			52	-36,58	-25,3	DC+rect
8	not assembled			53	-36,58	-22,1	DC+rect
9	15,83	22,1	G15	54	not assembled		
10	15,83	25,3	S15	55	not assembled		
11	8,13	-25,3	Therm2	56	-36,58	-9,3	DC+Inv
12	8,13	-22,1	Therm1	57	-36,58	-6,1	DC+Inv
13	not assembled			58	-39,32	15,7	G27
14	8,13	25,3	DC-Inv	59	-39,32	18,9	S27
15	not assembled			60	-39,32	22,1	DC-Br
16	1,82	-12,18	S14	61	-39,32	25,3	DC-Br
17	1,82	-8,98	Ph2	62	-40,22	-25,3	DC+rect
18	1,82	-5,79	Ph2	63	-40,22	-22,1	DC+rect
19	0,43	22,1	G13	64	not assembled		
20	0,43	25,3	S13	65	not assembled		
21	-1,07	-25,3	G14	66	-40,22	-9,3	DC+Inv
22	not assembled			67	-40,22	-6,09	DC+Inv
23	not assembled			68	-50,18	-25,3	ACIn1
24	-1,82	-8,98	Ph2	69	-50,18	-22,1	ACIn1
25	-1,82	-5,79	Ph2	70	not assembled		
26	not assembled			71	not assembled		
27	not assembled			72	-50,18	-9,5	ACIn2
28	-7,27	25,3	DC-Inv	73	-50,18	-6,3	ACIn2
29	-14,97	22,1	G11	74	-50,18	6,3	DC-rect
30	-14,97	25,3	S11	75	-50,18	9,5	DC-rect
31	not assembled			76	-50,18	22,1	ACIn3
32	-16,05	-11,82	Ph1	77	-50,18	25,3	ACIn3
33	-16,05	-8,63	Ph1	78	-53,82	-25,3	ACIn1
34	-16,05	-5,42	S12	79	-53,82	-22,1	ACIn1
35	-19,22	-25,3	G12	80	not assembled		
36	not assembled			81	not assembled		
37	-19,7	-11,82	Ph1	82	-53,82	-9,5	ACIn2
38	-19,7	-8,62	Ph1	83	-53,82	-6,3	ACIn2
39	not assembled			84	not assembled		
40	-22,26	-1	DC+Br	85	-53,82	6,3	DC-rect
41	-22,26	2,2	DC+Br	86	-53,82	9,5	DC-rect
42	-22,67	22,1	DC-Inv	87	-53,82	22,1	ACIn3
43	-22,67	25,3	DC-Inv	88	-53,82	25,3	ACIn3
44	-25,9	-1	DC+Br				

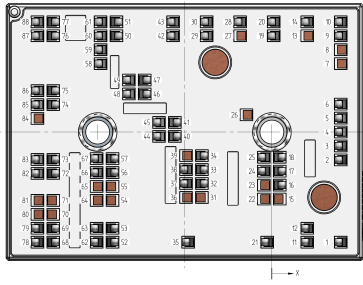

Pad positions refers to center point. For more informations on pad design please see package data



Vincotech

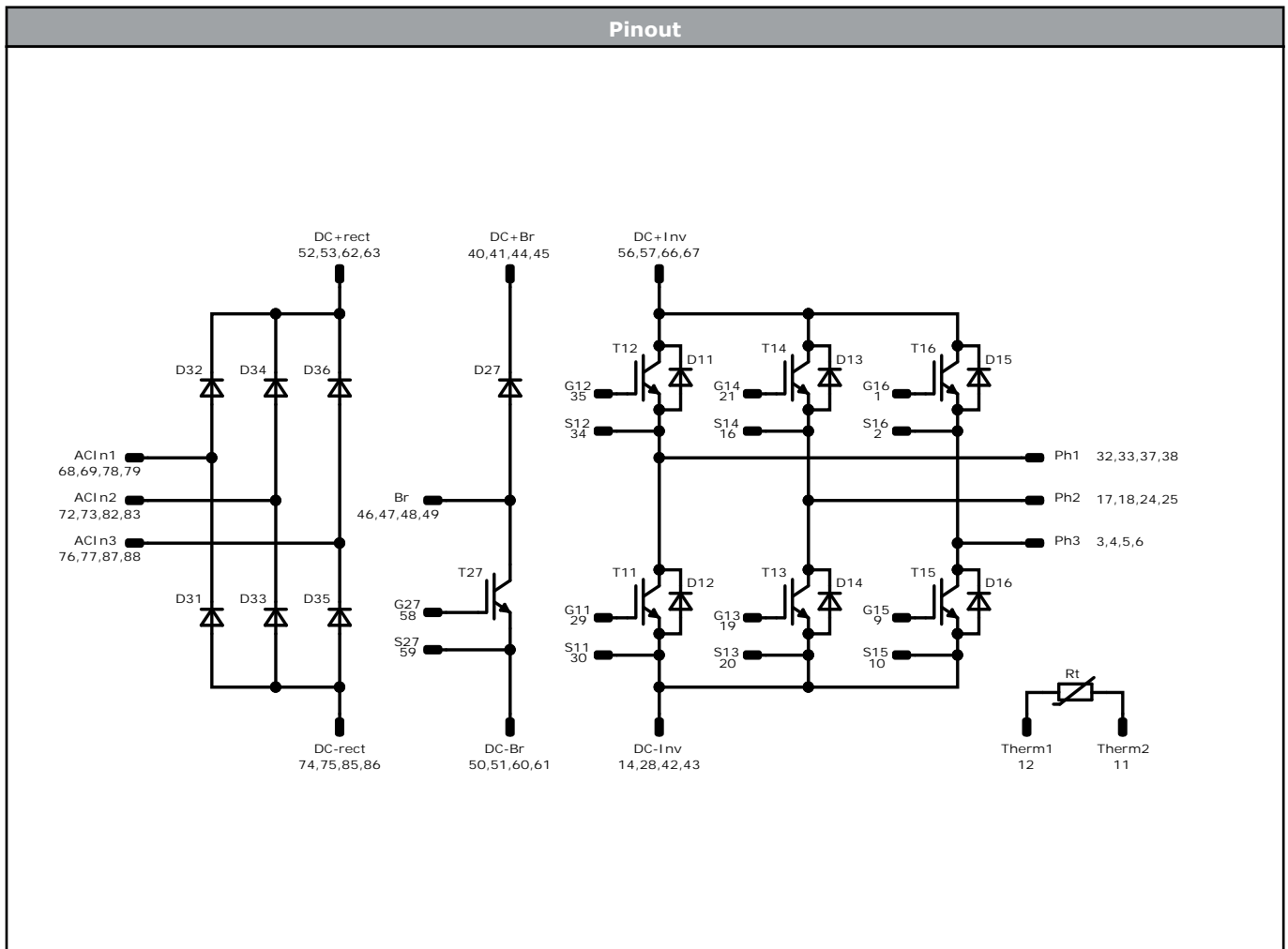

Identification					
ID	Component	Voltage	Current	Function	Comment
T11, T12, T13, T14, T15, T16	IGBT	1200 V	100 A	Inverter Switch	
D11, D12, D13, D14, D15, D16	FWD	1200 V	100 A	Inverter Diode	
T27	IGBT	1200 V	100 A	Brake Switch	
D27	FWD	1200 V	100 A	Brake Diode	
D31, D32, D33, D34, D35, D36	Rectifier	1600 V	75 A	Rectifier Diode	
Rt	Thermistor			Thermistor	



Packaging instruction				
Standard packaging quantity (SPQ) 48	>SPQ	Standard	<SPQ	Sample

Handling instruction
Handling instructions for MiniSKiiP® 3 packages see vincotech.com website.

Package data
Package data for MiniSKiiP® 3 packages see vincotech.com website.

Vincotech thermistor reference
See Vincotech thermistor reference table at vincotech.com website.

UL recognition and file number
This device is certified according to UL 1557 standard, UL file number E192116. For more information see vincotech.com website. 

Document No.:	Date:	Modification:	Pages
80-M312PMA100M7-K420A70-D3-14	16 Jun. 2022	Correction of Zth curves	
80-M312PMA100M7-K420A70-D4-14	15 Sep. 2022	Correction of Gate charge unit	

**DISCLAIMER**

The information, specifications, procedures, methods and recommendations herein (together "information") are presented by Vincotech to reader in good faith, are believed to be accurate and reliable, but may well be incomplete and/or not applicable to all conditions or situations that may exist or occur. Vincotech reserves the right to make any changes without further notice to any products to improve reliability, function or design. No representation, guarantee or warranty is made to reader as to the accuracy, reliability or completeness of said information or that the application or use of any of the same will avoid hazards, accidents, losses, damages or injury of any kind to persons or property or that the same will not infringe third parties rights or give desired results. It is reader's sole responsibility to test and determine the suitability of the information and the product for reader's intended use.

**LIFE SUPPORT POLICY**

Vincotech products are not authorised for use as critical components in life support devices or systems without the express written approval of Vincotech.

As used herein:

1. Life support devices or systems are devices or systems which, (a) are intended for surgical implant into the body, or (b) support or sustain life, or (c) whose failure to perform when properly used in accordance with instructions for use provided in labelling can be reasonably expected to result in significant injury to the user.
2. A critical component is any component of a life support device or system whose failure to perform can be reasonably expected to cause the failure of the life support device or system, or to affect its safety or effectiveness.